

 **REGAL**



# **OWNER'S MANUAL**

## **2800**

REGAL# 281514

5-2015

## FUEL SYSTEMS

Boats manufactured for use in California for model year 2018 and after meet the California EVAP Emissions regulation for spark-ignition marine watercraft. Boats meeting this requirement will have a label affixed near the helm.

 <b>WARNING</b>	
<p><b>Operating, servicing and maintaining a recreational marine vessel can expose you to chemicals including engine exhaust, carbon monoxide, phthalates, and lead, which are known to the State of California to cause cancer and birth defects or other reproductive harm. To minimize exposure, avoid breathing exhaust, service your vessel in a well-ventilated area and wear gloves or wash your hands frequently when servicing this vessel. For more information go to: <a href="http://www.P65warnings.ca.gov/marine">www.P65warnings.ca.gov/marine</a>.</b></p>	

The fuel system in this boat complies with U.S. EPA mandated evaporative emission standards at time of manufacture using certified components.

**CALIFORNIA EVAPORATIVE EMISSION CONTROL  
WARRANTY STATEMENT**

**YOUR WARRANTY RIGHTS AND OBLIATIONS**

The California Air Resources Board and Regal Marine Industries Inc. are pleased to explain the evaporative emission control system warranty on your Model Year 2018 spark-ignition marine watercraft. In California, new spark-ignition marine watercraft must be designed, built, and equipped to meet the States stringent anti-smog standards. Regal Marine Industries must warrant the evaporative emission control system on your spark ignition marine watercraft for the person listed below provided there has been no abuse, neglect or improper maintenance of your spark-ignition marine watercraft.

Your evaporative emission control system may include parts such as carburetors, fuel tanks, fuel lines, fuel caps, valves, canisters, filters, vapor hoses, clamps connectors and other associated components.

**MANUFACTURER'S WARRANTY COVERAGE:**

This evaporative emission control system is warranted for two years. If any evaporative emission-related part on your spark-ignition marine watercraft is defective, the part will be repaired by Regal Marine Industries Inc.

**OWNER'S WARRANTY RESPONSIBILITIES:**

- As the spark ignition marine watercraft owner, you are responsible for the performance of the required maintenance listed in your owner's manual. Regal Marine Industries Inc. recommends that you retain all receipts covering maintenance on your, but Regal Marine Industries Inc. cannot deny warranty solely on the lack of receipts.
- As the owner, you should however be aware that Regal Marine Industries Inc. may deny you warranty coverage of your spark-ignition marine watercraft or a part has failed due to abuse, neglect, or improper maintenance or unapproved modifications.
- You are responsible for presenting your spark-ignition marine watercraft to a Regal Marine industries distribution center or a service center as soon as the problem exists. The warranty repairs should be completed in a reasonable amount of time, not to exceed 30 days. If you have a question regarding your warranty coverage, you should contact Regal Marine Industries Inc. at 407-851-4360.

**13 CCR 2861 PARTS LIST:**

Evaporative System Parts List Includes:

Canisters – US EPA Evaporative family names -HDPHMDRNT10 & HDPHMDRNN10

Fuel Hose - CARB Component Executive Order #'s RM-17-003 & RM-17-008

Fuel Tanks - (Aluminum)

Deck Fills – EPA Compliant

Fuel Vent - P-TRAP ISO 10088 Compliant

Primer Bulb -- Low Perm EPA & CARB Certified – EPA #GATWPLINE121-008

THIS PAGE IS LEFT INTENTIONALLY BLANK



---

## INTRODUCTION

Your Regal Owner's Manual	
General Information	
Regal Warranty	

## 1 SAFETY ON BOARD

Safety Labels	1-1
General Boating Safety	1-3
Required Safety Equipment	1-7
Fire Extinguishers	1-10
Visual Distress Signals	1-12
Sound Protecting Devices	1-15
Navigation Lights	1-15
Pollution Regulations	1-17
Marine Sanitation Devices	1-17
Exhaust & Carbon Monoxide	1-21
Boating Under The Influence	1-25
Boating Accidents	1-27
Water Sports	1-29
Weather & Water Conditions	1-34

## 2 RULES OF THE ROAD

Navigation Rules Defined	2-1
Navigation Rules	2-2
Night Running	2-9
Bridge Clearance	2-10

## 3 ENGINES & CONTROLS

Engines	3-1
Propulsion	3-4
Controls	3-7

## 4 SYSTEMS

Electrical	4-1
Fuel	4-13
Water	4-18
Waste	4-20

## 5 VESSEL OPERATION

Getting Underway	5-1
Fueling	5-3
Starting & Stopping	5-6
Steering	5-8
Fenders	5-10
Dock Line Basics	5-11
Stern Drive Systems	5-15
Stern Drive Maneuvering	5-17
Trim Angle	5-20
Anchoring	5-25
Towing	5-26
Emergencies	5-29
First Aid	5-30
Hypothermia	5-31
Environmental Awareness	5-32

# Table Of Contents

---

## 6 EQUIPMENT OPERATION

Air Compressor (Inflator)	6-2	Toilet	6-113
Anchor Windlass	6-3	Trim Tabs	6-120
Automatic Fire Extinguisher	6-9	Underwater Lights	6-124
Battery	6-13	Water Heater	6-125
Battery Charger	6-14	Windshield	6-126
Battery Management Center	6-20		
Bilge Pump	6-24		
Blower	6-25		
Board Racks	6-26		
Bow Filler Cushion	6-27		
Bow Scuff Plate	6-28		
Bow Thruster	6-29		
Bow Walk-Through Doors	6-30		
Breaker Panels	6-31		
Canvas	6-36		
Cockpit Carpet	6-56		
Cockpit Heater	6-58		
Cockpit Refrigerator	6-59		
Cockpit Seagrass Mat	6-60		
Cockpit Table	6-61		
Depth Finder	6-62		
Docking Lights	6-65		
Drain Plug	6-66		
Engine Hatch	6-67		
Fresh Water System	6-68		
Gas Vapor Detector	6-70		
Gray Water System	6-73		
Grill	6-74		
Ladders	6-79		
Lighting	6-81		
Power Platform	6-82		
Power Tower	6-83		
Rear View Mirror	6-88		
Refreshment Center-Head	6-89		
Regal Vue Display	6-90		
Seating	6-94		
Sirius Satellite Radio	6-95		
Ski Tow Pylon	6-96		
Stereo	6-97		
Swim Platform	6-111		

## 7 COSMETIC CARE & MAINTENANCE

Cosmetic Care	7-1
Maintenance	7-12

## 8 TROUBLESHOOTING

Diagnostic Charts	8-1
-------------------	-----

## 9 STORAGE/WINTERIZATION

Decommissioning Checklist	9-2
Recommissioning Checklist	9-5

## 10 GLOSSARY & INDEX

Glossary	10-1
Index	10-5

## 11 TECHNICAL INFORMATION



## *Introduction*

---

*Dear Regal Owner,*

*I know I speak for everyone at Regal when I welcome you to the ever-growing family of Regal boat owners. You've chosen a craft that is recognized worldwide for its standard of excellence. Each step in construction has been carefully scrutinized to assure comfort, performance, reliability and safety for both your passengers and yourself.*

*Your boat is certified by the National Marine Manufacturers Association. It also complies with the applicable standards set by the United States Coast Guard and the American Boat and Yacht Council. Your Regal boat was built with the same attention to detail and quality of construction that we would expect in a boat we would purchase ourselves.*

*Whether you're a veteran boater or a newcomer, we strongly urge you to read this boat owner's manual thoroughly. Familiarize yourself with the various components of your boat, and heed the safety precautions noted herein.*

*If you have questions that are not covered in this manual, please consult your authorized Regal dealer for assistance or phone the Regal factory at 407-851-4360.*

*Thank you, and welcome to the "World of Regal!"*

*Duane Kuck*

*President*



---

*Mission Statement*

*With God's help*

*and a steadfast commitment to integrity,*

*we will develop a team*

*of exceptional people and relationships*

*to provide*

*exceptional customer satisfaction.*





## Introduction



Boating is becoming more popular every year. There are numerous types of recreational vessels on our waterways today involved in an every growing number of activities. Therefore, as a new boat owner it is of the highest priority to learn about general boating practices

before operating your craft.

Your Regal dealer will answer many questions and provide valuable “hands on” information during the completion of the new boat delivery process. In addition, your dealer has received special factory training on the product line and his services should be employed to solve technical problems and periodic maintenance beyond the scope of this manual. Also, your Regal dealer carries a line of factory approved parts and accessories.

Your Regal dealer can provide information regarding national training organizations such as the U.S. Power Squadron and United States Coast Guard Auxiliary. Along with other organizations and literature, they can help build your “boating savvy” by developing the necessary skills and awareness to be a safe and competent skipper. Your local library can also help in providing recommended boating literature such as Chapman Piloting (Seamanship & Boat Handling by Elbert S. Maloney).

Remember, the waterways can change from normal to abnormal conditions in a heartbeat. Knowing how to react quickly comes from experience and knowledge which can be gained through boating education.

Welcome aboard!



---

## YOUR REGAL OWNER'S MANUAL

Your Regal owner's manual has been developed to assist you in operating your vessel with safety and pleasure. Be sure to read and become familiar with the contents before operating your craft. Your owner's manual has been divided into general chapters to assist you in becoming more familiar with your Regal boat. Also, a technical section is featured which can be valuable in troubleshooting. This manual is not intended to be a complete source of boating maintenance, boat handling techniques, boating safety or seamanship. These skills require education and experience levels beyond this manual.

**In keeping with its commitment to continued improvement, Regal notes that all drawings, specifications, models, standard and optional equipment referred to in this manual are subject to change without notice.** *A portion of the equipment described may not be installed on your boat or the pictorials may not exactly match your components. Selected illustrations in this owner's manual may represent typical examples.*

## OWNER'S INFORMATION PACKET

Regal has provided an information pouch aboard the vessel. Read and become familiar with the materials. This packet contains valuable literature on your propulsion package, standard and optional equipment, systems and various care, cleaning and maintenance instructions. Be sure to store the information pouch in a clean dry area.

## GENERAL INFORMATION

### Hull Identification Number (HIN) ---

The United States Coast Guard has established a universal system of numerically identifying vessels by using a hull identification number or "HIN." This number identifies your Regal boat model, hull number, month and year of manufacture.



## Introduction

---

The HIN is normally found in the vicinity of the starboard transom rub rail. The domestic HIN consists of 12 alpha or numeric characters. It is recommended that you locate and write down the HIN for future reference. It can be especially useful when ordering parts from your Regal dealer. A second HIN number is found in a hidden location. This second HIN is useful to authorities if for example the boat is stolen and the original transom HIN is unreadable or eliminated.

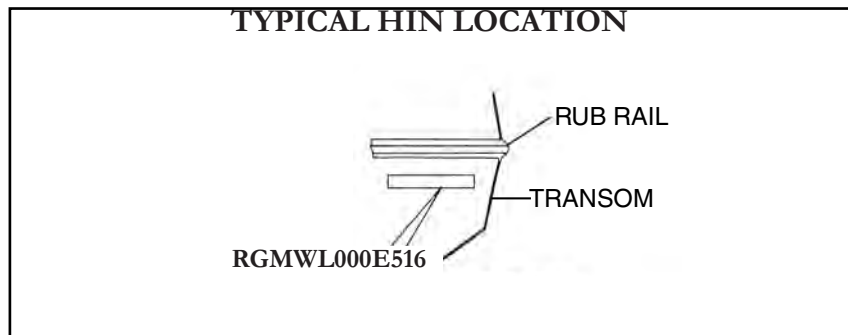

### Vessel Information Sheet

---

It is recommended that you fill out the information on the following page. It will supply vital statistics on your vessel. Make a copy of the data for safe keeping at home.

### Vessel Float Plan

---



Fill out the float plan on the following page before departing. Leave it with a responsible person who will notify the United States Coast Guard or local law enforcement authorities if you do not return as planned. If you change your plans be sure to notify this person. Make copies of the float plan and use one each time you go boating. This will help people know where to find you should you not return on schedule. Do not file the plan with the USCG.



---

## VESSEL INFORMATION SHEET

Owner: \_\_\_\_\_

Address: \_\_\_\_\_

City & State: \_\_\_\_\_

Home Phone: \_\_\_\_\_ Business Phone: \_\_\_\_\_

In Case Of Emergency Notify: \_\_\_\_\_

Address: \_\_\_\_\_

City: \_\_\_\_\_ State: \_\_\_\_\_

Phone: \_\_\_\_\_

Insurance Agent's Name: \_\_\_\_\_

Policy#: \_\_\_\_\_

USCG Phone: \_\_\_\_\_ Local Police: \_\_\_\_\_

Marina Phone: \_\_\_\_\_ Slip (Dock#): \_\_\_\_\_

Hull Serial #: RGM \_\_\_\_\_

Key #: \_\_\_\_\_ Engine Serial #: \_\_\_\_\_

Sterndrive Serial #: \_\_\_\_\_

Key #: \_\_\_\_\_ Cabin Door: (If Applicable) \_\_\_\_\_

Selling Dealer: \_\_\_\_\_

Address: \_\_\_\_\_

City & State: \_\_\_\_\_

Phone: \_\_\_\_\_

Servicing Dealer: \_\_\_\_\_

Address: \_\_\_\_\_

City & State: \_\_\_\_\_

Phone: \_\_\_\_\_





---

## LAUNCH & CRUISE CHECKLIST

- Obtain a current weather report.
- Inspect the hull and propeller for damage.
- Check all electrical system switches for proper operation.
- If your boat has been in the water, run the bilge pump until the flow of water stops.
- If your boat has been out of the water, check to see that all bilge water has drained out. Install the drain plug.
- Check that all required safety equipment is on board and in good working condition.
- Check that all other equipment is on board such as mooring lines, first aid kit, tool kit and extra parts.
- Open engine compartment. Inspect for fuel odors and visible leaks in the fuel, oil, exhaust & power steering systems.
- Visually inspect engine for cracked hoses, defective belts, loose fasteners such as bolts, nuts and hose clamps.
- Check fuel level. Fuel tanks should be filled to near full capacity.
- Make sure all navigation charts, equipment and vessel registration paperwork are onboard.
- Check operation of bilge blower, steering system, navigation lights and horn.
- Make sure passengers and crew know how to operate safety equipment and react to an emergency.
- File a float plan with a responsible party ashore.



---

### **SUGGESTED TOOLS, PARTS & GEAR**

#### **SUGGESTED TOOLS**

Allen Wrenches  
Jack Knife  
Phillips Screwdriver Set  
Slotted Screwdriver Set  
Regular Pliers  
Combination Wrench Set  
Ratchet & Socket Set  
Hammer  
Wire Crimpers  
Vise Grip Pliers  
Floating Flashlight  
Nut Driver Set  
Oil Filter Wrench  
Fuel Filter Wrench  
Tape Rule

#### **SPARE PARTS**

Fuel Filter  
Spark Plugs  
Water Pump Belt  
Propellers (Set)  
Alternator Belt  
Anti-Siphon Set  
Propeller Nut & Hardware  
Penetrating Oil  
Extra Light Bulbs  
Extra Batteries  
Duct Tape  
Electrical Tape, Connectors  
Power Steering Fluid  
Water Pump Impeller  
Spare Keys On Floater

#### **BASIC GEAR**

Tie Lines  
Mooring Lines  
Dock Fenders  
First Aid Kit  
Boat Hook  
Foul Weather Gear  
VHF Radio, EPIRB, GPS, Cell Phone  
Charts & Plotting Instruments  
Emergency Water & Food  
Bailer Or Hand Pump  
Extra Fire Extinguisher  
Personal Flotation Devices  
Anchor & Line  
Life Raft



---

## Yacht Plate

At the helm area on Regal boats **26' and longer** is located a yacht plate as shown below. This plate represents manufacturers who participate in the National Marine Manufacturer's Association yacht certification program. This program goes beyond the minimum USCG standards to ensure adherence to the American Boat & Yacht Council (ABYC) standards. NMMA approved inspectors are utilized to verify compliance to these standards.

Note the yacht plate information below:

- The operator of the craft must read and understand the plate information before operating the vessel.
- **The boat operator is responsible for the vessel and the safety of his passengers.**

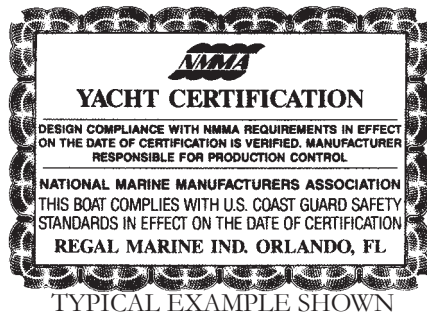

---

## Safe Loading

The vessel operator is responsible for his passengers. Follow the seat position illustration in the technical section of this manual. Explain to all passengers before the outing the importance of keeping the overall load balanced. Also, emphasize that passengers must remain seated while the vessel is in motion for the safety of the other passengers. Make sure that all passengers are positioned in their seats to afford clear visibility for the operator in all directions. Appoint passengers as “lookouts” for the operator and to signal before a dangerous situation develops.





## *Introduction*

---

### **Owner's Registration & Systems Checklist** ---

Please note that your Regal boat requires the proper registration by your authorized Regal dealer. To initiate your warranty the dealer must complete the owner's registration form and systems checklist at the time of delivery. The owner must sign the paperwork to acknowledge that the dealer has reviewed the boat systems and warranty provisions with the owner. The owner should keep the original paperwork that features a temporary warranty registration. A Regal express limited warranty certificate containing all relevant boat and engine serial numbers will be sent after the factory receives the paperwork.

### **Dealer's Responsibility** ---

Your boat has undergone rigid quality assurance inspections before leaving the factory. However, your dealer has been trained to perform final pre-delivery checks and to service your Regal boat prior to your pick-up. Your dealer's responsibilities include:

- A complete orientation in the operation of your Regal boat, including matters relating to the safe operation of your craft.
- Completion and mailing of your boat registration warranty form to Regal.
- Warranties, registration materials, owner's manual, operation, installation and maintenance instructions for all auxiliary equipment supplied with or installed on your Regal boat.



---

## **Owner's Responsibility**

---

You are entitled to all the benefits and services outlined in your Regal boat warranty. However, you have certain responsibilities to ensure warranty satisfaction. These are:

- To read the warranty materials and understand them fully.
- To examine the boat in detail at the time of delivery.
- Apply the following: boating rules and regulations, safety equipment, environmental regulations, accident reports and warranty regulations terms and conditions.
- To read thoroughly all literature supplied with your boat, including this owner's manual and to follow the recommendations in the literature.
- To return the boat after the recommended hours of engine operation for the proper dealer service inspections.
- To provide proper maintenance and periodic servicing of your boat and equipment as set forth in the various manuals supplied.



# Introduction



## RUNABOUTS and CUDDY NEW BOAT DELIVERY CHECKLIST

REGAL MARINE INDUSTRIES  
2300 JETPORT DRIVE  
ORLANDO, FLORIDA 32809  
(407) 851-4360

### OWNER REGISTRATION INFORMATION

NAME \_\_\_\_\_ DEALER \_\_\_\_\_  
 ADDRESS \_\_\_\_\_ HULL # \_\_\_\_\_  
 CITY \_\_\_\_\_ STATE \_\_\_\_\_ ZIP \_\_\_\_\_ MODEL \_\_\_\_\_  
 COUNTRY \_\_\_\_\_ PHONE # \_\_\_\_\_ EMAIL \_\_\_\_\_

**INSTRUCTIONS:** This checklist is designed to assist dealers in the delivery of a Regal Boat to a new owner. Review the location, operation and maintenance of each item noted below with the owner and acknowledge this by checking the appropriate boxes. Indicate if item is not applicable with "NA". This form must be completed and signed by the dealer's representative and the customer to acknowledge proper receipt of the boat. The warranty will not be activated until a fully completed and signed copy has been received by Regal Marine.

<b>A. NEW BOAT INFORMATION</b> 1. Review Regal's warranty 2. Review Engine warranty 3. Review Regal's owner manual 4. Review owner's package 5. Review dealer's service procedures 6. Review owner's service responsibilities	DEALER _____ OWNER _____ _____ _____ _____ _____ _____ _____	<b>D. INSTRUMENTATION</b> 1. Function of all gauges 2. Function of all switches 3. Throttle & shifter 4. Steering 5. Ignition 6. Operation of all optional electronics	DEALER _____ OWNER _____ _____ _____ _____ _____ _____ _____
<b>B. CABIN (IF APP)</b> 1. Location of all storage areas 2. Cabin lighting 3. Deck hatch 4. Port hole 5. Carbon monoxide detector 6. Dinette table set up 7. Cabin cushions set up 8. Electrical panel 9. Toilet / head 10. Water system	DEALER _____ OWNER _____ _____ _____ _____ _____ _____ _____ _____ _____	<b>E. ENGINE ROOM</b> 1. Engine fluid check 2. Trim pump location / fluid check 3. Battery I 4. Battery switch (may be in cockpit) 5. Bilge pump 6. Trim tab pump 7. Fire extinguisher 8. Blower	DEALER _____ OWNER _____ _____ _____ _____ _____ _____ _____ _____
<b>C. COCKPIT</b> 1. Swim ladder 2. Transom shower 3. Cockpit seating set up 4. Engine hatch operation 5. Cockpit storage areas 6. Refreshment center 7. Fishing package	DEALER _____ OWNER _____ _____ _____ _____ _____ _____ _____	<b>F. CANVAS</b> 1. Canvas set up 2. Canvas storage 3. Canvas care and cleaning	DEALER _____ OWNER _____ _____
		<b>L. CARE &amp; CLEANING</b> 1. Vinyl uph. care & cleaning 2. Windshield care & cleaning 3. Gel coat care & cleaning 4. Stainless steel hardware care & cleaning 5. Toilet system care & cleaning	DEALER _____ OWNER _____ _____ _____ _____ _____ _____

**CAUTION:** This checklist is only intended to provide a general overview and does not represent all information necessary for proper operation of the boat. It is very important that persons operating this boat study the various manuals and materials provided with the boat and follow the recommendations contained in these materials. They contain important information including cautions and warnings that are vital to safe and enjoyable operation of the vessel. It is the owner's responsibility to insure that anyone operating the boat has been properly trained.

We have completed a review and orientation of the boat and its systems. The boat is in order and functioning properly with the exception of any items specifically noted above. This confirms that owner has received a copy of the Regal Limited Lifetime Warranty and engine manufacturer's warranty and agrees to these warranty terms and conditions.

DEALER REPRESENTATIVE \_\_\_\_\_ DELIVERY DATE \_\_\_\_\_  
 OWNER \_\_\_\_\_ DATE \_\_\_\_\_



---

## REGAL MARINE INDUSTRIES, INC. LIFETIME PLUS LIMITED HULL WARRANTY

Welcome to the Worldwide Family of Regal Owners! We are very pleased that you have chosen a Regal Powerboat!

This document is your Warranty Registration Certificate and Statement of Warranty. Please check the registration information section for accuracy. If this information is not correct or if you change your address at some future date, please notify us at the following address: Regal Marine Industries, Inc. Attention: Warranty Registrations, 2300 Jetport Drive, Orlando, Florida 32809

Please read the warranty carefully. It contains important information on Regal's claims procedures and your rights and obligations under this warranty.

**WHAT IS COVERED:** This Limited Warranty applies only to Regal boats beginning with model year 2013.

**LIFETIME LIMITED STRUCTURAL HULL WARRANTY:** Regal Marine Industries, Inc. warrants to the original retail purchaser of this boat if purchased from an authorized Regal dealer that the selling dealer or Regal will repair or replace the fiberglass hull if it is found to be structurally defective in material or workmanship for as long as the *original* retail purchaser owns the boat. For purposes of this warranty, the hull is defined as the single fiberglass casting which rests on the water. This limited warranty is subject to all limitations and conditions explained below.

**FIVE-YEAR TRANSFERABLE LIMITED STRUCTURAL HULL WARRANTY:** In addition to the Lifetime Limited Structural Hull Warranty, Regal offers a Transferable Five-Year Limited Structural Hull Warranty. Under the Five-Year Transferable Limited Structural Hull Warranty, Regal will repair or replace the fiberglass hull if it is found to be structurally defective in material or workmanship within the first (5) years after the date of delivery to the original retail purchaser. Any remaining term of this Five-Year Limited Hull Warranty may be transferred to a second owner if within 60 days of purchase, the new owner registers the transfer with Regal and pays the established warranty transfer fee. Contact Regal Customer Service at the above address for details.

**FIVE-YEAR LIMITED HULL BLISTER WARRANTY:** Regal will Warrant to the original retail purchaser, any underwater gelcoated surfaces of the hull against laminate blisters which occur as a result of defects in material or workmanship within (5) years of the date of delivery, provided that the original factory gelcoat surface has not been altered. Alternation would include but is not limited to damage repair; excessive sanding, scraping, sandblasting; or from improper surface preparation for application of a marine barrier coating or bottom paint, any of which shall void this Five-Year Limited Hull Blister Warranty. Regal Marine shall repair or cause to be repaired any covered laminate blisters based on the following prorated schedule. Less than two (2) years from delivery date - 100%, Two (2) to three (3) years from delivery date - 75%, Three (3) to four (4) years from delivery date - 50%, Four (4) to five (5) years from delivery date - 25%.

Reimbursement shall be limited to one repair, not to exceed (\$80.00) dollars per foot of boat length prior to prorating. Regals prior authorization for the method and cost of repair, must be obtained before repairs are commenced. All costs to transport the boat for repairs are the responsibility of the owner.



## Introduction

---

**LIMITED GENERAL WARRANTY:** In addition to above hull warranties, Regal warrants to the original purchaser of this boat if purchased from an authorized dealer that the dealer or Regal will repair or replace any parts found to be defective in materials or workmanship for a period of one (1) year from the date of delivery, subject to all limitations and conditions contained herein.

**LIMITED EXTERIOR FINISH WARRANTY:** Regal warrants that the selling dealer or Regal will repair cosmetic defects in the exterior gelcoated finish including cracks or crazing reported to Regal within 90 days from the date of delivery to the original purchaser, subject to all limitations and conditions contained herein. All warranty work is to be performed at a Regal dealership or other location authorized by a Regal Customer Service Manager after it is established to Regal's satisfaction that there is a defect in material or workmanship.

### **REGISTRATION INFORMATION:**

**CUSTOMER OBLIGATIONS:** The following are conditions precedent to the availability of any benefits under these limited warranties:

(a) The purchaser must sign and the dealer must submit to Regal the "OWNER REGISTRATION AND SYSTEMS CHECKLIST

FORM within ten (10) days of the date of delivery and such information must be on file at Regal.

(b) The purchaser must first notify the dealer from whom the boat was purchased of any claim under this warranty within the applicable warranty period and within a reasonable period of time (not to exceed thirty (30) days) after the defect is or should have been discovered.

(c) Regal will not be responsible to repair or replace any part, (1) if the use of the boat is continued after the defect is or should have been discovered; and (2) if such continued use causes other or additional damage to the boat or component parts of the boat.

(d) Based on the dealer's knowledge of Regal's warranty policy and/or consultations with Regal, the dealer will accept the claim and arrange for appropriate repairs to be performed, or deny the claim if it is not within the warranty.

(e) The dealer will contact the Regal boat owner regarding instructions for delivery of boat or part for warranty repair if it is covered by the limited warranty.

**ALL COSTS TO TRANSPORT THE BOAT FOR REPAIRS ARE THE RESPONSIBILITY OF THE OWNER;**

(f) If the Regal boat owner believes a claim has been denied in error or the dealer has performed the warranty work in an

unsatisfactory manner, the owner must notify Regal's Customer Service Department in writing at the address listed for further consideration. Regal will then review the claim and take appropriate follow-up action.



---

**WARRANTY EXCEPTIONS: THIS LIMITED WARRANTY** does not cover and the following are not warranted:

- (a) Engines, metal plating or finishes, windshield breakage, leakage, fading and deterioration of paints, canvas, upholstery and fabrics;
- (b) Gelcoat surfaces including, but not limited to, cracking, crazing, discoloration or blistering except as noted above;
- (c) Accessories and items which were not part of the boat when shipped from the Regal factory, and/or any damage caused thereby;
- (d) Damage caused by misuse, accident, galvanic corrosion, negligence, lack of proper maintenance, or improper trailering;
- (e) Any boat used for racing, or used for rental or commercial purposes;
- (f) Any boat operated contrary to any instructions furnished by Regal, or operated in violation of any federal, state, Coast Guard or other governmental agency laws, rules, or regulations;
- (g) The limited warranty is void if alterations have been made to the boat;
- (h) Transportation of boat or parts to and/or from the REGAL factory or service location;
- (i) Travel time or haul outs, loss of time or inconvenience;
- (j) Any published or announced catalog performance characteristics of speed, fuel and oil consumption, and static or dynamic transportation in the water;
- (k) Any boat that has been re-powered beyond Regal's power recommendations;
- (l) Boats damaged by accident and boats damaged while being loaded onto, transported upon or unloaded from trailers, cradles, or other devices used to place boats in water, remove boats from water or store or transport boats on or over land;
- (m) Water damage to, dry rot to, condensation to, or absorption by interior surfaces, wood structures or polyurethane foam; interior wood including, but not limited to, bleeding and/or discoloration as a result of condensation or moisture or water continually contacting the plywood causing staining to upholstery, carpet or other interior surfaces;
- (n) Costs or charges derived from inconveniences or loss of use, commercial or monetary loss due to time loss, and any other special, incidental or consequential damage of any kind or nature whatsoever.

**NO WAIVER OF THESE TERMS:** The terms, conditions, limitations and disclaimers contained herein cannot be waived except by the Customer Service Manager of Regal. Any such waiver must be in writing. Neither the dealer, nor the customer, nor any service, sales and/or warranty representative of Regal is authorized to waive and/or modify these conditions, limitations and/or disclaimers.

**GENERAL PROVISIONS:**

**ALL GENERAL, SPECIAL, INDIRECT, INCIDENTAL AND/OR CONSEQUENTIAL DAMAGES ARE EXCLUDED FROM THIS WARRANTY AND ARE TOTALLY DISCLAIMED BY REGAL. IT IS THE INTEREST OF THE PARTIES THAT THE OWNER'S SOLE REMEDY IS THE REPAIR OR REPLACEMENT OF THE VESSEL OR ITS ALLEGEDLY DEFECTIVE COMPONENT PARTS AND THAT NO OTHER LEGAL OR EQUITABLE REMEDIES SHALL BE AVAILABLE TO SAID OWNER. SOME STATES DO NOT ALLOW THE EXCLUSION OF INCIDENTAL OR CONSEQUENTIAL DAMAGES SO THE FOREGOING MAY NOT APPLY TO YOU.**



## *Introduction*

---

**THIS IS A LIMITED WARRANTY; REGAL MAKES NO WARRANTY, OTHER THAN CONTAINED HEREIN; TO THE EXTENT ALLOWED BY LAW ANY WARRANTIES OF MERCHANTABILITY OR FITNESS FOR A PARTICULAR PURPOSE ARISING IN STATE LAW ARE EXPRESSLY EXCLUDED TO THE EXTENT ALLOWED BY LAW. ANY IMPLIED WARRANTY OF MERCHANTABILITY IS LIMITED TO THE PERIOD OF THIS LIMITED WARRANTY. ALL OBLIGATIONS OF REGAL ARE SPECIFICALLY SET FORTH HEREIN. REGAL DOES NOT AUTHORIZE ANY PERSON OR DEALER TO ASSUME ANY LIABILITY IN CONNECTION WITH REGAL BOATS.**

Some states do not allow limitations on how long an implied warranty lasts, so the above limitation may not apply to you. Regal's obligation with respect to this warranty is limited to making repairs to or replacing the defective parts and no claim for breach of warranty shall be cause for cancellation or rescission of the contract or sale for any boat manufactured by REGAL MARINE INDUSTRIES, INC.

Regal will discharge its obligations under this warranty as rapidly as possible, but cannot guarantee any specific completion date due to the different nature of claims which may be made and services which may be required. Regal reserves the right to change or improve the design of its boats without obligation to modify any boat previously manufactured. This limited warranty gives you specific legal rights, and you may also have other rights which may vary from state to state. Regal shall in no way be responsible for any repairs not **PRE-AUTHORIZED** by a Regal Customer Service Manager or repairs performed by a repair shop not **PRE- AUTHORIZED** by a Regal Customer Service Manager.



# Safety On Board



Safety awareness can't be over emphasized. Safety on board needs to be the skipper's number one priority. In this manual you will find many safety precautions and symbols to identify safety related items. Heed all safety precaution information.

**Remember, the skipper is responsible for the safety of his passengers and**

**crew.** Safety precautions are stated as caution, warning and danger signal words. They are highlighted in this manual by font design and symbol usage. Also, a notice heading is included which provides operation and maintenance information but is not hazard-related.

## SAFETY LABELS

### Safety Precaution Definition

Become familiar and understand all safety precaution labels!

	<b>DANGER</b>
IMMEDIATE HAZARDOUS SITUATION THAT, IF NOT AVOIDED, <b>WILL</b> RESULT IN DEATH OR SERIOUS INJURY.	

	<b>WARNING</b>
POTENTIALLY HAZARDOUS SITUATION THAT, IF NOT AVOIDED, <b>COULD</b> RESULT IN DEATH OR SERIOUS INJURY.	





## CHAPTER 1

---



### CAUTION

Indicates a potentially hazardous situation or unsafe practice that, if not avoided, **may** result in injury or property or product damage.

### NOTICE

General or specific information which is important to correct operation or maintenance, **but is not hazard related.**

#### Precautionary Labels

---

Read and understand all safety labels affixed to your Regal boat. Most of the safety labels are found close to the helm, aft cockpit and or swim platform. The location of the labels may vary by model and the label list does not cover everything! Use common sense to analyze the result of an action on board your vessel. **Always think safety first!**

### NOTICE

DO NOT REMOVE OR COVER ANY  
PRECAUTIONARY LABELS.  
KEEP HARSH CHEMICALS AWAY FROM LABELS.  
IF A LABEL BECOMES ILLEGIBLE,  
CONTACT YOUR REGAL DEALER  
FOR ORDERING REPLACEMENTS.



## *Safety On Board*

---

### **GENERAL BOATING SAFETY**

We understand that you are eager to get your Regal boat on the water. However, we strongly suggest that you thoroughly familiarize yourself and friends or members of your family with safe boating practices before setting out.

Remember, that along with the freedom and exhilaration of boating comes the responsibility that you have for the safety of your passengers and other boaters who share the water with you.

Boating regulations vary from state to state. Check with your local state and local authorities for the regulations pertaining to your area.

☐ Check with local weather stations, the U. S. Coast Guard, or weather station broadcasts for the latest conditions. Remember getting caught in severe weather is hazardous, Check weather conditions periodically while you are boating and before your outing. If you are forced to operate your boat in a storm condition, take common sense precautions; wear PFD's, store gear, reduce speed and head for safe refuge.

☐ It is best to avoid operating your boat in foggy weather. When fog sets in, take bearings, log courses and speeds. You are required to emit a five second blast from your horn or whistle once a minute. Also, have your passengers wear PFD's and observe for oncoming vessels.

☐ Operating in shallow water presents a number of hazards including sand bars and water levels influenced by tides. If the vessel strikes an underwater hazard, check for boat and engine damage. If the engine vibrates excessively after striking an underwater obstruction, it may indicate a damaged propeller. If you run aground, seek help by radio or flares.

☐ Make sure your boat and equipment are in top condition. Do this by frequently inspecting the hull, engine and gear.



## CHAPTER 1

---

- You must provide a Coast Guard approved personal flotation device (PFD) for every person on board. These PFD's should be in good condition and easily accessible.
- Insist that non-swimmers and children on board wear a PFD at all times. Any time you encounter rough weather conditions, make sure everyone on board is wearing a PFD, including yourself. Instruct your passengers in how to put on their PFDs and be sure they know their storage location on the boat. Remember, in an emergency, a PFD that cannot be quickly located and worn is useless.
- Never allow anyone to sit anywhere on the boat not specifically designed a seat. While underway, **ALWAYS** insist passengers remain seated.
- **Use maximum caution when fueling.** Never allow any smoke or flame nearby while you are fueling. **ALWAYS** check for fuel leaks and fumes when fueling is completed.



### WARNING

GASOLINE VAPORS CAN EXPLODE.  
BEFORE STARTING ENGINE, OPERATE  
BLOWER 4 MINUTES AND CHECK  
ENGINE COMPARTMENT FOR GASOLINE FUMES  
OR LEAKS. RUN BLOWER MOTOR  
BELOW CRUISING SPEEDS.



### WARNING

USE OF ALCOHOL ENHANCED FUEL, OR ANY FUEL  
OTHER THAN GASOLINE,  
CAN LEAD TO DETERIORATION  
OF THE FUEL SYSTEM COMPONENTS AND/OR  
CAN RESULT IN FIRE AND POSSIBLE EXPLOSION!



## Safety On Board

---



□ **Never drink and drive!** As captain, you are responsible for the safety of your passengers and yourself. Alcohol and boating can be a dangerous combination. **DO NOT** mix them. Alcohol impairs the boat operators ability to make conscious decisions and react to emergency situations quickly.

□ **Never overload your boat!** An overloaded boat, or one with uneven weight distribution can be difficult to steer.

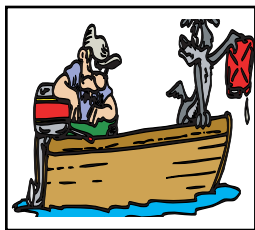

□ **Be certain there is enough fuel aboard for your cruising needs.** Include any reserve that might be needed should you change your plans due to weather or emergency. **Practice the “one-third rule:** (Use one-third of your fuel going out, one-third to return and keep one-third as a reserve).

□ Check the weather before departure. Be particularly cautious of electrical storms and high winds.

□ Have up-to-date charts aboard. You will need current charts of the area you’ll be cruising to stay on proper course. Charts can be obtained at your closest marine outlet or store or by contacting one of three federal government agencies.

□ **File a float plan.** Leave details of your trip with someone responsible who will be remaining on shore. Include expected return, plus name and phone number of a contact person in case of emergency.

□ Use care, courtesy and common sense when launching, docking or operating your boat.



## CHAPTER 1

---

- Learn and obey the “Rules of the Road”. A copy of the “Rules of the Road” can be obtained from the U. S. Coast Guard Auxiliary or local Power Squadron organizations.
  
- In case of emergency: Know the international distress signals if you have a VHF radio aboard. The spoken word **“MAYDAY”** is the international signal of distress and is for emergency use only. Under no circumstances should this word be used, unless there is danger at hand.
  
- Posted speed limits, swimming areas, “no wake” zones and other restrictions should be red-flagged. They are so noted for a reason. Sensible boat use plus courtesy fosters enjoyable and safe boating.
  
- It is your responsibility to stay abreast of all federal, state and local rules, as some laws or regulations may change or be different from state to state. Contact your local boating agencies for updated information.
  
- We can not stress safety enough! Remember, there are no brakes on your boat, and the water current and wind velocity all affect your ability to respond. The driver must use caution at all times to maintain control of his vessel and especially to maintain a safe distance from other boats and obstacles.
  
- Always keep all safety gear in optimum condition. Pay special attention to attached tags and plates indicating expiration dates on equipment such as fire extinguishers, and personal flotation devices. Encourage a periodic maintenance check on all safety equipment. Contact your Regal dealer or marine professional for more information. Again, remember that the captain is responsible for his passengers and vessel.



## Safety On Board

### REQUIRED SAFETY EQUIPMENT

#### Personal Flotation Devices



All personal flotation devices (PFD's) must be Coast Guard approved, in good working condition, and must be the correct size for the wearer. All PFD's must be readily accessible. This means being able to wear them in a reasonable amount of time

in case of an emergency (fire, boat sinking, etc.). They should not be stored or locked in closed areas. Also, make sure that all coverings are removed, such as plastic from any PFD's. Throwable devices such as a ring buoys need to be available for immediate deployment. A PFD should be worn at all times when your boat is operating on the water. A PFD may save your life, but it must be worn to do so.

**As minimum U. S. Coast Guard requirements all recreational boats must carry one type I, II, III, or V PFD (wearable) for each person aboard.** See the explanation following for each type. For type V to be counted they must be used according to the label instructions. In addition, all boats over 16' must carry one Type IV (throwable) PFD. Some states require that PFD's be worn by children of specific ages at all times. Check with state and local boating agencies for particular requirements in your locale before taking children on the water.

Remember PFD's will not necessarily keep you from drowning, even though they are designed to keep a person from sinking. When purchasing PFD's make sure it safely fits the person wearing it. It is a good idea to test PFD's in a shallow pool then take to the water.

Refer to the USCG minimum equipment requirements at the end of this chapter. It is meant to be a guide only. Contact state and local agencies for additional equipment requirements. Remember as the captain of your vessel you are responsible for its safe operation.



## CHAPTER 1

---

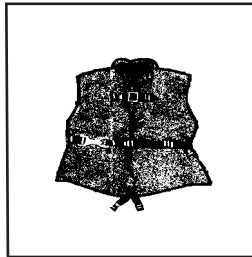

- **TYPE I-** Also known as an offshore jacket, it provides the most buoyancy. It is a PFD for all waters and is especially useful in rough waters where rescue may encompass additional time. It is designed to turn most unconscious users in the water to a face-up position. Type I PFD is available in adult & child sizes.

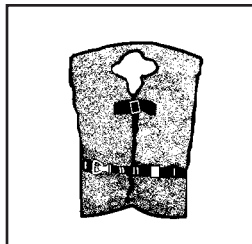

- **TYPE II-** Also known as near-shore buoyant vest, it is recommended for calm, inland water where rescue time will be minimal. It will turn some unconscious people face-up in the water but not as numerous as Type I. They are available in adult, medium child, along with infant and small child sizes.

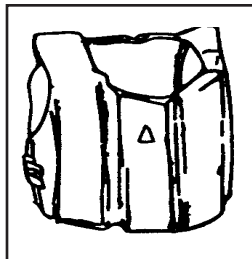

- **TYPE III-** Known as a flotation aid it is good for calm, inland water or where there is a chance for quick rescue. It is designed so wearers can place themselves in a face-up position in the water. The wearer may have to tilt their head back to avoid turning facedown in the water.

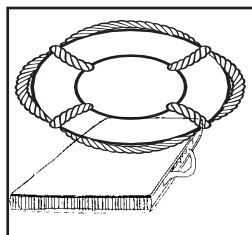

- **TYPE IV-** Intended for calm, inland water with heavy vessel traffic, where help is constantly present. It is designed to be thrown into the water for someone to grab on to and held until rescued. It should *not* be worn. Type IV includes ring buoys, buoyant cushions, and horseshoe buoys.



## Safety On Board

---

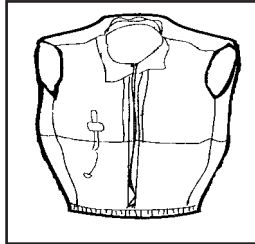

- **TYPE V-** This is the least bulky of all PFD's. It contains a small amount of inherent buoyancy, and an inflatable chamber. It is rated even to a Type I, II, or III PFD (as noted on the jacket label) when inflated. Hybrid PFD's must be worn to be acceptable equipment.

### Maintaining your PFD's

---

A PFD is only useful if it's well maintained. Always be aware of PFD age since it has a life expectancy like any other piece of equipment.

- √ Do a periodic operation check of all PFD's in shallow water.
- √ Be sure to air dry all PFD's after each use. Store in a dry, easily accessible location.
- √ Check periodically for broken zippers, frayed webbing, water soaked kapok bags, missing straps, and sewing that is undone.
- √ Clean each PFD with mild soap and water only. Again, let dry sufficiently before storing.
- √ Keep PFD's out of grease and oil since they can deteriorate the jacket inner and outer materials.
- √ Check any kapok-bagged jackets by squeezing. If jacket loses air the bag is defective and the PFD should be thrown away.
- √ Grab the cover with the fingers. If the cover material rips, the PFD is rotted and should be thrown away.
- √ If the kapok bag is hard the PFD should be discarded.





# CHAPTER 1

## FIRE EXTINGUISHERS

### General Information

Fire extinguishers are classified by a letter and numeric symbol. The letter references the type of fire the unit is designed to extinguish. For example, type B extinguishers commonly used on boats are designed to put out flammable liquids such as grease, oil and gasoline. The number indicates the general size of the extinguisher and minimum extinguishing agent weight.

FIRE EXTINGUISHER CONTENTS				
CLASS	FOAM IN GALS.	CO2 IN LBS.	DRY CHEM. IN LBS.	HALON IN LBS.
<b>B-I</b>	1.25	4	2	2.5
<b>B-II</b>	2.5	15	10	10

MINIMUM PORTABLE FIRE EXTINGUISHERS REQUIRED		
VESSEL LENGTH	NO FIXED SYSTEM	WITH FIXED SYSTEM
LESS THAN 26' 26' TO LESS THAN 40' 40' TO 65'	1 B-1 2 B-1 OR 1 B-II 3 B-1 OR 1 B-II	0 1 B-1 2 B-1 AND 1 B-1 OR 1 B-II



## Safety On Board

---

U. S. Coast Guard approved fire extinguishers are required on all Regal boats. Besides the minimum Coast Guard requirements always check state and local agencies for additional requirements and equipment.

Coast Guard approved extinguishers are hand-portable, either B-I or B-II classification.

U. S. Coast Guard approved hand-portable and semi-portable extinguishers contain a metal plate that shows the manufacturer's name and extinguisher type, capacity and operating instructions. They have a special marine type mounting bracket which keeps the extinguisher solidly mounted until needed. The extinguisher needs to be mounted in a readily accessible location but one out of being bumped by people while underway. All approved extinguishers need to have an indication gauge.

### USCG- Approved Fire Extinguisher Types & Features



The dry chemical agent is widely used because of its convenience and low cost. The extinguisher canister is filled with a white dry chemical powder along with a pressurized gas. It is a good idea to shake this type periodically because they tend to “pack” on the canister bottom.



The foam type uses a chemical foaming agent plus water and is best when used for fires involving flammable liquids- solvents, gasoline, oil, grease and various paints. It will work on fires involving rubber, plastics, cloth, wood, and paper. It leaves a messy residue. Not for electric fires.



The carbon dioxide unit uses CO<sub>2</sub> gas under high pressure, with a funnel discharge hose usually swivel mounted. This extinguisher leaves no residue and does not cause interior engine harm. To ensure workability, weigh the unit annually. A 10% max. wt. variance is allowed.



## CHAPTER 1

---

Another type of liquefied gas is used today in automatic fire extinguishing systems which is used on select models. The canister gas is colorless and odorless, heavier than air and sinks to the lower bilge to extinguish fires. Since the year 2000 ingredients for fire extinguishers have changed to a more environmental friendly formula. The canister needs to be weighed once a year. Automatic fire extinguishing systems feature a dash mount indicator.

## VISUAL DISTRESS SIGNALS

All vessels used on coastal waters, any of the Great Lakes, territorial seas, and those waters connected directly to them, up to point where a body of water is less than two miles wide, must have Coast Guard approved visual distress signals.

### Pyrotechnic Devices

---

Pyrotechnic visual distress signals must be Coast Guard approved, be ready for service and must be readily accessible. They all display a marking which is the service life, which must not have expired. A minimum of 3 devices are required for day and 3 devices for night. Some devices meet both day and night requirements. Pyrotechnic devices should be stored in a cool, dry location. Most of these devices can be purchased in an highly visible (orange) watertight container. Types of Coast Guard approved pyrotechnic distress signals and associated devices are:

- Pyrotechnic red flares, hand- held or aerial type.
- Pyrotechnic orange smoke, hand-held or floating type.
- Launchers for parachute flares or aerial red meteors.



## *Safety On Board*

---

All in all, each distress signal has certain pros and cons. There is no distress signal that is best under all situations. Pyrotechnics are recognized worldwide as superior distress signals. A downfall is they emit a very hot flame that can cause burns and or ignite flammable materials. Pistol launched and hand-held parachute flares operate consistent with firearms and therefore must be carefully handled. Check with local and state regulations since some of these device are considered firearms and are prohibited.

### **Non-Pyrotechnic Devices**

---

Non-pyrotechnic devices must all be in serviceable condition, readily accessible, and must be certified by the manufacturer to comply with Coast Guard standards. They include:

- Orange distress flag
- Electric distress flag

The distress flag is for day use only. It must be 3 x 3 or larger with a black square and ball on an orange background. It can be spotted when attached to a boat hook, long fishing rod, or paddle with the person waving the flag back and forth overhead.

The electric distress flag is for night use only flashing the international SOS distress signal (... \_ \_ \_ ...).

Under Inland Navigation Rules, a high intensity white light that flashes at regular intervals from 50-70 times per minute is considered a distress signal.

Remember that regulations prohibit the display of visual distress signals on the water under any circumstances except when assistance is required to prevent immediate or potential danger to passengers on a vessel.



# CHAPTER 1

## INTERNATIONAL DISTRESS SIGNALS

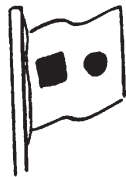

BLACK SQUARE  
AND BALL ON  
ORANGE  
BACKGROUND



CODE FLAGS  
NOVEMBER AND  
CHARLIE



SQUARE  
FLAG AND  
BALL



PERSON  
WAVING  
ARMS



MORSE  
CODE  
S.O.S.



"MAYDAY"  
BY  
RADIO

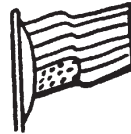

ENSIGN  
UPSIDE  
DOWN



PARACHUTE  
RED  
FLAG



RED METEOR  
FLARES



SMOKE



FOG HORN  
SOUNDED  
CONTINUOUSLY



GUN FIRED  
AT 1-MINUTE  
INTERVALS

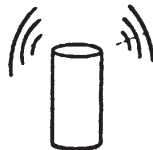

POSITION  
INDICATING  
RADIO BEACON



DYE MARKER  
(ANY COLOR)



HAND-HELD  
FLARE



## Safety On Board

---

### SOUND PRODUCING DEVICES

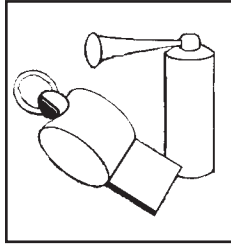

According to both Inland and International Rules, all boats **must** carry some way of producing an efficient sound signal. If your vessel is 12 meters (39' 4") or longer, a power whistle, power horn or bell must be carried. The bell must be 7 7/8" in diameter.

Boats less than 12 meters a horn or whistle is **recommended** to signal intentions or signal position. The sound signal made in all cases must be capable of a four or six second blast audible for one half mile. See the section discussing bridge and whistle signals for more information.

### RADIO COMMUNICATIONS

VHF radios are used for distress and ship to shore and ship to ship communications today. Learn the specialized messages such as **Mayday, Mayday, Mayday** is only used when life or vessel is in imminent danger.

### NAVIGATION LIGHTS

The U. S. Coast Guard requires recreational boats operating at night to display navigation lights between sunset and sunrise. Navigation lights help avoid collisions by improving the night visibility of vessels. Red and green directional lights, white stern lights, white masthead lights and white all-around lights must be displayed in specified positions, depending on boat size, and mode of operation. The configuration of visible lights tells an operator the size, direction of travel and means of propulsion (sail, power, rowing or at anchor) of another vessel. Larger boats are required to carry larger, brighter lights that are visible over longer distances.



# CHAPTER 1

## NAVIGATION LIGHT RULES

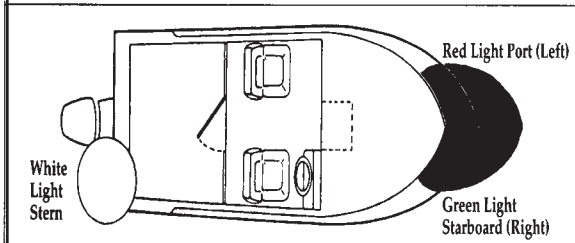

Location of lights on vessel	Visible Range		Degrees of arc lights
	Less than 12 m.	12 m. but less than 20 m.	
Masthead	2	3	225°
All-round	2	2	360°
Side lights	1	2	112.5° each color
Stern light	2	2	135°

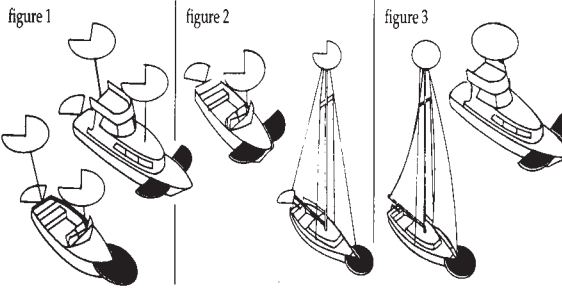

**Boats less than 12 meters in length**  
*Motorboats or sailboats using power:* The lighting arrangements to figure 1, 2 or 3 may be used.  
*Sailboat using sails alone:* The lighting arrangements in figure 4, 5 or 6 may be used.

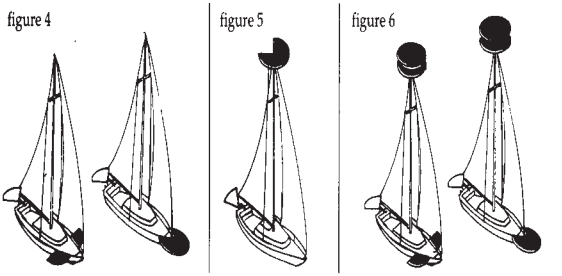

**Boats 12 meters but less than 20 meters in length**  
*Motorboats or sailboats using power:* The lighting arrangements to figure 1 or 2 may be used.  
*Sailboat using sails alone:* The lighting arrangements in figure 4, 5 or 6 may be used.

**Location of lights**  
 Lights should be located as shown in the drawings.  
 The masthead light (forward white light in figures 1, 2 and 7d) must be at least one meter higher than the colored lights on a boat less than 12 meters in length and at least 2.5 meters above the gunwale on a boat 12 meters but less than 20 meters in length.

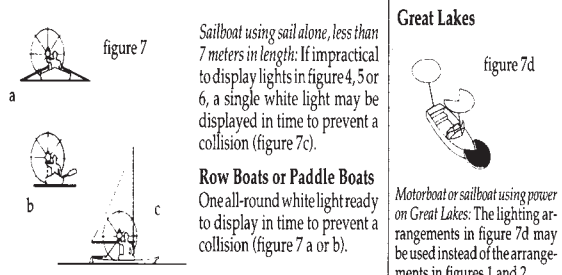

**figure 7**  
*Sailboat using sail alone, less than 7 meters in length:* If impractical to display lights in figure 4, 5 or 6, a single white light may be displayed in time to prevent a collision (figure 7c).  
**Row Boats or Paddle Boats**  
 One all-round white light ready to display in time to prevent a collision (figure 7 a or b).

**Great Lakes**  
**figure 7d**  
*Motorboat or sailboat using power on Great Lakes:* The lighting arrangements in figure 7d may be used instead of the arrangements in figures 1 and 2.

**Exceptions**  
*Motorboat or sailboat using power, built before December 24, 1980:* The lighting arrangement in figure 1, 2 or 3 may be used. However, the arrangement in figure 3 is not acceptable on a boat that is 12 meters or longer on international waters.



### MARINE SANITATION DEVICES

Recreational vessels under 65' with installed toilet facilities must have an operable marine sanitation device (MSD) on board. Vessels 65' and under may use Type I, II, or III MSD. All installed MSD's must be U.S. Coast Guard certified. The sanitation devices as used are labeled to show conformity to the regulations.

### POLLUTION REGULATIONS

The Federal Water Pollution Control Act prohibits the discharge of oil or hazardous substances which may be harmful into U. S. navigable waters. *Vessels 26' and over* must display a placard at least 5" x 8", made of durable material, fixed in a conspicuous machinery space location. You must immediately notify the U. S. Coast Guard if your vessel discharges oil or hazardous substances in the water. Call toll free 800-424-8802. Report the following information: location, source, size, color, substances and time observed.

#### NOTICE

##### DISCHARGE OF OIL PROHIBITED

THE FEDERAL WATER POLLUTION CONTROL ACT PROHIBITS THE DISCHARGE OF OIL OR OILY WASTE INTO OR UPON THE NAVIGABLE WATERS OF THE UNITED STATES, OR THE WATERS OF THE CONTIGUOUS ZONE, OR WHICH MAY AFFECT NATURAL RESOURCES BELONGING TO, APPERTAINING TO, OR UNDER THE EXCLUSIVE MANAGEMENT AUTHORITY OF THE UNITED STATES, IF SUCH DISCHARGE CAUSES A FILM OR DISCOLORATION OF THE SURFACE OF THE WATER OR CAUSES A SLUDGE OR EMULSION BENEATH THE SURFACE OF THE WATER. VIOLATORS ARE SUBJECT TO SUBSTANTIAL CIVIL PENALTIES AND/OR CRIMINAL SANCTIONS INCLUDING FINES AND IMPRISONMENT.



# CHAPTER 1

## Garbage/Placard



The Act to Prevent Pollution from Ships places limitations on the discharge of garbage from vessels 26' and longer. It is illegal to dump plastic trash anywhere in the ocean or navigable waters of the United

States. Also, it is illegal to discharge garbage in the navigable waters of the United States, including the Great Lakes. The discharge of other types of garbage is allowed outside certain specified distances from shore as determined by the nature of that garbage.

A placard is normally found in the cockpit close to the trash receptacle. The typical placard as illustrated below describes the garbage type and nautical mile references as found in the act.

THE DISCHARGE OF PLASTIC OR GARBAGE WITH PLASTIC INTO ANY WATERS IS PROHIBITED. THE DISCHARGE OF ALL GARBAGE IS PROHIBITED IN THE NAVIGABLE WATERS OF THE UNITED STATES AND IN ALL OTHER WATERS, WITHIN THREE NAUTICAL MILES OF THE NEAREST LAND.		
THE DISCHARGE OF DUNNAGE, LINING, AND PACKING MATERIALS THAT FLOAT IS PROHIBITED WITHIN 25 NAUTICAL MILES FROM THE NEAREST LAND.	OTHER UNGROUND GARBAGE MAY BE DISCHARGED BEYOND 12 NAUTICAL MILES FROM THE NEAREST LAND.	OTHER GARBAGE GROUND TO LESS THAN ONE INCH MAY BE DISCHARGED BEYOND THREE NAUTICAL MILES FROM THE NEAREST LAND.
A PERSON WHO VIOLATES THE ABOVE REQUIREMENTS IS LIABLE FOR A CIVIL PENALTY OF UP TO \$25,000, A FINE OF UP TO \$50,000, AND IMPRISONMENT FOR UP TO FIVE YEARS FOR EACH VIOLATION. REGIONAL, STATE, AND LOCAL RESTRICTIONS ON GARBAGE DISCHARGES MAY ALSO APPLY.		



# Safety On Board

USCG Minimum Equipment Requirements for Recreational Vessels			
Boat Size in Feet	16'	26'	40'
Personal Flotation Devices <sup>1</sup>	One Type I, II, III, or V per person		65'
Fire Extinguishers <sup>2</sup>	One Type I, II, III, or V per person plus one Type IV throwable		165'
No Fixed System	One B-I, any type	One B-II or Two B-I	One or more B-II (vessels 0-50 tons gross) Two or more B-II (vessels 50-100 tons gross)
With Fixed System	No Portables Required	One B-I	Two B-I or one Class B-II
Visual Distress	Night signals required when operating at night	Minimum of three day-use and three night-use (or three day/night combination) pyrotechnic devices <sup>5</sup>	
Signals	Horn or whistle recommended to signal intentions or signal position		One bell, and one whistle or horn required to signal intentions or position
Sound Producing Devices	One CG-approved device on each carburetor of all gasoline-powered engines built after April 1940, except outboard motors		
Backfire Flame Arrestor	One CG-approved device on each carburetor of all gasoline-powered engines built after April 1940, except outboard motors		
Ventilation	CG standard system required on gasoline powered vessels with enclosed engine compartments built after August 1980		
Navigation Lights	Sidelights, Stern Light and Masthead <sup>6,7</sup>		
Under Power <sup>3,4</sup>	Same as "Under Sail"		
Rowing	All-round light, 2mm (at night) or black anchoring ball (during the day) when outside a designated anchorage		
At Anchor	1mm Sidelights, 2mm all others		3mm Masthead, 2mm all others
Visibility Range	"Honor system" (no plaques required)		5" x 8" Oil Discharge placard and 4" x 9" Waste Discharge placard
Pollution	Vessels with installed toilet facilities must have an operable, CG-certified Type I, II or III Marine Sanitation Device (MSD). Subject to local laws!		Vessels over 40' with a galley must have a Waste Management Plan
Regulations	Familiarity with the Inland Navigation Rules required		Type II or III MSD only
Marine Sanitation Devices			
Navigation Rules			The Inland Navigation Rules ("Rules of the Road") must be kept on board

1. PFD's must be CG approved, wearable by the intended user and readily accessible.
2. Fire extinguishers required on boats with enclosed engine compartments (not outboards), enclosed living spaces or permanent fuel tanks.
3. Sailboats operating under engine power are considered power driven and must follow the "Under Power" rules. During the day, motorsailing vessels are required to fly a motoring cone.
4. Power-driven vessels under 23' and under 7 knots can substitute a white lantern or torch in place of the required lights.
5. Non-pyrotechnic substitutes: 1 orange distress flag (day-use) and 1 electric SOS signal light (night-use).
6. All boats under 65' can substitute a single bi-color light for sidelights.
7. Boats under power under 40' can substitute a single all-round light for separate stern and masthead lights.
8. Boats under sail under 40' can substitute a tri-color light for separate sidelights and stern light.

**Additions to these requirements are prescribed by some individual state laws. Check your state's Boating Safety Handbook for a complete list.**



## CHAPTER 1

---

### Communications

---

EPIRB

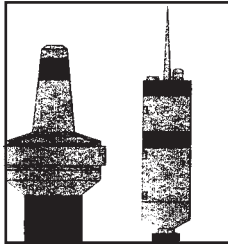

It is a good idea to carry communication gear such as a VHF-FM and/or HF transceivers set up for your operating area. Also, cell phones are useful in many coastal areas. Be sure to carry extra batteries. Also, mainly for offshore vessels, EPIRB's are designed to quickly and accurately alert rescue forces, indicate an accurate distress position, and guide units to the distress scene. These devices operate from satellite signals sent to a ground station where the signal is downloaded. The downside is that they are relatively expensive but they are reliable even when other communications have been exhausted.

### Life Rafts

---

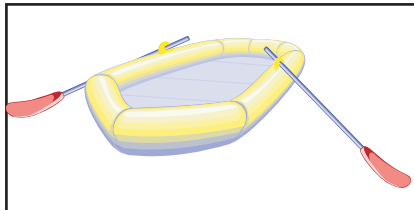

Inflatable life rafts are recommended for oceangoing and operating a vessel in a large body of water like the Great Lakes. They provide a shelter for extended periods. If used, make sure it is large enough for all aboard and contains the proper emergency equipment pack. Periodically find a professional to service the life raft. Store it on board in an area safe from sharp objects. Make sure the life raft is Coast Guard approved.

**Remember the U. S. Coast Guard requirements are minimal standards.** They are an excellent starting point. Check with local and state boating agencies for further required safety equipment. You are best prepared for emergencies by a well equipped vessel. Don't skimp when purchasing equipment for your boat!



### EXHAUST & CARBON MONOXIDE

Carbon monoxide (CO) in exhaust can be hazardous. It is important for you and your passengers to be aware of the potential safety hazard created by exhaust gases. Familiarize yourself with the symptoms of carbon monoxide poisoning.

**For safety sake avoid the following:**

1. Do not allow the boat to remain stationary with the engine idling for an extended period of time.
2. Do not disable the carbon monoxide alarms that come with your Regal boat. Test the unit in accordance with the alarm manufacturers instructions.
3. Do not operate the engine for extended periods of time while in a confined area or where exhaust outlets face a wall or bulkhead.
4. Do not operate the engine for an extended period of time with the canvas in the upright and installed position.
5. Have the engine exhaust system inspected when the boat is in for service.
6. Persons sleeping can easily be overcome by carbon monoxide without realizing it. Do not sleep on board while the engine is running or a neighboring boats engine is running.

	<b>WARNING</b>
AVOID SERIOUS INJURY OR DEATH FROM CO POISONING! DO NOT OPERATE THE BOAT WITH PEOPLE HOLDING ON TO THE SWIM PLATFORM WHILE IN THE WATER.	



# CHAPTER 1

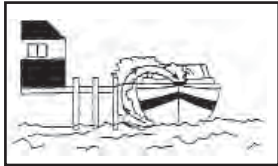

Blockage of exhaust outlets can cause carbon monoxide to accumulate in the cabin and cockpit area even when the hatches, windows, portholes and doors are open.



Exhaust from another vessel alongside your boat, while docked or anchored, can emit poisonous CO gas inside the cabin and cockpit areas of your boat.

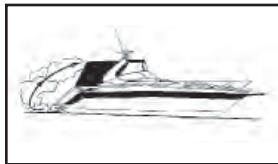

The “station wagon effect” or back drafting can cause CO gas to accumulate inside the cabin, cockpit or bridge areas when the boat is under-way, using protective weather coverings, high bow angle, improper or heavy loading, slow speeds, or when boat is at rest.

## Typical Carbon Monoxide Label At Helm

<b>⚠ WARNING</b>	
	<p><b>Carbon monoxide (CO)</b> can cause brain damage or death.</p> <p>Engine and generator exhaust contains odorless and colorless carbon monoxide gas.</p> <p>Signs of carbon monoxide poisoning include nausea, headache, dizziness, drowsiness, and lack of consciousness.</p> <p>Get fresh air if anyone shows signs of carbon monoxide poisoning.</p> <p>See Owner's Manual for information regarding carbon monoxide poisoning.</p>

## Typical Carbon Monoxide Label At Transom

<b>⚠ DANGER</b>	
	<p><b>Carbon monoxide (CO)</b> can cause brain damage or death.</p> <p>Engine and generator exhaust contains odorless and colorless carbon monoxide gas.</p> <p>Carbon monoxide will be around the back of the boat when engines or generators are running.</p> <p>Move to fresh air, if you feel nausea, headache, dizziness, or drowsiness.</p> <p style="text-align: right; font-size: small;">NW-208-05</p>



## Safety On Board

### Typical Carbon Monoxide Label In Cabin/Head

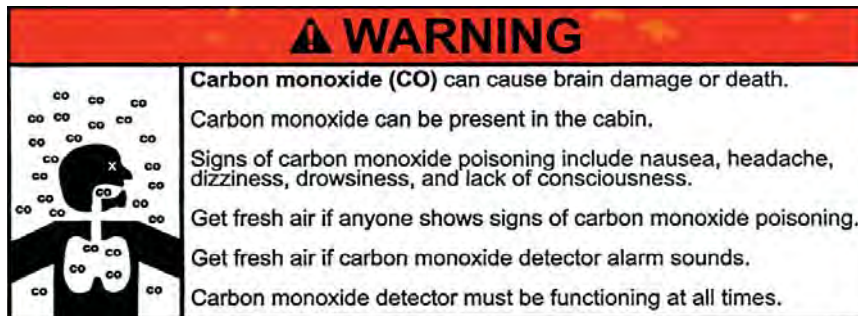

In high concentrations, CO can be fatal in minutes. However, lower concentrations over an extended period of time can be just as lethal.

Symptoms of excessive exposure to carbon monoxide are:

- Dizziness
- Drowsiness
- Nausea
- Headache
- Ringing in the ears
- Throbbing temples
- Watery, itchy eyes
- Flushed appearance
- Inattentiveness
- Incoherence
- Fatigue or vomiting
- Convulsions

Carbon monoxide accumulation requires immediate attention! Thoroughly ventilate cabin and cockpit areas. Determine the probable source of the carbon monoxide and correct the condition immediately. Regal has installed CO detectors on your boat. Have these detectors professionally calibrated at regular intervals.



DESIRED AIR FLOW  
THROUGH BOAT

To help prevent carbon monoxide accumulation, ventilate your cabin and cockpit while underway. Open a forward hatch, porthole or window to allow air to travel through the boat's interior. See the illustration below for desired air flow.



## CHAPTER 1

---

### Each Trip

---

- Make sure all exhaust clamps are in place and secure.
- Look for exhaust leaking from the exhaust system components, indicated by rust and or black streaking, water leaks, or corroded or cracked fittings.
- Inspect all rubber exhaust hoses for burned or cracked areas. All rubber hoses should feel soft and be free of kinks.
- Visually verify that water exits at the engine exhaust outlet.
- Keep an ear tuned for any change in exhaust sound that could indicate an exhaust component malfunction.

**DO NOT OPERATE THE VESSEL IF ANY OF THE ABOVE ITEMS EXIST;  
CONTACT A MARINE PROFESSIONAL!**

### **At Least Annually** (To be performed by a marine professional)

- Replace exhaust hoses or mufflers if any evidence of cracking, charring or deterioration is found.
- Replace the engine water pump impeller along with the plate and housing if necessary. This will help prevent cooling system and in turn exhaust system overheating.
- Inspect each of the metallic exhaust components for cracking, rusting, leaking or looseness. Pay detailed attention to the exhaust manifold, cylinder head and water injection elbows. Make sure all exhaust clamps are in place and secure.



### BOATING UNDER THE INFLUENCE



#### **WARNING**

FEDERAL LAWS PROHIBIT OPERATING A VESSEL UNDER THE INFLUENCE OF ALCOHOL OR DRUGS. THESE LAWS ARE VIGOROUSLY ENFORCED BY ALL ENFORCEMENT AGENCIES.

Operating a vessel while intoxicated became a specific federal offense effective in 1988. The ruling set federal standards for determining when an individual is intoxicated. If the blood alcohol content (BAC) is .10% (.08 in some states) or higher for operators of recreational vessels being used only for pleasure are subject to a civil penalty up to \$1,000 or criminal penalty up to \$5,000, one year imprisonment or both. In some states the fines and imprisonment may increase significantly.

The effects of alcohol and drugs account for the highest single cause of marine accidents and deaths. Most deaths in boating accidents occur when someone falls into the water. Balance is one of the first things you lose when drinking alcohol or under the influence of drugs. The problem arises out of not knowing your balance is restricted.

Overall vision is reduced by alcohol especially at night, along with double or blurred vision. Peripheral vision is lessened which restricts seeing vessels or objects on the side. Also, color awareness decreases especially with red and green which happen to be the colors of boat navigation lights, buoys, and channel markers.

Alcohol will greatly increase your heat loss so it increases the effects of hypothermia. Finally, your ability to make correct judgements in emergency situations is greatly reduced. Alcohol takes away the brains ability to process information quickly and delays a persons reaction time. **Don't drink and drive!**





# CHAPTER 1

## Alcohol Myths And Facts

**Myth:** Beer is less intoxicating than other alcoholic beverages.

**Fact:** One 12 oz. can of beer has about the same amount of alcohol as a 5oz. glass of wine or a shot of liquor.

**Myth:** Black coffee, fresh air, and a shower will sober the effects of alcohol.

**Fact:** After consuming alcohol time is the only thing that will sober you up. Our bodies average burning 1 oz. of alcohol every hour. If a person is drunk, it will take about seven or more hours to sober up.

**Myth:** Telling if a person is too drunk to operate a vessel is easy.

**Fact:** Many experienced drinkers have learned to compensate for the visual effects of alcohol and can disguise their drunk condition.

**Myth:** You're the best person to judge if you are fit to operate a boat.

**Fact:** Judgement is one of the first elements you lose when drinking.

BLOOD ALCOHOL CONTENT CHART									
Body Weight In Pounds	Number of Drinks In A 2 Hour Period (12 oz. beer=5 oz. wine=1 oz. 80 proof liquor)								
100	1	2	3	4	5	6	7	8	9
120	1	2	3	4	5	6	7	8	9
140	1	2	3	4	5	6	7	8	9
160	1	2	3	4	5	6	7	8	9
180	1	2	3	4	5	6	7	8	9
200	1	2	3	4	5	6	7	8	9
220	1	2	3	4	5	6	7	8	9
240	1	2	3	4	5	6	7	8	9
BAC to .05%	- - - Be Careful- Loss of Judgement & Coordination								
BAC .05% to .10%	==== Abilities Impaired- Accident Chance Increased								
BAX. Over 10%	===== Do Not Operate A Boat- High Accident Risk								



## Safety On Board

---

### BOATING ACCIDENTS



The following is a list of common causes of boating accidents. Be aware of them and take the necessary steps to ensure that your crew and yourself are educated and prepared to act in an emergency.

- Mixing boating and alcohol. Remember the skipper is responsible for his boat and crew.
- Trying to reach the bow by the deck walk-around while the boat is moving too fast.
- Someone sitting on the bow, deck, or swim platform while underway.
- Choosing a boating outing day with inclement weather, especially with high winds and thunderstorms in the forecast or staying out when bad weather is approaching.
- Disembarking without checking all fluids or systems, especially fuel system components.
- Not monitoring the boating traffic or possible obstructions around you.
- Emergency communications equipment, signaling devices, and navigation lights not working.
- Improper boat handling especially high speed turns in rough water. Improper trim.
- Being too far from shore with inadequate fuel supply or navigational aids.



## CHAPTER 1

---

- Passengers, especially children that are not wearing the proper life saving devices.
- Skipper or passengers not seated in the boat.
- Running a craft that is mechanically marginal.

### Reporting Boating Accidents

---

According to the Federal Boat Safety Act of 1971 involving collision, accident or other casualty, the operator must make a formal report within 48 hours to the nearest state boating authority when the incident involves:

1. Death
2. Injury requiring treatment other than first aid
3. The disappearance of someone from a boat under death or injury circumstances.
4. Damage to vessels and other property totals \$2000 (lower amounts in some states and territories) or more.
5. The boat is destroyed.

A formal report must be made within 10 days for accidents involving more than \$500 damage or complete loss of vessel.

For information regarding accident reporting, please call:

**Boating Safety Hotline** at 800-368-5647.

### Rendering Assistance

---

The operator of a vessel is obligated by law to provide assistance that can be provided safely to any individuals in dangerous situation on the waterways. The operator is subject to fine and or imprisonment for failure to do so. Move cautiously and think before acting.



## Safety On Board

---

### WATER SPORTS

Besides learning the safety precautions for safe boating, as well as understanding and knowing required rules and regulations, you are obligated to be particularly careful around other water sportsman, such as scuba divers, water skiers, wake boarders, and fisherman.

#### Skin & Scuba Divers

---

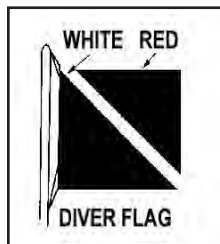

Whenever you see a “Diver Down” flag, maintain a distance of at least 100 feet on inland waters. In bays and open waters stay 300 feet away. The flag indicates a diver in the water. If a diver is operating from your boat, be certain to use this flag and post a lookout on board for a divers air bubbles. Sometimes divers stray from the flag area.

#### Water Skiers & Wakeboarders

---



For information on water skiing and how to get started, we recommend you contact the American Water Ski Association, P. O. Box 191, Winter Haven, Florida 33880. They offer pamphlets and instructional materials.

For wake boarding information there are numerous training schools throughout the country along with instructional videos and the internet.



## CHAPTER 1

---

General safety procedures for towing skiers and wake boarders include the following:

- Know your hand signals and make sure all your passengers know them. See the illustration.
- Do not allow non-swimmers to ski or wake board. You're asking for trouble!
- Always have an observer on board whose sole job is to watch the skier/wakeboarder and communicate with the driver.
- If you plan to do plenty of skiing/wake boarding, it is advisable to have a ski pylon and driver's rear view mirror installed as needed.
- Acquaint yourself with the ski site before skiing/wake boarding.
- Follow the speed limits and all posted signs- i.e. no wake, etc.
- Keep the boat away from swimmers or other people in the water.
- Avoid running near the shoreline or in heavily congested areas with skier/wake boarder in tow.
- Do not allow skier/wake boarder to spray fisherman or other parties.
- Keep the engine speed steady while towing a skier/wake boarder.
- Make wide turns with skier/wake boarder in tow.
- Instruct skier/wake boarder in case of a fall to raise his ski in the air to ensure his visibility.
- Always turn your engine off when the skier/wake boarder is near the platform or transom.



## Safety On Board

---

□ If the skier falls, return promptly to retrieve him, circling wide from the starboard side, to bring his rope within easy grasp.

	<b>WARNING</b>
<p>AVOID SERIOUS INJURY OR DEATH! DO NOT USE SKI TOW FITTING FOR LIFTING OR PARASAILING. THE FITTING COULD PULL OUT OF DECK.</p>	

### Swim Platform/Typical Label

---

<p><b>WARNING!</b> <b>MAXIMUM CAPACITY</b> <b>OF SWIM PLATFORM</b> <b>500 POUNDS</b> <b>226 KG</b></p>
--

On integrated or extended swim platforms you should make periodic inspections of the swim ladder and swim platform hardware to ensure that all connectors and fittings are tight and free from corrosion. Never run the boat with someone holding on to or standing/sitting on the platform. Use heed when operating the boat in reverse to insure that water does not accumulate excessively on the platform especially in rough seas or strong currents. Do not exceed the platform recommended maximum capacity **label!**



# CHAPTER 1

## WATER SKI & WAKEBOARD SIGNALS



FASTER



SLOWER



SKIER OK  
AFTER FALL



CAUTION OR FALLEN  
SKIER; PICK ME UP

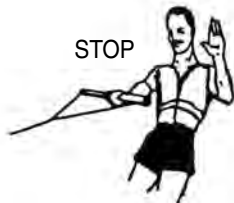

STOP



SHUT ENGINE  
OFF



RETURN TO DROP  
OFF AREA



SPEED OK

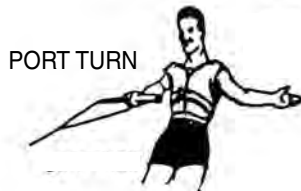

PORT TURN

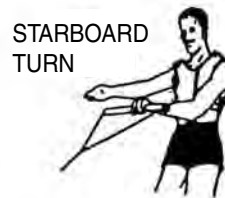

STARBOARD  
TURN



## Safety On Board

---



### WARNING

AVOID SERIOUS INJURY OR DEATH!  
DO NOT OPERATE THE BOAT  
WITH PEOPLE IN THE WATER  
OR ON TOP OR HOLDING ON TO  
THE SWIM PLATFORM STRUCTURE OR HARDWARE.

### Fishing

---

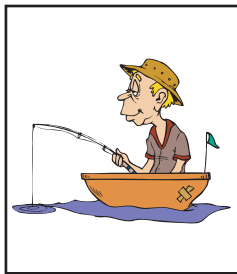

Most boaters fish from time to time. With today's propulsion systems it is possible to fish in out-of-the-way places. When cruising, stay clear of fisherman. They may have lines or nets out which might be cut or get caught in your propeller if you come too close. Slow down when approaching fishing boats.

Do not return to cruising speed until the boats have been passed. If a fishing boat should be anchored, a large wake could flip or swamp the boat, upset fishing gear, pull the anchor loose from the bottom or worse yet cause someone to fall overboard.

When fishing from your boat, never anchor in the shipping channel or tie up to any navigational aids. These must be kept clear of at all times. Be sure to carry a chart of the area and be on the lookout for shallow water and hidden obstructions. Pick up a local tidal chart if appropriate so you do not end up grounded.

**Remember, the skipper is responsible for any damage caused by his wake. Use common sense and be a responsible captain!**





## CHAPTER 1

# WEATHER & WATER CONDITIONS

Before a boating outing check the weather conditions. As we all know the weather can change rapidly in many parts of the country. It does so sometimes without being predicted. NOAA weather radio reports are continuously available on designated frequencies installed on VHF radios and various handheld devices. Also, many local radio stations carry weather reports.

### Cloud Formations

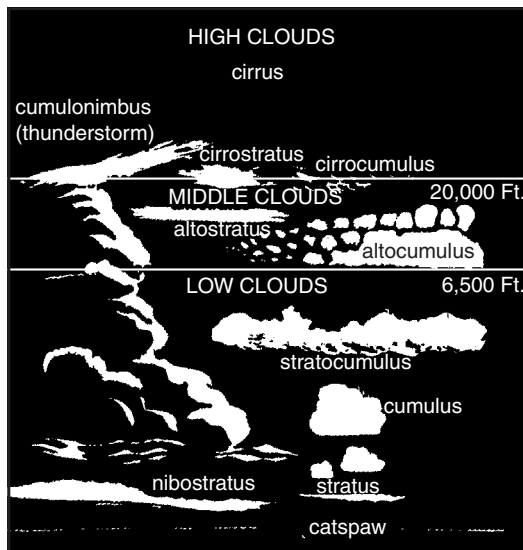

Clouds indicate the type of current weather and upcoming changes in the weather. Knowing the type of cloud formations can assist you in choosing the appropriate boating day or if already on the water will help you understand any upcoming weather changes.

Flat clouds (stratus) normally indicate stable air. Cumulus clouds indicate unstable air.

Many times a “cotton ball” or cumulus cloud builds vertical height in the afternoon and the result is a thunderstorm with increased winds and waves; sometimes these storms are quite violent. You can find additional information on weather (meteorology) at your local library. In addition, water spouts can develop with the right conditions. If one exists close by try to determine which direction it is heading and exit in the opposite direction to a safe haven preferably shore.



## Safety On Board

---

### Waves & Fog

---



As the wind blows across water waves are created. The stronger the wind and increased distance across the water enlarges the wave action.

Other factors that can cause problem situations for vessels are fog, currents, and tidal changes.

Fog can develop inland on clear, calm mornings. Coastal areas see large “blankets” of fog roll in and stay for extended time periods causing sometimes hazardous navigation conditions. If you are caught

in the fog, do not panic. Think of the best plan of action and proceed carefully. If you are limited in navigation equipment at the first sign of fog proceed to the nearest shoreline and wait until the fog lifts.

Boats equipped with navigation equipment, local waterway experience and charts should proceed to a safe harbor. Use extreme caution, signal as needed, and reduce to a speed where you can stop within half of your forward vision range.







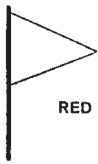

#### **If foul weather catches you at sea do the following:**

1. Slow down. Proceed with caution and put on your life vests.
2. Try to reach the nearest safe shoreline.
3. Navigate your vessel slowly into the waves at a 45 degree angle.
4. Passengers should sit low in the center of the vessel.
5. Monitor your bilge pump. Make sure sump stays free of water.
6. Secure loose gear. Make ready emergency equipment.
7. If the engine stops, throw the anchor over the bow. If needed use a sea anchor. Never anchor off the stern.

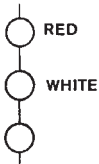

# CHAPTER 1

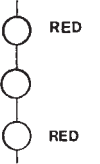
## Marine Weather Symbols

	SMALL CRAFT	GALE	STORM	HURRICANE
DAY FLAGS	 RED	 RED	 RED & BLACK	 RED & BLACK
NIGHT LIGHTS	 RED WHITE RED	 WHITE WHITE RED	 RED WHITE RED	 RED WHITE RED

Although the National Weather Service has discontinued the use of the day flags and night lights, many marinas and ports of call still display them.



# Rules Of The Road

## NAVIGATION RULES DEFINED



The Navigation Rules set forth actions to be followed by boats to avoid collision. They are referred to as the “Rules of the Road”. There are two main parts referred to as the inland and international rules. The inland rules apply to vessels operating inside the

boundaries of the United States. The international rules referred to as 72 COLREGS apply to vessels operating on the high seas and all connected waters outside the established demarcation boundaries. Most navigational charts show the demarcation lines by red dotted lines and are published in the navigation rules. Remember to consult state and local agencies since areas such as “no wake zones”, swimming beaches, “diver down flag” and inland landlocked lakes fall under their jurisdiction.

This section is only an introduction to the “rules of the road”. We strongly recommend additional training before running your boat.



### **WARNING**

**TO AVOID INJURY AND DEATH!  
FOLLOW THE NAVIGATION “RULES OF THE ROAD”  
TO PREVENT COLLISIONS.**

You can order the Inland & International Navigation Rules from:  
Superintendent of Documents  
U. S. Government Printing Office  
Washington, DC 20402  
Telephone: (202-512-1800) Fax:(202-512-2250



## CHAPTER 2

---

### NAVIGATION RULES

#### Right Of Way

---

1. Cross waves at right angles.
2. When caught in heavy water or squalls, head either directly into the waves or at a slight angle. Reduce speed, but maintain enough power to maneuver your boat safely.
3. Keep your speed under control. Respect the rights of other boaters engaged in all water sports. Give them a “wide berth”.
4. Whenever meeting a boat head on, keep to the right where possible.
5. When two boats cross, the boat to the right (starboard) has the right of way.
6. When overtaking or passing, the boat being passed has the right of way.

In general, boats with less maneuverability have right-of-way over more agile craft. The skipper must keep his craft clear of the following vessels:

- A vessel not under command or aground; due to their circumstances, these vessels have no maneuverability.
- A vessel restricted in its maneuverability; these vessels usually are performing work which limits their maneuverability such as surveying, dredging, laying pipe or cable, or servicing navigational markers among others.
- A vessel engaged in fishing; these include boats fishing with lines, trawls or nets, but not trolling lines.



# Rules Of The Road

- Sailboats; they have the right-of-way over power boats. However, if a sailboat is using a prop to move forward, it is considered a powerboat even if the sails are up.
- Remember the unwritten “rule of tonnage”. Basically a smaller tonnage vessel should take every effort to avoid close quarters with a larger tonnage vessel. One way to accomplish this is to have a designated human lookout to “eyeball” the horizon for any developing collision course.
- Use defensive driving skills on the waterway just as you do on the roadway. The other vessel may not know the “rules of the road” Be alert and ready to take immediate action.
- If a collision course is unavoidable neither boat has the right of way. Both boats must react to avoid an accident according to the rules of the road.

## Signals





## CHAPTER 2

### NAVIGATION RULES

The Navigation Rules set forth 3 types of crossing situations- crossing, meeting, and overtaking. In each case, both boats are governed by special procedures.

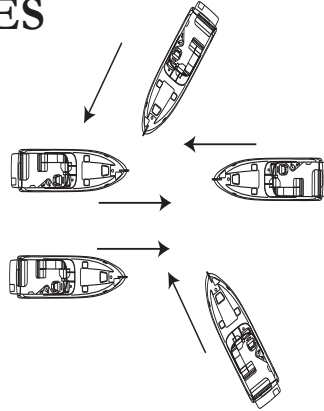

In a head-on meeting, both vessels must sound a single blast to give way toward starboard and pass to port.

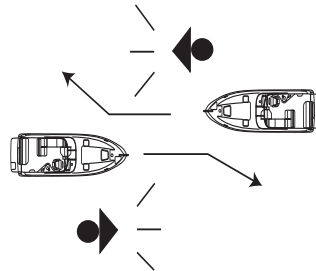

These rules appear when there is a risk of collision. In a crossing situation be aware of the other craft's position. For safety, there should be a noticeable change in the angle, bow or stern; a gradual change in position indicates possible danger.

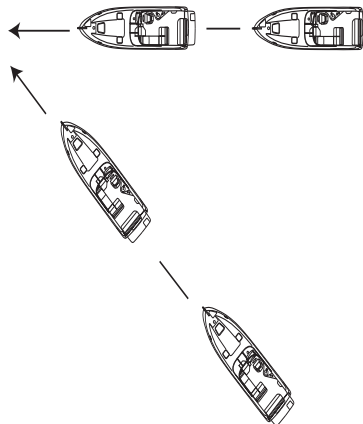



# Rules Of The Road

## NAVIGATION RULES

An overtaking boat is burdened, and is not the privileged craft, even though it approaches the danger zone of the overtaken boat.

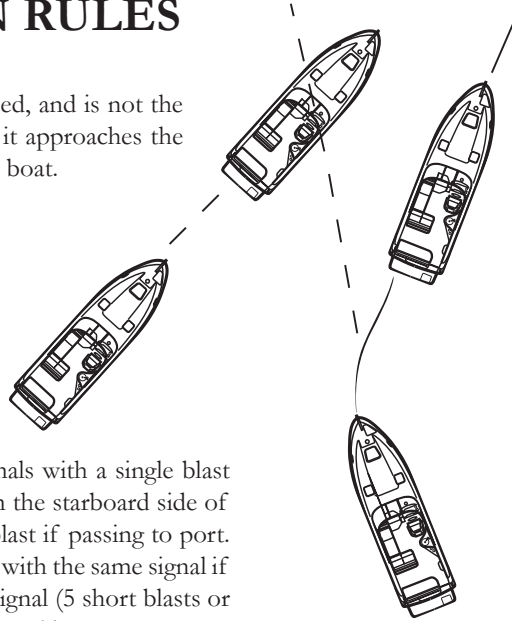

The overtaking boat first signals with a single blast if that boat desires to pass on the starboard side of the boat ahead, or a double blast if passing to port. The overtaken craft responds with the same signal if it is safe, or with the danger signal (5 short blasts or more) if unsafe. The boat overtaking must not pass unless the appropriate signals are sounded.

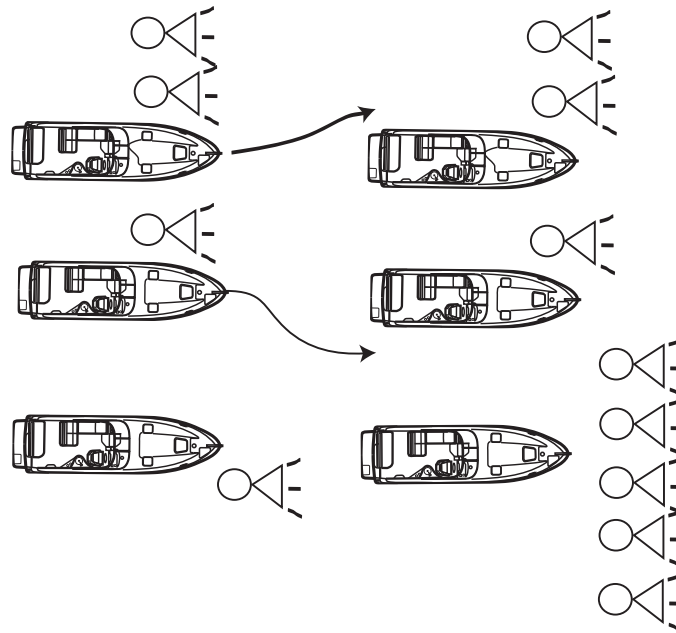





## CHAPTER 2

---

### NAVIGATION AIDS

Navigation aids are placed along coasts and navigable waters as a guide for mariners in determining their position in reference to land and hidden danger. Each aid provides specific information. They form a continuous system of charted markers for accurate piloting on paper and on the water.

Nautical charts are provided by the National Ocean Service (NOS) and are distributed nationwide through marinas and outlet stores. These charts show the geography of the coast, water depth, landmarks, navigation aids (buoys and markers), marine hazards, and port facilities. Use only up-to-date charts for navigation. We recommend when purchasing a chart to look for the weather resistant ones.

Buoys provide a road map to keep the skipper on course and to avoid hazards. Buoys are identified by light, shape, color and in severe weather conditions by sound.

Buoys or beacons called lateral markers indicate the port and starboard sides of the waterway to be followed. U. S markers follow the buoy system known as Red Right Returning. When returning from sea or traveling upstream, the green markers are to port (on your left) and the red markers are to the starboard side (on your right). When traveling downstream or out to sea the marker color would be reversed. The Intercoastal waterway uses a different system of lateral markers for port and starboard. Before operating your vessel, learn to identify the various navigational aids such as lateral aids, mid-channel markers, information and regulatory markers.

### **NOTICE**

**SKIPPERS MUST NOT RELY ON BUOYS ALONE  
TO MARK THEIR POSITION.  
SEVERE WEATHER CONDITIONS  
AND WAVE ACTION CAN ALTER A BUOYS POSITION.  
NEVER TIE UP TO A BUOY.  
IT IS ILLEGAL AND EXTREMELY DANGEROUS.**



# Rules Of The Road

## LATERAL AIDS

Port Side  
Odd Numbers

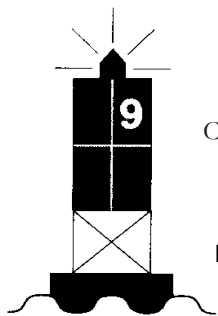

Chart Symbol



G "9"  
Fl G 4 sec

Lighted Buoy  
(Green Light Only)

Starboard Side  
Even Numbers

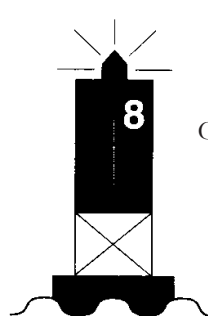

Chart Symbol



R "8"  
Fl R 4 sec

Lighted Buoy  
(Red Light Only)

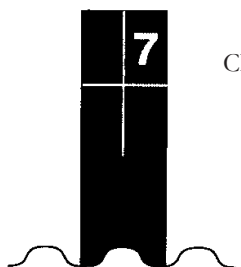

Chart Symbol



C "7"

Can Buoy  
(Unlighted)

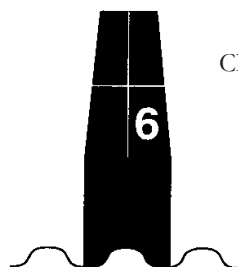

Chart Symbol



N "6"

Nun Buoy  
(Unlighted)



Chart Symbol



G "1"

Daymark



Chart Symbol



R "2"

Daymark



# CHAPTER 2

## MID-CHANNEL MARKERS

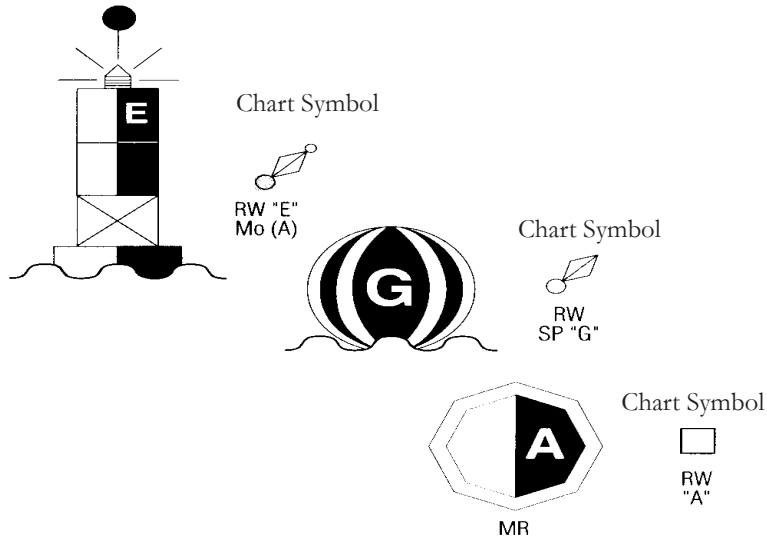

## REGULATORY MARKERS

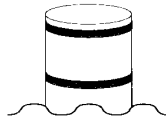

Diamond Shape  
Danger Warning



Diamond Shape With Cross-  
Boats Keep Out



Circle Marks Area Controlled  
As Indicated



For showing information such  
as locations, distances and  
directions



# Rules Of The Road

## NIGHT RUNNING

Boats operating between sunset and sunrise (hours vary by state), or in conditions of reduced visibility, must use navigation lights. Nighttime operation, especially during bad weather and fog, can be dangerous. All Rules of the Road apply at night, but it is best to slow down and stay clear of all boats regardless of who has the right-of-way.

To see more easily at night, avoid bright lights when possible. Also, it is helpful to have a passenger keep watch for other boats, water hazards and navigational aids.

To determine the size, speed and direction of other vessels at night, you should use the running lights. A green light indicates starboard side, and a red light indicates port side. Generally, if you see a green light, you have the right-of-way. If you see a red light, give way to the other vessel.

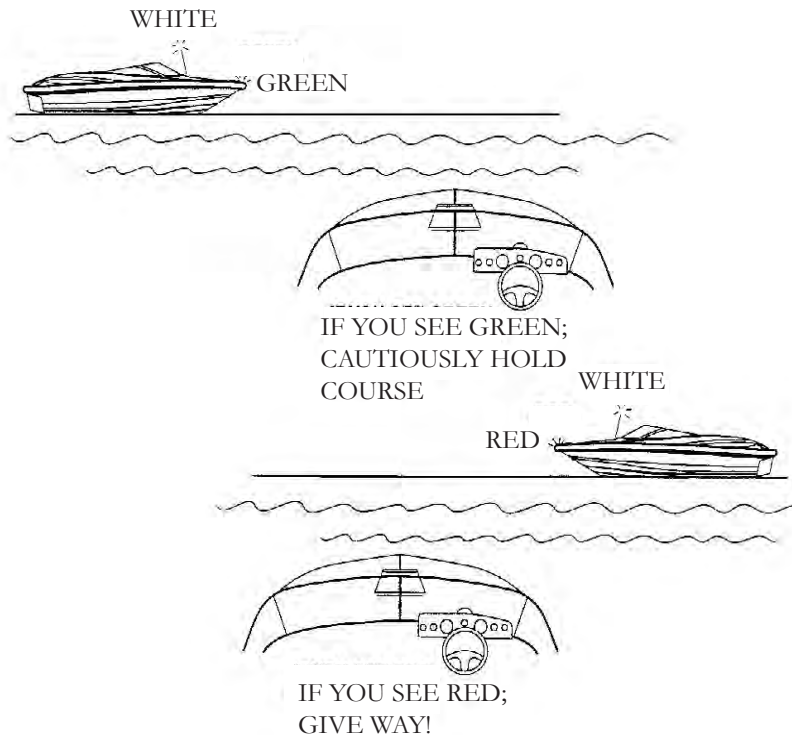



## CHAPTER 2

### BRIDGE CLEARANCE



Be aware that your vessel requires a specified bridge clearance height. This height is a measured estimate from the waterline to the top of the highest object usually the power tower, radar or the

masthead light depending on what tower equipment is installed. All canvas should be in the stored position. The estimated height can change because of variances in the loaded condition of the vessel. Consult the estimated bridge clearance specifications located in Chapter 12 (technical information section). An easy way to measure bridge clearance is to have someone place a long straightedge such as a piece of wood at a 90 degree angle across the highest point of the boat with the boat in the water. Then with a tape rule measure the distance straight down (90 degrees) to the waterline. Take this measurement with the fuel and water tanks 1/2 full and only 1 person besides yourself on board. This will give you a safe measurement. As your boat is loaded down with people the bridge clearance will be slightly lower.

Some bridges are tendered. Know and use the proper bridge signals when approaching these bridges (see bridge signals on page 2-3). You can also monitor and communicate on channel 13 of a VHF radio for bridge information in most domestic locals. Other bridges are marked with a clearance measurement and you are on your own. After determining your vessel will clear the bridge proceed with caution at a safe idle speed. Keep your eye on vessel traffic at all times in order to react quickly. Resume a safe speed once clear of the bridge structure and acknowledgment of clear visibility.

Use common sense regarding bridge clearance because since injury and property damage could result if a mishap occurs with a bridge structure.



---

# Engines & Controls

## ENGINE

---

### Engine Basics



It is important that you read the engine manual carefully and become familiar with the operation as well as necessary maintenance on the engine and propulsion systems. Pay careful attention to the sections on winterization if you live in freezing climates. Extensive damage can result if proper winter storage is not followed. Your Regal dealer has been factory trained on Regal boat systems. Consult your Regal dealer for further information regarding technical issues and parts.



## WARNING

AVOID SERIOUS INJURY OR DEATH!  
READ ALL MANUFACTURER'S ENGINE AND  
PROPULSION OWNER'S MANUALS  
BEFORE OPERATING YOUR VESSEL.

### Engine Mounts

---

The engine is set in the boat on a group of metal platforms called mounts. These engine-hull attached rubber isolation mounts keep the engine from moving laterally and at right angles to the center-line. The mounts help reduce the vibration caused by the engine and drive. Periodically, the mount hardware should be checked for tightness.



## CHAPTER 3

---

### Engine Alignment

---

The engine uses a rubber spline hub to which the stern drive shaft is attached. This alignment specification between the engine and stern drive needs to be checked periodically. It should be checked after each 50 hours of operation or if the vessel has run aground or hit a submerged object. Alignment should be checked by a Regal dealer or marine professional since special tools and procedures are required.

### Engine Removal

---

In the event the engine or out-drive (sometimes referred to as stern drive) requires major service where it needs to be removed, consult your Regal dealer.

### Engine Ventilation

---

Ventilation systems are required for engine compartments. Your boat features a set of deck vent shrouds with covers that supply fresh air constantly to the engine compartment. A powered blower motor connected to ducts in the lower one third of the bilge evacuates air to the atmosphere. **Read and understand the following warning.**



## WARNING

**GASOLINE VAPORS CAN EXPLODE. BEFORE STARTING ENGINE, OPERATE BLOWER 4 MINUTES AND CHECK ENGINE COMPARTMENT FOR GASOLINE LEAKS OR VAPORS. RUN BLOWER BELOW CRUISING SPEED.**

All owners are responsible for keeping their boat's ventilation systems in operating condition. This means making sure the ventilation covers are obstruction free, ducts are not blocked or torn, blower operates properly and any worn parts are replaced with ignition protected marine parts.



### **Catalyst Engines**

---

Due to federal and state regulations many newer domestic marine engines are retrofitted from the engine manufacturer with a catalytic converter system for a cleaner environment. The sheer numbers of these engines will fill the marine propulsion market over the next few years.

Simply stated, a catalytic converter utilizes extreme heat to reduce the engine's output of hydrocarbons and carbon monoxide thus reducing pollutants. The system theory involved follows the automotive market but the actual parts and closed loop designs are unique to the marine industry due to temperature, space restrictions, weight and corrosion factors found in the marine environment.

Both major engine manufacturers incorporate catalytic converters within a water-jacketed manifold. Oxygen sensors are placed in the system along with on board monitoring equipment. The systems permit the engines to operate at normal horsepower ratings.

Read and understand the typical emission monitoring system explained later in this chapter. Also, read the engine manufacturer's operation manual for more detailed information regarding catalytic converters and system maintenance requirements.





## CHAPTER 3

---



### WARNING

TO PREVENT FIRE OR EXPLOSION  
USE ONLY APPROVED MARINE REPLACEMENT  
PARTS THAT ARE IGNITION PROTECTED.

## PROPULSION

### Stern Drive

---

It is important that you read the engine/stern drive operator's manual carefully and become familiar with the operation as well as necessary maintenance on the drive unit components. Pay careful attention to the sections on winterization if you live in freezing climates. Extensive damage can result if proper winter storage is not followed. Refer to the maintenance section of this manual for more information or call your nearest Regal dealer.

### Propellers

---



We have carefully tested and chosen the propellers to give your stern drive boat the best possible performance and have allowed for the additional weight in equipment that might be added to the boat. It is a good idea to carry a spare set of propellers and hand tools in order to handle an emergency propeller change. Refer to the engine manual for

proper procedures since each stern drive application is unique. Call a marine professional or your Regal dealer for further information.



### **DANGER**

**PREVENT SEVERE INJURY OR DEATH!  
SHUT OFF ENGINE NEAR SWIMMERS  
TO AVOID ROTATING PROPELLER BLADES.**

### **Propeller Checklist**

**At least twice a year check the propeller for:**

- Loose, missing or corroded hardware.
- Nicks, dings or missing propeller material.
- Bent propeller blades.
- Objects wrapped around the prop such as fish line.
- Decomposing propeller blades (electrolysis symptom).
- Aluminum prop with paint coming off near blade tip (ventilation symptom).
- Check the propeller pressed in rubber hub for slippage.

Contact a propeller shop or your closest Regal dealer if any of the above symptoms exist. They have special equipment to refurbish both stainless steel and aluminum propellers. After making any blade alternations the propellers are “re-pitched” in special prop jigs.



## CHAPTER 3

### Ignition Switch

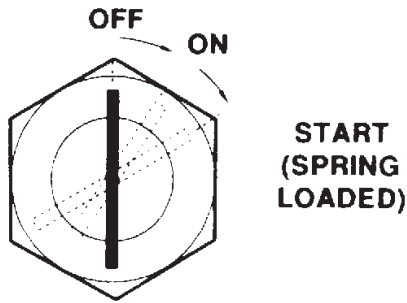

The ignition switch features 3 positions. In a clockwise direction they are off, run, and start. The start position is spring loaded and the key should be held in this position to engage the starter. Once the engine has started release the key from the start position. The electrical system will then be

energized in the run position.

Be a smart skipper and remove the ignition keys from the ignition switches with children aboard and/or when there are people in the water.

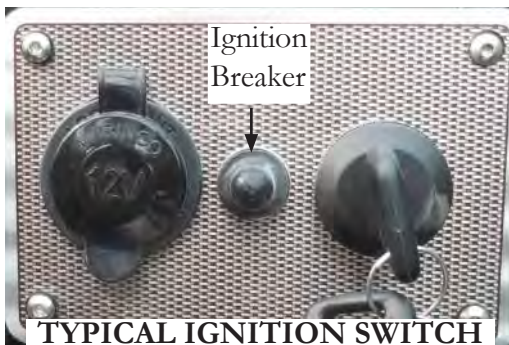

A 20 amp breaker is located next to the ignition switch. It protects the ignition and starter circuits from overloads. Should the breaker “pop” find the cause of the problem before resetting the breaker. When

considering professional assistance remember that your Regal dealer has undergone special factory training with our vessel systems and components.

## NOTICE

TO AVOID DRAINING THE BATTERY  
REMOVE THE IGNITION KEY FROM THE SWITCH  
WHEN THE ENGINE IS NOT RUNNING.



# Engines & Controls

## CONTROLS

### Typical Helm Features

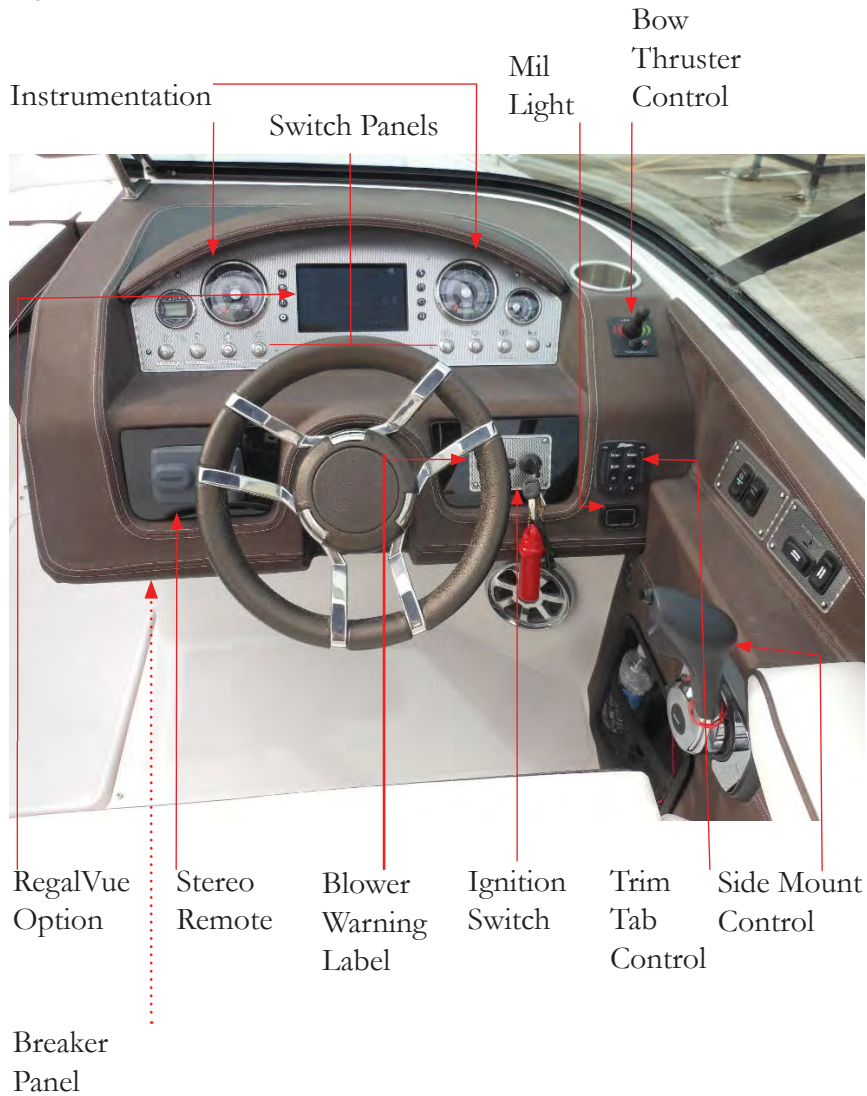



## CHAPTER 3

---

### Typical Gauge Operation

---

Following is a general description of typical gauge operations. Your vessel may not use the same gauge footprint shown below or may incorporate selected gauge readings as part of the RegalVue display. The gauges are lighted for night operation. An alert skipper monitors his gauges constantly for any system malfunctions. Gauges are an early warning system for marine engines just as they are for automobiles.



#### **Tachometer:**

The tachometer indicates the speed of the engine in revolutions per minute (rpm). The tachometer allows you to monitor the engine speed so you can be sure not to exceed the recommended limits of the engine manufacturer. *Select* tachometers include built in hour meters.



#### **Speedometer:**

This instrument used on selected vessels indicates miles per hour and kilometers per hour. Like the other gauges in the instrument cluster it is illuminated for night operation. Consult the owner's packet for additional information.



## Engines & Controls

---

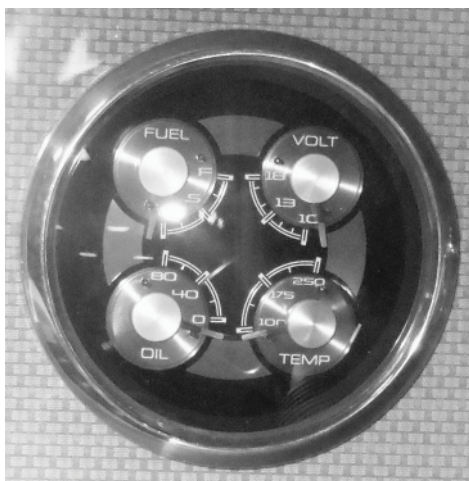

### **Multi Gauge:**

The multi gauge is standard equipment. Its function is to indicate fuel level, engine oil pressure and temperature along with DC system voltage.

Note: Vessels with the optional RegalVue will display these four gauge readings once the engine statistics button is activated.

**Fuel gauge-** indicates the level of gasoline inside the fuel tank. It is a good idea to keep the fuel tanks “topped off” when possible to reduce fuel vapors inside the tank. Also, do not run the fuel level close to empty to ensure an adequate “safety” factor. Practice the one third rule.

**Volt Meter:** monitors the battery condition as well as the alternator performance. Normal voltage is between 12.0 and 15.0 volts. Readings outside of this range may indicate a charging system or battery problem.

### **Oil Pressure:**

The oil pressure gauge indicates the pressure of the oil inside the engine lubrication system. A drop in oil pressure may be an indication of a low oil situation or a leak. Continued operation of the engines with low oil pressure could lead to engine damage. Refer to the appropriate manufacturer’s engine manual for further information.

### **Temperature Gauge**

The temperature gauge monitors the cooling system of the engine. A sudden increase in the temperature could be a sign that the engine cooling system is malfunctioning. Shut down the engine immediately and investigate the problem. Consult your engine manual for allowable limits.



## CHAPTER 3

---



### Depth Gauge:

The depth gauge is standard equipment on selected models. The depth gauge indicates the water depth under the keel of the boat. It features a shallow water alarm. By monitoring the water depth closely, damage to props and underwater hardware may be avoided.



### Trim Gauge:

This gauge measures the stern drive tilt and indicates the relative position of the bow, up or down when the boat is on plane. The power trim normally begins in the down position when used to accelerate the boat onto a plane position. The gauge can be helpful in achieving the most economical running condition.

### Gauge Lighting

---

Each gauge is designed with a night lighting device. On most models you activate the instrument lighting by energizing the navigation light switch. Eliminate condensation inside the gauges by activating the gauge lights in high humidity environments as needed.



## Engines & Controls

### Other Gauges & Indicators



If installed, the gas vapor detector determines if there is a level of gasoline vapors that is unsafe in the engine room of the boat. If installed, turn on the unit and wait about one minute for it to do its safety test. If all is well it will display a green light. You must run the test before you start the engines. In the event you don't get a green light, you must investigate the bilge of the boat for gas fumes or signs of a fuel leak before starting the engines. If uncertain, consult a marine service professional



If installed, the automatic fire extinguishing system utilizes an instrument display unit (gauge) that provides the operator with a system status of charged or uncharged condition by an audible alarm. With the ignition switch turned on the indicator light shows system is charged and operating properly. With the ignition on and no light indicates the system has discharged. If the system should discharge the ignition system will be instantaneously interrupted. Should this occur shut down the engine, ventilation blower, and any electrical system components. Investigate the source of the shutdown immediately and take appropriate action. Also, in the cockpit is located a manual release for the fire extinguishing system. Find the release and read the related sections in this manual along with the vendor's information concerning the operation of the manual release. In case of emergency inform other crew members on the operation of the fire extinguishing system.





## CHAPTER 3

---

### Typical Catalyst Engine Mil Gauge

---



Shown is a typical dash mounted engine emission status panel (mil gauge) used with catalyst engines. It provides a visual and audible (beeping alarm) means of monitoring engine and emission control systems. The panel will show the outline of an engine on the left side and a warning

sign on the right.

When an emissions related fault is detected an amber colored light will appear on the left side.

When an engine related malfunction is detected the warning sign will light amber on the right side. If the situation is serious enough there may be a significant power reduction of the engine.

If either of the above lights is lighted an audible short beep alarm will be activated.

When the engine is initially started there is a series of self-checks involving the various emission system sensors.

Read the engine manufacturer's operation manual for more detailed information on emission monitoring systems related to the particular engine brand installed on your vessel.



## *Engines & Controls*

---

### **Audible Alarms**

---

Most Volvo and MerCruiser engines use audible alarms. They are designed to use sensors which pick up deviations from the normal operating parameters. Oil pressure and temperature sensors send a signal to a buzzer under the dash which sounds a high pitched alarm indicating a possible problem.

### **NOTICE**

**PREVENT POSSIBLE ENGINE DAMAGE  
WHEN AN AUDIBLE ALARM SOUNDS  
SHUT DOWN ENGINE IMMEDIATELY,  
INVESTIGATE & REPAIR THE PROBLEM.**

On a cold start up condition you may hear an audible alarm sound when cranking over the engine. This occurs normally because it takes a second or two to build up the engine oil pressure. Then the alarm will stop.

A seasoned skipper monitors his instrument panel often while cruising.



## CHAPTER 3

---

### REMOTE CONTROL OVERVIEW

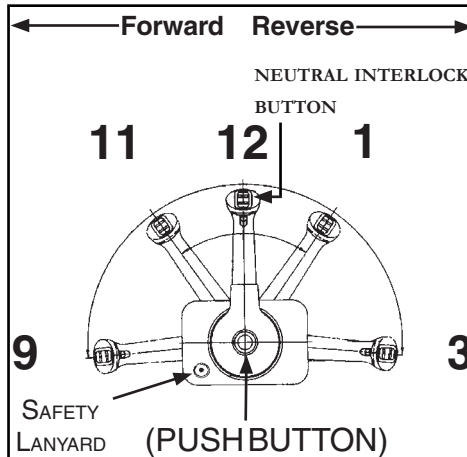

Your vessel uses a single lever side mounted controls. To help visualize the operating principals we have used a clock mode. The levers in the straight-up or 12 o'clock (neutral) position are detented and feature a push button (see illustration) which allows advancing the throttles for neutral or starting the engine without engaging the gearshifts. This

feature is useful when trying to start cold engines.

**Pushing** the throttle levers forward from the neutral 12 o'clock position to the 11 o'clock position will engage forward gear with minimum throttle. From the 11 o'clock position to the 9 o'clock position the vessel is in forward gear with forward throttle selections.

**Pulling** the throttle levers back from the neutral 12 o'clock position to the 1 o'clock position will engage reverse gear with minimum throttle. From the 1 o'clock position to the 3 o'clock position the vessel is in reverse gear with reverse throttle selections.

As you shift from neutral to forward or reverse positions, *push up on the neutral interlock button* located under the gearshift knob. This will allow the control to shift into the desired gear.

#### Neutral Safety Switch

---

The remote control features a neutral safety switch which ensures the stern drive and control handle are in the detented neutral position for starting the engines.



## Engines & Controls

---



### Typical Control

You will hear a distinct sound and will “feel” the remote control in the neutral position. If you turn the key to the “start” position and the engine starter doesn’t crank over the engine make sure the remote control is in the neutral position.

*Remember these points when shifting :*

1. Do not shift from forward to reverse gear position with the engine not running as component damage may result.
2. Do not “pump” the throttle in neutral or flooding will result. Today’s engines require very little starting throttle.
3. Do not try to shift into forward or reverse gear at high rpm’s as personal injury, drive system or property damage may result.
4. Remember to squeeze the shift interlock button to engage the remote control into forward or reverse.
4. Only use idle throttle positions when docking or maneuvering in tight quarters.
5. Never shift the controls with the engine not running. Control, linkage and or stern drive damage may occur.

\*Always attach safety lanyard to a belt or substantial garment before starting engine.

For more information on controls refer to engine operator’s manual.



---

# Systems

## ELECTRICAL

The standard electrical system on board uses a low voltage system called direct current (DC for short). It is referred to as DC because current flows one-way in the circuit.

### Direct Current (12 volt DC)

---



Storage batteries (sometimes called wet-lead cell batteries) furnish 12 volt DC electricity to boat components. Storage batteries use 2 dissimilar metals immersed in a liquid to carry current (acid). The engines require large reserve amounts of battery

power for starting purposes. Check the maintenance chapter for battery information.

The automobile battery is charged up by the engine alternator. The same holds true for the marine battery. The dash volt meter displays the battery voltage. If the volt meter shows below 12 volts there could be a charging system malfunction. This condition needs to be investigated before the batteries become completely drained.

Note: Never disconnect the battery terminal with the engine running. Never charge a battery in the boat or directly on cement. Remove the battery from the boat first. On non-maintenance free batteries check the water level periodically. Add distilled water to the proper level.

Note that tap water usually contains minerals which can be corrosive to the battery plates.



## CHAPTER 4

---

### WIRE COLOR CODES (solid color/stripe)

Color	Gauge	Function
Red	2-0000	Battery Cable To Engine
Black	16 to 0000	All Grounds
Black/White	16	Halon Fire Extinguisher
Brown	12-14	Water Pressure Pump
Brown	14	Aft Bilge Pump/Manual
Brown/Blue	16	Fwd. Bilge Pump/Manual
Brown/Black	10	Overboard Discharge Pump
Brown/White	14	Aft Auto Bilge Pump
Brown/Red	14	Fwd. Auto Bilge Pump
Brown/Pink	16	CO Detector
Yellow	12-14	Blower
Yellow/Black	16	Stereo Memory
Orange	12	Refrigerator, Hatch Ram
Orange	16	Windshield Wiper/Run
Orange/White	16	Windshield Wiper/Park
Orange/Black	16	Horn
Orange	10	Spotlight
Blue	14	Interior Lights
Blue/White	14	Cockpit Lights
Yellow/Red	14	Engine Cranking Circuit



---

## WIRE COLOR CODES (CONTINUED)

<b>Color</b>	<b>Gauge</b>	<b>Function</b>
Blue	10	Cabin Light Main Feed
Blue/White	16	Transom Courtesy Lights
Gray	14-12	Bow, Navigation Lights
Gray/White	14-12	Mast Light (Fwd. Running)
Gray/Black	14-12	Mast Light (Anchor Light)
Red/Black	16	Windlass Up
Red/White	16	Windlass Down
Red	16	Gas Vapor Detector
		Breaker To Dash
		Feed Leads
Red	6-2/0	Main DC Panel Feed
Red	2	Feed, Starter, Battery
Red	4	Feed
Red	14	Bkr. Circuit Feed, Electronics
Yellow	16	Tank Monitor
Purple	16	Hour Meter, Ignition
Green	8	Bonding
Green	16	Tank Level Monitor
Pink	16	Fuel Tank Sender Feed



## CHAPTER 4

---

Wire, color, gauge and function shown is used throughout the marine industry. The charts shown on the previous pages are helpful in identifying wire circuitry during troubleshooting or the adding of marine accessories. Never replace a wire with a size other than shown in the chart as a potential fire hazard may exist.





## DC Switches

Following is a summary of direct current switches (12 volt) and their function as found at the helm of your Regal boat. Note that electrical components and specifications can change at any time. Most switches operate as a momentary off-on type. All switches illuminate a blue glow for night operation. The symbols above the switches represent international designations.

Port Switch Panel



### Tower Up

This switch controls the Power Tower up movement. When it is activated the switch energizes twin actuators to push the tower up to a vertical position. Make sure all body parts are clear of the Power Tower when in upward motion.

### Tower Down

This switch controls the Power Tower downward movement. When activated the switch energizes twin actuators to pull the Power Tower downward to as a forward position. Make sure all body parts are clear of Power Tower when in downward motion. *Use the forward down position anytime the vessel is being towed.*

### Cockpit Lts

This switch controls the LED cockpit courtesy lights. Using these lights is especially useful when boarding or exiting the vessel at night.



## CHAPTER 4

---

### Anc Lt

This switch controls the anchor light mounted on the Power Tower. Should you anchor or stop the vessel at night the 360 degree mast light is required to be lighted.

### Starboard Switch Panel



### Nav Lt

This switch controls both the forward center line bow light and the Power Tower mounted all round light. The navigation lights sometimes called running lights must be used between sunset and sunrise. Note that the bow light can be flipped to a flush daytime position by pushing on the aft light section and turning the assembly 180 degrees. For navigation light use the component must be in the running lite position to illuminate properly through the required arcs of visibility. See the illustrations below.

FLUSH POSITION  
PUSH DOWN



NAVIGATION  
POSITION





## Bilge



This switch controls the bilge pump located at the sump floor in front of the engine. To access the pump activate the engine hatch control. The bilge pump's function is to evacuate any accumulated bilge water overboard. You can visually monitor the bilge water discharge at the

starboard aft hull fitting.

The bilge pump features an automatic float switch. In the off position the float switch activates the bilge pump as needed. This feature is especially useful when the vessel is moored and vacant. If the automatic float switch activates the pump be sure to stop the vessel and investigate the problem. Check the bilge pump before each outing and remove any foreign objects caught in the float switch or bilge pump grating. Never run the bilge pump in a dry mode since it may shorten the pump life. The bilge pump is energized even with the battery switch turned to the "off" position. Note in the illustration above that the bilge pump is red and the automatic float switch is white.

## Blower



This switch controls the bilge ventilation blower. The blower's function is to evacuate any fumes and engine exhaust gases that have accumulated in the lower bilge. The blower must be activated at least 4 minutes prior to starting the engine. Check the ventilation ducts and black bilge hose to ensure they are not obstructed. Be careful not to step on the bilge

hoses when performing sump maintenance. The blower should be used below cruising speeds.

Read and understand the warning on the following page.



## CHAPTER 4

---



### **WARNING**

GASOLINE VAPORS CAN EXPLODE. BEFORE STARTING ENGINE, OPERATE BLOWER 4 MINUTES AND CHECK ENGINE COMPARTMENT FOR GASOLINE LEAKS OR VAPORS. RUN BLOWER BELOW CRUISING SPEED.

#### **Horn**

This switch controls the audible electric horn signal. The horn is located at the starboard forward hull. It is protected by a stainless grille cover. Be sure to test the horn before each outing and become familiar with all horn and bridge signals.



## Additional DC Switches/Panels

Your Regal boat may display additional switches or possibly switch panels based on select equipment installed or possible options on board. It is possible that component switches may be in a different order on the switch panel verses what is shown in this section.



### Hatch

This switch controls the engine hatch. When the upper portion of the switch is energized and held the engine hatch raises using two electric rams. The hatch is completely

raised when you hear the system make a ratchet noise. Do not continue to run the hatch actuators at this point. When the bottom portion of the switch is energized and held the engine hatch is lowered. The hatch can ratchet at the end of the down stroke if the switch is held closed.



## WARNING

AVOID PERSONAL INJURY!  
KEEP BODY PARTS AWAY FROM A MOVING HATCH.

### Cockpit Lts.

This switch controls the LED formatted cockpit lights. When activated they will provide safer access to stern for entering and exiting along with general cockpit lighting. These lights illuminate blue, feel cool to the touch and should last much longer than other type bulbs. These fixtures are based on the latest semi-conductor technology.



## CHAPTER 4

---

### Underwater Lts.

This switch controls the LED formatted blue underwater lights mounted on the hull in the transom area. These lights can be helpful in docking and tight maneuvering or just for general lighting. They can be used to attract bait fish.



### Panel Lt.

This switch controls the illumination of the dash gauge lights. When the upper portion of the momentary switch is pressed and held the dash gauge lights become

brighter. When the lower portion of the momentary switch is pressed and held the helm gauges become dimmer. The center switch position is the off position.

### Wiper

This switch controls the optional driver windshield wiper. Never run the windshield wiper blade over a dry windshield as permanent marking of the glass may occur.

### Dock Lights

This switch controls the optional hull mounted docking lights. They are useful for night mooring and tight maneuvering. **Avoid using docking lights for general navigation as they may interfere with the bow mounted navigation light arcs of visibility.**



## Helm Seat Control



The horizontal positioned switch controls the helm seat movement. Pressing the momentary forward portion of the switch moves the seat toward the bow. Pressing the momentary aft portion of the switch moves the seat toward the stern. The

center switch position is “off”.

The vertical positioned switch controls the up and down seat movement. Pressing the momentary upper portion of the switch moves the seat up. Pressing the momentary lower portion of the switch moves the seat down. The center switch position is “off”.

## Tower Lt.

This switch controls the overhead light on the Power Tower.

## Power Platform

This switch controls the optional underwater electric power platform. The upper portion of the switch when activated moves the power platform to the up position. The lower portion of the switch when activated moves the power platform to the down position and at this point be used as a swim step.



## CHAPTER 4

---

### DC Circuit Protection

---

As part of the direct current circuitry the engine features a breaker with a reset button or an in-line fuse. These engine overcurrent devices protect the engine wiring from overloads. Refer to the engine manufacturer's manual for the device location and operation.

Also, a fuse panel and breaker panel at the helm protect DC components. If they "blow" due to an overload, they can be replaced at the panel under the helm. Replace with the same amperage and type. Carry extra fuses which are available at marine supply stores or the closest Regal dealer parts department. Refer to your engine manual for additional information.

### Battery Switch

---

A battery switch is installed on the house and engine cranking circuits. See the section on the battery management panel for operating instructions.

## NOTICE

AVOID DAMAGE TO THE ALTERNATOR  
AND OR CHARGING SYSTEM COMPONENTS.  
NEVER TURN THE BATTERY SWITCH TO THE "OFF"  
POSITION WITH THE ENGINE RUNNING.





## FUEL

### Fuel System-General Information ---

Gasoline Requirements- Use non-leaded gasoline with the following minimum octane rating:

- Inside United States- (R+M)2 (AK)- 87
- Outside United States- (RON) -90

The use of leaded fuels will damage the catalysts and can not be used with catalytic converters.

Gasoline in the United States and other areas is blended with 10% ethanol and is known as E-10 at the pumps. Marine engines used in your Regal boat may be operated with gasoline blended with no more than 10% ethanol and that meets the minimum octane specification.

*Do not use ethanol blends greater than 10%* such as a newer blend for select motor vehicles called E-15. Your marine engine may be damaged by more than 10% ethanol. A loss of performance may occur and the engine may not be covered by the engine manufacturer's warranty.



## CHAPTER 4

---

### TYPICAL EPA COMPLIANT FUEL TANK

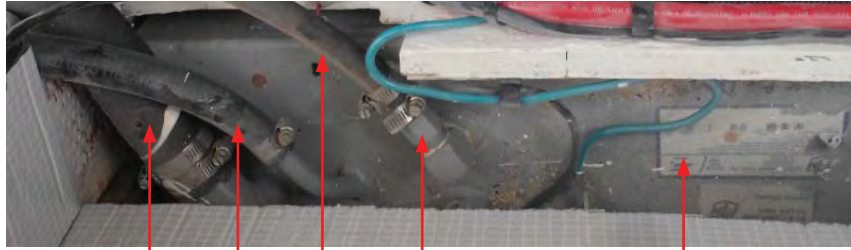

FILL HOSE

VENT HOSE

FEED HOSE

ANTI-SIPHON VALVE

FUEL TANK LABEL



### Fuel System

---

The fuel system consists of a fuel tank, fuel fill fittings, fuel hoses, fuel vents, anti-siphon valve, internal tank valves, fuel filter, fuel gauge and sender. Each one of these components plays an important role in providing an uninterrupted flow of fuel while operating your boat. Refer to the technical drawing section for system specifics.

### Fuel Tank

---

Your boat uses an aluminum or polyester fuel tank. *Boats manufactured for domestic use are now required to be EPA compliant and will be outfitted with an aluminum tank.* This system uses parts such as a valve located inside the fuel tank and can not be serviced. Also, there is a carbon canister which functions much like the one in an automobile located between the fuel tank and hull side vent. This canister under normal usage requires no service. These tanks are tested along with the complete fuel system for safety requirements and quality in house. Also, they are inspected independently by National Marine Manufacturers Association personnel.

### Fuel Fill

---

The fuel fill fitting is labeled “gas” and in addition displays the international symbol (See the next page). When fueling the boat keep the fill nozzle in contact with the fuel fill pipe since it decreases static electricity. Always use the recommended fuel octane rating as specified in your engine owner’s manual.

*Extinguish all flame producing agents before fueling!*



## CHAPTER 4

---

### Fuel Vents

---

Currently, domestic EPA compliant fuel tanks vent fumes back into the fuel tank system. While the tank is filled, air displaced by the incoming fuel is vented through the fuel system charcoal canister.



#### COMBO FUEL FILL W/ INTERNAL VENT

Your vessel uses a combo type (internal vented) fuel fill. Both the fuel fill and vent occupy the same cavity under a protective cover. If fuel overflows through the vent the design forces it back into the fuel fill hose and tank.

A seasoned skipper will hear a distinct sound as the tank nears the “top out” or full mode and may see fuel overflowing back into the fuel hose through the vent. **DO NOT OVERFILL THE TANK.** This helps avoid any overboard spills which harm the environment. There is a key that fits the fuel fill. Use it to secure the fitting from leaking fuel. Store the key in a safe place so it can be easily found for fueling. Check the vent fill screen periodically for debris.

### Anti-Siphon Valve

---

The fuel tank feed line use an anti-siphon valve. The valve is threaded into the fuel tank fitting at the feed line. The valve is pulled off its seat by fuel pump pressure as the engine is cranking or running. It allows a one-way fuel roadway to the engine fuel pump . It prevents fuel from siphoning out of the tank in the event of a fuel line rupture or disconnected fuel feed hose. Never remove an anti-siphon valve as it is a fuel system safety component. Clean or replace a clogged or stuck anti-siphon valve. Contact your closest Regal dealer or marine professional for more information.



### Fuel Gauge & Sender

---

The dash fuel gauge is only an indication of the on board fuel supply. They are not exact reading instruments. Therefore, use the one third rule discussed earlier for monitoring your fuel supply. *There are not many filling stations on the open waterways!* The gas sender located in the fuel tank uses a float system which sends a signal to the dash fuel gauge as to the fuel tank level.

### Fuel Filters

---

Fuel filters are installed on marine engines. They are of the spin on type similar to an automobile oil filter. Their main purpose is to trap dirt particles and condensation in fuel. It is a good idea to keep an extra fuel filter on board along with a filter wrench, catch container and clean rags for emergencies. Never use automotive style fuel filters on your vessel. Dispose of all fuel residue materials in an environmentally safe fashion.



# CHAPTER 4

## FRESH WATER

### WATER FILL



Your vessel is equipped with a fresh water supply system. It consists of a water tank, fill fitting, sink, drain hose, faucet and transom shower. Water is supplied by a fresh water pressure pump. A water fill fitting is normally located on the deck area. It features an internal vent. When the water tank reaches full capacity water will be seen cycling from the vent into the fill hose. To energize the system there is a dash switch marked fresh water pump. When activated the switch sends power to the pressure pump which supplies fresh water. When the water supply line is full a pressure valve switch releases and the fresh water pump stops.



*We recommend turning the water pressure switch “off” when the vessel is left for extended periods.*

For initial filling of the water system and winterizing refer to the operation and maintenance sections. The master on-off fresh water system switch is located at the head 12 volt manual. Pull switch out to activate fresh water system. Push switch in to deactivate the fresh water system. Note that this switch utilizes a built in circuit breaker. Should it “pop” determine the cause and reset the breaker. Note that select breakers on the 12 volt panel may be for options.



FRESH WATER SWITCH/BREAKER

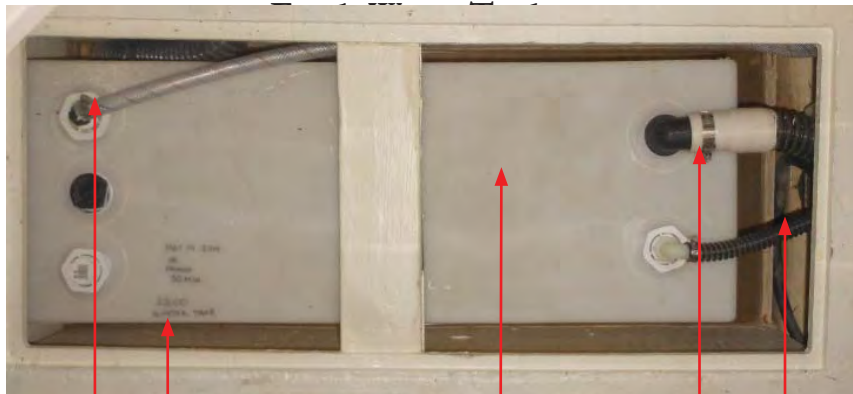

**FEED HOSE**                      **LABEL**                      **WATER TANK**                      **FILL HOSE**                      **VENT HOSE**

These are the main fresh water system components. The fill is located at the port front bow. The water tank itself is found amidships at the helm walk-thru to the bow. It is beneath the cockpit floor. Periodically check hose clamps for tightness.

Note that if the fresh water pump continues to run now and then without the head faucet or transom shower/washdown being activated it may be a sign of a system leak. Check all system hoses and clamps for proper tightness.



## CHAPTER 4

---

### WASTE

#### Chemical Toilet

---

Installed as standard equipment on your vessel is a self-contained sanitation device known as a chemical toilet featuring an upper fresh water tank and a lower deodorized tank. These two components can be separated for waste disposal, cleaning and refilling. The lower tank contains a capacity gauge. Before each outing check the waste level since it is illegal to dump waste within and extending out to the United States territorial limit.

Refer to a typical system shown on the following page. For more information, review the vendor manual supplied in the owner's information packet or visit their on-line location.

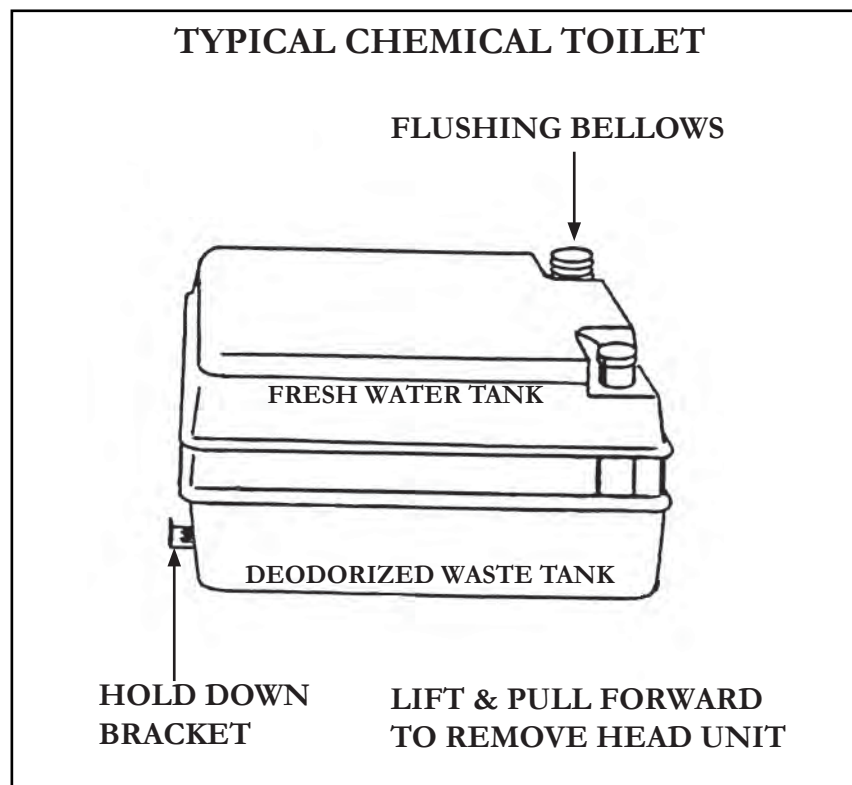





# *Vessel Operation*

## GETTING UNDERWAY



This chapter explores the many phases of running your vessel from casting off to docking and handling emergencies. We cover the basics but suggest you read other information on the chapter topics. Also, become familiar with

your engine owner's manual since many of the items discussed here are found there in further detail.

### Pre-Departure Questionnaire

- Have all fluid levels been topped off?
- Is the fuel tank full?
- Is all safety equipment accounted for and easily accessible?
- Are navigation lights and horn operating properly?
- Is the bilge free of water and does the bilge pump operate?
- Is the engine, stern drive, and propeller in good working condition?
- Is the drain plug in place ?
- Have all passengers been briefed on emergency procedures and seated for departure? Is the boat load balanced?



## CHAPTER 5

---

- Is the operator sober, alert and ready to skipper the vessel?
- Have all passengers been fitted for life jackets?
- Has a float plan been filed and left with a component person?
- Has the bilge been sniffed and the fuel system leak checked?
- Are the seacocks open (if applicable)?
- Is all communication equipment in good operating condition?
- Has a second person been briefed on operational procedures should the skipper become disabled?
- Are all gauges and electrical switches functioning properly?
- Has weather information been gathered and analyzed?

### Underway Questionnaire

---

- After casting off have all dock lines and fenders been stowed?
- Are all passengers seated and all transom doors closed?
- As skipper are you monitoring the dash gauges for changes?
- As skipper are you on the lookout for changing weather?
- As skipper are you checking for abnormal vibration?
- Is the remote control safety lanyard (if equipped) tightly secured to your belt or clothing?



## Vessel Operation

---

### Disembarking Questionnaire

---

- Have you removed the keys from the ignition and secured them?
- Have all systems been checked for leaks?
- Has the battery switch been turned to the “off” position?
- Are all seacocks closed?
- Has the fuel tank been filled enough to prevent condensation?
- Is the vessel properly tied and covered with equipment stored?

### FUELING

	<b>DANGER</b>
<p>AVOID PERSONAL INJURY OR DEATH! GASOLINE IS A HIGHLY FLAMMABLE AND EXPLOSIVE MATERIAL. PRACTICE “NO SMOKING” AND EXTINGUISH ALL FLAMMABLE MATERIALS WITHIN 75 FEET OF THE FUEL DOCK.</p>	

	<b>WARNING</b>
<p>AVOID SERIOUS INJURY OR DEATH FROM EXPLOSION OR FIRE RESULTING FROM LEAKING FUEL. INSPECT ENTIRE FUEL SYSTEM AT LEAST ONCE A YEAR.</p>	



## CHAPTER 5

---

### NOTICE

SINCE GASOLINE IS AVAILABLE IN SEVERAL GRADES INCLUDING ETHENOL & VARIOUS OCTANE LEVELS, REFER TO THE ENGINE MANUFACTURER'S OWNER'S MANUAL FOR THE CORRECT ONE FOR YOUR ENGINE. USING IMPROPER OCTANE FUEL CAN CAUSE ENGINE DAMAGE AND VOID THE WARRANTY.

#### Before Fueling

---

- Make sure a working fire extinguisher is available.
- Stop engines and any device that can cause a spark.
- Disembark all passengers and crew not needed for fueling.
- Fuel if possible during the daylight hours.
- Check to ensure nobody is smoking in the boat or near the fueling dock.
- Close all portholes, hatches and doors to keep vapors from blowing aboard and settling in the bilge.
- Tie up your boat securely at the fuel dock.
- Identify the fuel fill. Unfortunately, people have mistakenly filled the water or waste with fuel.
- Visually inspect all fuel system components before each filling.
- Avoid using fuels with alcohol additives. They can attack fuel system hoses and cause deterioration.



## Vessel Operation

---

### During Fueling

---

- ☑ Keep the fuel nozzle in contact with the fuel fill to guard against static sparks. The fuel fill pipe is grounded through the fuel system wiring to protect against static electricity.
- ☑ Avoid overfilling the fuel tank. Leave room for expansion. Also, if fuel exits the fuel vent indicating the tank is full, this situation is dangerous and unfriendly to the environment.
- ☑ Avoid spilling any fuel. Clean up any fuel accidentally spilled with a clean rag and dispose of it onshore.

### After Fueling

---

- ☑ Close all fuel fill openings tightly. Use a fuel key if needed.
- ☑ Open all portholes, hatches and doors.
- ☑ Energize the blower for a minimum of 4 minutes.
- ☑ Sniff in the lower bilge and engine compartment for gas fumes. If fumes are detected continue to ventilate until the odor is gone. Look for any traces of fuel droplets or spillage. **Do not start the engines, smoke or run any electrical components except the blower until the fumes can no longer be detected.**



## WARNING

AVOID SERIOUS INJURY OR DEATH!  
THE OPERATOR OF THE CRAFT MUST HAVE  
COMPLETE CONTROL OF THE HELM STEERING  
STATION WHILE THE VESSEL IS MOVING.  
NEVER LEAVE THE HELM STATION UNATTENDED  
WHILE THE VESSEL IS MOVING.



## CHAPTER 5

---

### STARTING & STOPPING

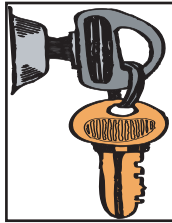

The following general information covers starting and stopping your engine. Read and understand all previous information on remote controls, fueling and operational procedures. Pay particular attention to all labels. Refer to the engine owner's manual for in depth propulsion system information.

#### Starting Guidelines

---

Review all pre-departure information. Before starting your engine make sure all canvas is removed and stored. Start engine only in a well ventilated location to avoid CO buildup. Turn the battery switch to the number 1 or 2 position.

Set the remote control handle in the neutral position. Advance the neutral throttle position as instructed in the engine owner's manual. Connect the safety lanyard to a belt or secure to clothing such as a pants belt loop. Keep passengers seated and away from controls.

Turn the ignition key to the momentarily start position. You will hear the starter cranking over the engine. When the engine starts release the key switch. It will automatically align itself in the run position (ignition).

If the engine does not start, refrain from cranking the engine over 10-12 seconds. Allow the starter and battery a chance to recover. Advance the remote control in the neutral throttle position as recommended in the engine manual. Do not race the remote control in the neutral position.



## Vessel Operation

---



### WARNING

GASOLINE VAPORS CAN EXPLODE. BEFORE STARTING ENGINE, OPERATE BLOWER 4 MINUTES AND CHECK ENGINE COMPARTMENT FOR GASOLINE LEAKS OR VAPORS. RUN BLOWER BELOW CRUISING SPEED.



### CAUTION

TO AVOID ENGINE DAMAGE!  
CHECK THE OIL GAUGE IMMEDIATELY AFTER STARTING. IF LOW OR NO READING SHUT DOWN ENGINE IMMEDIATELY AND INVESTIGATE THE PROBLEM.

### Shifting Guidelines

---



Before shifting into reverse or forward gear positions make sure the coast is clear. When shifting to either gear from neutral make sure the throttle is in the idle position. Allow your vessel to lose all headway before shifting into reverse or forward gear. Practice shifting! You will become more familiar with the procedure and self-confidence will build especially in tight docking situations. Stay alert at all times!



## CHAPTER 5

---

### Stopping

---

Before stopping the engine make sure it is in neutral and idle speed. After an outing let the engine cool down at idle speeds for a few minutes before turning the ignition off. Glance at the gauges one last time to monitor their readings. Never turn off the engine while in forward or reverse gear since water could enter the engine through the exhaust system and cause extensive damage. The same holds true for running the boat in reverse. Above all, use common sense.

## STEERING

Non-electronic steering engines use a rotary or rack style steering system. These systems transfer helm mechanical motion to the engine. There is a hydraulic steering cylinder which with the assistance of a steering pump sends fluid force to the stern drive steering arm changing the course of the boat, depending on the direction the steering wheel is turned.

Since the steering system is the primary link for engine control, it must be periodically inspected and maintained. The hardware at both the helm and engine must be checked regularly for tightness.

Check the steering system for full steering port and starboard before disembarking. Refer to the steering manufacturer's literature in the owner's pouch and the maintenance chapter for more information.



### **WARNING**

**AVOID PERSONAL INJURY AND PROPERTY DAMAGE!  
LOOSENING OR LOSS OF ONE OR MORE FASTENERS  
MAY CAUSE FAILURE OF THE STEERING SYSTEM  
OR DAMAGE TO THE STEERING CABLE,  
RESULTING IN LOSS OF STEERING CONTROL.  
PERIODICALLY INSPECT THE STEERING SYSTEM.**



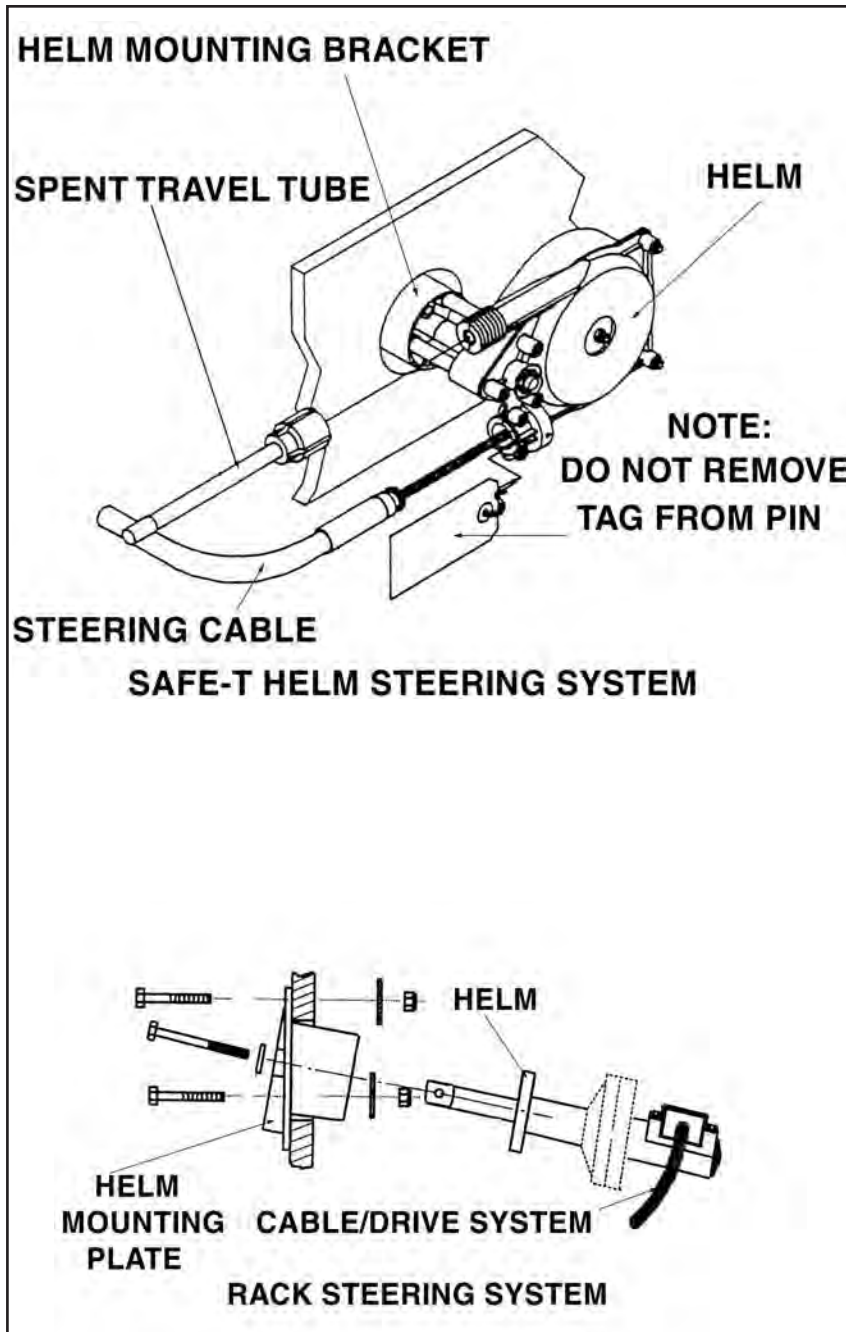



## CHAPTER 5

---

### FENDERS

#### Fender Usage

---

Fenders are made of a rubberized plastic and are usually filled with air. Most have a fitting like a basketball so they can be inflated or deflated. Fenders are available in a wide range of sizes and shapes to fit both small and large vessels. Fenders are normally designated in inches. They are used between piers, docks, sea walls and the boat. They protect the top sides of the boat from rubbing against rough objects. Most fenders have eyes of attachment which allow a line to be inserted vertically or horizontally. This will permit the fender to be tied off to fit a variety of marina, dock and tidal situations. Be sure the fender is correct for the vessel size. It is a good idea to carry extra fenders but half a dozen is normally an acceptable number. Remember to store fenders on board so they can be easily accessed. Some people incorrectly call fenders “bumpers”.

#### Fender Types

---



There is a variety of fender styles and types, each selected for specified uses. When choosing fenders, contact a marine dealer or supply house. Explain how you moor and use your vessel so they can recommend the best fender type for you. We suggest the type with a fill plug so you can inflate them with a hand pump like the ones used for bicycles.



### DOCK LINE BASICS

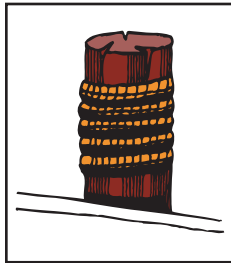

Most skippers use dock line terminology fairly loose but there is more to the basics than just bow or stern lines. There are several lines that can be secured to the bow and stern and depending on their direction and use, can be called other names. Remember that “forward” and “aft” refer to the direction that a spring line runs from the vessel, and not where it is secured on board.

#### Bow & Stern Lines

---

There is only one true bow line. It is secured to the forward cleat and run forward along the dock to prevent the vessel from moving to the stern. The stern line leads from a rear cleat to a piling or cleat on the dock astern of the vessel. This line keeps the boat from moving ahead. For small vessels these are the only lines needed for normal wind and current conditions. If located in a tidal environment, keep slack in the lines.

#### Breast Lines

---

These lines are attached to the bow and stern that lead to nearly right angles from the center of the vessel to the dock. They help keep larger vessels from moving away from the dock, or are pulled in to help people board the vessel. Larger vessels may use bow or quarter breast lines.

#### Spring Lines

---

Most small boats use two spring lines although it is possible to have four. They are called the after bow spring and forward quarter spring.



## CHAPTER 5

---

Bow springs are secured at the vessels bow area. Forward spring lines lead forward from the boat to the dock and control movement toward the stern. After springs stem aft from the vessel, and stop movement ahead. Spring lines are used to prevent movement in a berth, ahead or astern. They are really useful in controlling the effects of a real active tidal surge. Spring lines are useful where fenders need to be kept in place against piles.

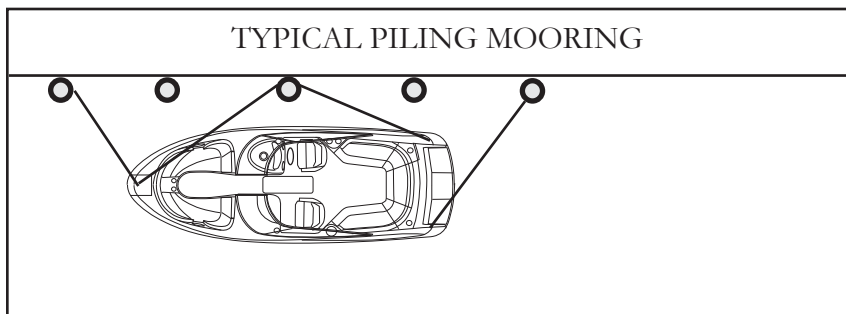
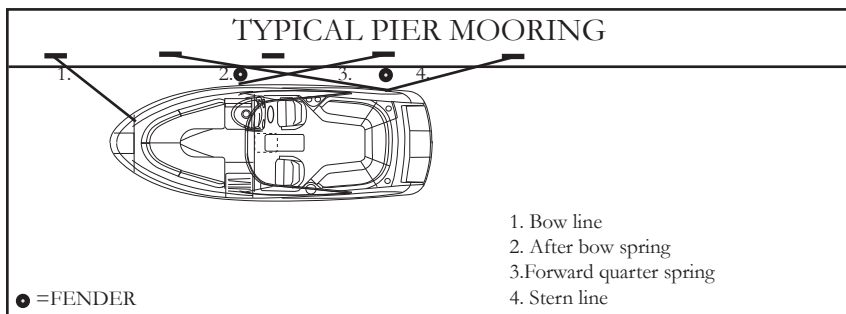

### Boat Mooring

---

Most boats can be secured to a dock using four lines. The after bow spring is crossed with the forward quarter spring and secured to individual dock cleats or pilings. This ensures longer springs and can be snugged up tighter for more efficient tidal control. Remember, if you only have one piling available, position the vessel so this point is opposite amidships. Run both spring lines to it. These lines will be shorter but still useful.



## *Vessel Operation*

---

The bow and stern lines should be relatively at a 45 degree angle with the dock. The stern line can be attached to the near-shore quarter cleat, but will work more efficiently to the offshore quarter cleat. The longer line will allow the boat flow with the tide with less time checking the vessel.

### **Dock Line Sizing**

---

Most dock lines today are made of nylon, either of twisted rope or braided core and cover. The most often used material is nylon because of its stretching abilities absorbing shock loads. It is chafe resistant for extended life and is easier on bare hands.

The line's size varies with the vessel. Normally, a vessel in the 20' to 40' boats will use 1/2" diameter nylon lines. Larger yachts use 5/8" and 3/4" diameter nylon lines. Smaller boats can use 3/8" nylon lines.

Dock lines need to have the strength to hold the vessel and have enough density to resist chafing. They shouldn't be too heavy that they lose their shock-absorbing capabilities. Use the right size line for the vessel since a line too large for the boat will pull hard against the vessel since it won't be forced to stretch. If the line is too small for the vessel, there is no margin for wear and chafe when under strain.

### **Securing Lines**

---

When mooring your boat, make sure the dock lines are secured at both ends. Depending on your situation you may need to loop the eye splice of the dock line around a piling. Sometimes the mooring line will lead down sharply from the piling to the deck cleat. Loop the eye splice around the piling twice to keep it from being pulled up off the pile. Pull the line through the looped eye if the mooring line is too small to go around the piling twice or too small to fit over once.

If you must drop a line over a piling that already holds another boat's line, run the eye of the line up through the first eye from below, then loop it over the pile. This will allow either line to be removed without disturbing the other.



## CHAPTER 5

---

If another line is dropped over yours, simply reverse the process. Secure a little slack in the other dock line, then slip your eye up through its loop and over the top of the pile. Your line can be dropped through the other eye.

When debarking from a dock, it is easier to release the line from a cleat or piling, from on board the boat, as soon as you leave the dock. Loop a long line around the cleat or pier and leading both ends on board you can release the line easily. Slip one end around the cleat or pile, then pull it back on board. Release the line without the eye splice, so it will run freely from around the pile without hanging up on the splice.



### STERN DRIVE DOCKING

Stern drive powered boats are fairly easy to back up and maneuver with a little knowledge and docking practice. One of the most important aspects of the process is to keep your calm in the wake of a busy marina. Basically, the reversing propeller is turned in the direction you want to go by using the wheel.

Some boats tend to be influenced by the wind. When backing down in a crosswind, allow room to maneuver and watch the bow. Try not to overreact or get excited, but use your knowledge and experience. If the wind begins to swing the bow, you need to stop backing, turn the wheel to port and go forward to straighten the boat. Use a quick burst of power but not too much to knock your crew off balance.

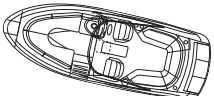

A. Stop the boat by shifting in reverse. Put the wheel over to the port and begin backing in. Slow down your speed by momentarily shifting into reverse.

**\* Control in reverse idle position, Outdrive to port.**

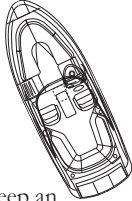

B. Continue backing up the boat with the wheel hard to port. Keep an eye on the bow, and begin to straighten the wheel as the boat enters the slip.

**\* Control in reverse idle position, Outdrive to port.**



## CHAPTER 5

---

C. Center the wheel to align the boat parallel with the dock.  
If the stern is too far from the dock, shift to neutral,  
then put the wheel hard over to port and then go forward  
a second or two.

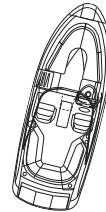

**\* Control in neutral idle position. Drive centered.**

D. When the boat is completely into the dock, stop stern movement  
by shifting into forward. Put the wheel to port to kick the stern over  
close to the dock if necessary. Shift into neutral and tie up the boat.

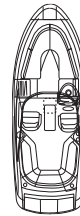

**\* Control in forward idle position. Drive to port.**





### **STERN DRIVE MANEUVERING**

Stern drive boats do not have rudders. The boat uses a steering system that directs the propeller thrust, by turning the stern drive unit where the propeller is mounted. Normally maneuvering an I/O boat is easier than a similar single screw vessel.

Directing propeller energy (thrust) makes slower speed maneuvering easier. The propeller discharge current is turned from one side to the other which results in turning forces. Rudder boats need water to flow by the rudder to be efficient. Stern drive units are designed to have reduced shaft angle, so the propeller does not produce as much unequal blade thrust and resistance as does a propeller on a single screw boat. Large horsepower stern drive boats produce more thrust and steering torque but Regal boats use power steering. Below is some basic information on how single stern drive boats handle in normal conditions.

#### **Gathering Headway**

---

When a stern drive is not moving forward or reverse in the water and the propeller is not turning, (shift in neutral) the boat will not react to the helm steering wheel.

As soon as the vessel is shifted into forward gear the propellers action creates a discharge motion and generates energy in the form of thrust. If the stern drive is centered, the discharge motion is directed straight back causing the vessel to advance forward.

You may notice that if you advance the throttle quickly in initial take-off (make sure you have a firm grip on the wheel), the boat has a tendency to pull the stern of the vessel to starboard. There is a trim tab (also serves as a sacrificial anode) located on the vertical drive housing just to the top of the propeller blade. This trim tab helps compensate for the low speed steering torque. Once the boat increases headway the propeller is operating in a faster water flow this torque effect decreases. Sometimes the trim tab may need adjustment on stern drive models. Contact your Regal dealer for further information or consult your engine manufacturer's manual.



## CHAPTER 5

---

### Turning

---

Once the boat has gathered headway, with the boat planing at the correct bow angle and the stern drive unit and helm straight the boat tends to stay on a uniform course heading. To assure the boat trim angle is correct use the trim gauge as a guide while activating the trim button on the remote control panel.

When the helm wheel is turned to the right or starboard, the stern drive unit is turned in the same direction. The propeller's discharge force is directed to starboard forcing the boats stern to port. Water flowing past the hull strikes the stern drive gear housing in its starboard side, creating additional turning torque. The stern starts a move to port, forcing the bow to starboard.

If the helm is turned to the left or port the stern drive turns to port, the stern of the boat goes starboard as the bow turns to port.

As the vessel operator gains experience, he will better gauge each maneuver and speed situation. In this way he will understand the handling characteristics of his boat. He needs to keep the safety of his passengers in the highest priority.



## Vessel Operation

---

### Backing Down

---

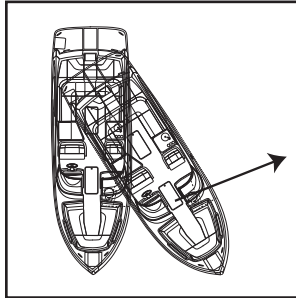

Stern drive boats do not have rudders. The boat uses a steering system that directs the propeller thrust, by turning the stern drive unit where the propeller is mounted. Normally maneuvering the I/O boat is easier than a similar single screw vessel.

If your boat has the steering wheel and stern drive straight with the control in reverse, the stern will be pushed a bit to port by the reversing propeller thrust. This tendency to back to port can be eliminated by turning the stern drive to starboard.

### Stopping

---

Remember that your boat does not have any brakes. It uses reverse thrust from the propeller to stop. If the vessel has headway, with the helm and propeller in reverse the propeller thrust is directed backwards, past the lower gearcase of the stern drive.

Depending on how far the throttle is advanced, the discharged thrust may not be strong enough to reverse the water flowing by the gearcase. As the power is increased, the propeller thrust becomes strong enough to stop the flow of water past the lower unit, and, as the throttle is advanced it reverses its flow more completely.

When water is flowing past the gearcase, steering torque is increased, but when the thrust stops the water flow, the boat will not respond to the helm. This is a short lived event and is overcome quickly when the water again flows past the gearcase.



## CHAPTER 5

---

### TRIM ANGLE

---

Stern drive boats have the ability to angle in or out their drive unit in relationship to the transom. This is accomplished by hydraulic shocks located on the stern drive along with an electrical sender unit that reads the drive angle and sends information to the dash trim gauge showing a reading.

#### **Purpose Of Power Trim**

The purpose of the power trim/tilt is to enable the operator to change the angle of the drive while at the helm. Changing the angle of the drive or “trimming” provides the following benefits:

1. Improves acceleration onto a plane.
2. Maintains boat on plane at reduced throttle settings.
3. Increases fuel economy.
4. Provides smoother ride in choppy water.
5. Increases top speed.

In short, it is a way of fine-tuning the ride of your boat and will enable you to get the most efficient and comfortable ride possible, whatever the conditions.



## *Vessel Operation*

---

### **Use Of Power Trim**

---

The power trim is normally used prior to accelerating onto a plane, after reaching the desired RPM or boat speed and when there is a change in water or boating conditions. Position passengers and equipment in the boat so that the weight is balanced correctly fore and aft as well as side to side. Trimming will not compensate for an unbalanced load. To operate the trim, push the switch until the desired bow position is reached. The trim may be operated at any boat speed or at rest. Avoid operating the trim system when running in reverse. Observe the trim/tilt gauge which indicates the boat's bow position achieved by the trim angle of the vertical drive unit. "Bow-Up" corresponds to the upper portion of the trim range on the gauge while "Bow Down" corresponds to the lower portion of the trim range on the gauge.

To determine the proper trim angle, experiment a little until you are familiar with the changes in your boat. The vessel will be properly trimmed when the trim angle provides the best boat performance for the particular operating conditions. A trim position that provides a balanced steering load is desirable.

To familiarize yourself with the power trim, make test runs at slower speeds and at various trim positions to see the effect of trimming. Note the time it takes for the boat to plane. Watch the tachometer and speedometer readings as well as the ride action of the boat.



## CHAPTER 5

---

### Operation In “Bow Up” Position

---

The “Bow Up” or out position is normally used for cruising, running with a choppy wave condition, or running at full speed. Excessive “bow up” trim will cause propeller ventilation resulting in propeller slippage. Use caution when operating in rough water or crossing another boat’s wake. Excessive “bow up” trim may result in the boat’s bow rising rapidly, creating a hazardous condition.

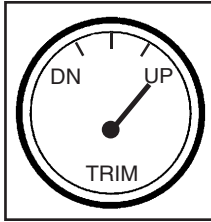

### Operation In “Bow Down” Position

---

The “Bow Down” or in position is normally used for acceleration onto a plane, operating at slow planning speeds, and running against a choppy wave condition. It is also used when pulling water skiers, tubers, kneeboarders, etc. In this position the boats’ bow will want to go deeper into the water. If the boat is operated at high speed and/or against high waves, the bow of the boat will plow into the water.

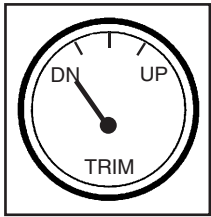

### Operation In “Level” Position

---

In normal running conditions, distribute passengers and gear so boat is level. At or below cruising speeds, trim the vessel for optimum performance. The trim gauge will show somewhere in the center of the gauge. This position will also enhance running visibility and overall stability. Again, each outing provides different wave, load and running conditions. Be prepared to make trim changes as needed.

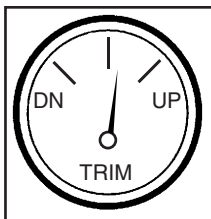



 <b>CAUTION</b>
THE BOAT TRIM SHOULD BE ADJUSTED TO PROVIDE BALANCED STEERING AS SOON AS POSSIBLE EACH TIME YOU GET UNDERWAY. SOME BOAT/ENGINE/ PROPELLER COMBINATIONS MAY CREATE BOAT INSTABILITY AND/ OR HIGH STEERING TORQUE WHEN OPERATED AT OR NEAR THE LIMITS OF THE “BOW UP” OR “BOW DOWN” POSITIONS. BOAT STABILITY AND STEERING TORQUE CAN ALSO VARY DUE TO CHANGING WATER CONDITIONS. IF YOU EXPERIENCE BOAT INSTABILITY AND/OR HIGH STEERING TORQUE, SEE YOUR AUTHORIZED REGAL DEALER.

### Shallow Water Operation

---

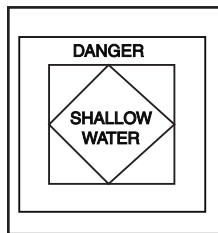

Operating your vessel in shallow water presents various hazards. You are more apt to hit a submerged object such as a rock, sand bar, stump coral, or other unmarked objects.

Pay close attention to your charts for descriptions of any shallow areas along with marked submerged objects. Always post a lookout when operating in shallow water. Trim your drive up as needed to

provide adequate draft. Set the alarm on your depth sounder and travel at a speed that will keep the boat level in these shallow areas.

**If your boat strikes a submerged object stop immediately and check for hull, outdrive and propeller damage.**



## CHAPTER 5

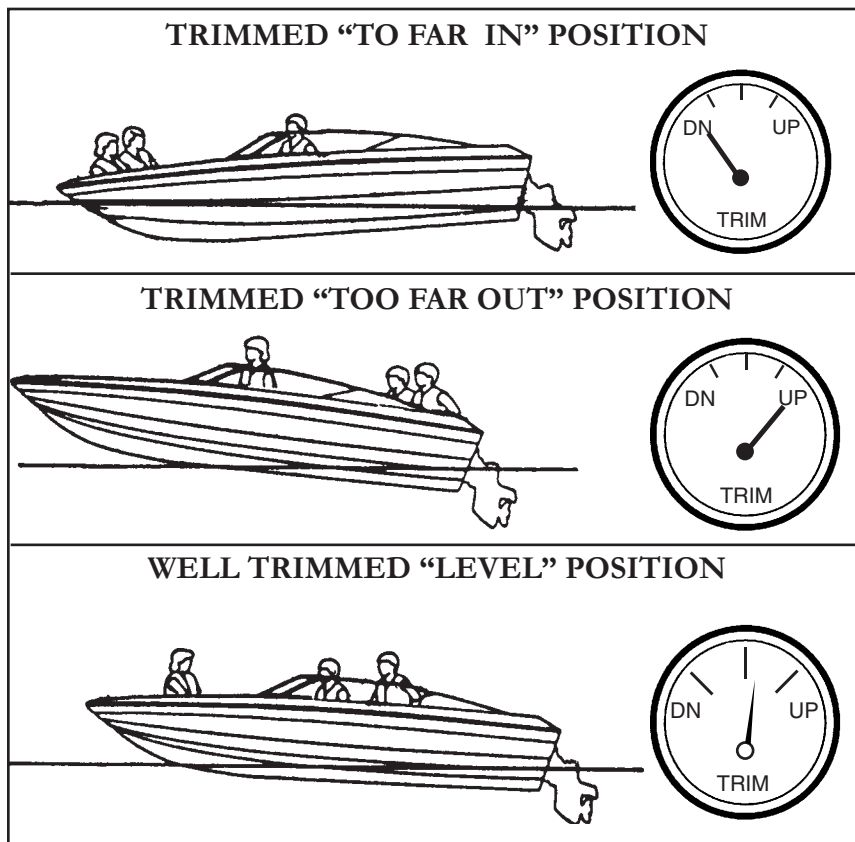

### CAUTION

DO NOT RUN ENGINE ABOVE 1000 RPM  
WITH THE STERN DRIVE TRIMMED  
FOR SHALLOW WATER MANEUVERING SINCE THE  
STERN DRIVE IS OUT BEYOND THE GIMBAL RING  
SIDE SUPPORT BRACKETS.  
OPERATING IN ABOVE MANNER COULD PRODUCE  
A DANGEROUS STEERING CONDITION OR COULD  
DAMAGE THE STERN DRIVE COMPONENTS.





### ANCHORING



Selecting the correct anchor is an important decision. The anchor style in part depends on the usage and boat type. Regal usually designate an anchor type for each boat model. Some models incorporate line or chain with an optional windlass. For the 2800 a “claw” type anchor is recommended as it is compatible with most bottoms. Anchoring is easier with another person on board. First be certain that the line for the anchor is properly attached, to avoid losing the anchor and anchor line overboard. For most anchors to perform more efficiently, you should attach 3 to 6 feet of chain. The chain will stand up to the abrasion of sand, rock, or mud on the bottom much better than a nylon line. It should be galvanized to reduce corrosion. Next, attach a length of nylon line to the other end of the chain.

The nylon will stretch under a heavy strain cushioning the impact of waves or wind on both the boat and the anchor.

To anchor, select a well protected area, preferably with a flat bottom. Contrary to modern belief, you do not throw the anchor over while the boat is making headway, or moving forward. In fact, the bow of the boat should be brought slowly backward, while easing the anchor slowly over the front of the boat until it hits the bottom. To “snub the line” means to stop its outward “pay” or movement. **Usually the length of anchor line used should be 5 to 10 times the depth of the water.** After you have anchored, check your position with landmarks if possible. You need to continue to monitor these landmarks to make sure you are not drifting. Since anchoring can also be an emergency procedure, the anchor and line should be readily accessible.

For increased holding power in windy conditions, two anchors are sometimes set. If your primary anchor drags, you can run out your secondary anchor without picking up the primary one. The important thing is to lay them out at an angle. When setting two anchors, make sure they are fastened to separate rodes or cleats. This is done in case you need to adjust one later so the line is accessible.



## CHAPTER 5

---

If two anchors are used ahead of a boat, make sure to set the rodes at an angle than in a straight line to reduce the chances of tangling as the boat moves in wind and current. See the above illustration.

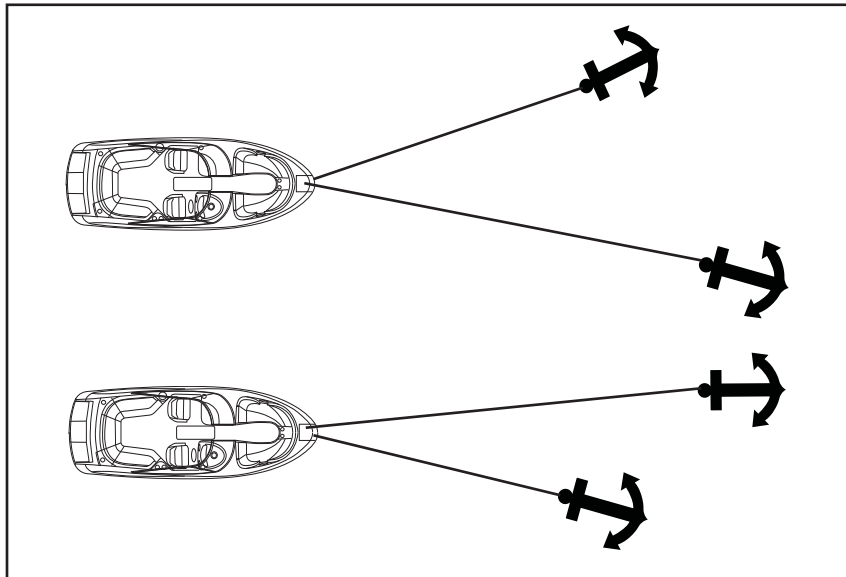

## TOWING

In case you find yourself aground or in need of a tow, or should you want to tow another vessel, keep in mind that you **never use deck hardware or cleats to secure lines for towing!**

Deck hardware is intended for mooring and anchoring, and is not designed to withstand the strain and pull of towing. Rather than tie the line to your cleats on deck, it is suggested that you tie a bridle by passing a line completely around the hull of your boat to avoid damage.

When towing, always stand clear of a taut line, as any type of line breaking under stress can be extremely dangerous. The preferred line for towing is double-braided nylon, as it has sufficient elasticity to cushion shock loads. Move slowly and cautiously.



### **Law Of Salvage**

---

The Admiralty law sometimes referred to as the salvage law was founded primarily on English law fundamentals and basically says that a vessel distressed, in danger of flounder, if rendered assistance from a towing company or private agency, can be forced to relinquish a portion of the vessels' worth for the assistance received.

### **NOTICE**

IN THE EVENT YOUR VESSEL IS IN DISTRESS,  
PRIOR TO ALLOWING ANY TOWING COMPANY OR  
PRIVATE AGENCY THE RIGHT TO PASS A LINE TO  
YOUR VESSEL, BE SURE TO ESTABLISH THAT YOU  
DO NOT AGREE TO ANY SALVAGE RIGHTS.  
ESTABLISH WITH THE CAPTAIN OR OPERATOR  
THAT YOU WISH TO BE ASSISTED IN A CONTRACT  
BASIS AND ESTABLISH A PRICE.  
OF COURSE IN CERTAIN SITUATIONS, YOU MAY  
NOT HAVE THIS OPTION.

**USE YOUR BEST JUDGEMENT!**



## CHAPTER 5



### DANGER

AVOID DEATH OR SERIOUS BODILY INJURY!  
DO NOT USE DECK HARDWARE INCLUDING  
CLEATS FOR TOWING.

### Knots

Knots are useful in docking, towing and other emergency situations. Learning to tie knots requires practice. As they say “Practice makes perfect”. Some of the knots used in boating are the square, bowline, anchor bend, clove hitch, figure eight and half hitch. There are several periodicals available that explain various knots and how to tie them effectively. An experienced skipper will know the basic nautical knots and will use them when on the water. Take the time to learn how to tie the basic knots.

**Figure 8 Knot  
Tied To Cleat**



A useful knot to learn for general docking is the figure eight with one end reversed. By turning the free end of the line back under, the knot can be released without disturbing the boat. After some practice one person can secure a vessel easily to a dock or pier in a variety of weather conditions. This knot normally is used to tie the bow and stern. Then the vessel can further be fastened by tying the spring line in the figure eight knot. Wrap it around the cleat 2 or 3 times.



### EMERGENCIES

Always be ready to help others on the water if possible, but do not take any unnecessary risks. Use equipment to save a life, but do not risk a life to save equipment. Consult earlier information in this manual concerning accidents, etc. Also, read other literature concerning on the water emergencies. Be alert and prepared!

#### Fire

---

Fire aboard a vessel can spread quickly and can cause tremendous alarm among everyone. Most fires can be prevented by keeping the bilge free from oil and debris. Keep all equipment stowed and maintained in working order. Carry a backup fire extinguisher on board. If something becomes a possible fire hazard, remove that possibility at once.

Never use water on gasoline, oil or electrical fires. When you dump water on an electrical fire a you can be shocked since water conducts electricity.

Follow these instructions if a fire breaks out:

- A. Fit everyone aboard with a life jacket. Turn off the ignition.
- B. Try to keep the fire downwind. If the fire is to the stern, head the bow toward the wind. If forward, put the stern to the wind.
- C. If the engine should catch fire, shut off the fuel supply. Usually there is a fuel tank access that you can crimp the fuel feed line.
- D. Use a hand fire extinguisher. Make sure to point it at the base of the flames. Use short bursts and sweep the extinguisher side to side.

**Remember : (4 lb. extinguisher discharges in 20 seconds)**

These actions help prevent the fire from spreading to other parts of the boat. You can extinguish fires quickly if you act swiftly. Have a plan of action in motion in case a fire breaks out.



## CHAPTER 5

---

### FIRST AID

Knowing first aid can save lives. A first aid kit and the ability to use it are important ingredients for the safety of a skipper's passengers, crew and vessel. Having confidence and competence in handling medical emergencies on board is a must for the skipper. Invest your time in a first aid course available at the American Red Cross.

### CPR (Basic Life Support)

---

If someone is seriously injured have someone call for help while the injured person is being attended.

Check for possible danger signs; loss of breathing, unconsciousness, severe bleeding and heartbeat. If you determine the individual is not breathing or unconscious place the victim on their back on a hard surface and do the following:

1. If unconscious, open the airway. Neck lift, head lift or chin head lift.
2. If not breathing, begin artificial breathing. Pinch the nose. Give 4 quick breaths. If airway is blocked, try back blows, abdominal or chest thrusts and finger probe until airway is open.
3. Check for pulse. Begin artificial circulation. Depress sternum 2". 15 compressions rate 80 per minute. 2 quick breaths. Continue uninterrupted until advanced medical support is available.

**Follow up immediately with medical authorities!**



### **HYPOTHERMIA**

Hypothermia is a condition where the body temperature decreases because the body can't generate enough heat to maintain its normal temperature. It can be serious and usually occurs where victims have been immersed in water (under 68 degrees) for extended periods of time. If you encounter a possible hypothermia victim call for help on the radio and get the person out of the water.

Symptoms are:

1. Shivering that if condition is advanced may stop.
2. Confusion, clumsiness or slurred speech.
3. Rigid muscles.
4. Semiconscious to unconscious.

#### **Treatment:**

- Remove wet clothing.
- Monitor the victim's pulse and breathing.
- Rapidly apply heat to the body core by using blankets, naked bodies or warm water.
- Do not give the person any food or drink.
- Do not warm the arms and legs. Warming of these extremities can be fatal.

**Follow up immediately with medical authorities!**



## CHAPTER 5

---

### ENVIRONMENTAL AWARENESS

There are numerous vessels operating on our waterways on a daily basis. Each boat has an impact on our environment. Boat operation habits, marine sanitation, and maintenance all play a role in a delicate battle to keep the ecosystem clean. Each of us has a role in doing our part as an environmentally conscious skipper to conserve our waterways.

The National Marine Manufacturer's Association lists their top ten of Eco-Boating Practices as follows:

1. Observe all regulatory agency policies regarding marine toilets.
2. If equipped with a holding tank, use marina pump-out facilities.
3. If used, make sure bottom paints are legal and ecosystem friendly.
4. Use only biodegradable cleaning agents.
5. Dispose of all garbage and litter on shore properly, not on the water.
6. Don't top off fuel tanks. Leave expansion room. Clean up spills.
7. Watch your wake and propeller wash.
8. Make sure your engines are well tuned and maintained.
9. Control your bilge water.
10. When fishing, practice the "catch and release" principle.

Follow these basic practices when on the waterways. Treat the environment in a way that you would like to be treated.





# Equipment Operation

## INTRODUCTION



*A portion of the Regal boat illustrations in this owner's manual may represent typical examples.*

This chapter assists the operator in understanding typical standard and selected optional equipment which may be featured on your vessel. *A portion of the equipment described may not be installed on your boat or the pictorials may not exactly match your*

Regal is constantly improving its product line and therefore may make changes in vendors, parts and specifications at any time without notice.

**For further equipment information, refer to the individual vendor literature provided in the owner's packet.**

**Read and understand all equipment information before attempting to use the components.**

## CHAPTER 6

---

### Air Compressor ---



If installed the air compressor/inflater provides 12 volt blower capacity for various aquatic toys, etc. To use, remove the unit from its stand (if provided) and insert the cord plug into the 12 volt accessory receptacle located at the ignition panel. Activate the inflater.

On select versions there are attachments to fit various water sport component fittings. After use return the compressor to its stand (if furnished with one).



# Equipment Operation

## Anchor Windlass

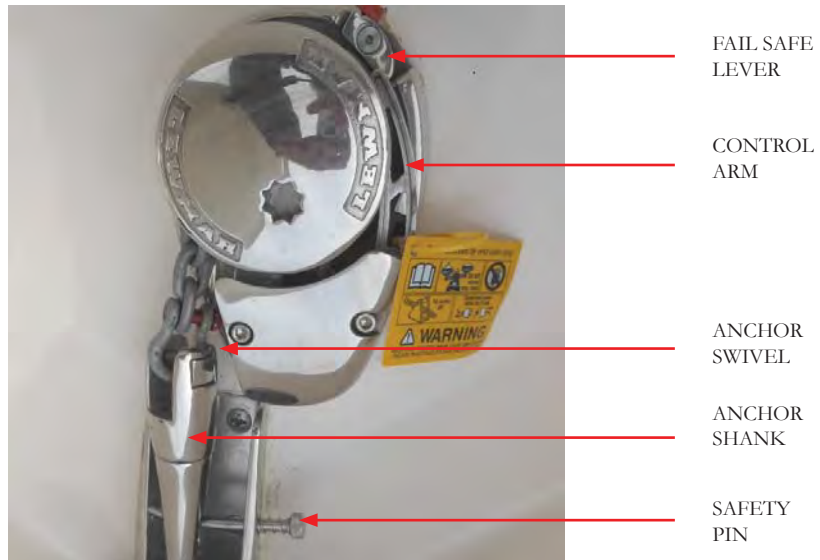
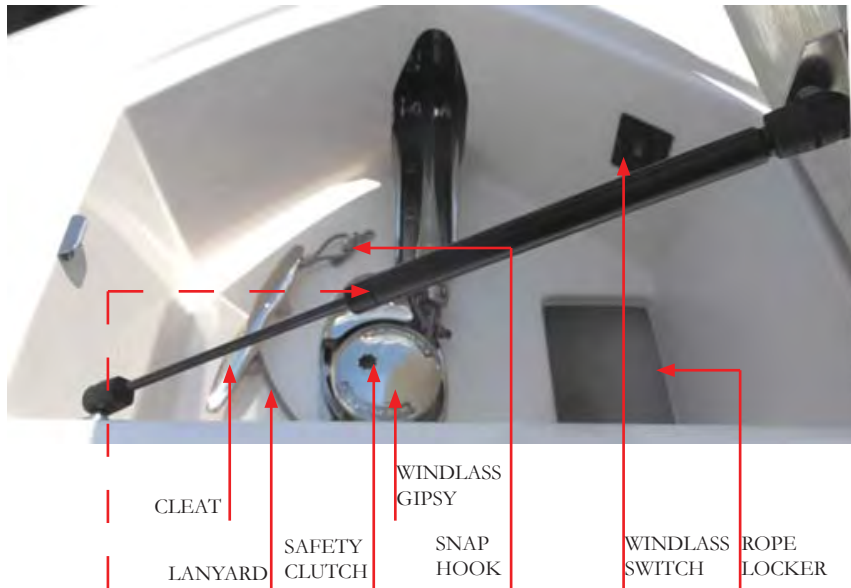



## CHAPTER 6

---

### Overview

If installed the windlass features a stainless steel polished “claw” style anchor complete with swivel. This anchor has high holding power in most seabeds.

A momentary windlass rocker switch located at the anchor locker controls the lowering and retrieving of the anchor through the windlass. A 50 amp breaker for windlass overcurrent protection is located at the battery management panel (See illustration in this chapter).

There is a lanyard with a snap hook to add holding power when the anchor is in the stored position.

The cleat is for tying off the anchor rode rather than maintaining constant pressure on the windlass itself.

Note: Never use the windlass to break the anchor free from the bottom. This may cause excessive strain on the windlass motor and or hardware.



### WARNING

AVOID SERIOUS INJURY!  
ENSURE THAT ALL BODY PARTS AND CLOTHING  
ARE KEPT CLEAR OF THE ANCHOR RODE  
AND WINDLASS DURING OPERATION.



### WARNING

AVOID SERIOUS INJURY!  
DO NOT “PAY OUT” THE ANCHOR UNTIL IT IS  
DETERMINED THAT THERE ARE NO SWIMMERS  
OR DIVERS NEAR THE AREA.



## Equipment Operation

---

### Windlass Operation- Introduction

The windlass normally comes outfitted with a rode using 100' of 1/2" nylon rope along with 10' of galvanized chain. The chain is connected to the anchor shank which is next to the anchor. The chain acts as a safety margin to protect the rope rode from being damaged by sharp seabed objects such as coral that might sever the rope if it was next to the anchor. If needed for harsh sea bottoms the rode can be converted over to 100' of 6 mm galvanized chain with a small length of rope at the top for tying off the rode to a cleat.

The safety clutch is used to “pay out the windlass chain or to retrieve the anchor “rode”. There is a handle in the anchor locker that inserts into the gypsy drive cap located on top of the windlass framework.

With the handle inserted in the cap, turn the handle *clockwise* which grips the “gypsy”, locks it and **tightens the clutch**. Remove the handle and store it after usage.

To **loosen the clutch** with the handle inserted in the cap, turn the handle *counterclockwise* which will free up the “gypsy” from the drive train. Remove the handle and store it.

Before attempting to “pay out” the anchor **ensure that the fail safe pawl is disengaged from the gypsy and held clear of it by the fail safe lever**. See windlass owner’s manual for further information.

**Be sure to pull the safety pin from the anchor shank before using the system.** *The anchor will not pay out with this pin inserted.* This pin should be reinstalled after each anchor retrieval.



## CHAPTER 6

---

### **Paying Out Anchor Using Gravity**

To let out the anchor release any anchor locks, insert the clutch handle into the gipsy drive cap and turn it in a clockwise direction to tighten the clutch. When in a safe mode, pull back on the clutch until the anchor and rode begin to pay out. Control the rate of anchor descent by pushing the clutch lever forward. When the desired rode is paid out, tighten the gipsy drive cap.

### **Paying Out Anchor Using Power**

Make sure any anchor locks are disengaged and the pin through the anchor shank is pulled along with the lanyard hook. Stand clear of all windlass components when paying out.

Using the windlass momentary switch, press and hold the lower portion of the switch. When the proper ratio of anchor rode is paid out disengage the switch and tie off the rode to a cleat since it is not recommended to let the windlass mechanism be the only source holding the rode to the anchor on the sea bottom. Also, do not use the fail safe pawl to hold the anchor load as windlass damage could occur.

### **Hauling In Anchor- Manual Recovery**

Insert clutch handle into the gipsy drive cap and turn clockwise until anchor is fully returned to the bow roller.

### **Hauling In Anchor Using Power**

When anchor rode is safe to haul in use the windlass momentary switch to haul in the anchor rode. Press and hold the upper portion of the switch until the anchor is returned to the bow roller position.

The fail safe pawl does not need to be disengaged during retrieval as it will act as a ratchet. When the anchor has been retrieved in the bow roller position the fail safe pawl should be left engaged in the gipsy to prevent accidental activation of the windlass while underway.



## *Equipment Operation*

---

Also, reinstall the pin through the anchor shank and the lanyard hook. Note that the fail safe pawl does not need to be disengaged from the gipsy before the anchor can be paid out again.

### **Windlass Safety Tips**

1. Read the windlass owner's manual.
2. Keep all body parts and clothing away from an activated windlass.
3. Do not exceed the maximum load designated by specifications.
4. Always tie off the anchor rode to the designated cleat.
5. Do not use the windlass to pull or tow another vessel.
6. Always shut off windlass breaker or main battery switch before servicing the component.
7. Always use engine power to gain headway before retrieving anchor.
8. Always look for swimmers or divers before deploying anchor.
9. Always secure rode/anchor while cruising or pulling vessel on highway.
10. Use authorized vendor replacement parts only.
11. Contact your closest Regal dealer for technical information or servicing.



## CHAPTER 6

---

### Windlass Operating Tips

It is recommended that during the paying out process the engine be run to stern before full scope is reached. This will help prevent the rode from being tangled in the anchor on the sea bottom.

It is recommended that during the retrieval process use the engine to gather headway. Do not let the vessel sit directly on top or over the area where the anchor lies because the chain rode could damage the hull topside.

As the anchor raises toward the scuff plate area, retrieve the last few feet very carefully to eliminate any hull damage.

Once the anchor is retrieved, check to ensure the fail safe pawl is engaged in the gipsy which will help prevent accidental activation.





## Equipment Operation

---

### Automatic Fire Extinguisher

---



Typical Automatic Fire Extinguisher  
Canister Location

If installed, the automatic fire extinguishing system is located in the engine room. See the illustration. The system uses an environmentally friendly agent FE-241 which has been approved by the EPA to replace the old Halon agent. This

system is formulated only for use in the engine compartment of your vessel. FE-241 is specified for gasoline fuel systems only.

#### Operation-Automatic

Automatic fire extinguisher systems are not nor are they intended to be explosion suppression devices. **Boat owners still need to take normal precautions for checking gasoline fumes and using blowers.**

Read the information regarding the dash and manual operation portions of the fire extinguisher system. When the system actuation starts you may hear a loud sound similar to that of small arms fire, followed by a rushing air sound.



## CHAPTER 6

---



The system will show actuation whenever the ignition key is ON and the indicator light is OFF. The actuation time when a fire occurs is dependent on the severity of the fire.

When the automatic fire extinguisher activates **IMMEDIATELY SHUT DOWN ALL ENGINES, POWERED VENTILATION (BLOWER), ELECTRICAL SYSTEMS AND EXTINGUISH ALL SMOKING MATERIALS. DO NOT OPEN THE ENGINE COMPARTMENT IMMEDIATELY.**

Allow the agent to “soak” the compartment for a period of time and wait for hot metals and any fuels to cool before inspecting for the fire cause. Premature opening of the engine compartment allows an in-rushing of oxygen and could result in a flash-back. When the engine compartment is opened have portable fire extinguishers ready.

	<b>WARNING</b>
<b>AVOID SERIOUS INJURY OR DEATH! DO NOT BREATHE FUMES OR VAPORS CAUSED BY A FIRE AS THEY ARE HAZARDOUS AND TOXIC.</b>	

KEEP ADDITIONAL MARINE APPROVED HAND HELD FIRE EXTINGUISHERS ON BOARD AS BACKUPS. THESE UNITS SHOULD BE SERVICED PERIODICALLY BY LOCAL FIRE EXTINGUISHER COMPANIES.



## Equipment Operation

### Operation-Manual

If a fire has started in the engine compartment where the automatic fire extinguisher system is located, do not wait for automatic activation. Release the system manually. Close any opened hatches, shut down all

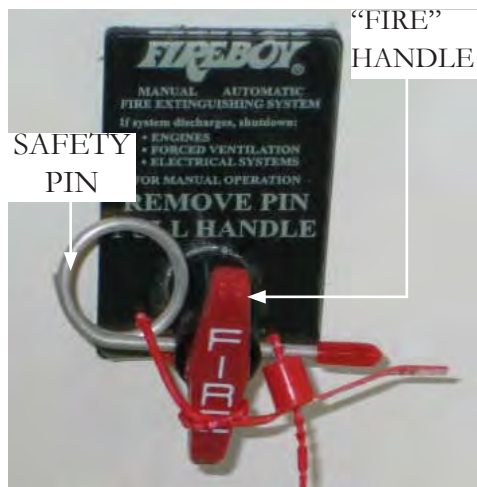

forced ventilation devices, engines, and electrical components.

Remove the safety pin from the “Fire” T-handle, and pull firmly on the “FIRE” cable handle which will activate the fire extinguisher unit in the engine compartment. A loud “rushing” or air” sound may be heard. Complete discharge will take several seconds. Do not open the compartment immediately!

Keep the compartment closed for a period of time sufficient to allow the agent to soak all areas of the protected space. This allows hot metals and fuel to cool. The manual release system is located in cockpit.

**Locate and learn how to use it!**

	<b>WARNING</b>
<p>AVOID SERIOUS INJURY! ACCIDENTAL DISCHARGE COULD OCCUR DURING HANDLING, INSPECTION, OR WORKING IN THE ENGINE COMPARTMENT. WEAR EYE PROTECTION AT ALL TIMES!</p>	



## CHAPTER 6

---

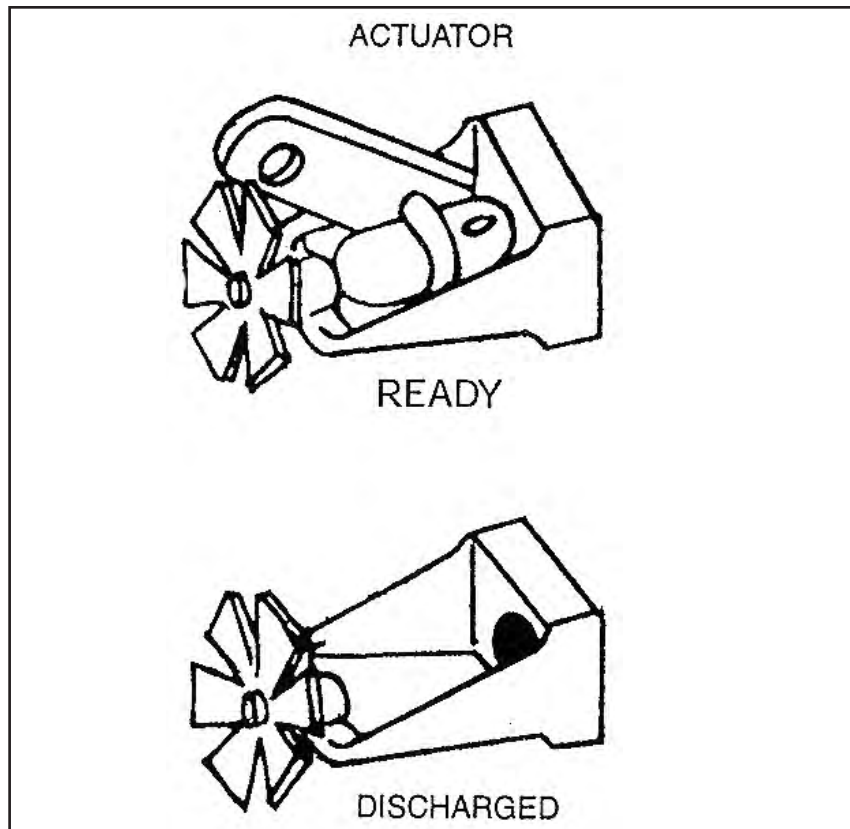

Premature opening of the compartment could cause a re-flash. When opening the engine compartment for inspection have hand held portable extinguishers ready.

Inspect the pressure gauge and system before and after each outing. Refer to the maintenance chapter for caring for your fire extinguisher system.

The illustration above shows the actuator not discharged at the top and one which has been discharged at the bottom.



## Equipment Operation

---

### Battery

---



Optional engine batteries are the heartbeat of the on-board DC (direct current) electrical system. They supply the power to crank over the engines and to operate the electrical equipment through the engine charging system. When purchasing batteries one group 24 wet cell type is specified for the engine cranking circuit. Also, one group 31 wet cell type is specified for the house battery.

The battery hardware features a red boot to protect the positive terminal and a battery tray with hold downs. Make sure the red (positive) boot is completely covering the positive terminal of the battery. The negative (ground) terminal does not require a protective boot. The terminal nuts should be checked periodically for tightness and corrosion. In colder climates battery removal for the winter months is to be considered. Trickle charge as needed placing battery on wood in a well ventilated area free from any gas or propane appliances.

Contact your closest Regal dealer for further battery information and service schedules.



## CHAPTER 6

---

### Battery Charger

---



#### Overview

An optional 20 amp battery charger may be installed on your vessel. It features digital microprocessor charging technology, 15 amp grounded receptacle and a galvanic isolator. Other features include digital bank trouble indicators, monthly storage reconditioning mode and digital LED display (LED's for operation status and trouble-shooting). Use the battery charging system at dockside by plugging in an approved extension cord as indicated in the next page warning. The available current will be able to support on board components such as cockpit refrigerator, stereo system, cockpit heater along with any electronics including gaming devices.

#### Role Of Galvanic Isolator

If installed on your vessel the galvanic isolator is 30 amps. Technically speaking the galvanic isolator blocks DC current flow on your AC shore power grounding conductor (in the case of the 2800 it would involve the green ground wire/blade on a 3 prong plugged in extension cord). The system minimizes the possibility of electrocution. As soon as this extension cord circuit is activated it is also connected to the dock and all the other boats around you. Your boat is now part of a larger electrical system (Galvanic cell).



## *Equipment Operation*

---

Bottom line is that the zinc anodes on your vessel and drive may erode at a much faster rate due to stray current in the water. Zinc is more sacrificial than many other metals used on boats such as stainless steel.

At the end of the day, you want your underwater metals protected, and you want your zincs to erode at a predictable rate for ease of maintenance.

With the galvanic isolator installed as part of your battery charger option, it effectively isolates your boat from others around you (blocking any damaging DC flow) while still maintaining the integrity of the shore power safety ground (extension cord plugged into dockside). The galvanic is the best way to prevent damage to vital metal parts on your vessel.



## CHAPTER 6

---

Read and understand the following warning before using the battery charger system.



### WARNING

AVOID SERIOUS INJURY OR DEATH  
FROM FIRE, EXPLOSION OR ELECTRICAL SHOCK!

THE BATTERY CHARGER SHALL BE CONNECTED  
WITH AN APPROVED 14 GAUGE GROUNDED  
EXTENSION CORD TO A GROUND FAULT CIRCUIT  
INTERRUPT (GFCI) PROTECTED AC OUTLET.

CONNECT EXTENSION CORD TO BOAT  
15 AMP FEMALE PLUG BEFORE CONNECTING  
TO THE GFCI PROTECTED AC OUTLET.

MAKE CONNECTION IN AN OPEN ATMOSPHERE  
FREE OF EXPLOSIVE FUMES.

MAKE ALL CORD CONNECTIONS SECURELY  
WITH STRAIN RELIEF  
AND AVOID ANY CORD-WATER CONTACT.





## Equipment Operation

---

### Digital Display Center Operation

When the battery charger is activated the following icons may appear on the charger display:

1. The blue LED icon illuminates when power is initially connected.
2. The red battery type LED will illuminate for wet-cell batteries.
3. The green LED will illuminate indicating the self test and system analysis was successful. This may take several minutes to complete.
4. The charge mode LED will illuminate for the following functions:
  - a. Charging- Red LED will flash during the self test (several minutes) and will stay solid red during the charging cycle.
  - b. Conditioning- Amber LED illuminates during this mode.
  - c. Ready/Maintain- Green LED illuminates when system batteries are fully charged.
  - d. Storage Recondition: Green LED fades back and forth when conducting the once a month recondition mode. This would be beneficial when in storage or at dockside for extended periods. Never leave the extension cord engaged without proper ventilation since explosive hydrogen gases will develop during the battery charging process. This may apply to inside storage or moorings with the canvas installed.
  - e. Troubleshooting LED's- A red LED illuminates indicating a problem with a system battery, DC connections, blown fuse, or AC system connections.

For further information refer to the maintenance or troubleshooting section of this manual along with the vendors information in the owner's information packet.



## CHAPTER 6

---

The battery charger option features a 15 amp female plug mounted in the cockpit (see illustration). When outfitted with an approved extension cord the system assists in charging both the



house and cranking system batteries through the battery management panel.

The battery charger features a 20 amp capacity and is of the self-limiting type. A dedicated bank exists for each battery along with over current protection for each bank at the battery management panel. The SCR discussed in the following pages and located on the battery management panel assists in regulating the battery charging process.

Note: The battery switches located on the battery management panel do not need to be in the “on” position for the system to charge the system.

To activate the battery charger do the following:



1. At dockside locate a grounded 3 prong straight bladed female marina outlet for plugging into an extension cord. Use this outlet to test the dockside wiring circuit before plugging in an extension cord.

2. Using a circuit tester (available at most box stores) check to ensure the dockside GFCI or GFCI protected outlet has correct polarity as reverse polarity will “blow” the internal battery charger fuse.

3. Contact appropriate marina personnel if the tester does not show correct polarity. Normally the tester will display a specific set of icon lights for correct current flow and grounding. Look for icon configurations which point to hot and ground wires reversed or a circuit ungrounded. Also, the icons could indicate the neutral and hot wires reversed. Refer to the specific tester for its icon definitions. They are usually stamped on the top of the tester. Again, contact appropriate personnel as needed to correct any deviations from the normal test results before plugging into a dockside outlet.



## Equipment Operation

---

4. After the outlet is determined to be wired correctly proceed by doing the following operations:

a. Plug in a 14 gauge grounded extension cord first into the cockpit female plug.

b. Next, plug the female end of the extension cord into the marina outlet. These cords are available in multiple lengths but we recommend that you limit the cord length to 25 or 50 feet to meet the normal 7 amp current draw.

At this point the system should start to charge the batteries as needed.

**Do not use higher gauge extension cords as it is possible that the amperage (current draw) will increase because of the reduced wire gauge size.**

**Do not use extension cords longer than 50 feet since voltage drop levels could increase.**

c. Make sure the extension cord does not lay in the water, is not frayed and features a working ground prong.

d. When outfitting for cruising roll up the extension cord and store it in a dry area. Also, close the female outlet cover. This will protect the female plug from spray and salt deposits if in a salt water environment.



## CHAPTER 6

### Battery Management Panel



Your vessel features a battery management panel located at the starboard cockpit area. This battery management panel includes an “on” and “off” position battery switch. *This battery switch controls both the house and engine cranking battery.*

The **starboard** battery controls the house circuits and is known as the **“house”** battery. The **port** battery is known as the **engine cranking battery**.

*The battery switch controls both batteries.* The battery switch can be switched to “combine batteries” which will permit cranking both the house and engine batteries simultaneously. This can be useful if one of the batteries is discharged.

Notice the four breakers at the upper right side of the panel. These breakers protect standard and optional main circuits including the cabin main (protects the head breaker panel), helm (protects dash wiring), windlass (protects circuit wiring), and amplifier (protects the amp used on the SPP package only).

Also, there are additional equipment breakers at the bottom of the panel. Note that only select (marked) breakers are used with this vessel.

Battery Charger- protects one of the battery charger circuit legs.

Aft Bilge Pump- protects the automatic float switch only.



## Equipment Operation

---

Shower Pump- protects the head shower sump pump.

Stereo Mem- Protects the stereo memory circuit should the battery circuit be interrupted. Select stations and mode adjustments will remain constant.

CO Monitor- Not currently used with this model.

Battery Charger- Protects one of the battery charger legs.

Fwd Bilge Pump- Protects the automatic float switch portion only of the forward bilge pump.

Note: **Never** turn off the battery switch with the engine running as damage to the engine charging circuit will occur.

When leaving the vessel for extended periods of time it is recommended to deactivate the battery switch. With the battery switch in the “off” position, *the automatic bilge pump and stereo memory remain energized.*

**Note: Should a breaker “pop” or fuse “blow” determine the cause of the problem before resetting the breaker or replacing the fuse. When replacing breakers and fuses use the correct type and amperage.**

Refer to the technical drawing section of Chapter 12 for breaker size information along with an aft panel view showing the management panel wiring circuit. This information can be useful for troubleshooting.



## CHAPTER 6

---

### Digital Voltage Sensitive Relay (DVSR)



Note the DVSR located next to the battery switch in the center of the battery management panel. The purpose of the DVSR is to protect the battery circuit from being discharged. Also, when the engine battery is fully charged it can send current to the house battery.

Note that at *mooring* when activated the battery charger sends current to the appropriate battery “on demand” and the DVSR’s are more or less idle. At *sea*, the DVSR system sends needed battery current via the engine alternator charging circuit to the appropriate battery.

When the engine cranking battery rises above 13.7 volts DC the DVSR switches to charge (cranking and house) both batteries simultaneously. If battery voltage drops to 12.8 volts DC the DVSR disengages.

This DVSR capability is known as “dual sense” technology. It permits the DVSR to sense the voltage of all batteries that the unit is connected between. If one of the batteries is receiving a charge the DVSR will close by paralleling both battery banks to charge the house battery along with the engine cranking battery.

If the DVSR senses the engine battery is being discharged at a fast rate it will open and will not allow that battery to be overly discharged to the point that the engine will not crank.

An example of the above situation would be if the vessel was stationary at sea for an extended period with various electronic and entertainment equipment components energized along with the engine off the battery(ies) will discharge.



## *Equipment Operation*

---

The DVSR uses a LED type light that indicates that the DVSR is closed and is sending a charging current to the batteries.

If the LED light stays on after the engine is turned off do not panic. This is a normal condition. The residual battery voltage due to battery charging has not yet dropped below 12.8 volts for the DVSR to cut out.



## CHAPTER 6

---

### Bilge Pump/Automatic Float Switch

---

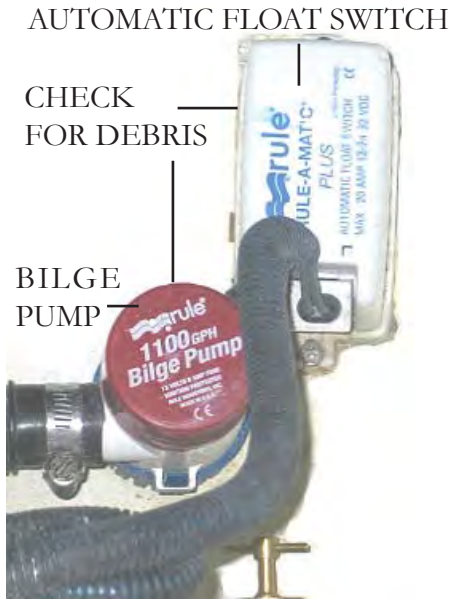

Before each outing check the operation of the bilge pump and automatic switch. With the dash switch in the automatic position manually pick up the automatic switch. The automatic switch should energize the bilge pump. Another approach to check operation would be to fill a 5 gallon bucket with water and pour it into the aft bilge.

The pump should begin the activation cycle and water should be exiting the starboard thru-hull.

Periodically, check for debris

around the grates of bilge pump base. The bilge pump and automatic switch are located in the bilge (sump) in front of the engine.





## Equipment Operation

---

### Blower

---



The blower's function is to evacuate any fumes and engine exhaust gases that have accumulated in the lower bilge. The blower must be activated at least 4 minutes prior to starting the engine. Check the ventilation ducts and black bilge hose to ensure they are not obstructed.

Be careful not to step on the bilge hoses when performing sump maintenance. The blower should be used below cruising speeds. The blower is located in the sump.

Read and understand the following warning:

	<b>WARNING</b>
GASOLINE VAPORS CAN EXPLODE. BEFORE STARTING ENGINE, OPERATE BLOWER 4 MINUTES AND CHECK ENGINE COMPARTMENT FOR GASOLINE LEAKS OR VAPORS. RUN BLOWER BELOW CRUSING SPEED.	



## CHAPTER 6

---

### Board Racks

---



Optional board racks attach to the Power Tower. Pull up on the latch to move the board rack body. It will reach a detent and lock. Use the bungee cord to hold the boards in the slots.



## *Equipment Operation*

---

### **Bow Filler Cushion**

---



Simply place the starboard filler cushion in place to extend the starboard seat. Be sure to store the cushion in a dry area and away from objects that may cause abrasion to the cushion while cruising.



## CHAPTER 6

---

### Bow Scuff Plate

---



Your vessel features a stainless steel bow scuff plate. This stainless steel plate protects the fiberglass bow area from scuffing. The innovative design helps protect the boat bow when retrieving the anchor in rough seas or foul weather conditions. Always retrieve at a slower rate using

the windlass momentary switch to help guide the anchor shank into the bow roller and chute. After each cruise especially in salt environments wash down all windlass parts and the scrape plate with fresh water.



## Equipment Operation

---

### Bow Thruster

---



#### General Safety Notices:

1. Be sure to read and understand the safety information and all thruster operation information before attempting to use the thruster system.
2. Do not operate the bow thruster system close to swimmers as a high powered suction is produced at the propellers.
3. Make sure the propeller lock nut is torqued to the required foot pound specification.

#### Using The Thruster:

To use the thruster first make sure the battery switch is activated.

As part of the thruster system there is a joystick on the helm. The thruster will assist in slow speed maneuvering especially around a dock or close mooring situations. It operates similar to an gaming or marine engine joystick.

To activate the joystick, push and hold the black button. The red icon will illuminate.

Never run the thruster dry; it will weld the relay contacts as it becomes a generator in spool down.

Do not make quick changes from one direction to the other direction, or it will damage the unit.

The minimum running voltage for the thruster is 10.5 volts; therefore the main engine should be running to maintain this voltage requirement. There is an in-line ANL fast activation fuse for overcurrent protection behind the thruster switch panel.

For further information refer to the thruster operator's manual in the owner's information packet.



## CHAPTER 6

---

### Bow Walk-Through Doors

---



Walk-through bow doors are great in foul weather. With the tonneau (bow) cover in place, simply open the doors and pull across the bow opening. Secure shut. Close the tonneau cover.

To store, fold against the walk-thru and secure the folding latch. Note there is a starboard side storage drawer along with a hide-away trash receptacle. Periodically wipe

the plexiglas doors with fresh soapy water and rinse dry. Do not use any harsh chemicals such as cleanser or ammonia based products on the doors as damage will occur.



## Equipment Operation

### Breaker Panels

There is a breaker panel located at the helm area. Become familiar with the components that this panel protects. Should a breaker “pop” find the cause of the problem before resetting the breaker. Push in on the breaker to reset it.

Select breakers may not be found on your vessel since that option may of not been installed. See the technical drawing chapter for specific breaker sizes.



UNDER HELM BREAKER PANEL

Cockpit Lts- Protects the LED style light system.

Anchor Lt- Protects the power tower 360 degree illuminated light.

Nav Lts- Protects the bow navigation lights.

Bilge Pump- Protects manual side of bilge pump not the auto float.

Blower- Protects the bilge blower circuit.



## CHAPTER 6

---

Horn- Protects the horn mounted at the starboard hull.

Wiper- Protects the optional driver side windshield wiper circuit.

Docking Lts- Protects the optional bow mounted docking lights.

Exhaust- Not currently used on this model.

Tower Lts- Protects the power tower overhead lights.

Under Wtr Lts- Protects the optional transom mounted underwater lights.

Hatch Lift- Protects the engine hatch actuator.

Murphy- Protects the RegalVue display.

12 V Recept- Protects the helm mounted 12 volt accessory receptacle.

Trim Tabs- Protects the transom mounted trim tab system.

Windlass- Protects the control actuator wires- forward & reverse.

Halon Indicator- Protects the dash mounted fire extinguisher indicator.

Cockpit Heater- Protects the cockpit heater coil circuitry from overload.

Fridge- Protects the optional refrigerator located at the passenger seat.

Hyd. Step- Protects the optional hydraulic step circuit located at the swim platform.

Stbd Seat U/D- Protects the up/down helm seat circuitry.

Stbd Seat F/A- Protects the forward/aft helm seat circuitry.





## *Equipment Operation*

---

Accy 1- Protects the accessory switch circuitry. This breaker is used for customer after-market components. Make sure the breaker size is correct for the equipment being installed.

Accy 2- Protects the accessory switch circuitry. This breaker is used for customer after-market components. Make sure the breaker size is correct for the equipment being installed.

An additional breaker panel is located at the battery management panel. Many of the main electrical circuits are protected here. Know the procedure for resetting the main breakers located on this panel. See the battery management panel in this chapter for additional information.



## CHAPTER 6

---



An auxiliary 12 volt breaker panel is located in the head. Below is an explanation of selected breakers.

12 VDC Receptacle- Protects the dash accessory receptacle.

Compartment Lights- Protects the head light and the light beneath the helm area.

Grey Water- Protects the grey water sump pump circuitry.

Macerator- Protects the optional overboard discharge pump.

Head- Protects optional electric head.

Water Pump- Protects the fresh water pump.

Television- Not currently used on this model.

Level Monitor- Protects the optional monitor panel.



## *Equipment Operation*

---

Stereo- Protects the Fusion stereo system.

Vent- Not currently used on this model.



## CHAPTER 6

---

### Canvas

---

#### BIMINI TOP INSTALLATION



REMOVE AND STORE BOOT IN A DRY LOCATION.

FAMILIARIZE YOURSELF WITH THE PARTS ON THE FOLLOWING PAGE AS THEY ARE REFERRED TO IN THE INSTALLATION PROCESS.



# Equipment Operation

## Canvas

### BIMINI TOP INSTALLATION/PARTS IDENTIFICATION

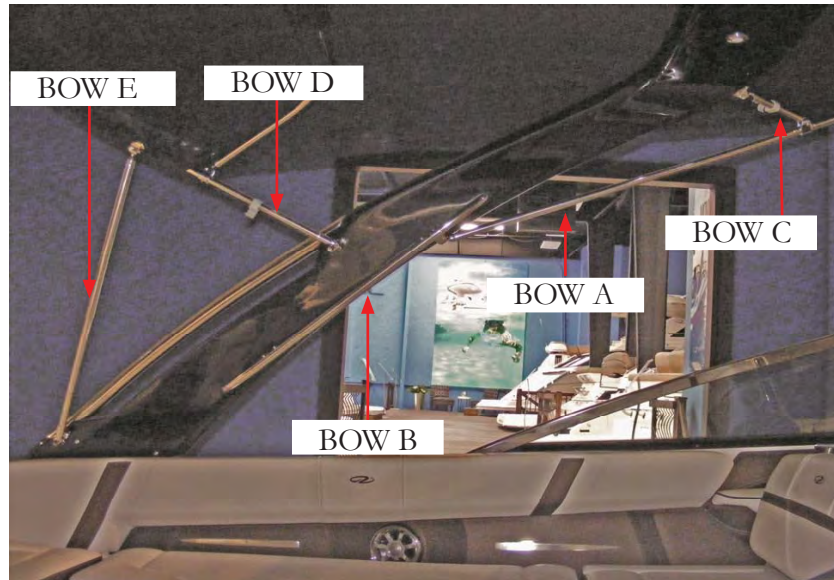

VIEW A

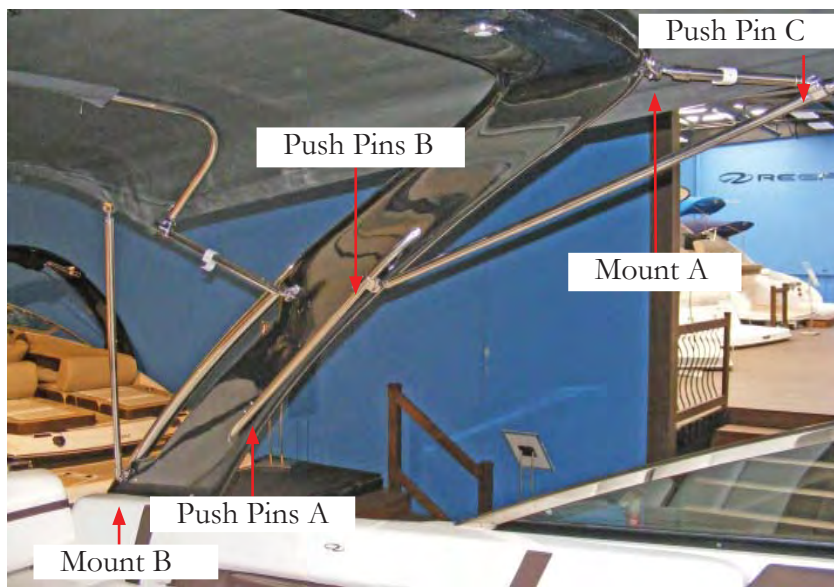

VIEW B



## CHAPTER 6

---

### Canvas

---



BEFORE



AFTER

B. DISENGAGE CONNECTOR FROM BOW A



## Equipment Operation

---

Canvas

---

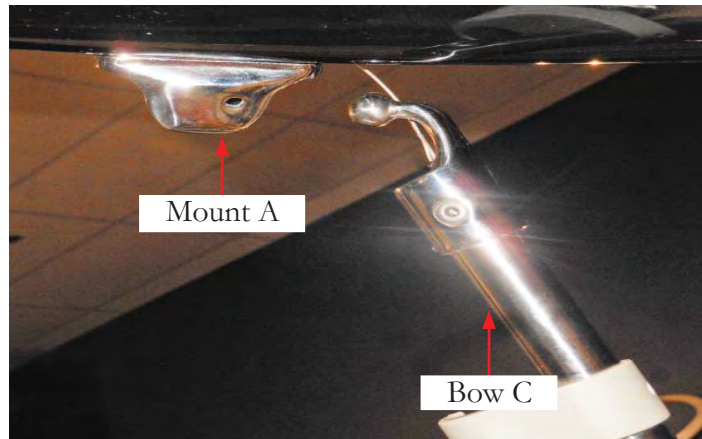

BEFORE



AFTER

C. ATTACH BOW C TO MOUNT A.



## CHAPTER 6

---

### Canvas

---



D. LOCK BOW C (FORWARD) AND MOUNT A IN PLACE USING THE PIN PROVIDED.

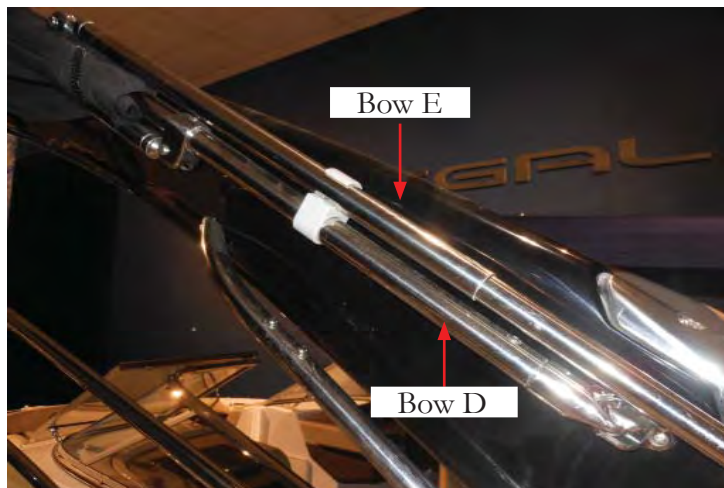

E. NEXT, DISENGAGE BOW E FROM BOW D.





## Equipment Operation

---

### Canvas

---



F. SLOWLY PULL BOW E TOWARDS THE TRANSOM & ATTACH ITS END TO MOUNT B.



G. LOCK BOW E (AFT) AND MOUNT B IN PLACE USING THE PIN PROVIDED.



## CHAPTER 6

---

### Canvas

---



BEFORE



AFTER

H. UNROLL THE CANVAS



## Equipment Operation

---

### Canvas

---



BEFORE



AFTER

I. BRING THE CANVAS TOWARDS THE FRONT AND PLACE ITS CENTER OPENING ONTO THE NAVIGATION LIGHTS.



## CHAPTER 6

---

### Canvas

---



J. APPLY PRESSURE TO PUSH PIN A IN ORDER TO RELEASE BOW A FROM ITS LOCKED POSITION.



K. ALLOW BOW A TO MOVE FREELY ALONG BOW B.



## Equipment Operation

---

### Canvas

---



BEFORE



AFTER

L. SNAP CANVAS ONTO BOW Δ (CENTER POINT).



## CHAPTER 6

---

### Canvas

---



M. USE CANVAS ZIPPER TO ATTACH REMAINDER OF THE CANVAS ONTO BOW A.



## Equipment Operation

---

Canvas



BEFORE



AFTER

N. LOCK BOW  $\Delta$  (FORWARD) IN PLACE USING PUSH PINS B.



## CHAPTER 6

---

### Canvas

---



BEFORE



AFTER

O. LOCK BOW C (FWD) IN PLACE USING PUSH PIN C.  
(REFER TO PICTURE)





## Equipment Operation

---

### Canvas

---



BEFORE



AFTER

P. SNAP CANVAS ONTO POWER TOWER.  
(LOCATED ON TOP OF ARCH)  
\*STEPS O & P MAY BE INTERCHANGEABLE



## CHAPTER 6

---

### Canvas

---



Q. COMPLETED BIMINI TOP ASSEMBLY.

\* REVERSE THE INSTALLATION PROCESS IN ORDER TO DISASSEMBLE THE BIMINI TOP COVER.



## Equipment Operation

---

Canvas Notes: While cruising all bimini tops/sunshades should be zipped in the boot to avoid damage due to wind or sea conditions as well as from possible higher cruising speeds. The same procedure shall be followed for highway towing.

Always roll not fold any loose canvas pieces to help curtail any damage especially with see through (clear) parts.

### NOTICE

NOTE: BECAUSE OF THE BEAM SIZE ON THE 2800 SELECT STATES REQUIRE SPECIAL PERMITS TO TOW THE VESSEL. CHECK WITH STATE AND LOCAL AUTHORITIES FOR MORE SPECIFICS BEFORE ATTEMPTING TO TOW VESSEL ON HIGHWAY. PRIVATE TOWING SERVICES FOR HIRE ARE AVAILABLE IN MANY LOCALS.



### CAUTION

TO PREVENT BODILY INJURY AND PROPERTY DAMAGE, DO NOT TOW BOAT WITH ANY CANVAS PARTS INSTALLED. TOW BOAT WITH ALL CANVAS ZIPPED IN BOOT. FOR CRUISING WHEN NOT USED, SECURE BIMINI TOP/SUNSHADE IN BOOT.



## CHAPTER 6

---

### Canvas: Cockpit Cover

---



The optional cockpit cover installs over the windshield and snaps to the deck. To install the cockpit cover, start at the bow area. Complete snapping the canvas to the outside and then down each gunnel to amidships.

Cockpit covers normally use adjustable poles. If installed, their purpose is to keep the canvas tight and water out of the interior. There

may be on the underside of the cover a reinforced canvas material with a snap. This is used to fasten the pole. See illustration. Each pole is adjustable by opening it to the desired length and latching clamp. You may find it helpful to mark the poles so their length remains constant to create a water shed.

**Note: Do not pull the vessel on the highway with the cockpit cover installed as damage may occur.** Take down cockpit cover and store in a dry locker.



## Equipment Operation

---

### Canvas-Bow

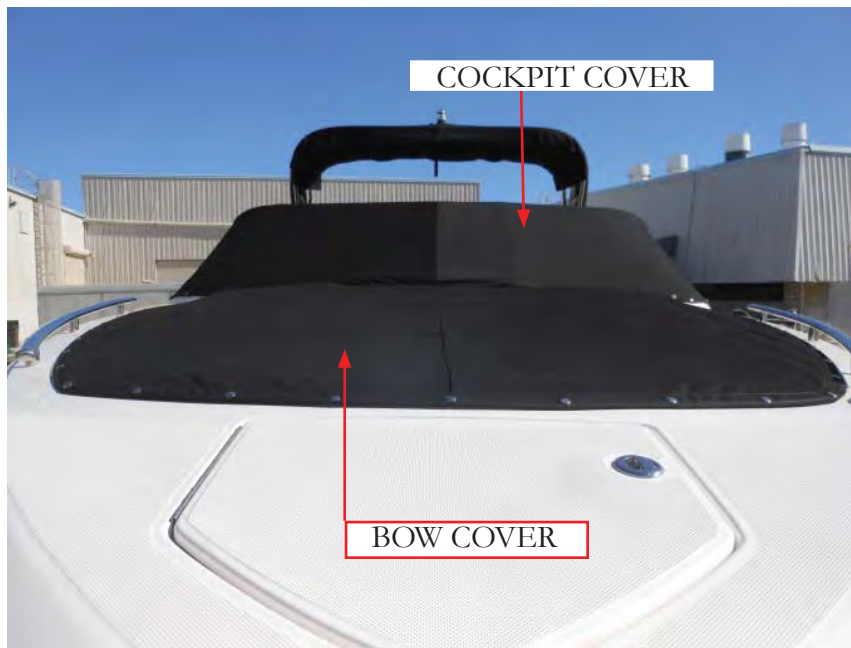

TYPICAL TONNEAU (BOW) COVER

The optional bow cover (sometimes called a tonneau cover) is used mainly for mooring purposes and foul weather conditions.

To set it up, fasten the cover starting at the front center snap working your way around the port and starboard sides. When you reach the aft section fasten the snaps to the center windshield. Install the pole at the center of the cover at the designated point which is designed to fit the pole. If equipped, select poles are adjustable.

You may want to purchase an optional storage (mooring) cover. They can be ordered from your authorized Regal dealer.

**Note: Do not pull the vessel on the highway with the tonneau cover installed as damage may occur.** Take down tonneau cover and store in a dry locker.



## CHAPTER 6

### Canvas- Typical Travel/Storage Cover

**▲ WARNING:** To prevent damage to your boat and/or cover please read and understand instructions before attempting to use cover.

It features:

1. **ON SOME MODELS:** A special anti-pooling system is included to prevent large puddles from ruining your cover.
2. The SurLast® all-weather fabric was chosen to allow stability, water repellency and breathe-ability.

4. The new ratchet and drawstrap type attachment will allow easy, tight and secure installation.

#### CARE, WARRANTY AND INSTALLATION INSTRUCTIONS

**Hint:** To properly install ratchet strap system:

1. Pull the webbing through the channeled ratchet cylinder and tension while ratcheting to "start" the webbing.
2. Tension the ratchet with about 5 lbs. of pressure (pinky finger). Pull the sides of the cover to even the webbing throughout. Re-tension about 5 lbs. (the ratchet should be tight on the side of the boat lever, perpendicular to the hull).
3. Crank the ratchet approximately 5 full additional times to add tension (based on an 18' boat).
4. Check boat webbing for tension during stops while trailering. (webbing may stretch during first installation and use CHECK OFTEN).

**▲ WARNING:** Readjust and retighten the cover after trailering and before storage. To prevent pooling do not allow snow and ice to accumulate on the cover.

**CARE INSTRUCTIONS-** Wash with warm soapy water (while installed if possible) and allow to air dry. For stubborn stains, mild detergent is recommended.

Storing the boat in constant direct sunlight will shorten the life of the cover and the components used to construct it. We recommend storing the boat in a location that exposes it to some sun and also shades it throughout the day. Preferably morning sun and afternoon shade.

#### A. Pooling System Installation:

**Note:**

Install anti-pooling system as per illustration putting the front webbing to the cleats, standing pole upright. Pull the other two webbing straps to the two rear cleats. Tighten adjustable buckle strap, until the pole stands upright.

#### B. Proper Cover Installation:

- Place cover on boat starting at front, use cleats as buttons to keep cover in place, work toward back over pooling system until back cleats are "buttoned" in place.
- Maneuver in place until cover fits over gunwale. Check the symmetry. Connect the confidence straps through the openings on the swim platform to the "U" bolts. Disconnect velcro wrap around ratchet. Begin ratcheting by unzipping ratchet pocket(s) and pulling ratchet(s) handle in right-to-left motion until zippered ratchet pocket no longer sags but rests against the hull.
- Pull on webbing to even the tension around the cover and again tighten the ratchet until it does not sag but rests against the boat. Tighten ratchet four to five more times. The ratchet should be very hard to pull with your pinky finger. Zip ratchet pocket closed and connect velcro wrap around ratchet pocket. **On some models:** Connect the rear strap tiedowns in the back of the boat.

**Note:** Proper installation and operation of this cover requires that it be very tight at the gunwale. Retighten as necessary before, after and during stops while trailering. **BE SURE** cover is installed below gunwale before final ratchet adjustment. ZIP ratchet pocket closed for final installation.

**▲ Warning:** Zippered ratchet mechanism should be hand tightened only. Do not pry or attempt to operate ratchet mechanism with any type of tool.

#### REMOVAL-

- Disconnect velcro wrap & zip open ratchet pocket.
- Follow instructions on ratchet label to release pressure.
- Once pressure is released pull out webbing to allow simple future installation, then close handle and ZIP POCKET closed (this is important to prevent damage in future installation).
- Disconnect holddown straps. Remove and fold cover working from rear to front.

#### ANTI-POOLING POLE STORAGE-

- Disconnect anti-pooling pole from either the front (colored webbing) or back.
- After disconnecting collapse poles by pushing buttons and telescoping them down.
- Wrap webbing around poles.

ISBLANKMOORING/R0

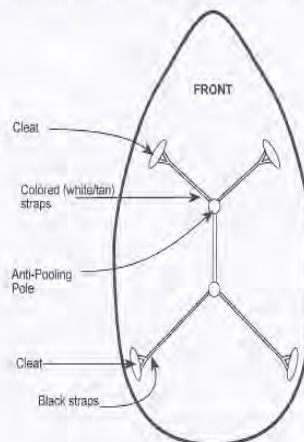



## Equipment Operation



TYPICAL TRAVEL/STORAGE COVER



RATCHET STRAP

If installed, ensure the ratchet strap is tight and tie cover securely. In colder climates check periodically for proper fit in off season storage.

Note: For highway towing with the travel cover the Power Tower should be in the “up” position.

**Note: Refer to the travel cover vendor information concerning safe highway towing speeds.**



## CHAPTER 6

---

### Cockpit Carpet

---

Cockpit carpet features a forty ounce weight with an “aqua tread” slip resistant backing. As required, snaps are installed.

When storing the carpet, roll it up verses folding it. If the carpet gets wet dry out before attempting to store it. This will help prevent mold in warmer climates. Unsnap individual fasteners carefully when storing carpet to help protect the snaps from pulling out. Do not yank on the carpet to remove it.

For cleaning instructions, see the care and maintenance chapter.





## *Equipment Operation*

---





## CHAPTER 6

---

### Cockpit Heater

---

If installed, the cockpit heater uses warm engine water, runs it through a heat exchanger and applies air through a blower which exhausts in cockpit and helm vents. It is especially useful after water sports or cruising in the early spring or late fall weather.

There is a 3 speed rotary helm switch to control output velocity.



## Equipment Operation

---

### Cockpit Refrigerator

---

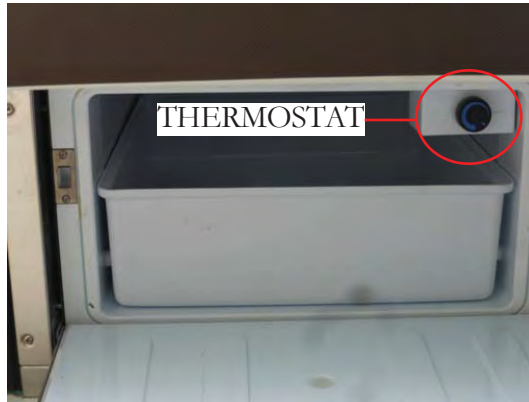

If installed, the cockpit refrigerator is located at the helm area walk through. The unit operates from 12 volts and features an ice tray and brushed stainless steel door.

To regulate the temperature there is a control knob positioned near the refrigerator

rear wall. Rotate the knob to the right to lower the desired temperature setting.

On units without the battery charger option deactivate the unit and clean out any foods after each outing. If the unit is turned on it will slowly drain the battery bank.

With the battery charger option the refrigerator can be left energized with an extension cord plugged into the vessel outlet.

It is a good idea to leave an open box of baking soda in the unit to help eliminate any food odors.

Periodically clean the unit inside with a solution of bleach and water.

Prop empty refrigerator door open when leaving vessel for extended periods of time to inhibit mold growth and food odor.

Follow manufacturer's information for defrosting the unit.



## CHAPTER 6

---

### Cockpit Seagrass Mat

---



If installed, cockpit seagrass mats feature urethane backing for marine environments. The mats provide style, comfort and durability as well as additional protection in environments where microbes are a concern.

Chilewich® products contain Microban®. This antimicrobial protection inhibits the growth of stain and odor-causing bacteria, mold

and mildew for the product's life.

When storing your seagrass mats, always roll with the face of product out with the backing facing in. Do not fold or crease as the backing may split. Vacuum or hose off for regular cleaning. Dry face up or hang. Do not machine wash. Matting may be cleaned with a mild detergent and a sponge. Rinse with fresh water.



## Equipment Operation

---

### Cockpit Table

---



Typical Installation

As an option, a teak cockpit table may be installed. When using a table ensure the table pedestal leg is installed in the receiver securely. Pull the latch pin and hold until the table pedestal leg slides in the receiver sleeve. Then release the latch pin. When installed, there are normally table receivers located in select areas. Periodically lubricate the latch pins with a silicone lube spray.



## CHAPTER 6

---

### Depth Finder/Sounder

---



In theory the depth finder picks up a bottom signal sent through a transducer to the helm gauge unit which is converted to readings in feet, meters, or fathoms and displayed on the gauge. The unit features shallow or deep water alarms, both of the audio and visual type, and keel offset.

#### General Description

The depth finder will display depths of 2-199 feet, 1-92 meters, or 1-54 fathoms. To accommodate greater depths to be displayed in the “ft” feet mode the depth sounder will automatically change to “F” fathoms mode and continue to display depths to around 54 fathoms.

When the depth decreases below 200 feet the display will return to the “ft” mode. Limits on depth will vary depending on transducers and bottom conditions.

If the reading is less than 19.9 feet, meters, or fathoms, 1/10th increments will be displayed. If the reading is more than 19.9 feet, all readings will be in whole numbers.

The depth finder features an audible and LCD displayed depth alarm with adjustable shallow and deep limits and a depth below keel offset feature. These settings once made are stored in memory and will remain even if the battery is not connected. Store vessel with bow slightly tilted for proper drainage.



## Equipment Operation

---

### Operation

---

**Power On.** When the helm is powered up by the key switch 12 volt DC energy is available at the depth gauge along with the remainder of the instrument cluster. You do not need to press the “ON/OFF MODE” keypad.

The LCD will illuminate showing the depth and the type of units selected; feet (FT), meters (M), or fathoms (F). To deactivate the depth sounder, hold the “ON/OFF MODE” keypad for 4 seconds. If you press the “ON/OFF MODE keypad again the unit will be reactivated.

**Depth Alarm. *Shallow mode:*** If you press the “ON/OFF” MODE” keypad again the “SH” shallow depth alarm setting is displayed. This is the shallowest water that will energize the alarm. Press and hold the up or down arrow keypads to adjust the reading to the desired depth.

**Depth Alarm. *Deep Mode:*** By pressing the “ON/OFF MODE” keypad displays again the “DP” deep depth alarm setting. This is the deepest water that will energize the alarm.

Press and hold the “UP” or “DOWN” keypads to adjust the reading to the desired depth. When the shallow depth setting is read by the depth finder, the “SH” will flash on the LCD and the audible alarm will sound in a rapid sequence. When the deep depth setting is read by the depth finder the “DP” will flash on the LCD and the audible alarm will sound at 2 beeps per second.

**Note:** To fully deactivate the alarm, reset it to zero. Pressing the “ON/OFF MODE” keypad temporarily deactivates the alarm. To reactivate the alarm press the “ON/OFF MODE” keypad until the depth reading appears.



## CHAPTER 6

---

**Keel Offset.** By pressing the “ON/OFF MODE” keypad again displays the “KL” keel offset setting. It can be set so the depth finder shows the depth below the transducer or the depth under the keel. Press the “UP” or “DOWN” arrow keypads to adjust the reading to the desired depth no further than 19.9 feet.

An example would be if the keel bottom is 3 feet below the transducer and you desire the depth sounder to read the depth below the keel, the display should be adjusted to read 3.0 FT.

**Note:** Once the keel offset is programmed, the shallow and deep alarms will be energized by the depth under the keel.

**Units.** Pressing the “ON/OFF MODE” keypad again displays “UN” on the LCD indicating the units mode.

Press either the up or down arrow keypads to set the units desired to (FT) feet, (M) meters, or (F) fathoms. Once these units are set, they will remain the same for all modes. By pressing the “ON/OFF MODE” keypad again returns the depth finder to normal operation.



Note: Near the keel (center of boat bottom) the depth sounder transducer is located. It bounces a constant signal off the bottom and sends it to the dash head unit. Never use bottom paint on the hull side of the transducer since it will effect the unit's operation.





## *Equipment Operation*

---

### **Docking Lights**

---

If equipped, docking lights are integrated into the hull. They are very useful for night mooring approaches and maneuvering. To operate turn on the helm switch marked “docking lights”. It is recommended not to use the docking lights while navigating in open water at night since the illumination could cause a glare on the bow navigation light possibly causing visibility problems. There is a dedicated “docking light” switch near the helm.

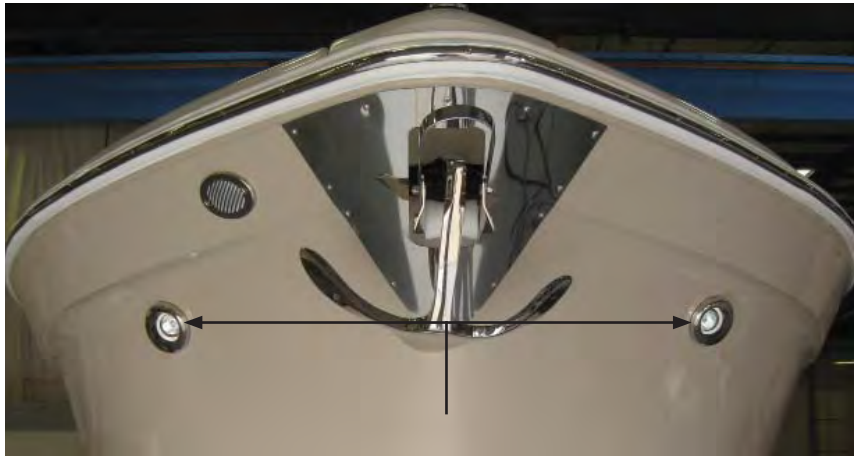

Typical Docking Lights



## CHAPTER 6

### Drain Plug



## CAUTION

TO PREVENT VESSEL FROM SINKING,  
INSTALL DRAIN PLUG!

TIGHTEN-CLOCKWISE

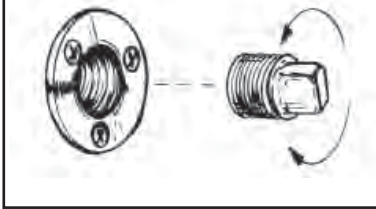

Your vessel is equipped with a hull drain plug. It is located at the aft keel area mounted on the transom. Make sure it is tightly installed before launching. *Tighten with a wrench but do not overtighten it.* Do not use your fingers alone. Before **dry** storing it is recommended to remove the drain

plug to help eliminate any bilge water accumulation. When the water stream is diminished, remove any foreign objects stuck in the drain hole. Remove the drain plug if dry storing the boat for extended periods especially in colder climates. Place the plug in a bag and attach to the steering wheel.



TYPICAL DRAIN PLUG



## Equipment Operation

---

### Engine Hatch

---



Typical Switch Panel

The engine hatch is controlled by a cockpit switch panel. The system uses an actuator to lift the hatch which is located in the sump. To lift or lower the hatch energize and hold the momentary switch. When the hatch reaches a complete open or closed position it will

begin to ratchet. At this point release the switch.

Always monitor the hatch operation as all body parts need to be kept away from the hatch. Periodically check the actuator where it connects to the hatch hardware. Look for excessive wear and any loose hardware.

Hatch Actuator





## CHAPTER 6

### Fresh Water System (Pressurized)

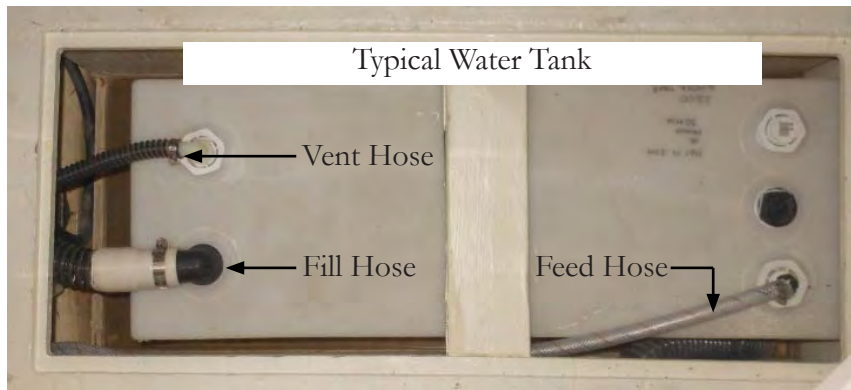

The fresh water tank is located under the amidships cockpit floor. The capacity is approximately 18 gallons. A feed hose connects the system to the fresh water pump/strainer for distribution purposes. In cold climates, follow appropriate winterization procedures for the entire water system.

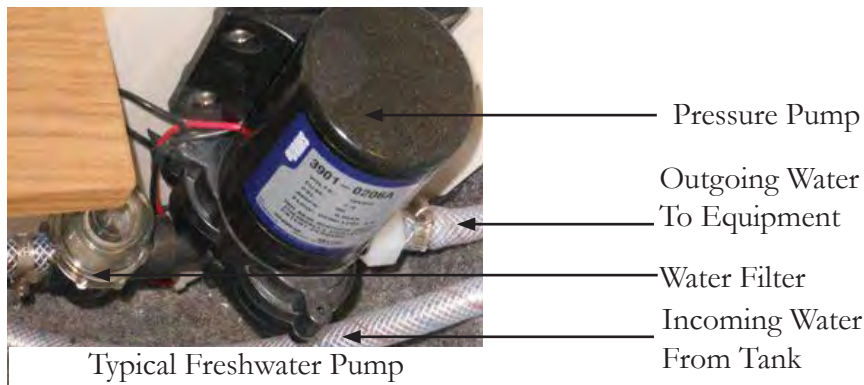

The fresh water pump is located forward of the fresh water tank under the cover. Remove the screws to access the pump/filter.

Note: The fresh water tank level should be topped off before leaving the dock. Ensure the water quality before filling the tank at the deck fill marked “water” located on the bow.



## Equipment Operation

---

### To Fill Fresh Water System:

1. Unscrew the “water” fill deck fitting. Fill the fresh water tank with fresh water with a suitable container or hose. Make sure the water is safe for drinking.
2. Find the fresh water pump switch/breaker located on the 12 volt head panel and pull the switch out to engage it. You will hear the pressurized water pump fill the entire fresh water system. When full the pump pressure switch will stop the pressure pump.
3. Open the head faucet to allow any air to escape. Close the faucet when there is a steady stream of water without air. You will hear the fresh water pressure switch shut off indicating the system is full.
4. After these initial procedures, “top” the system off with fresh water.
5. Check for system leaks as evidenced by the pressure water pump recycling even though no water is being used from the components.
6. It is a good idea to turn “off” the fresh water pump switch after each use and especially during extended times of non-use.
7. Clean the pressure water filter periodically by disassembling the filter element and rinsing in fresh water. Ensure the pump switch is off. Replace and check for leaks. For parts, contact an authorized Regal dealer.

	<b>CAUTION</b>
AVOID PRESSURE PUMP BURN OUT! DO NOT ACTIVATE THE FRESH WATER SYSTEM WITH THE WATER TANK EMPTY.	



## CHAPTER 6

---

### Gas Vapor Detector

---

If equipped, a gas vapor detector is a state of the art fume monitoring and alarm system. It is a highly effective detector of engine compartment gasoline fumes from unburned hydrocarbons emitted from faulty exhaust systems and hydrogen battery vapors.

The unit operates with a head unit at the helm, a sensor located in the bilge installed just above the normal accumulation of oily bilge water. A .5 amp buss fuse (for over current protection) is located behind the helm head unit.

#### Operation

The display panel at the helm features 3 windows. The left window is a green power on indicator. The right window is an opening for the Var-a-Brite light intensity detector. The center window is the red warning indicator.

To check for fumes, turn the ignition key to the "on" position. The green power on LED will illuminate and the red warning LED may light momentarily to indicate a warm-up period for the sensor. The alarm horn will not sound during this period.

If a vapor build-up reaches 10-20% of lower explosion limit the red warning LED will light indicating a detection of fumes. Should this condition last for longer than 10 seconds, the alarm horn will sound. The alarm will continue as long as vapors are present. The alarm horn may be silenced by pressing the "mute" switch; the Red warning light will remain on until the vapor problem has been resolved.

**NOTE: THE PROBLEM SHOULD NEVER BE CONSIDERED CORRECTED UNTIL RED WARNING LIGHT IS OUT.**



## Equipment Operation

---

If the red LED begins to glow softly and or intermittently, it is an indication that the gasoline vapor build-up is beginning to occur and you can anticipate a full alarm momentarily. Immediately have all passengers and crew exit the passenger compartment. If an explosion or fire should occur, the probability of injury will be greatly reduced if no one is in a confined area of the vessel.

### **IN THE EVENT OF AN ALARM:**

NOTE: IT IS IMPORTANT TO UNDERSTAND THAT AN ALARM WOULD NOT OCCUR UNLESS A PROBLEM EXISTED. CAREFULLY CHECK ALL FUEL LINES, GAS LINES, AND ANY OTHER POTENTIAL SOURCES OF GAS LEAKS.

### Testing System



The head unit can be tested for electrical continuity by pressing the "Test" switch. The Red LED will come on. The light will glow as long as the switch is held down. If the test switch is held down longer than 10 seconds the horn will sound and the "MUTE" switch must be pushed to silence the horn.

Unplug the sensor wire from the helm display head while the unit is powered up. The Red LED will illuminate and within 10-15 seconds the alarm horn will sound. If warning Red LED fails to come on & horn fails to sound, remove display head & return to factory for repair.



## CHAPTER 6

---



### **WARNING**

AVOID INJURY AND DEATH!  
GASOLINE VAPORS CAN EXPLODE!  
OPERATE BLOWER FOR AT LEAST 4 MINUTES  
AND CHECK THE ENGINE COMPARTMENT  
AND BILGE FOR GASOLINE VAPORS.  
RUN BLOWER BELOW CRUISING SPEEDS.





## *Equipment Operation*

---

### **Grey Water System**

---

The grey water system option consists of a holding tank along with a deck mounted waste pump-out fitting. Water from a head sink normally exits the boat at a through hull fitting. With the grey water system any used potable water is stored via the drain system to a holding tank through the use of a sump type pump and box. Once the grey water holding tank is full it is pumped overboard by a pumping station vacuum pump much the same way a toilet holding tank is pumped out.

This system is environmentally friendly as it keeps many soap related alkalies and harsh detergents out of the water supply. Check with local and state agencies regarding grey water regulations as select lakes and waterways require grey water systems.



## CHAPTER 6

---

### Grill

---

If installed the marine gas grill uses small bottles of propane as a fuel source. Grill receivers may be located on the aft swim platform area and this is the only approved location for grilling. **Read and understand all instructions before using the grill. Make sure grill is mounted securely before using. Let grill cool down before storing unit.**

#### Gas Grill- Barbecue Safety Instructions

1. The unit is designed to cook food like meat, fish or vegetables. Do not use it for any other purpose since it could be dangerous.
2. Do not operate the barbecue in rough seas or while under power.
3. Do not use burning type charcoal briquettes or volcanic stones.
4. Never light the barbecue with the lid closed.
5. Never grill with the canvas in the up position to help prevent CO poisoning. Read and understand warning label on next page.
6. Keep combustible material away from the barbecue.
7. Keep children away from hot barbecue parts.
8. Do not store propane bottles on board the vessel.
9. Let the unit cool down before attempting to store the grill.
10. Always change propane tank away from any ignition source.
11. Do not tamper or modify any parts adjusted or sealed by the manufacturer.
12. Periodically check all components for leaks, corrosion and wear.



## Equipment Operation

---



Typical Grill

13. When installing a propane bottle make sure it is screwed into the grill receptacle tightly. Use a spray bottle with soapy water to check for leaks. See the information on gas leaks.

14. Never try to adjust the regulator. It is factory set for best operation.

15. Use common sense around the grill. A portable fire extinguisher shall be readily available.

17. **Never leave the grill operating unless an adult is supervising the device.**



### **WARNING**

OPEN FLAME COOKING APPLIANCES CONSUME OXYGEN AND PRODUCE CARBON MONOXIDE. TO AVOID ASPHYXIATION, OR INJURY OR DEATH FROM EXPOSURE TO CARBON MONOXIDE, MAINTAIN OPEN VENTILATION WHEN USING THESE APPLIANCES. DO NOT USE THIS APPLIANCE FOR COMFORT HEATING.



## CHAPTER 6

---

### Typical Gas Grill-Operating Instructions

- A universal mount is required to attach the grill to the deck fitting.
- Fit the grill-mount assembly to the grill and into the deck fitting. Make sure the grill is positioned securely.
- Screw on the propane bottle.
- With a long match or propane starter apply flame to the burner. Always apply the flame to the burner before turning on the gas.
- The control knob now can be turned to start the grill.



## WARNING

GASOLINE VAPORS ARE EXPLOSIVE!  
OPEN FLAME APPLIANCES CAN IGNITE GASOLINE VAPORS  
TO AVOID INJURY OR DEATH FROM EXPLOSION OR FIRE,  
TURN OFF ALL OPEN FLAME DEVICES.



## *Equipment Operation*

---

- Turn the grill on high. Make sure there is heat coming from the unit.  
If after 10 seconds the burner has not ignited or your flame has gone out turn the unit off and wait 1 minute for the propane to dissipate.
- Once lit, adjust the flame to the desired temperature. No preheating time is necessary.
- Do not leave the grill operating unattended.
- After cooking , shut off the grill and allow the unit to cool.
- After cooling, wipe up any grease build-up. Clean after every use to keep the grill operating correctly.
- Do not store grill until unit is completely cooled down as a fire could develop.



## CHAPTER 6

---

### Gas Leaks

1. Extinguish all flames, smoking materials and turn engines off.
2. Turn off the grill knob.

To determine the source of the gas leak:

1. Screw on the propane tank until secured.
2. With the grille in a well ventilated area and the burner turned off do the following.
3. Apply a mixture of liquid detergent and water to all connections checking for bubbles indicating a leak. If a leak is found tighten the connection and verify with soap solution as above that the leak is stopped before attempting to light the barbecue grill.



## Equipment Operation

### Ladder-Transom



Typical Aft Ladder w/ Lock Tabs

Your vessel is equipped with a stainless steel transom boarding ladder sometimes referred to as a swim ladder. Be sure all body parts are clear of the ladder when folding the ladder up or down and repositioning it under the swim platform. Make sure the ladder is inserted into the locking tabs.

Be sure to read and understand any written warnings posted at the helm area or swim platform regarding ladder load limits and CO (carbon monoxide poisoning).

**Always turn the engine off and remove the ignition keys while people are in the water near the boat, or**

**using the swim platform and/or bow and transom boarding ladders.** Also, insist people always use the ladder and **never use the stern drive ventilation plate for entering and exiting the vessel.**

Again, safety first!

Periodically rinse the ladder frame and rungs to keep the device clean and in a non-slip condition. Salt water usage will require even closer attention to cleaning cycles over fresh or brackish water.

**Note: Before cruising, ensure the ladder is stowed properly.**



## CHAPTER 6

---



### **WARNING**

AVOID BODILY INJURY DUE TO MOVING PARTS!  
KEEP ALL BODY PARTS CLEAR OF THE LADDER'S  
MOVING AND ROTATING PARTS!





## *Equipment Operation*

---

### **Lighting-Stern/All Around**

---

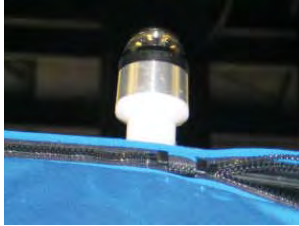

Power Towers use an all-around light which is mounted at the center of the tower top. It is controlled by the navigation-anchor helm switch. It must be used between dusk and dawn and must be lighted when the vessel is stopped or anchored at night and shall be visible 360 degrees.



## CHAPTER 6

---

### Power Platform

---



As an option the power platform when extended permits a person in the water easier access to board the vessel. There is a switch normally mounted in the aft cockpit to operate the platform. Never operate or use device with the engine running or making headway in any direction.

Remember to keep the keys out of the ignition while

people are in the water.

**Note: Before starting the engine and making any headway make sure the power platform is at its highest level and tucked under the swim platform**



## *Equipment Operation*

---

### **Power Tower**

---

As part of the innovative design the tower hinges forward for tight overhead clearances such as bridges and restricted storage situations. The tower features a fiberglass framework with overhead lights, all around navigation light and/or ski pylon.



**For highway towing the power tower shall be upright and all canvas stowed in their dedicated boots. All attached canvas bow hardware shall be checked for tightness before and after towing. Cockpit carpet shall be rolled up and stored in a dedicated cockpit dry floor locker.**



## CHAPTER 6



Typical Power Tower Canvas Shown In Booted Cruise Position



Typical Power Tower Shown In (Bridge) Full Forward Position



## Equipment Operation

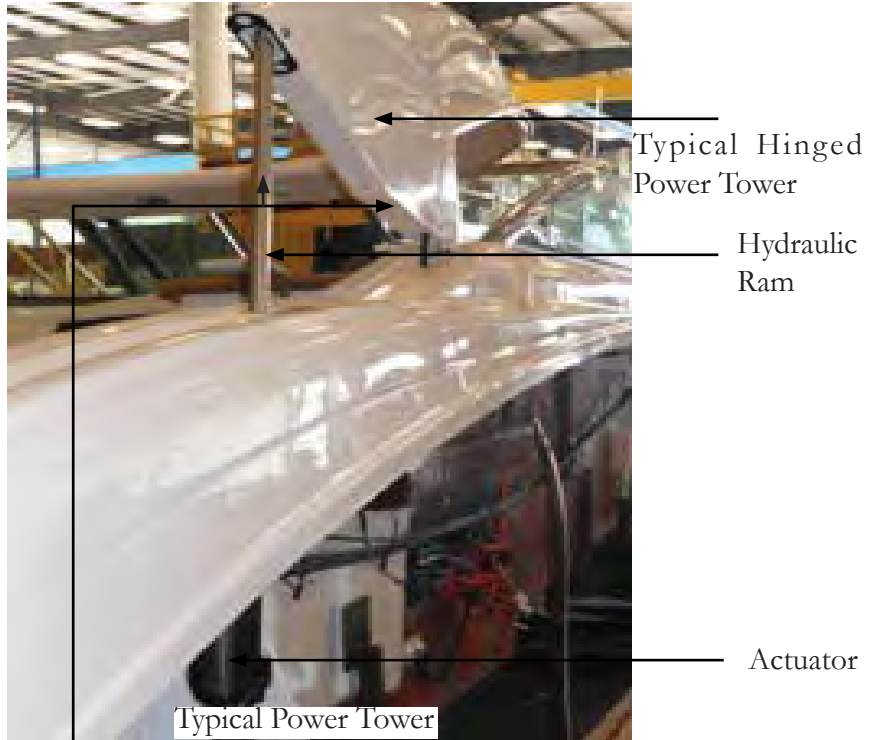

 **CAUTION**

WHEN OPERATING WAKESPORT TOWER  
KEEP ALL BODY PARTS CLEAR  
OF TOWER HINGE MECHANISMS.



## CHAPTER 6

---

The Power Tower can be hinged forward for clearance purposes. Normally one of the switches at the helm area is designated as arch or tower. It connects to a lift motor and a set of hydraulic rams that raise or lower the Power Tower when the switch is activated.



### **WARNING**

WHEN OPERATING POWER TOWER  
KEEP ALL BODY PARTS CLEAR  
OF TOWER HINGE MECHANISMS.

*Make sure the operator and all aboard read and understand the above warning. Before energizing the arch switch. Explain to all passengers that they must maintain a safe distance from the tower hinge mechanisms located at the base of the power tower on the deck. As the operator energizes the switch to hinge the tower forward visually monitor the port and starboard deck to ensure all passengers body parts are clear of the hinge mechanism. This same procedure applies for lowering the mechanism to the original position.*



## Equipment Operation

---



The Power Tower features an actuator control box. This component is located in the sump (bilge). The unit provides overcurrent protection through a set of breakers on the face of the actuator box. Facing the box the left reset breaker protects the port power tower lift actuator. The center reset breaker protects the starboard power tower lift actuator.

The far right breaker protects the entire circuit wiring. If the Power Tower fails to raise check the box for an “open” breaker. Always find the cause of an open breaker situation before resetting the device.



## CHAPTER 6

---

### Rear View Mirror

---

As an option a rearview mirror is available. It attaches to the windshield and provides increased visibility aft especially useful during water sports activities. Be sure to fasten the mirror tightly so it stays in place when encountering waves, wakes and maneuvering in busy waterways.

Note: The mirror does not replace the need for an observer during water sports. Periodically clean the mirror surface with fresh water and wipe dry. Do not use harsh chemicals on the mirror glass or cleaners containing ammonia.





## Equipment Operation

### Refreshment Center-Head



Inside the head is a sink and cold water faucet. Other components of the system include a fresh water tank, pressurized 12 volt pump, and cockpit wash down. As part of the fresh water pressure pump is a filter which can be easily removed for periodic cleaning. A paper holder and storage cabinet is molded below the sink. See the section on the fresh water system for further maintenance information. Refer to the winterization chapter for vessels in colder climates. Follow the procedure for “laying up” the fresh water system to prevent system and/or component damage.



COCKPIT WASH DOWN



## CHAPTER 6

### Regal Vue Display

#### Product Information

RegalVue is a touch screen display solution. It is designed for instrumentation on electronically controlled engines communicating via SAE J1939 and NMEA 2000. The display is a multi-functional tool that provides GPS tracking, Multimedia Display, Speed control and rider profiles. In addition, enables equipment operators to view many different engine parameters and service codes.



#### Care and Maintenance

General maintenance is not required; however a soft cloth can be used for cleaning the units. Window cleaner or alcohol can also be used to clean the glass portion of the display. Do not use harsh or abrasive cleaners on the unit.

Note: We continually strive to bring you the highest quality, full featured products. As a result, you may find that your actual Regal Vue display screens may be slightly different than what is represented in this manual at the time of printing.



## Equipment Operation

### RegalVue Display

#### INSTALLING/REMOVING MEMORY CARD



As an option Regal Vue is installed as shown. Each unit is outfitted with a memory card with predetermined geographical regions. Should the operator want a different memory card access to the Regal Vue panel is outlined below.

1. The battery switch should be turned to the “off” position before starting to work behind the dash. At the rear of the Regal Vue display (behind the dash) you will see a small compartment with 2 allen head type fasteners. Remove both fasteners with the panel cover to access the memory card compartment.

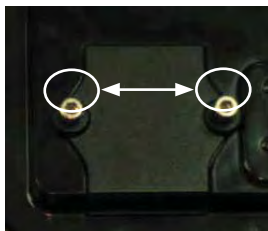

FASTENERS

2. Insert a fingernail or small slotted screwdriver into the memory card end tab. Push up to disengage the card. Next, pull down on the card to remove it from the card slot.

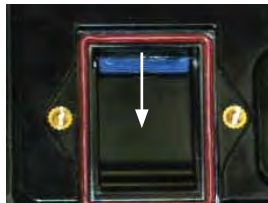



## CHAPTER 6

---

### Regal Vue Display

---



3. Install the new card with written side out into the card slot. Make sure the memory card seats into the card slot.

4. Reinstall the panel cover and tighten the allen head screws. There must be a small “crush” on the cover gasket to ensure a tight fit but do not over tighten the fasteners.

5. Energize the battery switch and test the display unit.



## Equipment Operation

---

### Seating-Double Helm w/Flip-Up Bolster



The double wide helm seat can be moved forward or aft using the momentary switch located at the helm starboard side panel.

In addition, the helm seat height can be adjusted using an additional momentary switch at

the same location. See the switch panels below.

Also, located at the forward end of the seat is a flip-up bolster which can afford you additional visibility for docking and maneuvering in tight quarters. Along with the bolster cushion in its up position, the operator gains additional standing leg room.



## CHAPTER 6

---

### Seating/Typical Bow-Arm Rests

---



Your vessel features bow seating arm rests.  
To use the arm rest simply push down on the top of the arm rest until it falls in place.



To fold away pull up on the arm rest until it rests against the bulkhead.



## *Equipment Operation*

---

### **Sirius Satellite Radio**

---

If installed, Sirius satellite radio features over 120 channels of music entertainment completely commercial-free along with sports and news channels. Sirius emphasizes the music and entertainment you want. Channels use the most updated digital filtering available for the clearest sound. Sirius uses three satellites flying over the United States for coast to coast coverage with high elevation angles. The result is a clearer line of sight and less signal blocking.

The system consists of the stereo receiver (sometimes called the head unit), Sirius radio tuner and antenna. With these components and an active account your Sirius system can be activated. Following are the activation steps to be taken:

- A. Unit must be completely installed and the antenna must have a clear view of the sky.
- B. Turn on the radio and go to satellite mode.
- C. Confirm reception by tuning to SIRIUS WEATHER & EMERGENCY//CHANNEL 184. If you are not receiving Channel 184, please refer to the radio manufacturer owner's manual.
- D. Call SIRIUS sales support 1-866-580-7234 or customer care 1-888-539-7474
- E. Please have your name, address, phone number and the SIRIUS ID#ESN available for the agent.



## CHAPTER 6

---

### Ski Tow/Pylon

---



As an option, a water sports ski pylon is located center line at the stern platform. Double loop the line first through the hole and then around the ski pylon and cinch it tightly. This procedure helps to keep the line intact when there is no strain on it.

Always appoint a person to keep their “eye out” for the tow line when the vessel is running to prevent the line “slack” from being caught in the propeller.





## Equipment Operation

### Stereo/CD Player- Fusion-Overview

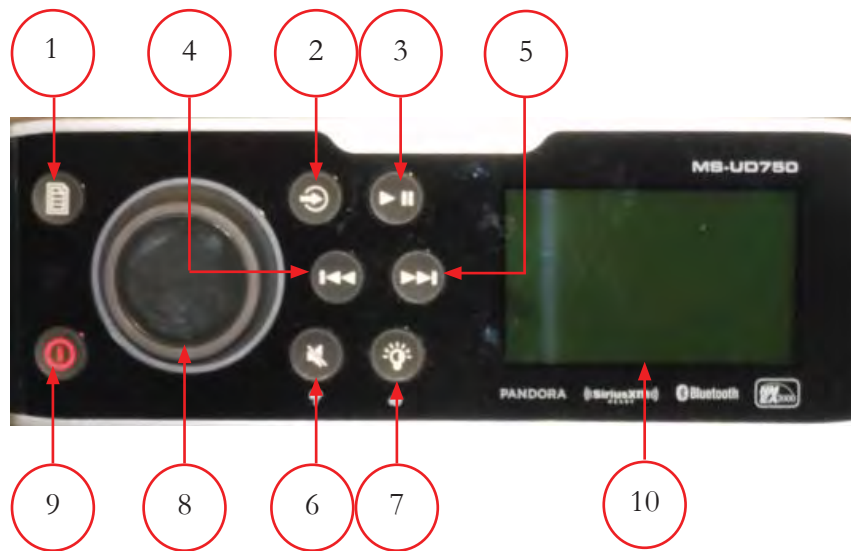

Regal boats feature Fusion® marine stereo audio systems. Fusion stereo systems are designed and engineered to perform to the highest standards in the harsh marine environment. The head units use easy to read displays, oversized rubber buttons, and controls for easier operation on a moving vessel. Being at the leading edge in stereo technology the head unit opens to a unique internal iPod/i Phone dock. The dock is compatible to many types of iPods and i/Phones.

Go to [www.fusionentertainment.com/marine](http://www.fusionentertainment.com/marine). for a listing of types along with owner's information, trouble-shooting, and FAQ down loads. The standard MS-UD650 base unit provides Class D-4 x 70 watts @ 2 ohms resistance.

All components including the speakers comply with the international IP waterproof standards. Selected optional system components include amplifiers, zone amplification and additional speakers.

The system utilizes a 15 amp automotive ATC mini fuse located behind the stereo head unit.

See the amplifier and remote information for vessels equipped with the optional stereo performance package and transom speakers.



## CHAPTER 6

<b>STEREO CONTROLS IDENTIFICATION</b>	
1	SELECT TO OPEN A MENU SELECT TO RETURN TO THE PREVIOUS SCREEN OR MENU
2	SELECT TO CYCLE THE VARIOUS SOURCES
3	SELECT TO PAUSE OR RESUME AM-FM SOURCE: SELECT TO CYCLE THRU TUNING MODES; AUTO, MANUAL, AND PRESETS (WHEN 2 OR MORE PRESETS ARE SAVED) HOLD TO SAVE STATION AS PRESET SIRIUS XM SOURCE: SELECT TO CYCLE THRU TUNING MODES (AUTO & PRE SETS) WHEN YOU HAVE AT LEAST ONE PRESET CHAN- NEL IS PRESENT
4	SELECT TO SKIP TO THE PREVIOUS TRACK, WHEN USING AN APPLICATION SOURCE HOLD TO REWIND THE CURRENT TRACK, WHEN USING AN APPLICATION SOURCE AM, FM SOURCE: SELECT TO TUNE TO THE PREVIOUS STATION HOLD FOR FASTER TUNING (MANUAL MODE ONLY) AUX-SELECT TO DECREASE GAIN-CONNECTED SOURCE SIRIUS XM SOURCE: SELECT TO RETURN TO PREVIOUS CHANNEL
5	SELECT TO SKIP TO NEXT TRACK, WHEN USING APPLICA- TION SOURCE HOLD TO FAST FORWARD CURRENT TRACK, WHEN US- ING APPLICATION SOURCE AM, FM SOURCE: SELECT TO TUNE TO THE NEXT STATION HOLD FOR FASTER TUNING (MANUAL MODE ONLY) AUX1, AUX2 SOURCE: SELECT TO INCREASE GAIN FOR CONNECTED SOURCE SIRIUS XM SOURCE: SELECT TO ADVANCE TO THE NEXT CHANNEL



## Equipment Operation

<b>STEREO CONTROLS IDENTIFICATION (CON'T)</b>	
6	SELECT TO MUTE THE AUDIO OUTPUT SELECT TO UN-MUTE THE MUTED AUDIO OUTPUT (THE VOLUME CONTINUES AT PREVIOUSLY SET LEVEL)
7	SELECT TO ADJUST THE SCREEN AND DIAL BRIGHTNESS
8	TURN TO ADJUST THE VOLUME PRESS & HOLD FOR AT LEAST 1 SECOND TO ADJUST THE WOOFER LEVELS TURN TO MOVE THRU THE LEVELS & ADJUST A SETTING PRESS TO SELECT THE HIGHLIGHTED OPTION
9	SELECT TO TURN ON THE STEREO HOLD TO TURN OFF THE STEREO
10	THE INFORMATION DISPLAYED ON THE STEREO SCREEN VARIES DEPENDING ON THE SOURCE CHOSEN.

### Using Dial To Select Items:

- Turn the dial to select an item on the screen.
- Hold to turn off the stereo.



## CHAPTER 6

### STEREO SCREEN EXAMPLE WITH IPHONE MOBILE DIGITAL DEVICE

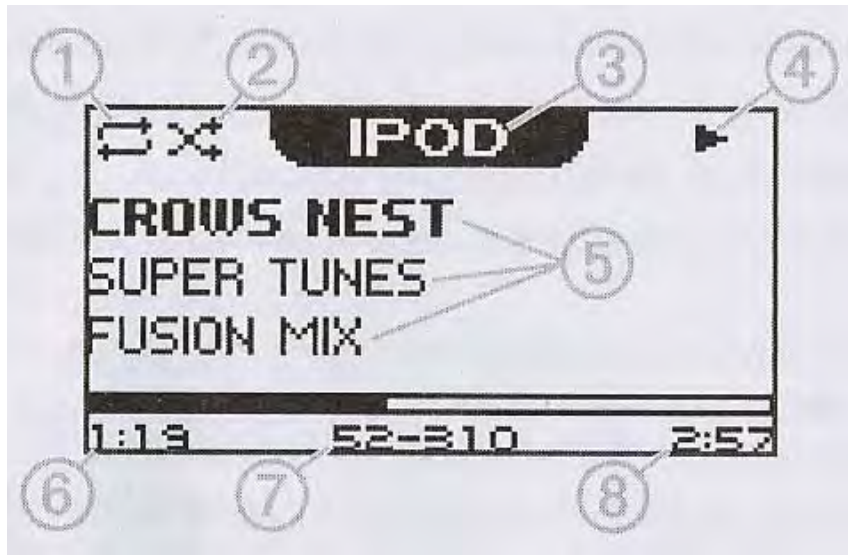

1	REPEAT STATUS ICON
2	SHUFFLE STATUS ICON
3	SOURCE
4	PLAY OR PAUSE
5	TRACK DETAILS (IF AVAILABLE)
6	ELAPSED TIME
7	CURRENT TRACK # OUT OF TOTAL NUMBER OF TRACKS IN THE PLAYLIST (IF AVAILABLE)
8	TRACK DURATION



## *Equipment Operation*

---

### **Connecting Media Players**

You may need to remove the media player from a case or sleeve to fit inside the dock.

Insert the media player with display facing up.

Never force the media player into the dock.

Be careful of heat when removing the media player from the dock since it could be warm to the touch.

Always disconnect your media player from the stereo when not in use and do not leave in the boat. This helps to reduce the chance of theft and damage due to extreme temperatures.

Do not remove the media player or use your stereo in a distracting manner while running the vessel.

The stereo accepts a variety of media players, mobile devices and smart phones. You can connect a compatible media player using a Bluetooth wireless connection or a USB connection to the integrated docking station, or the USB on the back of the stereo.

### **Connecting A Media Player Using The Dock**

You can connect a compatible media player using the universal dock built into your stereo media player.

1. Slide the button on the top of the stereo, and pull down to open the door.
2. Slide out the device tray.
3. Insert the adapter cable 1 into the USB port 2.

Note: A USB flash (thumb) drive fits directly to the USB port; one with FAT32 or NTFS formatted USB flash drive..

4. Connect the adapter cable to the media player 3 and place it in the device tray.



## CHAPTER 6

---

5. Slide in the device tray and close the door.



### Media Player Compatibility

With the UD standard model you can use the adapter cables included to connect popular media players to the internal docking system. Only media players with the ports on the bottom, not on the sides, fit into the docking station. Media players larger than 5.67" x 2.80" x .52" do not fit into the docking station. Refer to the Fusion manual for specific media player compatibility listings.

### Media Player Compatibility

You can play media from a compatible Bluetooth device using the Bluetooth wireless connection.

1. Select the Bluetooth source.
2. Select "Discoverable" to make the stereo visible to your compatible Bluetooth device.



## *Equipment Operation*

---

3. Enable Bluetooth on your compatible Bluetooth device.
4. Bring the compatible Bluetooth device within 33 feet of the stereo.
5. On your compatible Bluetooth device, search for Bluetooth devices.
6. Select the stereo from the list of detected devices.
7. Follow the on-screen instructions to pair and connect to the discovered stereo. When pairing, your media player or smartphone may ask you to confirm a code on the stereo. The stereo does not display a code, but it does connect correctly when you confirm the message on the Bluetooth device.

To prevent interruption to audio streaming over Bluetooth wireless, turn off the “discoverable” setting after pairing a Bluetooth device to the stereo.

### **Bluetooth Range Information**

The stereo and Bluetooth wiring devices have a range of 33 feet. For optimal performance, the Bluetooth wireless device should also have a clear line of sight to the stereo.





## CHAPTER 6

---

### Playing Media

#### Selecting A Source

1. Select stereo control 
2. Select an option:
  - Turn the dial to highlight a source
  - Select  repeatedly to highlight a source.
3. Press the dial to select the source.

#### Setting The Tuner Region

You must select the region you are presently in to receive AM, FM, and SiriusXM stations properly. Sirius is not available in all locations.

1. Select stereo control # 1 from illustration>Settings>Tuner Region
2. Select your present region.

#### Changing The Radio Station

1. Select an applicable source, such as FM
2. Select  repeatedly to cycle through the tuning mode.
  - Select Auto to scan and stop on the next available station.
  - Select Manual to select a station manually.
  - Select Presets to select a saved station preset.
3. Select backward or forward to tune to the station.





## Equipment Operation

---

### Sirius Satellite Radio

Only SiriusXM brings offers you a complete menu of music all in one place. Over 140 channels including commercial free music plus the best sports, news, talk, comedy and entertainment. A Sirius tuner and subscription are required as part of a Regal boat option. Normally the receiver is located on the deck for best reception.

The Sirius is available in the 48 contiguous United States and the District of Columbia, and with certain limitations in Puerto Rico.

### Controlling Pandora Radio With The Stereo

You can control Pandora using the stereo instead of your mobile device. While you are controlling Pandora using the stereo, you cannot control Pandora using your mobile device.

1. Connect to the mobile device using a USB or Bluetooth connection.
2. Select Pandora.
3. Select Enable Pandora to fill the radio button.
4. If necessary, select an option:
  - To pause the stations, select 
  - To skip to the next track, select the forward icon.
  - To tell Pandora you like this track and would like more tracks similar to this played on this station, select the audio icon.
  - To tell Pandora not to play this track select the undo audio icon.



## CHAPTER 6

---

### **Controlling Pandora Radio With Your Mobile Device**

1. Connect to the mobile device using a USB or Bluetooth connection.
2. Open the Pandora app on the mobile device.
3. Begin playing a station on the mobile device.
4. Control the playback with your mobile device.

### **Adjusting The Volume**

1. Use the dial to adjust the volume.
2. If necessary, press the dial to switch between zones.

Tip: To control all zones at the same time, press the dial until all zones are highlighted.

### **Charging Cellphone**

To charge a cell phone simply install a USB phone cord plug into the port and the other end into your iphone or cellphone. Ensure there is power to the stereo unit.



## Equipment Operation

---

### Stereo Remote Control

---



If equipped, the Fusion stereo remote control is normally mounted at the transom area which makes it easier to use during water activities.









It is a plug and play device and uses the same function buttons and rotary

encoder as the helm head unit. It features the ability to select various speaker zones on the vessel. Refer to the Fusion owner's manual for more detailed information.



## CHAPTER 6

### BUTTON DESCRIPTION

BUTTON	DESCRIPTION
	<b>Power</b> Press to turn the unit ON/OFF
	<b>Source</b> Press to select the desired source Radio [FM-AM-SAT] - CD/MP3 - iPod - AUX
	<b>Mute</b> Press to Mute/Un-Mute sound in all zones
	<b>Menu</b> Press to enter menu system. Press to return to previous screen
	<b>Play/Pause</b> Play/Pause track in CD/MP3 and iPod mode.
	<b>Back/Previous</b> <b>Short Press:</b> To select the previous track in CD/MP3 and iPod mode. Start automatic tuning down the frequency spectrum in the tuner mode. <b>Press and Hold:</b> Rewind in CD/MP3 and iPod mode. Start manual tuning down the frequency spectrum in the tuner mode.
	<b>Forward/Next</b> <b>Short Press:</b> To select the next track in CD/MP3 and iPod mode. Start automatic tuning up the frequency spectrum in the tuner mode. <b>Press and Hold:</b> Fast forward in CD/MP3 and iPod mode. Start manual tuning up the frequency spectrum in the tuner mode.
	<b>Rotary Encoder</b> The Rotary Encoder operates the same way as the Rotary Encoder on your FUSION Marine Stereo Unit



## Equipment Operation

---





### ALLOCATING ZONES FOR THE REMOTE.

Press and hold the Mute Button for 7-10 seconds then turn the  to select a : [Z1, Z2, Z3, Z4, Z1234]. Press to select. The Remote will then shut down and will need to be turned on.

### ZONE VOLUME

Turn the  to adjust the volume in the allocated zone

### GENERAL SETUP

1. Press the  and turn the  to select the Setup menu. Press to enter.
2. Turn the  to select the function and press to enter.
3. Turn the  to adjust and press  to return.



## CHAPTER 6

### Stereo Performance Package



TYPICAL STEREO PERFORMANCE PACKAGE UNDER SEAT COMPONENTS

The stereo performance package features extra speakers including a sub-woofer and a 2 channel amplifier to provide leading edge performance in sound and power. The simplicity of design contrib-

utes to low distortion and high efficiency. Normally the amplifier is located inside the port cockpit seat. The circuit is protected by a 30 amp breaker. The amplifier does not require any type of maintenance other than periodic checking of the wiring connectors for tightness. Refer to your Fusion owner's manual or contact your closest Regal dealer for additional information.

If the optional transom speakers are installed note that there is an additional "zone" amplifier used for these speakers. The unit requires no maintenance.



## Equipment Operation

---

### Swim Platform

---

Periodically inspect the swim ladder and platform support hardware to insure that all connections and fittings are tight and in a non-corrosive state. Never dive off the swim platform. *Do not store or add objects to the swim platform since additional weight will affect steering and maneuvering characteristics of the vessel.*

Remind passengers entering from the water to use caution in safe boarding. Never use the stern drive to access the swim platform since serious injury could result from propeller blades and/or stern drive parts. See the platform illustration on the following page.



### **WARNING**

**AVOID SERIOUS INJURY OR DEATH!  
DO NOT OPERATE THE BOAT  
WITH PEOPLE AROUND, ON TOP OR HOLDING ON TO  
THE SWIM PLATFORM STRUCTURE OR HARDWARE.**



## CHAPTER 6

---

### Swim Platform- Flexiteek

---

Flexiteek decking is available on selected models. It features significant advantages over similar wood products. It is made from synthetics. Color is as natural as timber and uniform through the entire thickness adding to its appeal. It sands like wood resulting in a natural wood look and feel. It provides superior grip making it great for boating in general and water sports. It is stain resistant with most stains washing away with soap and water.

The product is UV resistant. Gentle sanding removes most marks on the decking with a minimum of product loss.







## Equipment Operation

---

### Toilet-Chemical

---



Before each outing make sure the chemical toilet is filled with the proper chemicals, paper is available, and if a holding tank is installed make sure it is empty.

To fill the toilet read and follow all the manufacturer's recommendations for mixing the solution. Use the fill to pour in the deodorant chemical and water. By pushing down on the bellows the chemical mix is released to rinse and help flush the toilet bowl. When the flush

valve is pulled forward the toilet bowl waste water empties into the holding tank. Close the flush valve after each use.

The chemical toilet features a holding tank level indicator. When full the lower holding tank must be emptied by first separating it from the upper toilet bowl assembly. Before proceeding, ensure the flush valve is completely closed. Find the latches that allow the 2 units to be separated. Once separated, find an environmentally friendly facility to dispose of the waste.



## CHAPTER 6

---

### Toilet-(Vacuum)Suction Style Flush

---



A suction style flush electric toilet is available on your vessel as optional equipment. This toilet operates in a different way from other marine toilets. The system uses around 16 ounces per liquid or solid flush which is a substantial water savings over other systems.

The toilet is connected to a pressurized fresh water supply tank or to a water strainer and intake seacock. An electrically controlled in-line solenoid valve lets fresh water into the toilet bowl. This unit is outfitted with special valving which prevents the possible contamination of the potable water system. The main components are:

**Fresh Water Storage Tank-** This tank delivers the needed water to the toilet for flushing purposes when connected to a fresh water pump.

**Holding Tank-** Unit features polyethylene composition. A deodorant additive is required to keep the holding tank odor-free. The holding tank is connected to a deck fitting for pump-out purposes.

**Head Wall Switch-** Used to flush waste into the holding tank from the toilet. Normally these switches feature economizer cycles.

**Fresh Water & Waste Monitor-** Select vessels offer a monitor panel to display the fresh water and waste level.

**Overboard Discharge Pump-** An optional pump sometimes called a macerator which vacates waste through the deck waste fitting when a pump out is used. A waste seacock may be installed through the hull as auxiliary equipment (only used beyond the 3 mile limit in the USA in International waters).

**Discharge Check Valve-** Ensures a one-way route for waste to holding tank.



## Equipment Operation

---

The system uses a combination of suction and water flow from the fresh water tank to clear the head of waste.

The system components including the hose are formulated for the transfer of sanitary waste only. Do not allow the following items in the system: Strong acid or caustics such as drain openers, petroleum solvents or fuels, alcohol based products such as antifreeze and pine oil products along with sanitary napkins and baby diapers.

To operate the head;

1. Activate the pressurized fresh water system switch found on the head 12 volt panel by pulling out on the device. The fresh water tank is the water source for the system. See the illustration on the next page.
2. Next, activate the switch located at the head wall to flush liquid or solid waste. The system requires more water for solid over liquid waste. Note the switch control below.
3. Adding water to the toilet is recommended before flushing solid



TYPICAL HEAD WALL SWITCH

waste. Simply press the “add water” button and hold for 1 second. Approximately 17 ounces of water is added to the bowl. There are system electronics that prevent overflow of the bowl.

The flush button is recommended for flushing liquid waste since it saves water and fills up the holding tank at a slower rate. To empty the bowl without adding water or starting a flush sequence, push and hold both buttons together until the bowl contents are discharged. Pushing either button at this point returns toilet flushing to normal operation.



## CHAPTER 6

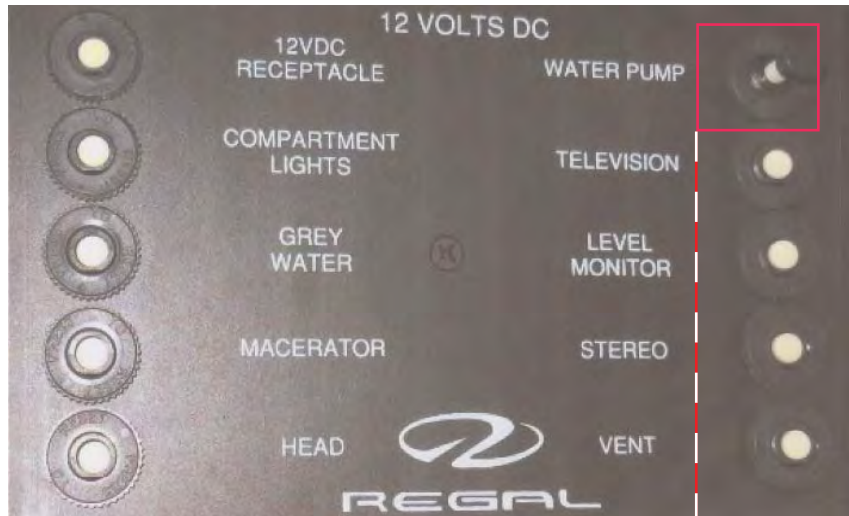

Pull fresh water pressure pump switch to activate unit.

The fresh water pressure pump is protected by a 10 amp breaker.

Additional equipment on the 12 volt panel is protected by individual breakers. If component fails to operate check breaker for “open” breaker position.



## Equipment Operation

---

The holding tank level needs to be monitored periodically for content fullness. Do not operate the waste system when the holding tank is full. Before venturing out on a cruise it is a good idea to have the holding tank pumped out. Normally when the waste tank is overfull it may clog the charcoal vent line filter.

Since a small amount of water usually remains in the holding tank it is a good idea to rinse the tank especially after cleaning. Add water to the toilet bowl along with 8 ounces of manufacturer's tank deodorant and cleaner until the discharge is clear. Do not use chlorine based or caustic cleaners along with drain openers as damage to the seals and hoses may occur.

Rinsing the pump-out hose at the deck fitting with a bit of fresh water should be done after the marina pump-out equipment hose is removed. This prevents a build up of particles and tissue on the waste hose.



TO CHANGE FILTER, UNSCREW UNIONS

On electric toilet installations a waste filter is connected between the overboard hull vent and the waste tank. It eliminates the majority of the ingredients that cause waste system odor. It is recommended that this filter be changed once per year. Refer to the toilet operation manual for further information.



## CHAPTER 6

### Toilet-Electric w/Overboard Discharge Pump

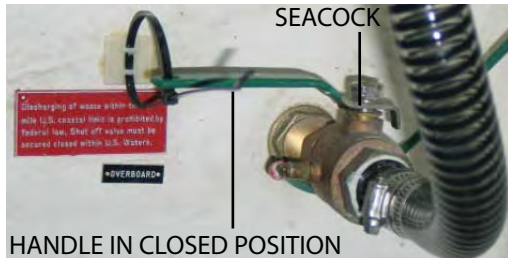

Federal regulations prohibit pumping waste overboard within the territorial limits of the United States. Check with authorities regarding specific laws and regulations before attempting to pump waste overboard.

1. Locate the seacock. Remove the locking mechanism from the seacock and turn the valve to the “open” position by aligning the seacock handle with the valve.



2. The overboard pump uses an enhanced monitor panel with a built-in key switch located in the head compartment. To activate the macerator pump turn the switch on and completely to the right. At this point the macerator pump will sound starting the pump out process. It will be required to hold the switch to the right until the tank is emptied. Once empty return the key switch to the “off” position. Have someone monitor the waste tank level visually during the pump out process. Avoid running the discharge pump “dry”.



## Equipment Operation

---

### Toilet-Electric w/Pump Out Fittings

---



As an option electric toilets feature a deck fitting that permits a marina or waste station to pump out the vessel waste or holding tank. A hose attachment screws into the deck fitting and removes the waste in the vessel toilet holding tank by activating a land pump.

After the pump-out procedure rinse the waste hose briefly to eliminate a build-up of debris and odor before closing the pump-out deck fitting.

Read the manufacturer's recommendations regarding toilet paper type since household varieties are not usually "friendly" to the onboard system or the marine environment.

As part of your pre-cruise inspection monitor the waste tank level and obtain a pump out before undertaking any extended day cruising.



## CHAPTER 6

### Trim Tabs



—PORT ROCKER

—STBD. ROCKER

TRIM TAB SWITCH



If installed, trim tabs are located on the lower hull of the transom. Water is deflected and redirected as the trim tabs are raised and lowered from the starboard helm located trim tab switch. This change in water flow creates upper pressure under the tabs, and raises the stern. When the stern rises, the bow is lowered. Lowering the port tab will cause the port stern to rise, making the starboard bow lower. Lowering the starboard tab will cause the starboard stern to rise, making the port bow lower. The pressure originates from a pump and valve system at the aft bilge.

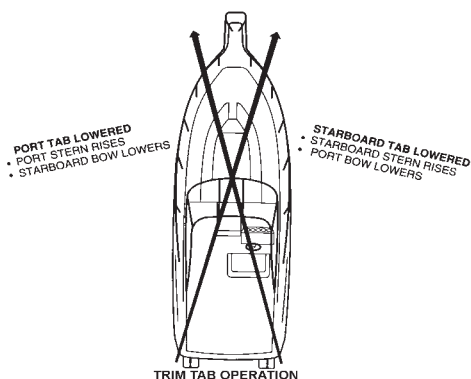

Using trim tabs in conjunction with the power trim will compensate for uneven weight distribution, listing, water conditions, and other factors that cause inefficient operation. Remember, that trim tabs are trimming the hull while power trim is trimming the engine drive.





## Equipment Operation

---

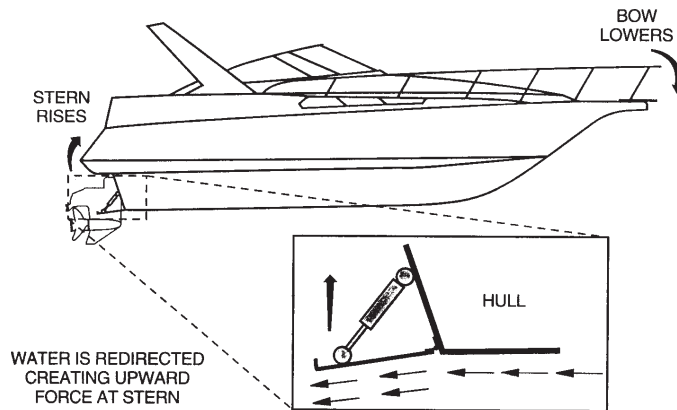

### Obtaining A Trimmed Position

Your vessel will reach a planing position at a specific speed. This speed is determined by bottom design, weight distribution, water conditions, and on board equipment. As the throttle is advanced the stern squats and the bow rises initially. The trim tabs allow your boat to plane at a slower speed than natural conditions allow.

In short bursts both trim tab rocker switches are pushed simultaneously in the “bow down” position which causes the trim tabs to move down. As the boat breaks over the bow high attitude the boat speed accelerates and visibility increases.

If the boat is over-trimmed, it will plow the bow and the boat will lose maneuverability. If this occurs, simply short burst the “bow up” trim tab rocker switches simultaneously.

In the “learning curve” process, press the tab switches in half second bursts. You will notice a slight delay from the time the switches are pushed until the boat reacts depending on vessel speed. You will know after awhile the optimum planing angle and speed.

When running in heavy seas press the “bow down” position which will assist the vessel to cut through the waves. This will produce a drier and more comfortable ride. In a following sea run the tabs in a fully retracted angle for maximum stern drive response.



## CHAPTER 6

Sometimes you can watch the bow spray or stern wake and the rooster tail (mound of water produced by stern drives). In a bow up position the spray is far aft to the hull, the wake is high and the rooster tail is high.

When trimmed or in the bow down position, the bow spray is farther forward, the wake and rooster tail are smaller, and positioned further behind the vessel. Also, when trimmed you will notice that the tachometers show an increase in rpm's.

### Rectifying A List

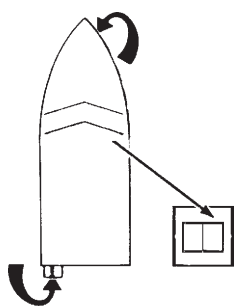

Your vessel can use the trim tabs to rectify a list. The trim tabs adjust the boat's attitude in the direction the helm rocker switch is pushed.

If the port bow is high, push the left-hand "bow down" direction on the dash rocker and the port bow will lower. If the starboard bow is high, push the right-hand "bow down" direction and the starboard bow is lowered.

### Using Stern Drive Power Trim With Trim Tabs

#### TRIM TABS WITH POWER TRIM

- Trim Tabs Trim Hull
- Power Trim Trims Prop

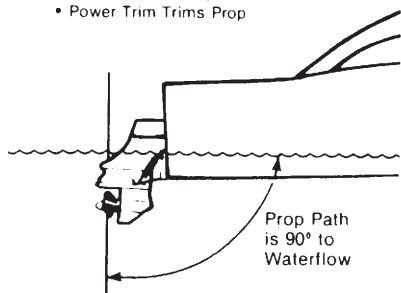

Adjust the trim tabs to achieve a planing attitude. Use the power trim to position the prop path parallel to the water flow. At this point the trim tabs may need a fine adjustment.

One advantage of the trim tab system is that they allow trimming of the hull while the power trim results in trimming the props.



## Equipment Operation

---

### Porpoising

Porpoising is a running condition where the bow “bounces” up and down similar to a porpoise’s swimming motion. This condition is normally caused by the trim being too far “up” as indicated on the trim gauge. Press “bow down” in one-half second bursts and the porpoising should recede and the vessel speed should increase. Only a small amount of “bow down tab” is normally necessary to make the vessel bow actually go down.

### Trim Tab Indicators



Optional trim tab indicators feature port and starboard icons. As the tabs move up or down through the activation of the switches, indicators illuminate the appropriate directional lighting icons. It eliminates the task of constantly trying to figure out the tab position. Makes it easy to reset the tabs for a balanced initial “down” or “in” take-off position. By monitoring the icon position the operator can help eliminate an over tabbed position that can cause porpoising and other unsafe bow positions.



## CHAPTER 6

---

### Underwater Lights

---



As an option light bars w/ sealed LED bulbs make up the underwater lighting system. The lights are located on the transom. There is a dash switch for energizing the lights. The underwater lights circuit protection fuse is found at the helm breaker panel fuse block

and is rated at 10 amps. Your lights may display a different footprint.



Typical Underwater Lighting



## *Equipment Operation*

---

### **Water Heater**

---

As an option, a water heater may be installed on your vessel. The water heater uses engine warmed water routed through a core unit to heat the water in the unit itself. There is a shower head with hot and cold water choices. The water heater capacity is 3 gallons. See the water heater owner's manual for additional information.



## CHAPTER 6

---

### Windshield

---



The typical windshield features tempered marine safety glass. The unit is tinted to reduce glare and features a seal to deflect water. The windshield is supported by a port and starboard brace. Periodically check brace hardware tightness. The center windshield opens for bow access. When the vessel is in motion ensure that both windshield latches (located at the center windshield track opposite the hinged side) are in the locked mode. **Never leave the center windshield open when the vessel is in motion as personal injury and/or property damage may occur.** When cleaning the glass do not use products with ammonia as it causes corrosion and can damage the metal extrusion finish. Keep the windshield clean for optimum operator visibility.

### Windshield Wiper

---

A starboard wiper option is available. Do not operate wiper on dry glass. Periodically check all hardware for tightness and wear.



---

# *Cosmetic Care & Maintenance*

## **COSMETIC CARE**

This section covers the care of your boat. Many cosmetic care topics including exterior hardware, upholstery, fiberglass and canvas are covered along with major equipment and systems. As always, refer to the owner's information packet and the appropriate engine manufacturer's owner's manuals for further detailed instructions.

### **Upholstery**

---

Cockpit and interior vinyl require periodic cleaning to maintain a neat appearance and to prevent the build up of dirt, mildew and contaminants that may stain and reduce the vinyl life if they are not removed. The frequency of cleaning depends on the amount of use and conditions to which the vinyl is subjected.

Most common stains can be cleaned using warm, soapy water and clear rinses. Scrubbing with a soft bristle brush will help loosen soiled material from embossed surfaces and under welting. If the stains are not removed with the above method use a mild cleaner such as Fantastic. This cleaner should be used only as needed and not the normal means.

With more stubborn stains, rubbing alcohol or mineral spirits may be tried cautiously. Widespread solvent use can severely damage or discolor vinyl. Try to remove stains immediately before they have a chance to penetrate the surface of the vinyl.



## CHAPTER 7

---

Powdered abrasives, steel wool, or industrial strength cleaners are not recommended for cleaning our vinyl. Lacquer solvents will cause immediate damage. Dilute chlorine bleach before using. Do not wax the vinyl as it may cause cracking. Always wear protective gloves and make sure there is sufficient ventilation when cleaning vinyl. Wear eye protection.

Remember that suntan oil will damage vinyl. Use suntan lotion instead of suntan oil. Exposure to the sun is a natural enemy of vinyl upholstery. Keep the vessel covered with a cockpit cover when not in use.

### Cockpit Carpet

---



To keep your carpet at its best, use a vacuum for regular cleaning. For hard to remove spots, use soap and water along with an approved cleaner for deep cleansing. Always try on a test area first. Many spots and spills can be removed using

a cleaner combined with a clean, white terry towel. Stains should be removed as soon as possible, as this enhances the ability to remove a stain. If the stain persists, the cleaning procedure should be repeated to ensure stain removal. Try not to soak an area excessively and do not use solvents because most interior carpet is rubber backed and glued in place. Solvents and abrasives will break down the backing and fibers.

**Note: Always roll up cockpit carpet before storing your boat for extended periods. Store carpet in a dry locker.**





## *Cosmetic Care & Maintenance*

---

### Plastics

---

Use plastic cleaners and polishes recommended for marine use only. Use proper applicators. Read all instructions carefully. Test the product in a small area first. Use a soft rag and always rinse the surface with water. Ammonia based cleaners and abrasives will damage plastic parts.

### **NOTICE**

**NEVER CLEAN PLASTIC SURFACES WITH A DRY CLOTH OR GLASS CLEANING SOLUTIONS CONTAINING AMMONIA. NEVER USE SOLVENTS OR WIPE WITH ABRASIVES**



## CHAPTER 7

---

### Interior Fabrics

---

Clean flat good interior fabrics with dry cleaning fluid style cleaners approved for use with soft fabrics. Allow adequate ventilation and follow the label instructions carefully. Normal interior vinyl such as used on the headliner on cruisers and head clean up with a mild soap and water solution. Rinse immediately with clean water and wipe dry. Always test an area with a cleaner before applying it to a larger area.

### Fiberglass & Gelcoat

---



## CAUTION

AVOID BODILY INJURY!  
WAXED GELCOAT SURFACES  
CAN BE VERY SLIPPERY.  
DO NOT WAX NORMALLY USED AREAS  
OF THE DECK, LINER, OR GUNWALES.  
DO NOT WAX ANY TEXTURED  
OR NONSKID SURFACES  
SUCH AS FLOORS, WALKWAYS,  
STEPS, LADDERS OR SWIM PLATFORMS.  
WEAR NON-SLIP FOOTWEAR WHEN WALKING  
ON VESSEL SURFACES.

Routine maintenance is the only practical way to keep the surface of your boat looking shiny and new. Most objects left outdoors will gradually deteriorate from exposure to the sun, water, dust and pollution. Such outdoor exposure can cause your boat's gelcoat surface to change or fade. Darker colors tend to fade more rapidly than lighter colors because they absorb more of the sun's rays (ultraviolet and infrared). Basic maintenance includes monthly washing of the boat's surface to remove normal accumulation of soil and stain.



## Cosmetic Care & Maintenance

---

Use a mild detergent such as dishwasher powder or liquid. Do not use automatic dishwasher detergent. Avoid any kind of alkaline cleaners such as trisodium phosphate (TSP), abrasives, bleaches and ammonia. For best results use cleaners that are recommended for fiberglass.

### NOTICE

WIRE BRUSHES, SCOURING PADS, OR OTHER ABRASIVE TYPE MATERIALS AND SOLUTIONS SHOULD NEVER BE USED ON THE HULL OR DECK OF YOUR BOAT. THEY CREATE SMALL SCRATCH MARKS THAT WILL COLLECT MARINE GROWTH AND OTHER FOREIGN MATERIALS.

It is recommended that you wax the gelcoat surface twice yearly to prevent loss of gloss and to protect the finish. Use only waxes for fiberglass and follow the label instructions. Apply a 3' x 3' section at a time using clean applicator cloths or a buffing bonnet. When a haze develops, use a power buffer at low speeds (1200-2000 rpm) to remove the haze. Keep the buffer moving to avoid heat buildup. The power buffer is very efficient at removing contaminants from gelcoat. Never wax gelcoat in the direct sun.

When the washing and waxing as recommended does not restore the shine it may be necessary to use a fine rubbing compound. Do not apply rubbing compound in direct sunlight. A power buffer at low speed does an excellent job to remove impurities from the gel coat that cause dulling. Use light pressure and keep the buffer moving. Re-wax after compounding to buff the surface.

“Hairline cracks” or “spider webbing” could develop in the gelcoat surface of a hull or deck. This can be caused by impact or other factors. Small air pockets or gouges may also occur through **normal** wear.



## CHAPTER 7

---

These do not affect the strength of the hull or deck and can be repaired by yourself, a marine professional or a Regal dealer.

The affected area should be chipped or sanded away and a thin layer of color matched gelcoat applied. This layer is then sanded smooth and buffed to its original luster.

Most minor scratches, nicks, and dents can be removed by compounding the surface. Marine type compounds can be found at most auto body supply stores. Specify a number 25 which is a coarser compound up to a number 55 being less coarse. Various glazes and polishes are available as needed. Ask your marine professional or Regal dealer for more information. Fiberglass hulls are strong but they can be damaged. A fiberglass hull has virtually no internal stresses. Thus when a part is broken or punctured, the rest of the hull retains its original shape. A severe blow will either be absorbed or result in a definite localized break. A break of this nature should be checked and repaired by a marine professional or a Regal dealer.

### Minor Repairs

---

You will need the following materials for minor repairs:

- Gelcoat
- Clear Liquid Catalyst
- Putty Knife
- Razor Blade
- Fine Sandpaper (400,600,1000)
- Wax Paper (to cover repair area)



## WARNING

AVOID BODILY INJURY!  
GELCOAT & FIBERGLASS RESIN ARE FLAMMABLE.  
WORK IN A WELL VENTILATED AREA FREE FROM  
OPEN FLAMES. DO NOT SMOKE!



## *Cosmetic Care & Maintenance*

---

For minor repairs refer to the following procedure:

1. Clean the area to be repaired and get rid of any wax or grease residues.
2. Clean out scratches, chips, and nicks.
3. Sand area to be repaired so gelcoat will bond.
4. In a separate container, measure only the amount of gelcoat you will need. Mix a ratio of 2% ratio of catalyst to the amount of gelcoat being used (a spoonful of gelcoat will require only a drop or two of catalyst). Do not pour any unused portions of the gelcoat/catalyst mixture back into either original container.
5. Apply gelcoat to area leaving a slight lift above the surface.
6. Cover the area with wax paper. It will help the mixture to set up faster.
7. Remove wax paper and shave off any extra gelcoat with a razor blade.
8. After the area is shaved smooth, start with the 400, 600, and finally 1000 grit sand papers.
9. Buff the area with compound, polish and a finish wax. You may notice a difference between the repaired area and the original finish due to the natural weathering process.

### **Canvas**

---

Boat canvas is in most cases subjected to more severe punishment than practically any other type of material. Moisture, dirt and chemicals from industrial fallout, heat, ultraviolet rays and salt water are all factors which accelerate the deterioration of your boat canvas.



## CHAPTER 7

---

These elements can cause serious damage if left unchecked.

The boat top and other canvas supplied on your Regal boat are manufactured from top quality materials to provide you with years of trouble free service. The following information on the care, cleaning and proper storage of the fabrics and fasteners that make up your marine canvas is being provided to help you maintain the appearance and ease of operation.

Sunbrella is used on most Regal tops, aft curtains, camper enclosures, bow tonneaus and cockpit covers. Sunbrella is a woven fabric made from 100% solution dyed acrylic fiber. It is color fast and will withstand long term exposure to the sun (ultraviolet rays) without excessive fading.

Sunbrella is a woven fabric. Even though it is treated with water repellency some “misting” through the fabric is typical. With new canvas, the greatest potential for leakage is through the sewn seams. Because Sunbrella and the long term thread used is synthetic, the holes created by sewing will not swell up and seal when exposed to water as cotton does. Usually the movement of the fabric in use will move the fibers enough to seal the holes. You may apply Apeal or Uniseal to the seams to speed up this process.

When the canvas is new, the fit will normally be tight. It is designed this way because the fabric stretches as it ages, The initial tight fit allows for a suitable footprint for the life of the canvas. Any fabric fit will vary slightly in the heat, cold, and rain.

### **Sunbrella Cleaning Instructions**

---

Sunbrella should be cleaned regularly before substances such as dirt, roof particles, etc., are allowed to accumulate on and become embedded in the fabric. The fabric can be cleaned without being removed from the boat. Simply brush off any loose dirt, hose down, and clean with a mild solution of natural soap in lukewarm water. Rinse thoroughly to remove soap. **DO NOT USE DETERGENTS!** Allow to air dry. For heavily soiled fabric, remove the top from the frame.



## *Cosmetic Care & Maintenance*

---

Soak the fabric in a solution that has been mixed to the following proportions: 1/2 cup of bleach and 1/4 cup of Ivory or Lux soap (liquid or soap) per each gallon of lukewarm water. Allow the fabric to soak until the bleach has killed the mildew and the stains can be brushed out with a common kitchen scrub brush. Rinse the fabric thoroughly in cold water to remove all the soap. This may require several rinsings. Incomplete rinsing can cause deterioration of sewing threads and prohibit the fabric from being properly retreated. Allow the fabric to dry completely. **DO NOT STEAM PRESS OR DRY IN AN ELECTRIC OR GAS DRYER!** Excessive heat can damage and shrink the fabric since it is heat sensitive.

This method of cleaning may remove part of the water and stain repellent that was applied to the fabric during its manufacture. It is recommended to retreat with such water repellency products as Apeal and Uniseal. We do not recommend any wax based treatments such as Thompson's Water Seal or any of the silicone products such as SC-15 or Aqua-Tite. Wax based products prevent the fabric from breathing, and encourage mildew growth while the silicone products interact with the original fluorocarbon finish and seem to cause a rapid loss of water repellency.

### **Clear Vinyl, Zipper & Snap Care** ---

Never store canvas wet or in an unventilated, moist area. Always roll the canvas instead of folding. This is of particular importance on side curtains or any other part with the clear vinyl "glass". Roll the top carefully around the bows and cover with the storage boot provided. The clear vinyl "glass" used in side curtains, aft curtains, visors, and camper enclosures is very susceptible to heat and cold. Keep vinyl curtains from touching metal tubing to minimize burning the vinyl. If the boat is stored with top, side curtains and aft curtain in place, heat build up inside the boat may discolor the vinyl.

To clean the clear "vinyl" glass, use a solution of Ivory or Lux soap, liquid or flakes, and lukewarm water. Allow to air dry. Never use any



## CHAPTER 7

---

type of abrasive cleaner as it will scratch the “vinyl” glass. There are many cleaners and scratch removers on the market specifically for clear vinyl. Handle the clear curtains carefully. They are soft and prone to scratching.

Canvas parts are designed with zippers. When zippers are new they can be a little difficult to use. Zip carefully without forcing the zipper or the material. They will loosen with use. A zipper lubricant may be used to help new zippers as well as maintaining used ones. The most vulnerable part of the zipper is the starts. Use care when beginning to close the zipper.

Canvas snap fasteners should be unsnapped as close to the button as possible. Never remove canvas by pulling roughly on the edge of the material. This can damage the canvas as well as the fasteners. Use petroleum jelly on snaps to keep them from developing corrosion especially in harsh environments.

### **Metal**

---

Keep all stainless steel and other metal parts rinsed and wiped dry. To maintain their finish annually polish the stainless steel and other bright works at least annually. Use commercially available metal products and read the labels carefully before use. Refer to the flyer in the owners information pouch. Most marinas and boating retail outlets carry metal care products.

### **Hull Bottom**

---

Never use wire brushes or highly abrasive scouring pads on your hull bottom. It could damage the gelcoat surface or the bottom paint. The bottom of your boat needs to be clean since the build up of natural coatings from water or marine life can potentially create drag and affect your boat’s performance. Contact a marine professional or Regal dealer for more information.





## Cosmetic Care & Maintenance

FREQUENT STAINS/CLEAN-UP STEPS	1	2	3
Coffee, Tea, Chocolate.....	B		
Permanent Marker*.....	E	B	C
Household Dirt.....	A	B	
Grease.....	D	B	
Ketchup, Tomato Products.....	A	B	
Latex Paint.....	A	B	
Oil Base Paint.....	D	B	
Mustard.....	A	B	C
Suntan Oil.....	A	B	
Asphalt/Road Tar.....	D	B	
Crayon.....	D	B	
Engine Oil.....	B		
Spray Paint.....	B		
Chewing Gum.....	D	A	
Shoe Polish*.....	D	B	
Ballpoint Pen*.....	E	B	A
Lipstick.....	A	B	
Eyeshadow.....	E	B	
Mildew*.....	C	B	A
Wet Leaves *.....	C	B	A

A= Soft brush; warm soapy water/rinse/dry

B= Fantastik cleaner

C= One tablespoon ammonia, 1/4 cup of hydrogen peroxide, 3/4 cup of warm water/rinse/dry

D= Scrape off residue (use ice to lift gum)

E= Denatured alcohol/rinse/dry

\* These products contain dyes which leave permanent stains.

## CHAPTER 7

---

### MAINTENANCE

#### Automatic Fire Extinguisher ---



If installed the automatic fire extinguisher system should be checked for tightness at the engine compartment monthly. At that time the unit itself should be weighed to ensure it is full.

If the green dash indicator light is not on when the key is in the ignition position there is a system malfunction that must be investigated immediately. Refer to the operator's manual in the owner's packet.



## Cosmetic Care & Maintenance

---

### Battery System

---



Frequently check your battery terminals for corrosion build-up. If you find a greenish, powdery substance, remove the cable connections and clean both the terminals and the connectors with a wire brush. When the cleaning is finished reconnect the battery cables and coat the terminal with an approved grease or petroleum jelly to help prevent further corrosion. Check the electrolyte level at least every 30 days, more often in hot weather. The level should be maintained between the top of the battery plates and the bottom of the fill cap opening. Add distilled water as needed after charging the batteries or periodically as needed. Do not overfill as sulfuric acid could run over and cause burns or an explosion.



Batteries should be charged outside the boat. Do not smoke or bring flames near a battery that is being or has recently been charged. The hydrogen gas generated by battery charging is highly explosive.

Set batteries on a block of wood rather than concrete since this procedure will help the batteries from losing their charge.

Do not allow metal objects such as tools or loose wires to spark across battery posts while working close to the battery. Contact across terminals will may cause component damage and/or personal injury.

Tighten all battery connectors securely. Check their tightness by pulling on the connectors. They should not move from their tightened position. Be sure to reinstall the positive boot over the battery terminal after tightening the battery post connection. While using the boat, use the volt meter to monitor the charge level of the battery. Monitor the charge with the engines turned off (static condition).

The engine alternators recharge the batteries. A fully charged battery will indicate between 12.3 and 12.6 volts on the voltmeter. Readings below this could indicate a dead battery cell or a charging system malfunction which should be checked by a marine professional.



## CHAPTER 7

---



### **WARNING**

BATTERIES CONTAIN SULFURIC ACID (POISON)  
WHICH ALSO CAN CAUSE BURNS.  
AVOID CONTACT WITH THE SKIN, EYES & CLOTHING.  
IF CONTACTED, FLUSH WITH WATER AT LEAST 15  
MINUTES. IF SWALLOWED, DRINK LARGE AMOUNTS  
OF WATER OR MILK. FOLLOW UP WITH MILK OF  
MAGNESIA, BEATEN EGG OR VEGETABLE OIL. GET  
MEDICAL ATTENTION IMMEDIATELY!



### **WARNING**

TO PREVENT BODILY INJURY!  
WEAR GOGGLES, RUBBER GLOVES  
AND A PROTECTIVE APRON  
WHEN WORKING WITH A BATTERY.  
BATTERY ELECTROLYTE CAUSES SEVERE EYE  
DAMAGE AND SKIN BURNS.  
IN CASE OF SPILLAGE, WASH AREA WITH  
A SOLUTION OF BAKING SODA AND WATER.



## *Cosmetic Care & Maintenance*

---

### **Battery Charger**

---

If installed the battery charger system requires a **monthly** inspection. Follow the information below to keep the battery charger and related components in top working order.

1. Remove all battery hardware and clean all battery connections with a wire brush. Baking soda and water are great for removing built up oxidation. Reinstall all battery connectors, tighten and lubricate with dielectric grease.
2. Per battery manufacturer maintain the electrolyte cell levels by adding distilled water. Do not use tap water since minerals can cause cell corrosion.
3. Check all wiring for abrasions and cuts.
4. Inspect the extension cord for a missing ground blade.
5. Check the plug. Make sure the cover closes to assure a watertight connection.



## CHAPTER 7

### Bilge Pump

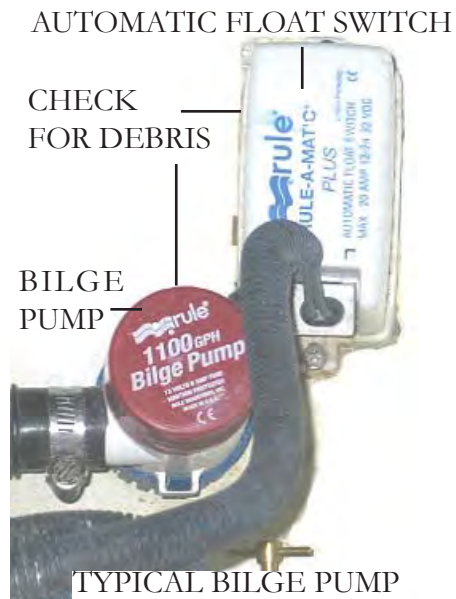

A bilge pump is installed in the engine compartment just below the engine front. Its primary task is to pump overboard any accumulated bilge water.

Periodically check the following:

1. Check for foreign materials stuck in the strainer area or discharge hose.
2. Check all clamps and electrical connections for tightness. A quick check of the bilge pump automatic

float switch when installed is afforded by lifting the float portion and listening for the pump operation. Look around the float area for foreign debris and remove as necessary.

It may sometimes become necessary to replace the bilge pump impeller. Unfasten the bilge pump housing from the unit by pressing on the quick release tabs on the grate and pulling up, similar to a quick disconnect clip on a backpack. Remove the o-ring and access the impeller. Remove any debris lodged in the impeller and replace if fractured in any form. The bilge pump impeller should be changed as needed or it may be more advantageous to change the entire bilge pump component.



## Cosmetic Care & Maintenance

---

### Blower

---

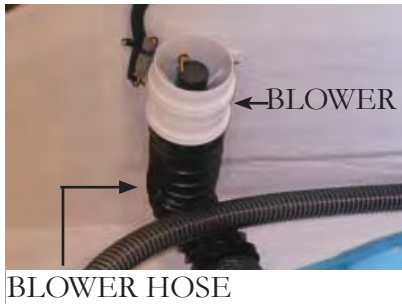

Check the blower hoses to ensure they are fastened in the bilge properly and there are no holes in them. The ventilation hose connected to the blower needs to be positioned about 3/4 of the way down in the bilge to evacuate fumes properly. All vents need to be checked for debris.

Make sure the blower motor is securely fastened and all hose clamps and or tie wraps are tight. Periodically, check all electrical eyelet connectors for tightness.



## CHAPTER 7

---

### Fuel Tank & Fittings

---

Periodically inspect the fuel tank components for loose clamps at the vent including the charcoal canister, fill, and feed locations. Examine each hose for signs of deterioration and leakage. Check the fuel sender for loose bolts, nuts, and leaks at all areas of contact. Also, inspect the fuel tank for signs of stress, leakage or abrasion. Tighten all components as needed. **Inspect entire fuel system at least once per year.**

#### TYPICAL EPA COMPLIANT FUEL TANK



CARBON CANISTER

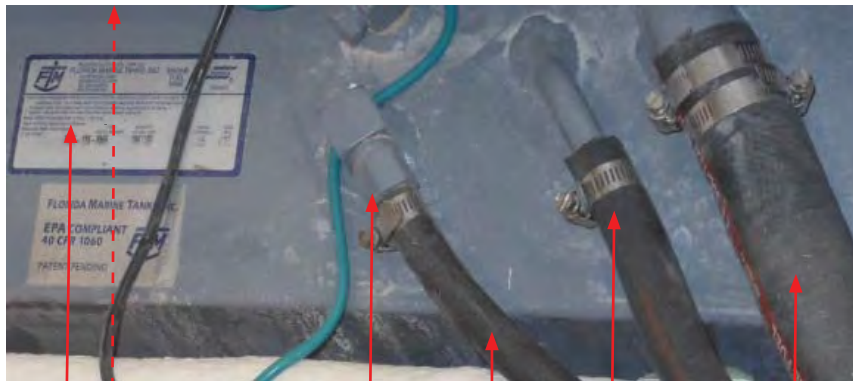

ANTI-SIPHON VALVE

FUEL VENT

FUEL SENDER

FUEL FEED

FUEL FILL

LABEL





## Cosmetic Care & Maintenance

### Galvanic/Stray Current Corrosion

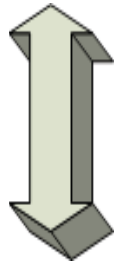
CORROSION TABLE	
Gold	<p>Least Active</p>  <p>Most Active</p>
Stainless Steel	
Bronze	
Copper	
Brass	
Steel	
Aluminum	
Zinc	
Magnesium	

Metal parts underwater can be subjected to two basic styles of electrolysis: galvanic corrosion and stray current corrosion. Both can damage the drive, propeller, underwater parts, boat and motor if not correctly monitored (testing at 2 week intervals) and avoided.

Galvanic corrosion is an electrochemical reaction between two or more metals. Drive systems consist of several different metals. Some are more active than others.

Galvanic corrosion of the more chemically active metals can occur whenever two or more dissimilar metals that are “grounded” (connected by actually touching each other, or through a wire or metal part) are immersed in a conductive solution (any material that can conduct electricity). Anything but pure water is conductive. Saltwater, fresh water with a high mineral content and polluted freshwater are highly conductive. Conductivity increases with temperature. That is why Florida boats experience more corrosion than boats in Maine.

Specifically look at a typical marine drive unit with a stainless steel propeller. The aluminum is the more chemically active metal (called the anode) and the stainless steel propeller is the less chemically active metal (called the cathode).



## CHAPTER 7

---

Typically electrons flow from the anode (the aluminum drive unit), through the external conducting path to the cathode (stainless steel propeller). If there is a very large anode connected to a small cathode, the anode will corrode very slowly. If a very large cathode is connected to a small anode, the anode will corrode very quickly. Obviously, if you do not control galvanic corrosion over time the aluminum will corrode away.

The first sign of galvanic corrosion is paint blistering (starting on sharp edges) below the water line- a white powdery substance forms on exposed metal areas such as the stern drive vertical drive or gearcase housing. As the corrosion advances, the exposed metal will become deeply pitted as the metal is actually eaten away.

Another condition which will increase galvanic corrosion is the removal or reduction in surface area of the sacrificial anodes. Never add aftermarket products that are connected to the engine ground such as stainless steel steering aids and trim planes.

Zinc connected to aluminum will form a corrosion cell but the aluminum (drive) becomes the cathode and the zinc (anode) corrodes.

Even though your boat may not have shore power aboard current from nearby vessels with shore power can produce stray current galvanic corrosion. Stray current corrosion occurs when metal with an electrical current flowing into it is immersed in water that is grounded (lake, ocean, pond). The current can leave the metal and flow through the water to ground. This will cause rapid corrosion of the metal at the point where the current leaves.

When a vessel nearby is plugged into shore power, they can potentially tie your aluminum drive unit to their boat via the green grounding shore power lead. Your aluminum drive unit could be the receiving end of a large galvanic cell (a battery) interconnected with nearby vessels or even through the marina's metal structures via their electrical system.



## Cosmetic Care & Maintenance

---

The vessel should be tested every couple of weeks to determine the integrity of the anode protection system. If not installed, Volvo and Mercury offer an optional corrosion protection system that utilizes the anode/cathode theory to assist in offsetting galvanic corrosion. Another way to test the system is to measure the hull potential. This is accomplished by immersing a reference electrode, usually a silver/silver chloride into the water about six inches behind the drive. With leads attached to a digital multi-meter the hull potential is read on the DC scale and compared to recommended specifications for the water body type.

### Tips To Aid In Maintaining Galvanic Integrity

1. *Test the galvanic integrity of your vessel every 2 weeks.* Raise the stern drive and inspect anodes/parts for signs of galvanic corrosion such as blistering drive paint or stray current corrosion or loose fasteners. *Contact your Regal dealer/marine professional where signs of galvanic corrosion exist.*
2. Never paint over anodes as they will become inoperative. Always leave at least one inch between bottom paint and any underwater fitting such as seacocks, swim platform stanchions and all drive and propulsion related underwater parts.
3. Periodically remove vessel from water and clean/pressure wash all out drive, anode and hull bottom areas to remove growth.
4. Ensure vessel is using the correct anode metal for the body of water that it is moored. See the engine/drive manufacturer information packets for more information or contact an authorized dealer.
5. Ensure that the drive is completely “in” down to provide more complete anode protection when vessel is moored.
6. Do not attempt to use magnesium anodes in saltwater. They will provide overprotection.



## CHAPTER 7

7. If marina moored, contact appropriate personnel if signs of galvanic corrosion appear on your drive system. Ask them to check for stray electrical current which may be originating from a nearby vessel's faulty DC wiring or from a marina pier, piling or dock carrying leaking marina ground wiring such as a dockside cord partially submerged.

<b>GALVANIC/STRAY CURRENT CORROSION</b>	
<i>Cause/Observed Condition</i>	<i>Corrective Action</i>
Sacrificial anodes consumed	Replace anodes when 30% consumed
Sacrificial anodes not grounded to drive	Remove anodes, clean contact surface, reinstall, check for continuity
Loss of continuity between underwater parts & ground	Provide good ground connections
Nearby vessel with stray current	Contact appropriate personnel Remove your vessel from water
Paint on drive heavily worn, exposing more metal	Prime and repaint or install additional anodes
Sacrificial anodes painted	Remove paint or replace anodes
Drive tilted/anodes out of water	Leave drive down, install additional anodes below water
Power trim cylinders only corroded	Provide a good ground to drive, all parts must be grounded
Corrosion in area of exhaust outlets	Remove deposits
Corrosion occurring after vessel is removed from saltwater	Wash exterior and flush interior with freshwater
Stainless steel parts corroding	Clean parts, remove foreign material, ensure continuity
Underwater drive parts corroded, sacrificial anodes OK	Oxide film on anode (fresh water only) Replace anode Poor grd. Remove/scrape anode



## Cosmetic Care & Maintenance

Sacrificial zinc anodes are located on the stern drive housing, trim cylinders and/or prop shaft to protect softer metals exposed to the water. Electrolysis attacks the least noble metals first. Because zinc is a less noble metal, it will decompose before other metals. Check these zinc anodes periodically and have them replaced when they are 30% consumed. Notwithstanding, zinc is the most popular metal used to protect parts that are exposed to saltwater, freshwater or brackish water.

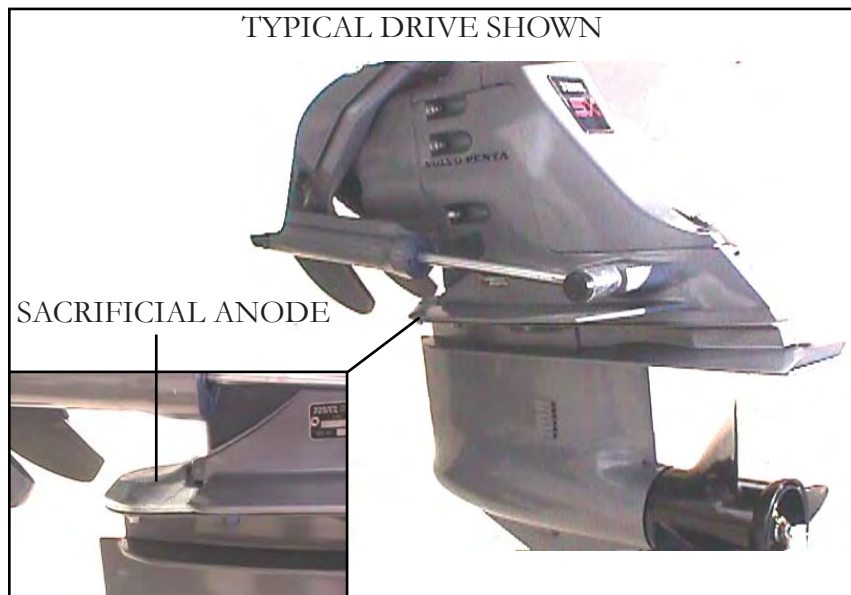

Zinc anodes in brackish or salt water need to be checked more frequently. If the anodes seem to be requiring frequent replacement there may be a boat leaking DC current into the water taxing the anodes. This is especially possible around a marina environment. Contact a marine professional who can measure the galvanic activity with a special electrode and electric VOA meter. Refer to the engine manufacturer's manual for exact anode location and detailed information. **Stern drive or related parts damage due to galvanic or stray current corrosion is not covered under the Regal limited warranty.**



## CHAPTER 7

---

### Propellers

---

Out-of-balance or nicked props will effect performance or cause vibration. Damaged props should be replaced, but those that are chipped or bent can usually be reconditioned by a marine dealer or a propeller repair facility. When cruising, consider carrying a spare set of props on board because many marinas do not carry a full inventory of replacement propellers. Also, carry an extra set of prop hardware. Refer to the manufacturer's engine manual for appropriate stern drive and inboard propeller replacement.

Be sure to make a note of the propeller diameter and pitch while the vessel is in dry dock. They are pressed into the prop for easy reading. In an emergency a stainless steel propeller blade may be straightened by laying the propeller blade on a 2 x 4 and hammering the bent portion of the blade until straight. This procedure may aid the operator in reaching port so he can have the propeller re-pitched.



## Cosmetic Care & Maintenance

### TYPICAL VOLVO DUO PROP INSTALLATION

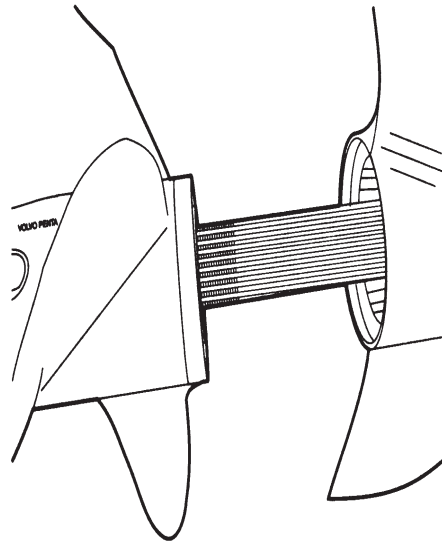

Coat both shafts with marine grease. Place the remote control in forward position to lock shafts. Install the front propeller.

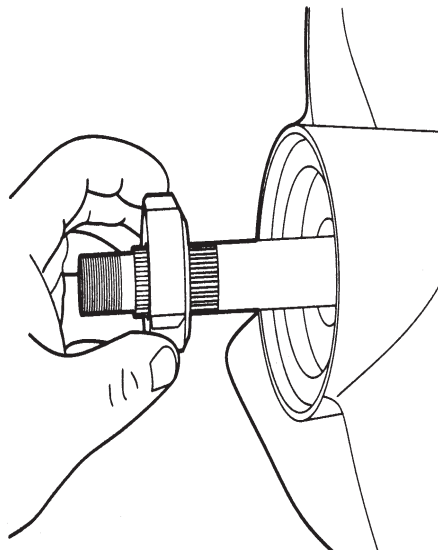

Install propeller nut. Tighten to 45 ft. lbs. Make sure the chamfered edge of the prop nut is facing forward. Failure to install prop nut correctly could result in loss of prop or damage to the lower unit.



## CHAPTER 7

---

### TYPICAL VOLVO DUO PROP INSTALLATION

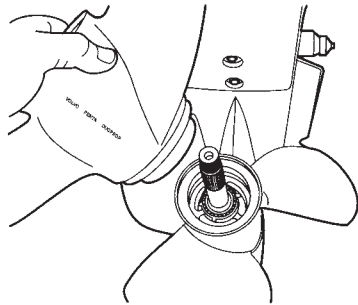

Shift remote control to reverse to lock the propeller shaft. Install the rear propeller.

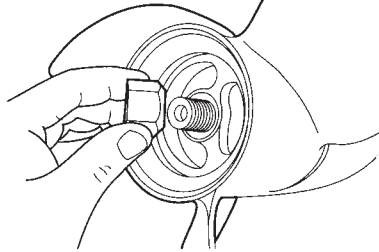

Install the rear propeller nut and tighten it to 50 foot pounds using a torque wrench. Shift the remote control to neutral. The propeller should turn freely.





## Cosmetic Care & Maintenance

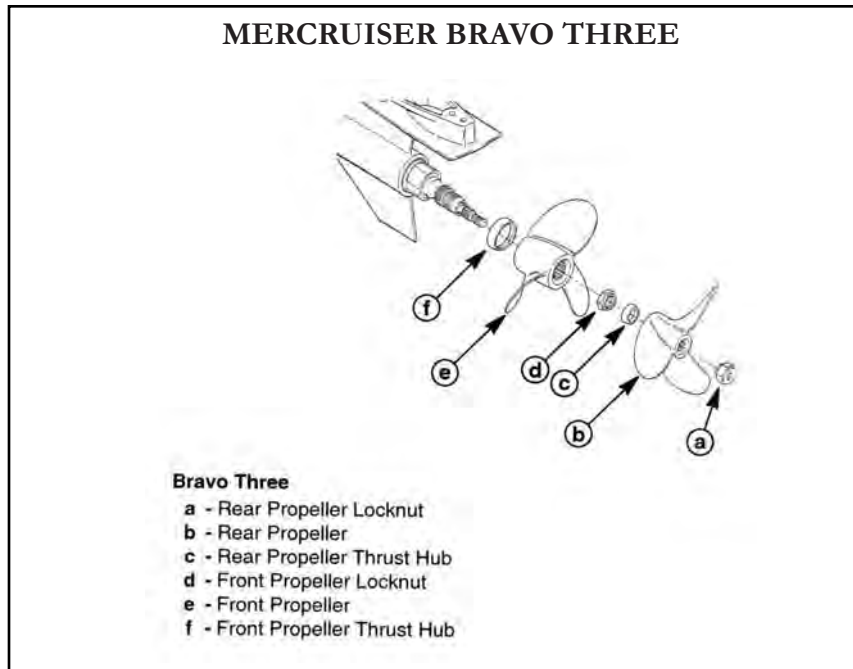

Diagram above displays typical Bravo 3 propeller shaft parts. Refer to the MerCruiser operator's manual for more specific propeller system installation procedures.



## CHAPTER 7

---

### Propulsion Systems (Engines)

---

Each engine and stern drive package is unique and quite complex. A select portion of the maintenance items are covered in this chapter including general lubrication specifications and periodic maintenance. Because of the advanced ignition and fuel injection systems used on marine engines it is best to contact your Regal dealer for more of the detailed service procedures.



### CAUTION

AVOID ENGINE DAMAGE!  
FOLLOW ALL ENGINE BREAK-IN PROCEDURES AS RECOMMENDED BY THE ENGINE MANUFACTURER. FAILURE TO FOLLOW THE BREAK-IN PROCEDURE MAY VOID THE ENGINE AND STERN DRIVE WARRANTY.



### CAUTION

AVOID ENGINE DAMAGE!  
DO NOT RUN ENGINE AT A CONSTANT RPM FOR PROLONGED PERIODS OF TIME DURING BREAK-IN PERIOD. CHECK ENGINE OIL OFTEN.



### CAUTION

AVOID ENGINE DAMAGE!  
DO NOT RUN ENGINE OUT OF WATER UNLESS YOU HAVE AN OPTIONAL FLUSHETTE. FOLLOW MANUFACTURER'S ATTACHING & RUNNING INSTRUCTIONS.



## *Cosmetic Care & Maintenance*

---

### **Volvo Lubrication Information**

---

#### *Changing Typical Volvo Engine Crankcase Oil*

Due to recent EPA mandates on internal combustion engines new domestic engines are built with catalytic convertors installed in the exhaust manifolds, along with a system of sensors and computer controls. These newer engines require special oil requirements to extend the life of the catalyts.

**Refer to the Volvo or MerCruiser engine operator's manual for the correct oil requirements for catalyst type engines, or contact your nearest Regal dealer for further information.**

**For other engines not manufactured as catalyst engines refer to your engine operator's manual for correct oil recommendations.**



## CHAPTER 7

---

### Volvo Engine (Typical)

#### *Checking the Engine Oil*

Before adding oil refer to the Volvo engine operator's manual for oil viscosity and type or contact your closest Regal or Volvo marine authorized dealer.

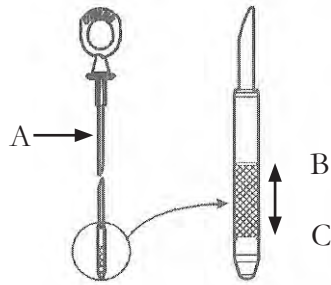

1. To properly check the dipstick (A) oil level run the engine to normal operating temperature and wait about 5 minutes.

2. The oil must be between the B & C marks on the dipstick. Add the recommended oil to maintain the proper level. Make sure you

use the correct oil for non catalyzed or catalyzed engines depending on the age of the vessel.

3. Recheck the engine oil dipstick level.

**Note: Refer to your Volvo engine owner's manual for adding any oil during the break-in period since special blends are required.**

*Note: All fluid recommendations are based on this manual's printing date. Regal is not responsible for the accuracy of the information since it can change at any time. For more detailed information and procedures check your engine operator's manual or contact your closest authorized Regal dealer.*



## Cosmetic Care & Maintenance

### NOTICE

**PREVENT ENGINE DAMAGE!**  
DO NOT ALLOW THE CRANKCASE OIL LEVEL TO RECEDE BELOW THE ADD MARK, AND DO NOT FILL ABOVE THE FULL MARK. OVERFILLING RESULTS IN REDUCED ENGINE LIFE, HIGH OPERATING TEMPERATURES, FOAMING & LOSS OF POWER.

#### *Checking the Power Trim/Tilt Fluid Level*

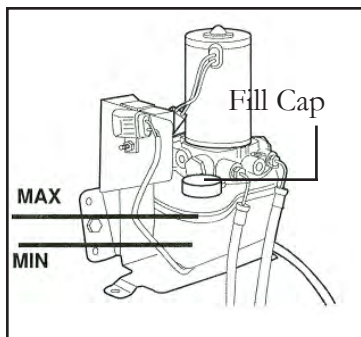

1. At least once annually preferably at the start of the boating season check the system fluid level. Begin with the stern drive trimmed in (down) as far as possible.
2. Remove the fill cap on the power trim pump reservoir.
3. Check the fluid level. It should be between the minimum and maximum marks on the reservoir.
4. Add Volvo Penta DuraPlus Power Trim/Tilt and Steering Fluid as required.
5. Replace the fill cap and tighten cap securely.



## CHAPTER 7

---

### *Checking Typical Volvo Power Steering Fluid*

1. Check the power steering fluid before each boating outing. Remove the steering reservoir and check the fluid level. If the engine has not been running use the “COLD” mark. Use the “HOT” mark for engines that have been running at normal operating temperature as indicated by the temperature gauge.
2. The fluid should be between the minimum and maximum marks on the dipstick. If needed, fill to the proper level with Volvo Penta Dura Plus Power Trim/Tilt & Steering Fluid. **DO NOT OVERFILL THE STEERING PUMP RESERVOIR.**



### **CAUTION**

**PREVENT STEERING OPERATION IMPAIRMENT  
OR COMPONENT DAMAGE!  
NEVER FILL THE POWER STEERING SYSTEM  
WITH AN UNKNOWN OIL.**

3. Replace the fill cap and tighten securely.

### **NOTICE**

**HELPFUL HINT:  
TO FILL TRIM, CRANKCASE & POWER STEERING  
LEVELS WITHOUT SPILLING FLUID  
PURCHASE A FUNNEL AT AN AUTOMOTIVE  
STORE WITH A LONGER NECK THAT WILL FIT THE  
RESERVOIR OPENINGS.**



## *Cosmetic Care & Maintenance*

---

### *Checking Typical Volvo Cooling System*

Your cooling system requires inspection and maintenance with each trip, with extended maintenance every 50 hours. In addition, the water pump impeller needs replacement every two years.

To inspect your cooling system, all lines need to be visually inspected for cracks, melting, crimped spots, and leaks. These lines lead from your raw water intake system to your water pump, which circulates water internally through the engine.

Check the intake and exhausting lines before each voyage. These lines enter your water pump which is normally located on the forward side of your engine near the bottom.

To flush your engine, ensure that the engine is turned off. Then connect a freshwater source to the fresh water port either as part of the engine, or available as an attachment on the stern drive depending on the engine manufacturer. Turn on the freshwater source and turn on your engine. Let the engine run at idle until it reaches normal operating temperature, then shut down the engine, disconnect the hose, and reinstall the cap. Your engine should be flushed after each trip.

To inspect your water pick-up feed, locate the screens on your stern drive unit and remove the debris lodged in the screen. Smaller debris can make its way all the way up to the water pump impeller and build up there, causing malfunction.

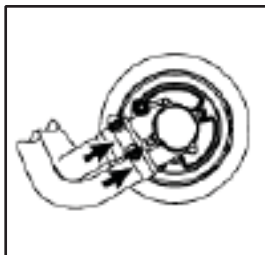

To inspect your water pump impeller, ensure the engine is turned off before locating the water pump housing. Remove the housing to get access to the impeller. Inspect the impeller for nicks, dings, and ease of turning.



## CHAPTER 7

### MerCruiser Typical Lubrication Information

#### *Checking Typical MerCruiser Engine Crankcase Oil*

1. Before adding oil make sure it is the type recommended for the type of engine installed. Consult your MerCruiser engine operator's manual. Check the engine oil by first allowing the engine to warm up. Stop the engine and allow about 5 minutes for the oil to drain to the oil pan to obtain an accurate reading.

2. Remove the dipstick. Wipe it clean and reinstall it into the dipstick

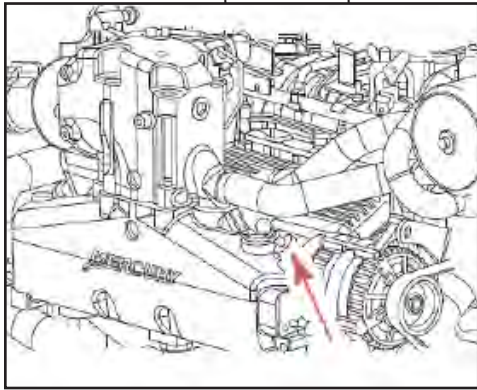

tube. Wait 1 minute to allow any trapped air to vent. ( Install dipstick with oil indication marks facing the flywheel end of the engine. Add engine oil type and viscosity as recommended in the engine operator's manual. to the full or OK points on the oil dipstick.

**DO NOT OVERFILL!**

3. Remove the dipstick and look at the oil level. Level must be between full or OK range and add. Reinstall dipstick into the tube.

4. Mercury systems often have a dipstick mounted on the bottom of the engine and normally identify oil dipsticks or fill caps with a yellow color.

For changing the engine oil & filter see the MerCruiser maintenance schedule and operation manual or contact your Regal dealer.

*Note: Above are basic recommendations. Regal is not responsible for the accuracy of the information since it can change at any time. For more detailed information and procedures check your engine operators manual or call your closest Regal dealer.*





## *Cosmetic Care & Maintenance*

---

### *Changing Typical MerCruiser Engine Crankcase Oil*

Due to recent EPA mandates on internal combustion engines new units are built with catalytic convertors installed in the exhaust manifolds, along with a system of sensors and computer controls. These newer engines require special oil requirements to extend the life of the catalysts.

**Refer to the MerCruiser engine operator's manual for the correct oil requirements for catalyst type engines, or contact your nearest Regal or MerCruiser dealer for further information.**

**For other engines not manufactured as catalyst engines refer to your engine operator's manual for correct oil recommendations.**



## CHAPTER 7

### *Checking Typical MerCruiser Power Steering Fluid*

1. Stop the engine and center the stern drive unit.
2. Remove the combo fill cap/dipstick and observe the level.
  - a. Proper fluid level with engine at normal operating temperature should be within the warm range.
  - b. Proper fluid level with engine cold should be within cold range.
3. Fill to line with Quicksilver Power Trim & Steering Fluid (Merc # 92-802880A1) or Dextron III automatic transmission fluid. If you can not see any fluid in the power steering reservoir contact your Regal dealer since a leak must of developed in the system.

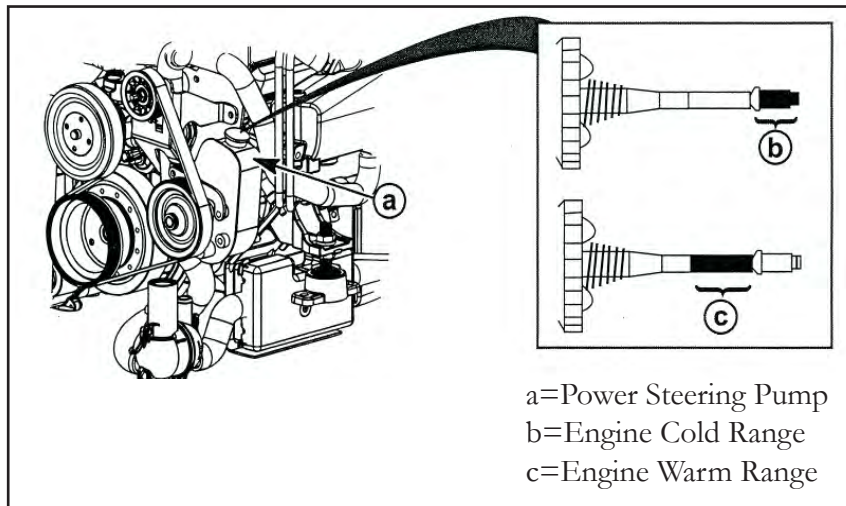



## Cosmetic Care & Maintenance

---

### *Checking Typical MerCruiser Power Trim Fluid*

	<b>CAUTION</b>
<b>ALWAYS CHECK THE OIL LEVEL WITH THE STERN DRIVE IN THE “FULL” DOWN OR “IN” POSITION.</b>	

1. Place the stern drive unit in the full down position.
2. Observe the oil level. Level must be between the “MIN” or “MAX” lines on the reservoir.
3. Fill as necessary with Power Trim & Steering Fluid (Merc part # 92-802880A1).

### *Refilling The Reservoir*

1. Remove the fill cap from the reservoir. Fill cap is vented.
2. Add lubricant to bring level to the within the “MIN” and “MAX” lines on the reservoir. Use Power Trim & Steering Fluid (92- 802880A1).
3. Install the cap.

### *Changing Power Trim Fluid*

1. Power steering fluid does not require changing unless it becomes contaminated with water or debris. Contact a Regal dealer to change the fluid.



## CHAPTER 7

### *Checking Typical MerCruiser Engine Coolant*



## WARNING

**AVOID BODILY INJURY!**  
ALLOW ENGINE TO COOL DOWN BEFORE REMOVING THE COOLANT PRESSURE CAP. A SUDDEN LOSS OF PRESSURE COULD CAUSE HOT COOLANT TO BOIL AND DISCHARGE VIOLENTLY. AFTER THE ENGINE HAS COOLED, TURN THE CAP 1/4 TURN TO ALLOW PRESSURE TO ESCAPE SLOWLY, THEN PUSH DOWN AND TURN THE CAP COMPLETELY OFF.

1. Remove the cap from the heat exchanger and observe the level of the fluid.
2. The coolant level in the heat exchanger should be at the bottom of the filler neck. A low coolant level means you should contact your Regal dealer.
3. Install the cap onto the heat exchanger.
4. When reinstalling the pressure cap, be sure to tighten it until it seats on the filler neck.
5. With the engine at normal operating temperature, check the coolant level in the coolant recovery canister.

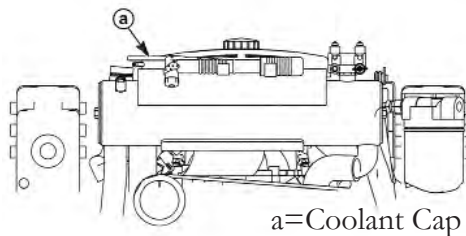



## Cosmetic Care & Maintenance

6. The coolant level should be between the “ADD” and “FULL” marks.

7. Add Extended Life Antifreeze/Coolant (Mercury part # 92-877770K1).

	<b>CAUTION</b>
<b>AVOID ENGINE DAMAGE! DO NOT USE ALCOHOL OR METHANOL BASED ANTIFREEZE OR PLAIN WATER IN THE COOLANT SECTION OF THE <b>CLOSED COOLING SYSTEM</b> AT ANY TIME.</b>	

<b>NOTICE</b>
<b>ADD COOLANT ONLY WHEN THE ENGINE IS AT A NORMAL OPERATING TEMPERATURE.</b>

### *Filling Engine Coolant*

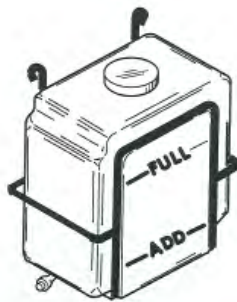

1. Remove the fill cap from the coolant recovery canister.

2. Fill to the “FULL” line with Extended Life Antifreeze/Coolant Mercury part # 92-877770K1.

3. Reinstall the cap onto the coolant recovery canister.

### Changing Engine Coolant

Call your Regal dealer to change coolant in the entire system.



## CHAPTER 7

---

### Propulsion Systems (Stern Drives) ---

#### *General Typical Information For Volvo/MerCruiser Stern Drives*

All stern drives require maintenance just like your engine. Stern drives require daily, weekly, monthly, and yearly inspections to keep the equipment in the best working condition. Also, down time is kept to a minimum so your vessel is ready to go when you need it.

#### **CHECKING THE WATER PICK-UP FEEDS**

Your water pick-up feeds are normally located on your stern drive. They consist of a series of holes that raw water can flow through, where it will be picked up by your cooling system. Ensure that these are not blocked before each trip, or you will risk engine failure. Raise the drives to the trailer position before the outing and look for any possible debris, weeds, or even plastic bag material caught around the intake holes. Refer to the engine manufacturer's operation manual for further information.

#### **CHECKING THE BELLOWS**

The normally black upper rubber insulating part is the stern drive (bellows) The bellows cover the universal joint assembly (like your automobile). These rubber bellows should be kept clear of debris and replaced if ripped since ingested water will cause the joint roller bearings to fail over time. One possible indication that the universal joints have failed due to a leaky bellows or faulty universal seal due to water in the drive housing is by turning the steering wheel sharp while making forward headway in the water. If you hear a chatter type of noise this may indicate the universal joint bearing needs attention. If water enters the stern drive here, have the drive inspected by a marine professional or your Regal dealer.

Note: If the above condition exists, do not continue to run vessel.

On select out drives the lower bellows is part of the exhaust system.



## Cosmetic Care & Maintenance

### Checking Typical Volvo Stern Drive Oil

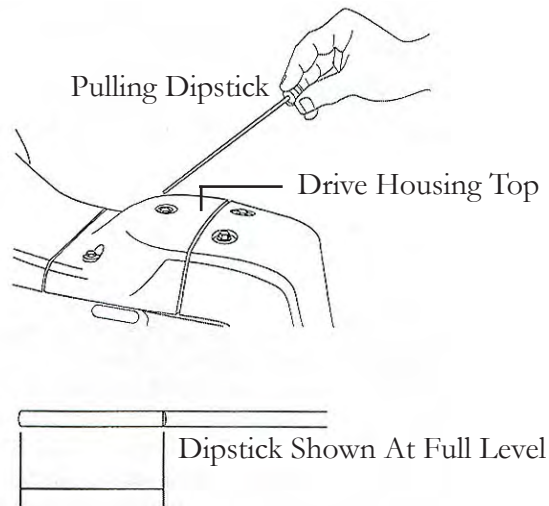

	<b>CAUTION</b>
<p>FULLY THREAD OIL DIPSTICK INTO THE OIL LEVEL HOLE IN THE DRIVE UNIT TO PROPERLY CHECK THE OIL LEVEL. IMPROPER OIL LEVELS MAY RESULT IN SERIOUS STERN DRIVE COMPONENT DAMAGE.</p>	

It is recommended to check the drive oil level before each outing. Fully thread the dipstick into the hole. At this point, remove the dipstick and make sure the oil level is at the top of the mark as shown above. If the oil level is low, add enough oil to bring the level to the top of the mark on the dipstick. **DO NOT OVERFILL.** Tighten up the dipstick with a slotted screwdriver.

If the oil color is milky in appearance there probably is water in the unit normally caused by a leaking seal.

No metal flakes should be present in the oil. If the above conditions exist contact a marine professional or your closest Regal dealer.



## CHAPTER 7

### *Checking Typical MerCruiser Stern Drive Oil*



## CAUTION

ENVIRONMENTAL HAZARD!  
DISCHARGE OF OIL OR OIL WASTE  
INTO THE ENVIRONMENT IS RESTRICTED BY  
LAW. DO NOT SPILL OIL OR OIL WASTE INTO THE  
ENVIRONMENT WHEN USING OR SERVICING  
YOUR VESSEL. DISPOSE OF OIL OR OIL WASTE  
AS DEFINED BY LOCAL & STATE AUTHORITIES.

1. Drive oil level must be checked with the engine cold before starting.
2. Check the gear oil level in the reservoir located on the engine. Keep the gear oil level at the recommended ranges as marked on the reservoir. If any water is visible at the bottom of the reservoir or there are any metal chips in the drive oil do not run the engine since component damage can result. Contact your Regal dealer for more information.

### *Filling the Stern Drive*

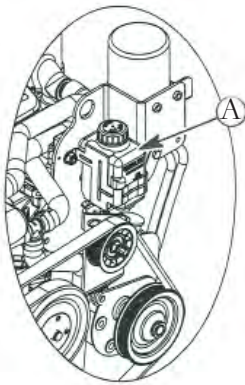

1. If more than 2 ounces of High Performance Gear Lubricant is required to fill the monitor reservoir a seal may be leaking. Contact your Regal dealer.
2. If drive lubricant is free from water and metal chips proceed to fill the reservoir. Remove the gear lube monitor cap. Fill the reservoir with High Performance Gear Lubricant (Merc part # 92-802854A1).

A=Drive Reservoir





## *Cosmetic Care & Maintenance*

---

3. Fill the reservoir so that drive oil level is in the operating range. Do not overfill reservoir. For changing the drive oil refer to the MerCruiser operation manual or contact a Regal dealer for more information.



## CHAPTER 7

### VOLVO MAINTENANCE GUIDE

FUNCTION	ADJUST	CHECK	LUBE	FILL	REPLACE	TIGHTEN
<i>Each Trip</i>						
Anodes		*				
Leaks, Cooling System		*				
Stop Switch		*				
Leaks, Fuel System		*				
Oil, Engine		*		*		
Oil, Drive		*		*		
Safety Equipment		*				
Shift System		*				
Fluid, Power Steering		*		*		
Steering Cable		*				
<i>Monthly</i>						
Battery		*				
Exhaust Sys		*				*
<i>Every 50 Operating Hours</i>						
Battery Connections		*				*
All Belts		*				*
Exhaust System Hoses, Clamps		*				*
Fasteners		*				*
Fuel System		*				



## Cosmetic Care & Maintenance

### VOLVO MAINTENANCE GUIDE CONT.

FUNCTION <i>Per Season</i>	ADJUST	CHECK	LUBE	FILL	REPLACE	TIGHTEN
Bellows & Clamps Drive		*			Every 2 Years	
Exhaust Manifold, Risers		*				
Carb, Fuel Filter					*	
Water Pump Impeller					Every 2 Years	
Leaks, Fuel System		*				
Oil, Engine					Refer To Volvo Engine Operator's Manual	
Oil, Drive						
Oil Filter, Engine						
Propeller & Shaft		*	*			
Remote Control Cable		*				
Spark Plugs					*	
Spark Plugs Wires, Boots		*				
Steering System Cable			*			
Throttle Cable		*	*			
Serpentine where applicable		*				
Carb Adj.	*					
Engine Alignment		*				
Gimbal Bearing			*			
Universal Joints & Splines		*				



## CHAPTER 7

### MERCUISER MAINTENANCE GUIDE

	EACH TRIP	WEEKLY	EVERY 2 MTHS.	EVERY YEAR (100 HRS)	EVERY 3 YRS. (300 HRS)	EVERY 2 YRS.	EVERY 5 YRS.
Oil, Engine	*						
Oil, Drive	*						
Oil, Trim Pump	*						
Fluid, Power Steering	*						
Salt Usage, Flush Cooling	*						
Water Pick-Ups		*					
Anodes		*					
Fuel Pump Site Tube		*					
Battery Connection		*					
Propeller Shaft/Nut			*				
Engine, Corrosion Guard			*				
Touch-Up Paint				*			
Engine Oil & Filter				*			
Drive Oil, Change				*			
Fuel Filter, Replace				*			
Steering & Remote Control				*			



## Cosmetic Care & Maintenance

### MERCUISER MAINTENANCE GUIDE CONT.

	EACH TRIP	WEEKLY	EVERY 2 MTHS.	EVERY YEAR (100 HRS)	EVERY 3 YRS. (300 HRS)	EVERY 2 YRS.	EVERY 5 YRS.
U-Joints, Splines & Bellows				*			
Lube Gimbal Bearing & Engine Coupler				*			
Test MerCathode Bravo's				*			
Engine Mounts, Retorque				*			
Check ignition parts, timing				*			
PCV Valve, Replace				*			
Flame Arrestor, Clean				*			
Belts, Inspect				*			
Leaks & Tightness, Exhaust Sys.				*			
Disassemble Seawater Pump				*			
Leaks & Tightness, Cooling System				*			
Clean seawater section, cooling system				*			
Replace Coolant						*	
Lube U-joints				*			



## CHAPTER 7

---

### Remote Control

---

On selected propulsion packages check the helm control box and the cable attachment at the engine for tightness and shifting without binding. This applies to engines with standard remote controls only. Shift and throttle controls at both the engine and helm areas must be checked on a periodic basis. At the engine end, make sure all control cable hardware is tight and control cable brackets are secure. An application of silicone spray on the cable ends periodically will keep control cables working freely and fights corrosion. At the helm end check to make sure the control box hardware is tightly secured. Contact a marine professional or Regal dealer for further assistance.

Note: Volvo joystick type propulsion and Merc DTS units do not use an actual control cable in the system. Shifting is accomplished through electronic software. See appropriate engine operation manual for further information.



## *Cosmetic Care & Maintenance*

---

### **Seating**

---

Inspect all fasteners and metal for fatigue. Lubricate the slider track of the helm seat with a good quality silicone lube. Check all fasteners periodically for tightness and the effects of corrosion especially in moist environments.

It is a good practice to use a small amount of silicone lube on all hinges to keep them freed up for proper operation.



## CHAPTER 7

---

### Steering

---

Non-electronic steering vessels feature a rack or rotary style steering system featuring a cable that functions with assistance through the engine power steering pump. As you turn the wheel force is applied through the system to a hydraulic cylinder found at the aft end of the engine and attached through the engine power steering pump hoses. With the engine running, check the engine power steering pump level before each outing. Add the appropriate power steering fluid. Periodically inspect the entire steering system for tightness and signs of wear and leaks including the steering wheel. Lubricate the steering shaft at the engine. Refer to the manufacturer's engine manual in the owner's pouch for additional information along with the maintenance chart in this chapter.

CHECK HOSE CONNECTIONS  
FOR LEAKS & TIGHTNESS

CHECK NUT FOR  
TIGHTNESS.







## *Cosmetic Care & Maintenance*

---

### **Stereo**

---

The Fusion® stereo head unit requires little maintenance. When washing the cockpit, do not discharge water directly at the stereo unit. Possible damage may result. As with any CD unit clean your CD's to keep them from skipping. This process also aids in keeping dust out of the unit. Never allow water to enter the iPod mechanism behind the head cover.

For further information, refer to your stereo owner's manual.



## CHAPTER 7

---

### Trim Tabs

---



TYPICAL TRIM TAB PUMP

Periodically check the trim tab anodes for galvanic corrosion. On select units anodes are attached to the actual trim tabs located on the port and starboard transom. A good rule of thumb is to replace a sacrificial zinc anode when it is 30% consumed.

Never paint over the anodes since they will not work properly. Remember they are softer than the aluminum tab they protect and need to be free of barnacles, algae and debris to work the best. In the aft bilge



ANODE

area is located a trim tab pump. Periodically, check for the correct amount of oil in the reservoir. The oil is used to lower and raise the hydraulic cylinders attached to the trim tab plates. Refer to the trim tab operator's manual for oil type and viscosity. Also, check the rams and hoses for leaks. One sign of a

seal leak may be a milky look to the oil or the tabs responding slowly.

A system air leak will normally cause a jerky tab motion.

Refer to the operator's manual for troubleshooting information.



## *Cosmetic Care & Maintenance*

---

### **Windlass-Anchor**

---

Periodic care and maintenance is essential to keep the windlass operating efficiently. Follow the tips below:

- After several anchor retrievals check all mounting hardware to ensure everything is tight. Access to hardware may be gained through the anchor rope locker.
- Wash down the entire anchor locker components after each cruise especially in salt water usage.
- Ensure the anchor is secured by the pin and lanyard hook.
- Annually strip, clean and re-grease all external driveshaft components with SFG synthetic grease containing PTFE or its equivalent. Internal parts and bearings are lubricated and require no further attention.
- For more information refer to the vendor's operation manual found in the owner's information packet or contact your closest Regal dealer.



---

# Troubleshooting

## DIAGNOSTIC CHARTS

The following diagnostic charts will assist you in identifying minor electrical, fuel, and mechanical problems. Select items listed require technical training and tools. Additional assistance may be available in the various component manufacturer's manuals found in the owner's information packet. Contact your closest Regal dealer or marine professional for more information. Most problems can be solved by following a logical sequence of elimination to determine the root cause.

	<b>CAUTION</b>
TO AVOID BODILY INJURY AND PROPERTY DAMAGE! USE ONLY APPROVED MARINE REPLACEMENT PARTS.	

	<b>WARNING</b>
TO AVOID BODILY INJURY AND DEATH! BEFORE PERFORMING ANY MAINTENANCE WORK TURN OFF THE BATTERY SWITCH AND REMOVE THE KEYS FROM THE IGNITION SWITCH.	



## CHAPTER 8

### BATTERY CHARGER

#### Troubleshooting

##### No Blue AC Power LED or Charge Mode Indicator or Battery Type LED

Check for loss of AC power at the 120 VAC outlet. Confirm GFCI (Ground Fault Circuit Interrupter) has not tripped. Check with a meter or 120 VAC test light that AC power is present at the end of your extension cord. Reset AC power if it was not present. Confirm all charger cables are installed with the correct polarity connections at each battery and that all connections are clean and tight. Wait 2 minutes while unit performs self test. If AC power is present and all connections are correct and LEDs do not illuminate, contact ProMariner at 1-800-824-0524 from 8:30 am to 5pm Eastern Time. If your ProSport is within the warranty period of 2 years from the date of purchase, you can go to [www.promariner.com](http://www.promariner.com) where you will find our customer care return form and instructions.

##### Green System Check OK Indicator is OFF & a Red Battery Bank Trouble Status LED is ON.

Identify the battery bank LED that is lit, remove AC power and check the battery bank indicated i.e. 1, 2, 3 (model specific). The LED indicates there is a fault present. Listed below are typical faults and what can be done to clear the red battery bank trouble status indicator (reapply AC power after making any corrections):

**Poor battery connections** - Make sure all connections are tight and clean

**Blown DC cable fuse** - Make sure all fuses are good with a digital ohm meter or continuity tester and visually inspect the ProSport's DC battery cables to insure they have not been compromised or shorted in any way.

**Reverse polarity** - Make sure all wiring connections are color coded and connected properly and that each bank cable goes to one 12V battery where (+) = red (-) = black

**Battery too low to charge** - with a digital voltmeter make sure the battery is over 2.0 volts DC (if not have your battery charged out of the boat and have it load tested by your local battery dealer to insure optimum performance on the water.

**High battery voltage input** - Check to make sure one bank lead was not spread across 2 batteries connected in series for 24 volts DC. If so correct by wiring to the diagrams on pages 11-18.

##### Battery(s) not charging, Blue AC Power LED, RED Charging & Battery Type LEDs are ON

Confirm all charger cables are installed with the correct polarity connections at each battery, and that all connections are clean and tight. Confirm that there are no bank trouble status LED indicators on. With the charger on, read DC voltage at each battery. If any of the readings are less than 1.3 volts DC proceed with the following:

- B. Go to pages 11-18 of this manual and confirm your ProSport Battery Charger is connected correctly as illustrated in the installation drawings.
- C. Upon completing B above; plug your charger into AC power and observe the LED center. Charger should be in the charging mode (charge status indicator should be red). If after completing a full charge cycle, 10-12 hours or more for deeply discharged or completely dead batteries, the charge mode indicator should be green as well as the blue AC power LED.

*Note: If a Digital Volt Meter (DVM) is available to you, instead of waiting to complete a full charge cycle, you can simply use a DVM and take DC voltage measurements across each 12 volt battery. As long as the voltage continues to increase while the red charging LED is on, this will serve as a confirmation that the charger is properly connected and is properly charging.*



## Troubleshooting

DC ELECTRICAL DIAGNOSTIC CHART		
PROBLEM	POSSIBLE CAUSE	POSSIBLE FIX
No 12-volt Power	Battery switch in “off” position	Turn selector switch to “on” position
	Weak or dead battery	Change or replace battery
Battery not charging (Engine running)	Loose belt	Tighten belt
	Faulty alternator	Repair/replace alternator
	Faulty voltmeter	Replace voltmeter
Battery will not hold charge	Faulty/old battery	Replace battery
12-volt equipment not working	Equipment switch “off”	Switch to “on” position
	Circuit breaker blown	Push reset on circuit breaker
	Weak or dead battery	Change or replace battery
	Corroded connection	Eliminate corrosion
	Loose wire	Tighten connection
Internal equipment short	Replace equipment	



## CHAPTER 8

---

STEREO DIAGNOSTIC CHART		
PROBLEM	POSSIBLE CAUSE	POSSIBLE FIX
Error message when I dock my iPhone to my Fusion iPod inside product	Fully-functional and compatible with Apple's iPhone product line, despite this message	Please choose "NO", or simply wait for this message to "time out"
Stereo turns on then off when I first enable the 12 volt power source	When you disable or disconnect the 12 volt power from the unit, it will resume in that state when the 12 volt power supply is resumed	Stereo will go through a boot up phase at first, then it will either go into standby mode or become active (dependent on the state when power was removed)



## Troubleshooting

---

INSTRUMENT DIAGNOSTIC CHART		
PROBLEM	POSSIBLE CAUSE	POSSIBLE FIX
No reading on gauge or gauge reads wrong	Faulty gauge	Replace gauge
	Wiring to gauge faulty	Inspect/repair wiring
	Faulty sender	Replace sender
Gauge reads erratic	Loose ground or hot wire	Repair or replace wire and/or connection





## CHAPTER 8

---

FRESH WATER SYSTEM DIAGNOSTIC CHART		
PROBLEM	POSSIBLE CAUSE	POSSIBLE FIX
No water flow at sink faucet (Head)	Empty water tank	Replace gauge
	Faulty fresh water pump	Inspect/repair wiring
	“Open” circuit breaker	Reset breaker. Activate water pump
	Kinked feed hose	Repair hose
Sink water faucet spits and splatters when activated	Air in system	Repair feed hose or loose hose clamp
Sink drains slowly	Drain is clogged at P trap (if installed)	Remove clog by cleaning P trap
Water from sink smells or tastes bad	Fresh water tank contaminated.	Disinfect fresh water tank (See Technical section) and flush entire system



## Troubleshooting

---

FUEL SYSTEM DIAGNOSTIC CHART		
PROBLEM	POSSIBLE CAUSE	POSSIBLE FIX
Engine won't start or not running right	Fuel tank vent obstructed	Clean vent hose and/or fitting. Check for kinks
	Fuel line Blocked	Check for kinked hose
	Lack of fuel	Clean filter. Check for clogged anti-siphon valve
	Water in fuel	Eliminate water
	Clogged fuel filter	Replace filter elements
	No fuel reaching engine	Check fuel pump output. Clean filters/Check fuel tank gauge level



## CHAPTER 8

---

<b>BOW THRUSTER DIAGNOSTIC CHART</b>		
<b>PROBLEM</b>	<b>POSSIBLE CAUSE</b>	<b>POSSIBLE FIX</b>
Poor thrust or thrust in one direction only	Batteries not charged/ not large enough  Material obstructing tunnel/propeller	Replace/charge batteries  switch off power & remove material
Motor turns but no drive	Propeller blades broken	Replace propeller



## Troubleshooting

---

PERFORMANCE DIAGNOSTIC CHART		
PROBLEM	POSSIBLE CAUSE	POSSIBLE FIX
Excessive vibration	Material obstructing propeller	Remove material by reversing engine
	Bent propeller shaft	Call Regal dealer
	Bent propeller blade	Repair/replace propeller
	Propeller hub slipping	Replace propeller
Poor performance	Engine trim incorrect	Adjust trim
	Uneven load distribution	Adjust boat load
	Engine problem	Call Regal dealer
Loss of steering	Steering system is low on hydraulic fluid	Add fluid as needed to steering system
	Hydraulic fluid leak	Call Regal dealer



## CHAPTER 8

---

REMOTE CONTROL DIAGNOSTIC CHART		
PROBLEM	POSSIBLE CAUSE	POSSIBLE FIX
Remote control stiff/inoperative	Corroded cable	Clean/lubricate cable
	Kinked cable	Replace cable
	Broken cable	Replace cable
	Remote control box jammed	Repair/replace box
Throttle only control inoperative (neutral)	Worn throttle cable	Replace cable
	Binding cable	Follow cable routing
	Broken cable	Replace cable
	Control box worn or in need of lubrication	Refer to information supplied by control manufacturer

**Does not apply to EVC/DTS systems.**



# Troubleshooting

## WINDLASS

Failure to Operate Troubleshoot Chart: Reversing Toggle Control Switch (Part No. 0052519)	
Is there voltage at the input terminal (positive) to the control switch?	If no voltage is present, the battery isolation switch is OFF, the breaker is tripped or a fuse has blown. The battery may also have been dead or disconnected.
YES ↓ NO →	
Check voltage at the output terminals of the control switch with the switch on forward then reverse. Is there voltage at either output terminal for forward then reverse?!	Control switch is defective.
YES ↓ NO →	
Replace motor.	
Sluggish Operation Troubleshoot Chart	
Is windlass overloaded?	Ease the load and ensure the battery is well charged.
YES ↓ NO →	
Check the voltage across the motor leads with the windlass on. (Proper voltage is 13.5 V. Constant low voltage will destroy the motor). Is the voltage low? (Below 11.0 V on a 12 V system).	There is a severe voltage drop in the circuit. Check for undersized cables, poor connections or corroded connections. Also check for resistance across the battery isolation switch or solenoid. (Feel them to see if they are heating up).
YES ↓ NO →	
Is the voltage correct? (Above 11.0 V and anchor is not fouled).	The motor is defective. Replace the motor.
YES →	



## Storage & Winterization



Storage procedures are outlined in this chapter. These are **general guidelines** to follow before longer periods of storage such as over the winter in colder climates. Be sure to familiarize yourself with all relevant information in the owner's pouch. Special winterization procedures are necessary for the boat propulsion equipment and systems. Use the enclosed checklists to help you identify areas of concern and maintenance. These lists cover land stored boats either inside or outside. Call a Regal dealer for further information.



### WARNING

EXPLOSION, FIRE AND POLLUTION HAZARD!  
DO NOT FILL FUEL TANK TO RATED CAPACITY.  
LEAVE ROOM FOR EXPANSION.



### CAUTION

TO PREVENT ENGINE DAMAGE!  
USE ONLY ETHYLENE GLYCOL BASE ANTIFREEZE.  
DO NOT USE ALCOHOL BASE PRODUCTS.



### CAUTION

REMOVE BATTERY(IES) WHEN VESSEL  
IS IN EXTENDED PERIODS OF STORAGE.



## CHAPTER 9

---

### DECOMMISSIONING CHECKLIST

#### ENGINE

- Run engine. Pour a fuel stabilizer/conditioner in the fuel tank. Allow time for product to circulate through the fuel system.
- Change all engine fluids as referenced in the engine manufacturer's owners manual. Contact your Regal dealer.
- Drain cooling and exhaust system or have a marine professional "pickle" the engine. Contact your closest authorized Regal dealer.
- Spray all exterior parts with a rust preventative.

#### STERN DRIVE

- Remove drive. Perform maintenance as referenced in the manufacturer's owners manual or contact your Regal dealer.
- Remove propeller. Refurbish as needed.
- After cleaning use touch up paint on stern drive as needed.
- Apply coat of wax to stern drive.

#### BOAT

- Check hull bottom for any fiberglass damage.
- After cleaning apply a coat of wax to hull and deck surfaces.
- Pour a pint of 50/50 RV type antifreeze into bilge pump.
- Never block up boat bottom. It may cause structural damage.*





## *Storage & Winterization*

---

- Remove batteries. Use a trickle charger as needed.
- Remove all loose gear and electronics from boat. Inspect all equipment for wear and damage. Store in a clean, dry environment.
- Remove drain plug. Clean drain plug hole of debris as needed. Enclose drain plug in plastic bag and tie to steering wheel.
- Make sure bow is higher than stern to permit proper drainage.
- Clean all upholstery and store so it breathes.
- Conduct a visual inspection to ensure boat is balanced properly on a trailer or cradle.
- Cover boat with appropriate cover. Tie down for protection from rain, snow and/or wind. Prop up cover to provide proper ventilation. Do not cover up the fuel vent.
- Drain the fresh water system per instructions in this chapter.



## CHAPTER 9

---

### FRESH WATER SYSTEM

1. Activate the fresh water pump switch.
2. Open all faucets including transom shower (if equipped) and allow tank to empty.
3. Drain the water tank. Shut off fresh water pump switch.
4. Mix nontoxic antifreeze with water in accordance with the manufacturer's recommendations. (Available at marina & RV stores)
5. Pour solution (normally a red color) into the fresh water tank.
6. Turn on fresh water pump switch.
7. Open water faucet and purge until a steady stream of nontoxic antifreeze flows from the faucet. If equipped, do the same to the transom shower. Turn the fresh water switch to the "off" position.

### WASTE SYSTEM

1. With **chemical** heads, make sure to dump both upper and lower tanks. Rinse well with fresh water.
2. With **vacuum type** head, pump out holding tank. Add nontoxic antifreeze to toilet and holding tank. Pump from toilet to holding tank to eliminate any water remaining in supply lines.

## NOTICE

AVOID VESSEL AND ENGINE DAMAGE!  
CONTACT MARINE PROFESSIONAL FOR  
WINTERIZATION INSTRUCTIONS. DAMAGE IS  
NOT COVERED BY REGAL WARRANTY.



## *Storage & Winterization*

---

### RECOMMISSIONING CHECKLIST

#### ENGINE/STERN DRIVE

- Check all components per engine manufacturer's owners manual especially fluid levels.
- Run engine on "ear muffs" (flushette) before launching. Check for fuel, exhaust, oil, and water leaks.

#### BOAT

- Install hull drain plug.
- Install batteries and tighten all terminals.
- Check all equipment, switches, alarms, gauges and breakers for proper operation.
- Add necessary chemicals and water to **chemical** head.
- Add water to fresh water tank. Turn on faucet to purge tank. Refill water tank.
- Make sure all safety gear is on board and in excellent working condition.
- After launching, check controls and gauges for proper operation.



## CHAPTER 9

---

*Notes*



# *Glossary & Index*

Below is a brief list of nautical terminology. For more detailed glossaries we recommend you check your local library, book retailer, marine store or internet.

## **GLOSSARY**

**Abeam:** at right angles to the fore and aft line and off the boat

**Aboard:** on or in the boat

**Above:** the part of the boat on a vessel which is above the interior of the boat

**Aft, After::** aft is the boat section toward the stern or back of the boat

**Amidships:** toward the center of the boat from either side to side or rear to front

**Beam:** the width of a boat at its widest part

**Bilge:** the lower interior of the hull of the boat

**Bitter end:** the end of a line also the end of an anchor line

**Bow:** the front, or forward part of the boat

**Bulkhead:** the vertical partition or wall of a boat



## CHAPTER 10

---

**Cast off:** to let go or release

**Chine:** the line fore and aft formed by the intersection of the side and bottom of the boat

**Chock:** deck fitting used to secure or guide anchor or tie lines

**Cleat:** deck fitting with protruding arms around which lines are secured

**Cockpit:** the seating space used to accommodate passengers

**Cuddy:** a small cabin in the fore part of the boat

**Deck:** the open flooring surface on which crew and passengers walk

**Draft** the depth from the waterline of the boat to the lowest part of the boat, which indicates how much water is required to float the boat

**Fathom:** a measurement of depth; one fathom equals six feet

**Fender:** a cushion hung from the side of a boat to prevent it from rubbing against a dock or against other boats

**Fend off:** to push off to avoid sharp contact with dock or other vessel

**Fore:** the part of the boat toward the bow or front

**Freeboard:** the height of the top side from the waterline to the deck at its shortest point. (The distance from the sheer or gunwale to the water)

**Galley:** cooking area

**Gunwale:** rail or upper edge of the side of the boat

## *Glossary & Index*

---

**Head:** toilet

**Hull:** the part of the hull from the deck down

**Keel:** the lowest point of a boat; the backbone of the vessel

**Knots:** a measurement of speed indicating nautical miles per hour

**Lee:** the side opposite that from which the wind is blowing; the side sheltered from the wind

**Leeward:** the direction toward which the wind is blowing

**PFD:** personal flotation device; required for each person aboard

**Port:** the left side of the boat when facing forward (an easy way to remember the difference between “port” and “starboard” is that both “port” and “left” have four letters)

**Shank:** the main body of an anchor

**Sheer:** the curve of the boat’s deck from fore to aft when seen from the side

**Starboard:** the right side of the boat when facing forward

**Stern:** the aft end of the boat

**Stern drive:** an inboard/outboard (I/O) unit

**Stringer:** strengthening integral unit fastened from fore to aft inside the hull and fiberglass encapsulated for added strength: much like the skeleton system of our body

**Top off:** to fill up a tank

**Transom:** the vertical part of the stern



## CHAPTER 10

---

**Trim:** the boat's balance when properly loaded

**Wake:** the path of a boat left astern in the water

**Windward:** the direction from which the wind blows; opposite of leeward



# Glossary & Index

---

## INDEX

### A

Accidents 1-27  
Accident Reporting 1-28  
Air Compressor/Inflator 6-2  
Anchor Light 1-16  
Anchoring 5-25  
Anchor Windlass 6-3  
  
Audible Alarms 3-13  
Automatic Fire Extinguisher 3-11

### B

Battery 4-1  
6-13  
7-13  
  
Battery Charger 6-14  
7-14  
  
Battery Management Panel 6-20  
Battery Switch 4-9  
6-10  
  
Bilge Pump 4-6  
4-7  
6-24  
7-16  
  
Blower 4-7  
5-5  
6-25  
7-17  
  
Board Racks 6-26  
Boating Under The Influence 1-25  
Bow Filler Cushion 6-27  
Bow Scuff Plate 6-28  
Bow Thruster 6-29  
Bow Walk-Through-Doors 6-30  
Breakers & Fuses 4-12  
Breaker Panels 6-31  
Breast Lines 5-11  
Bridge Clearance 2-10

### C

Canvas 6-36  
7-7  
  
Carbon Monoxide 1-21  
Yacht Certification Plate Int-14  
  
Cardiopulmonary Resuscitation 5-30  
Cockpit Carpet 6-56  
Cockpit Heater 6-58  
Cockpit Refrigerator 6-59  
Cockpit Seagrass Mat 6-60  
Cockpit Table 6-61  
Cosmetics 7-1  
Controls 3-7

### D

Decommissioning 9-2  
Depth Sounder 3-10  
6-61  
  
Diagnostic Charts 8-1  
Direct Current (DC) 4-1  
Distress Signals 1-12  
Diver's Flag 1-29  
Docking 5-15  
Docking Lights 6-64  
Dock Lines 5-11  
Drain Plug 6-66  
Drawings 11-5

### E

EPIRB 1-20  
Electrical 4-1  
Emergencies 5-29  
Engine 3-1  
7-28  
  
Engine Hatch 6-67  
Engine Status Monitoring Panel 3-12  
Environmental Awareness 5-32  
Exhaust 1-21



## CHAPTER 10

---

### F

Fenders	5-10
Fiberglass Maintenance	7-4
Fire Extinguishers	1-10

7-12

First Aid	5-30
Float Plan	Int-9
Fresh Water System	4-18

Fuel	6-68
	4-13
	5-3
	7-18

### G

Galvanic/Stray Current Corrosion	7-19
Garbage Placard	1-18
Gas Vapor Detector	6-70
Gathering Headway	5-17
Gauges (Instrumentation)	3-8
Gelcoat Maintenance	7-4
General Boating Safety	1-3
Getting Underway	5-1
Glossary	10-1
Gray Water	6-73
Grill	6-74

### H

HIN	Int-8
Horn	1-19
	4-8
Hour Meter	3-8
Hull Bottom	7-10
Hypothermia	5-31

### I

Ignition Switch	3-6
Index	10-5
Interior Fabrics	7-4
International Distress Signals	1-14

### K

Knots	5-28
-------	------

### L

Labels	1-1
Ladder	6-79
Law of Salvage	5-27
Lighting-All Around/Stern	1-16
	6-81
Loading	Int-14
Launch & Cruise Checklist	Int-12

### M

Maneuvering	5-17
Maintenance Guides	7-42
Maintaining PFD'S	1-9
Marine Sanitation Devices	1-17
Masthead Light	1-16
	1-19
Mayday	1-15
MerCruiser	7-34
	7-46
Metal (Cleaning)	7-10
Minimum Required Equipment	1-19
Mooring	5-12

## *Glossary & Index*

---

### **N**

Navigation Aids	2-6
Navigation Lights	1-15
	1-19
Navigation Rules	2-1
Neutral Safety Switch	3-14
New Boat Delivery Checklist	Int-17
Night Running	2-9

### **O**

Oil Pressure Gauge	3-9
Oil Spills	1-17
Overloading	Int-14
Owner's Information Packet	Int-8
Owner's Registration	Int-15
Owner Responsibilities	Int-15

### **P**

Personal Flotation Devices	1-7
	1-19
Plastics	7-3
Pollution Regulations	1-17
Power Platform	6-82
Power Tower	6-83
Power Trim	5-20
Precautionary Safety Labels	1-2
Pre-departure questionnaire	5-1
Propellers	3-4
	7-24
Propulsion	3-4
	7-40

### **R**

Recommissioning	9-5
Registration Information	Int-19
Rear View Mirror	6-88
Refreshment Center-Head	6-89
RegalVue Display	6-90
Remote Control	3-15
	5-7
	7-48
	8-2
Right-Of-Way	2-2
Rules Of The Road	2-1

### **S**

Safety	1-1
	Int-14
Seating	6-79
	6-94
Shallow Water Operation	Tech
	5-23
Sirius Satellite Radio	6-95
Ski Pylon	6-96
Sound Producing Devices	1-15
Specifications	Tech
	3-8
Speedometer	5-11
Spring Line	5-6
Starting & Stopping	5-11
Stern Line	5-8
Steering	7-50
	7-50
Stereo	6-97
	7-51



## CHAPTER 10

---

Stern Drive	3-2	<b>V</b>	
	5-15	Ventilation	3-2
	7-40		5-7
	9-2	Visibility	Int-14
	9-5		5-23
Sunbrella Cleaning	7-8	Visual Distress Signals	1-12
Swim Platform	6-111	Volt Meter	3-9
Switches (DC)	4-5	Volvo	7-29
			7-44
<b>T</b>			
Tachometer	3-8	<b>W</b>	
Technical	11-1	Wake	1-33
Temperature Gauge	3-9	Warning Labels	1-1
Toilet	4-20	Wash down	6-88
	6-113	Warranty	Int-18
Towing	5-26	Water Heater	6-125
Trim Angle	5-20	Water Skiing	1-29
Trim Gauge	3-10	Weather	1-34
Trim Tabs	6-120	Windshield	6-126
	7-52	Windshield Wiper	6-126
Troubleshooting	8-1	Winterizing	9-1
Turning	5-18	Wiring Color Codes	4-2
<b>U</b>			
Underwater Lights	6-124		
Upholstery	7-1		



### NOTICE



The following technical information and drawings are accurate up to the printing date listed at the beginning of this manual. These drawings can be an aid in diagnosing electrical/mechanical problems along

with the charts located in the troubleshooting chapter.

**Note that all product specifications, models, standard and optional equipment, systems, along with the technical information is subject to change without notice.**

For more information contact your nearest authorized Regal dealer. For the location of your nearest authorized dealer call 407-851-4360. or visit the web-site at [www.regalboats.com](http://www.regalboats.com).

Your Regal dealer has received special factory training on the entire product line and his services should be employed to solve technical problems.



## DISINFECTION OF POTABLE WATER SYSTEM

The following information is taken from the Handbook on Sanitation of Vessel Water Points and is available from the Public Health Service publication #274.

It is a good idea to disinfect the potable water system when entering long periods of storage or at the beginning of your boating season.

Following is a suggested method in proper order to accomplish system disinfection:

1. Flush entire system completely by permitting potable water to flow through it.
2. Drain system completely.
3. Fill entire system with a chlorine solution having a strength of 100 parts per million, and allow to sit for one hour. Shorter time frames will require more concentrations of chlorine solution. See the chart.

4. Drain chlorine solution from entire system.

5. Flush whole system thoroughly with fresh potable water.

6. Fill system with fresh potable water.

The chart below indicates how much disinfecting agent is needed to make up various quantities of 100 parts per million chlorine solution.

CHLORINE COMPOUND AMOUNTS REQUIRED FOR 100 PPM SOLUTION			
SOLUTION (GALLONS)	CHLORINATED LIME 25% (OUNCES)	HIGH TEST CALCIUM HYPOCHLORITE 70%	LIQUID SODIUM HYPOCHLORITE 1% (QUARTS)
5	0.3	0.1	0.2
10	0.6	0.2	0.4
15	0.9	0.3	0.6
20	1.2	0.4	0.8
30	1.8	0.6	1.2
50	3.0	1.0	2.0
100	6.0	2.0	4.0

NOTE: Information from this chart taken from Handbook on Sanitation of Vessel Water Points- US Public Health Service Publication No.274 reprinted June 1963



## Technical Information

2800 SPECIFICATIONS		
LENGTH OVERALL W/ PLATFORM	USA 28' 8"	CE 8.7 M
BEAM	9'	2.74 M
DEADRISE	21 DEGREES	
APPROXIMATE DRY WEIGHT W/ VOLVO 380 CATALYST W/DP STERN DRIVE	6,700 LBS.	3,039 KG
APPROXIMATE BRIDGE CLEARANCE TO TOP OF POWER TOWER LIGHT.	8'	2.44 M
APPROXIMATE BRIDGE CLEARANCE W/ TOWER IN LOW- ERED FORWARD POSITION	5' 6"	1.67 M
COCKPIT DEPTH	36"	.91 M
APPROXIMATE DRAFT- DRIVE UP/ DOWN	27"-38"	.68-.96 M
FUEL CAPACITY *	104 GALS	393 L
WATER CAPACITY *	18 GALS	68.1 L
WASTE CAPACITY *	2.6 Est. Gallons w/ Chemical Toilet	9.84 Est. Liters w/ Chemical Toilet
PERSONS CAPACITY	YACHT CERTIFIED	13
MAXIMUM CAPACITY; PERSONS & GEAR	YACHT CERTIFIED	N/A
MAXIMUM LOAD RECOMMENDED; PERSONS & GEAR	YACHT CERTIFIED	1254 KG

\* =APPROXIMATE  
TBD=TO BE DETERMINED



## TYPICAL LABEL & PLACARD LOCATION

Arrows Show Approximate Location

**DISCHARGE OF OIL PROHIBITED**  
 THE FEDERAL WATER POLLUTION CONTROL ACT PROHIBITS THE DISCHARGE OF OIL OR OILY WASTE INTO OR UPON THE NAVIGABLE WATERS OF THE UNITED STATES OR THE WATERS OF THE CONTIGUOUS ZONE OR WHICH MAY AFFECT NATURAL RESOURCES BELONGING TO OR PERTAINING TO OR UNDER THE EXCLUSIVE MANAGEMENT AUTHORITY OF THE UNITED STATES. IF SUCH DISCHARGE CAUSES A FILM OR DISCOLORATION OF THE SURFACE OF THE WATER OR CAUSES A SLUDGE OR EMULSION BENEATH THE SURFACE OF THE WATER, VIOLATORS ARE SUBJECT TO SUBSTANTIAL CIVIL PENALTIES AND/OR CRIMINAL SANCTIONS INCLUDING FINES AND IMPRISONMENT.

The Manufacturer is Required to Provide the following information to the owner of a motorboat. This information is provided in this document. It is the owner's responsibility to read and understand this information before using the motorboat.		
1. The name of the manufacturer of the motorboat.	2. The name of the manufacturer of the outboard motor.	3. The name of the manufacturer of the inboard motor.
4. The name of the manufacturer of the outboard motor.	5. The name of the manufacturer of the inboard motor.	6. The name of the manufacturer of the outboard motor.
7. The name of the manufacturer of the inboard motor.	8. The name of the manufacturer of the outboard motor.	9. The name of the manufacturer of the inboard motor.
10. The name of the manufacturer of the outboard motor.	11. The name of the manufacturer of the inboard motor.	12. The name of the manufacturer of the outboard motor.

**CAUTION:** TO AVOID INJURY, WINDOW MUST BE SECURED IN THE CLOSED POSITION WHEN VESSEL IS IN MOTION. USE BOTH WINDOW LOCKS.  
TAYLOR MADE SYSTEMS, INC.

**WARNING**  
 GASOLINE VAPORS CAN EXPLODE BEFORE STARTING ENGINE. OPERATE BLOWER 4 MIN. AND CHECK ENGINE COMPARTMENT FOR GASOLINE LEAKS OR VAPORS. RUN BLOWER BELOW CRUISING SPEED.

**WARNING**  
 Carbon monoxide (CO) can cause brain damage or death. Carbon monoxide can be present in the cabin. Signs of carbon monoxide poisoning include headache, dizziness, confusion, and loss of consciousness. Get fresh air if anyone shows signs of carbon monoxide poisoning. Get fresh air if anyone experiences dizziness or other symptoms. Carbon monoxide detector must be functioning at all times.

Cabin Models Only

**YACHT CERTIFICATION**  
 MEETS U.S. EPA EVAP STANDARDS USING CERTIFIED COMPONENTS  
REGAL MARINE INC., ORLANDO, FL

**LIFETIME Plus WARRANTY**  
REGAL BOATS

**WARNING**  
 ROTATING PROPELLER MAY CAUSE SERIOUS INJURY OR DEATH. SHUT OFF ENGINE WHEN NEAR PERSONS IN THE WATER.

**MEETS U.S. EPA EVAP STANDARDS USING CERTIFIED COMPONENTS**  
REGAL MARINE INC., ORLANDO, FL



**CAUTION**  
 WHEN OPERATING WAKESPORT TOWER KEEP ALL BODY PARTS CLEAR OF TOWER HINGE MECHANISMS.

**WARNING!**  
 MAXIMUM CAPACITY OF SWIM PLATFORM  
 500 POUNDS  
 226 KG

**WARNING**  
 AVOID SERIOUS INJURY OR DEATH FROM FIRE OR EXPLOSION RESULTING FROM LEAKING FUEL. INSPECT SYSTEM FOR LEAKS AT LEAST ONCE A YEAR.

**WARNING**  
 Carbon monoxide (CO) can cause brain damage or death. Engines and generator exhaust contains odorless and colorless carbon monoxide gas. Carbon monoxide will be around the back of the boat when engines or generators are running. Move to fresh air, if you feel nausea, headache, dizziness, or drowsiness.

**WARNING**  
 ROTATING PROPELLER(S) MAY CAUSE SERIOUS INJURY OR DEATH! DO NOT APPROACH OR USE LADDER WHEN ENGINE IS RUNNING.





2800

**TYPICAL DOMESTIC FUEL SYSTEM**

EPA COMPLIANT FUEL TANK SHOWN BELOW

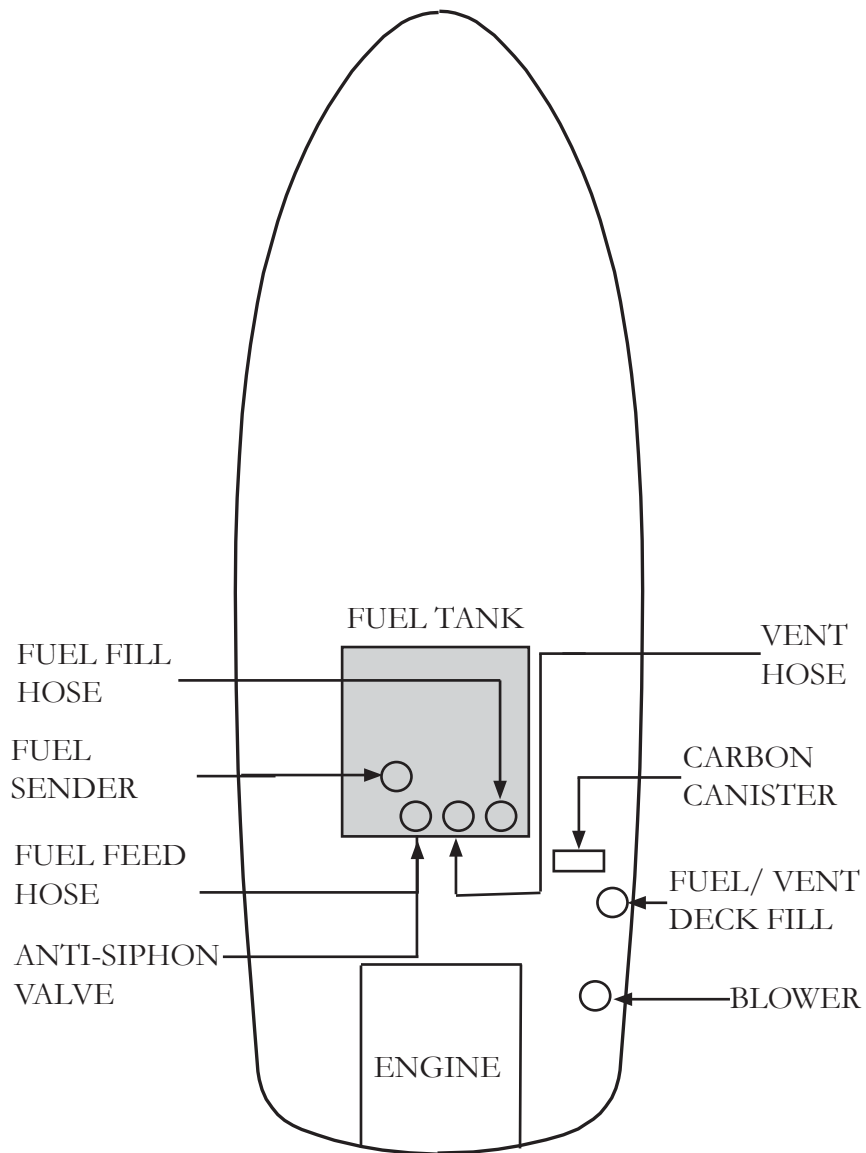





PROPRIETARY AND CONFIDENTIAL:  
 THE INFORMATION CONTAINED IN THIS DRAWING IS THE SOLE PROPERTY OF REGAL MARINE  
 INDUSTRIES. ANY REPRODUCTION IN PART OR AS WHOLE WITHOUT THE WRITTEN  
 PERMISSION OF REGAL MARINE INDUSTRIES IS PROHIBITED.

 <b>REGAL MARINE INDUSTRIES</b> <small>2300 JETPORT DRIVE        ORLANDO, FLORIDA 32809        TEL. 407/851-4360</small>		
<small>ALL RIGHTS RESERVED</small>		
DRAWING TITLE:		
<b>2800 Starboard Profile</b>		
DATE:	REVISION:	PAGE:
6/3/14	-	1 OF 1
DRAWN BY:	APPROVED BY:	DWG. NO.:
JAL	-	4

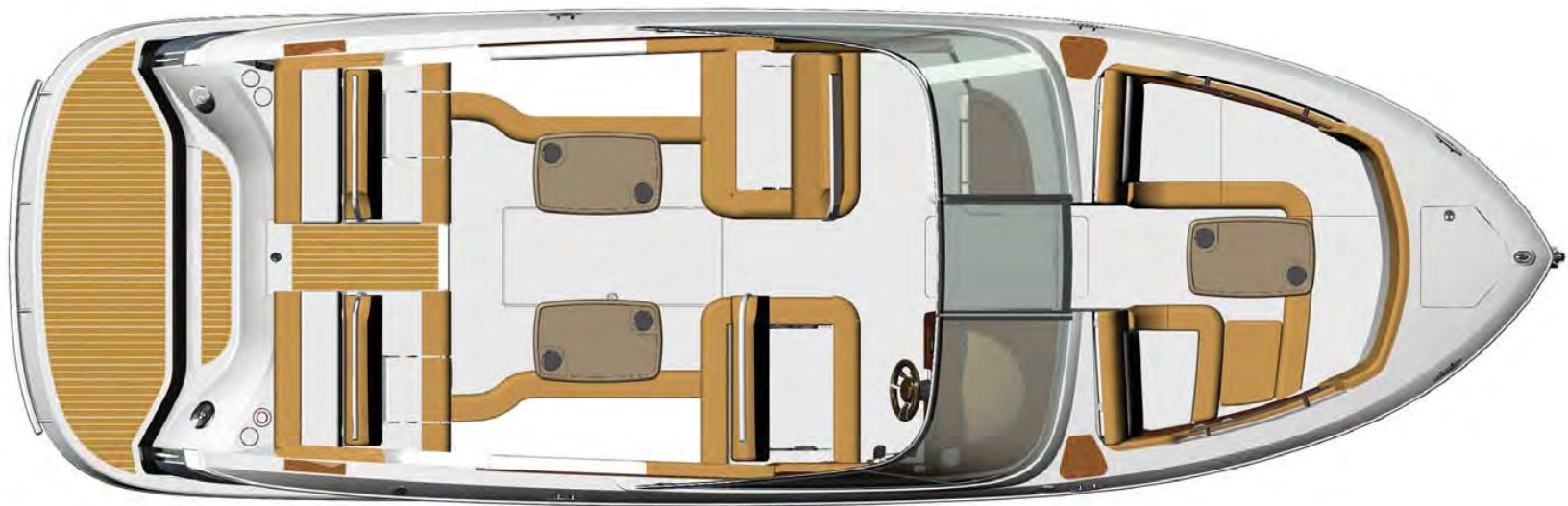
**2800 BOW RIDER STARBOARD PROFILE**



PROPRIETARY AND CONFIDENTIAL:  
 THE INFORMATION CONTAINED IN THIS DRAWING IS THE SOLE PROPERTY OF REGAL MARINE  
 INDUSTRIES. ANY REPRODUCTION IN PART OR AS WHOLE WITHOUT THE WRITTEN  
 PERMISSION OF REGAL MARINE INDUSTRIES IS PROHIBITED.

 <b>REGAL MARINE INDUSTRIES</b> <small>2300 AIRPORT DRIVE        ORLANDO, FLORIDA 32809        TEL: (407) 851-4360</small>			<small>ALL RIGHTS RESERVED</small>
DRAWING TITLE:			
<b>2800 General Arrangement</b>			
DATE:	REVISION:	PAGE:	
6/3/14	-	1 OF 1	
DRAWN BY:	APPROVED BY:	DWG. NO.:	
JAL	-	3	

## 2800 BOW RIDER GENERAL ARRANGEMENT



**KEY**

- A. FUEL TANK
- B. FUEL TANK FILLING POINT
- C. WATER TANK
- D. WATER TANK FILLING POINT
- E. HOLDING TANK
- F. HOLDING EMPTYING POINT
- G. SEACOCKS
- H. THRU-HULL FITTINGS
- I. AUTOMATIC FIRE EXTINGUISHER
- J. ANCHOR STRONG POINT
- K. TOWING STRONG POINT
- L. BATTERY SWITCH
- M. BILGE PUMP

PROPRIETARY AND CONFIDENTIAL:  
 THE INFORMATION CONTAINED IN THIS DRAWING IS THE SOLE PROPERTY OF REGAL MARINE INDUSTRIES. ANY REPRODUCTION IN PART OR AS WHOLE WITHOUT THE WRITTEN PERMISSION OF REGAL MARINE INDUSTRIES IS PROHIBITED.

		<b>REGAL MARINE INDUSTRIES</b>	
2250 JETTIFORT DRIVE ORLANDO, FLORIDA 32809 TEL (407) 851-4350		ALL RIGHTS RESERVED	
DRAWING TITLE: <b>2800 Component Location</b>			
DATE:	6/3/14	REVISION:	-
DRAWN BY:	JAL	APPROVED BY:	-
PAGE:	1 OF 1	DWG. NO.:	7

# 2800 BOW RIDER COMPONENT LOCATION

15.5"W X 29.5"L Allowance Per Person

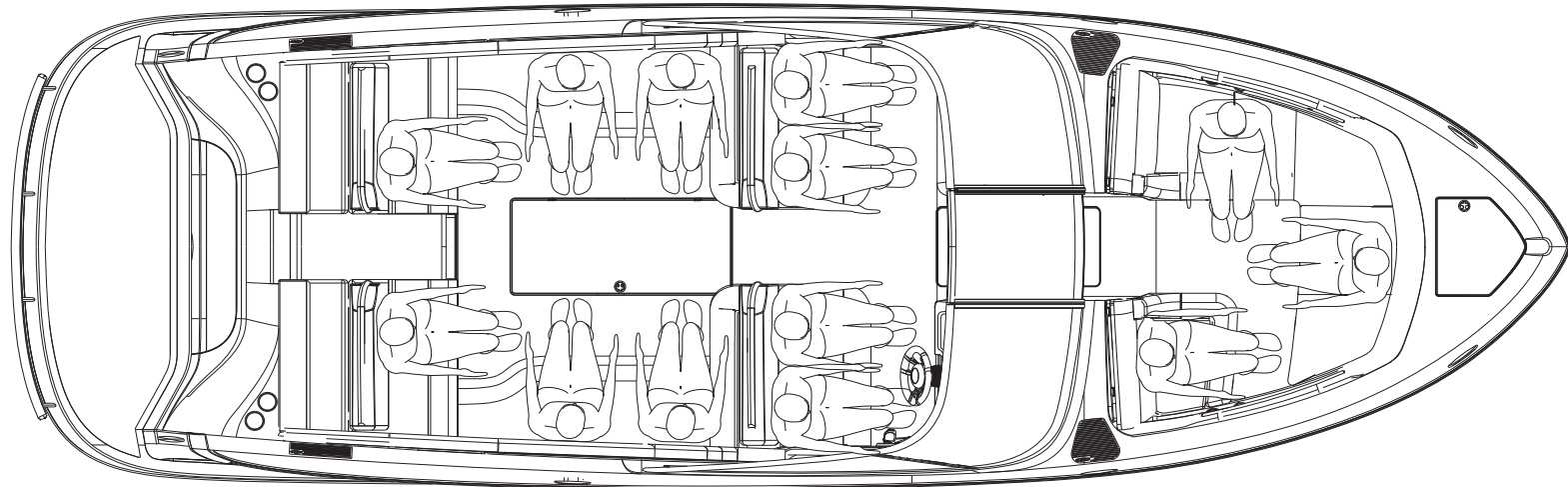
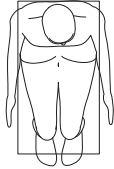



Persons Capacity: 13 Persons

PROPRIETARY AND CONFIDENTIAL:  
THE INFORMATION CONTAINED IN THIS DRAWING IS THE SOLE PROPERTY OF REGAL MARINE INDUSTRIES. ANY REPRODUCTION IN PART OR AS WHOLE WITHOUT THE WRITTEN PERMISSION OF REGAL MARINE INDUSTRIES IS PROHIBITED.

			<b>REGAL MARINE INDUSTRIES</b> 2399 JET PORT DRIVE ORLANDO, FLORIDA 32809 TEL: (407) 851-4360		
			ALL RIGHTS RESERVED		
DRAWING TITLE: <b>2800 Persons Capacity</b>					
DATE:	02/07/14	REVISION:	-	PAGE:	1 OF 1
DRAWN BY:	JAH	APPROVED BY:	-	DWG. NO.:	2

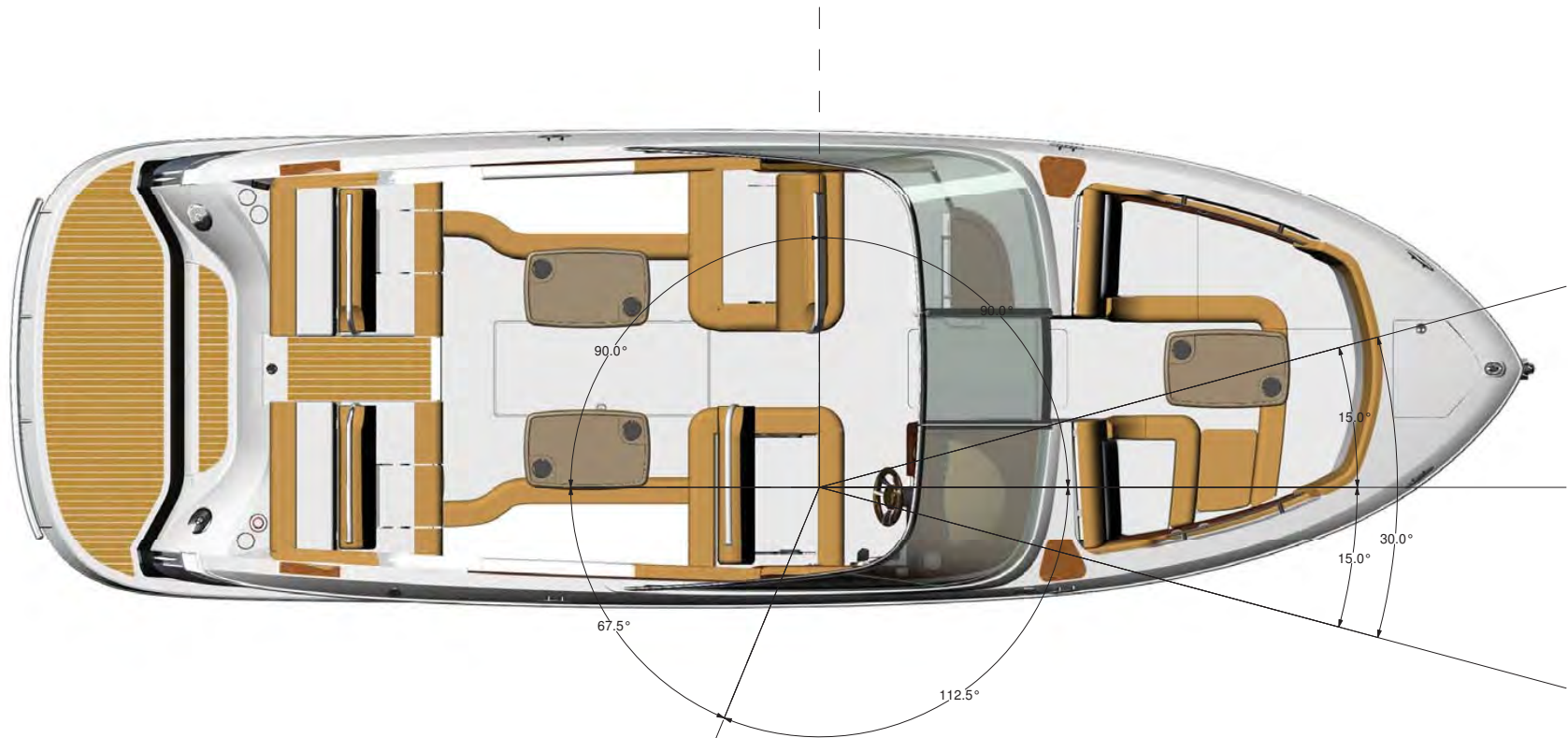
# 2800 BOW RIDER STANDARD SEATING POSITIONS



 <b>REGAL MARINE INDUSTRIES</b> <small>2500 JEFFERSON DRIVE          ORLANDO, FLORIDA 32809          TEL (407) 881-4360</small>		
DRAWING TITLE: <b>2800 Range of Visibility</b>		
DATE: 6/3/14	REVISION: -	PAGE: 1 OF 1
DRAWN BY: JAL	APPROVED BY: -	DWG. NO.: 15

PROPRIETARY AND CONFIDENTIAL:  
 THE INFORMATION CONTAINED IN THIS DRAWING IS THE SOLE PROPERTY OF REGAL MARINE  
 INDUSTRIES. ANY REPRODUCTION IN PART OR AS WHOLE WITHOUT THE WRITTEN  
 PERMISSION OF REGAL MARINE INDUSTRIES IS PROHIBITED.

**2800 BOW RIDER-RANGE OF VISIBILITY**

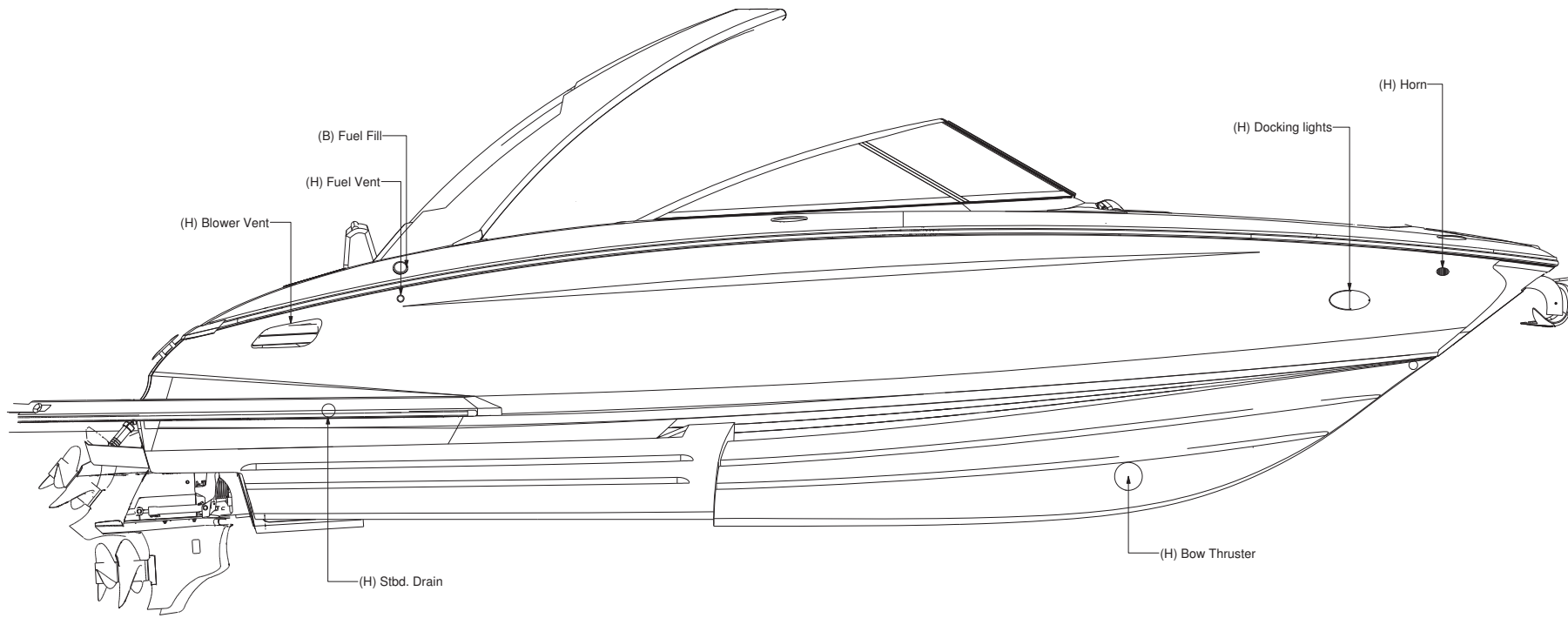

**KEY**

- |                             |                                |
|-----------------------------|--------------------------------|
| A. FUEL TANK                | H. THRU-HULL FITTINGS          |
| B. FUEL TANK FILLING POINT  | I. AUTOMATIC FIRE EXTINGUISHER |
| C. WATER TANK               | J. ANCHOR STRONG POINT         |
| D. WATER TANK FILLING POINT | K. TOWING STRONG POINT         |
| E. HOLDING TANK             | L. BATTERY SWITCH              |
| F. HOLDING EMPTYING POINT   | M. BILGE PUMP                  |
| G. SEACOCKS                 | N. MANUAL FIRE EXTINGUISHER    |

PROPRIETARY AND CONFIDENTIAL:  
 THE INFORMATION CONTAINED IN THIS DRAWING IS THE SOLE PROPERTY OF REGAL MARINE INDUSTRIES. ANY REPRODUCTION IN PART OR AS WHOLE WITHOUT THE WRITTEN PERMISSION OF REGAL MARINE INDUSTRIES IS PROHIBITED.

		<b>REGAL MARINE INDUSTRIES</b> <small>2300 JETPORT DRIVE          ORLANDO, FLORIDA 32809          TEL (407) 851-4360</small>	
<b>2800 Starboard Thru-Hulls</b>			
DATE:	6/3/14	REVISION:	-
DRAWN BY:	JAL	APPROVED BY:	-
PAGE:	1 OF 2	DWG. NO.:	6

# 2800 BOW RIDER STARBOARD THRU-HULLS (1 OF 2)

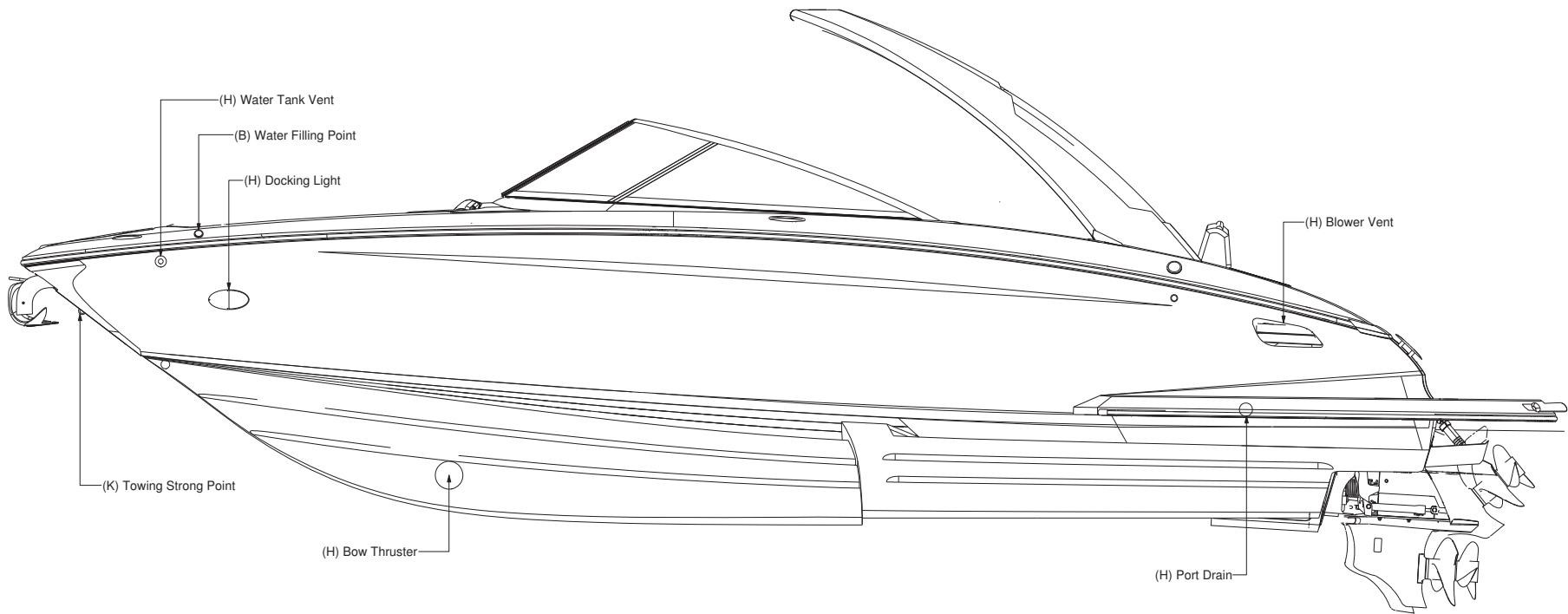

KEY

- |                             |                                |
|-----------------------------|--------------------------------|
| A. FUEL TANK                | H. THRU-HULL FITTINGS          |
| B. FUEL TANK FILLING POINT  | I. AUTOMATIC FIRE EXTINGUISHER |
| C. WATER TANK               | J. ANCHOR STRONG POINT         |
| D. WATER TANK FILLING POINT | K. TOWING STRONG POINT         |
| E. HOLDING TANK             | L. BATTERY SWITCH              |
| F. HOLDING EMPTYING POINT   | M. BILGE PUMP                  |
| G. SEACOCKS                 | N. MANUAL FIRE EXTINGUISHER    |

PROPRIETARY AND CONFIDENTIAL:  
 THE INFORMATION CONTAINED IN THIS DRAWING IS THE SOLE PROPERTY OF REGAL MARINE INDUSTRIES. ANY REPRODUCTION IN PART OR AS WHOLE WITHOUT THE WRITTEN PERMISSION OF REGAL MARINE INDUSTRIES IS PROHIBITED.

 <b>REGAL MARINE INDUSTRIES</b> <small>2300 JETPORT DRIVE        ORLANDO, FLORIDA 32809        TEL (407) 851-4360</small>			ALL RIGHTS RESERVED
DRAWING TITLE: <b>2800 Port Thru-Hulls</b>			
DATE: <b>6/3/14</b>	REVISION: <b>-</b>	PAGE: <b>2 OF 2</b>	
DRAWN BY: <b>JAL</b>	APPROVED BY: <b>-</b>	DWG. NO.: <b>6</b>	

## 2800 BOW RIDER PORT THRU-HULLS (2 OF 2)



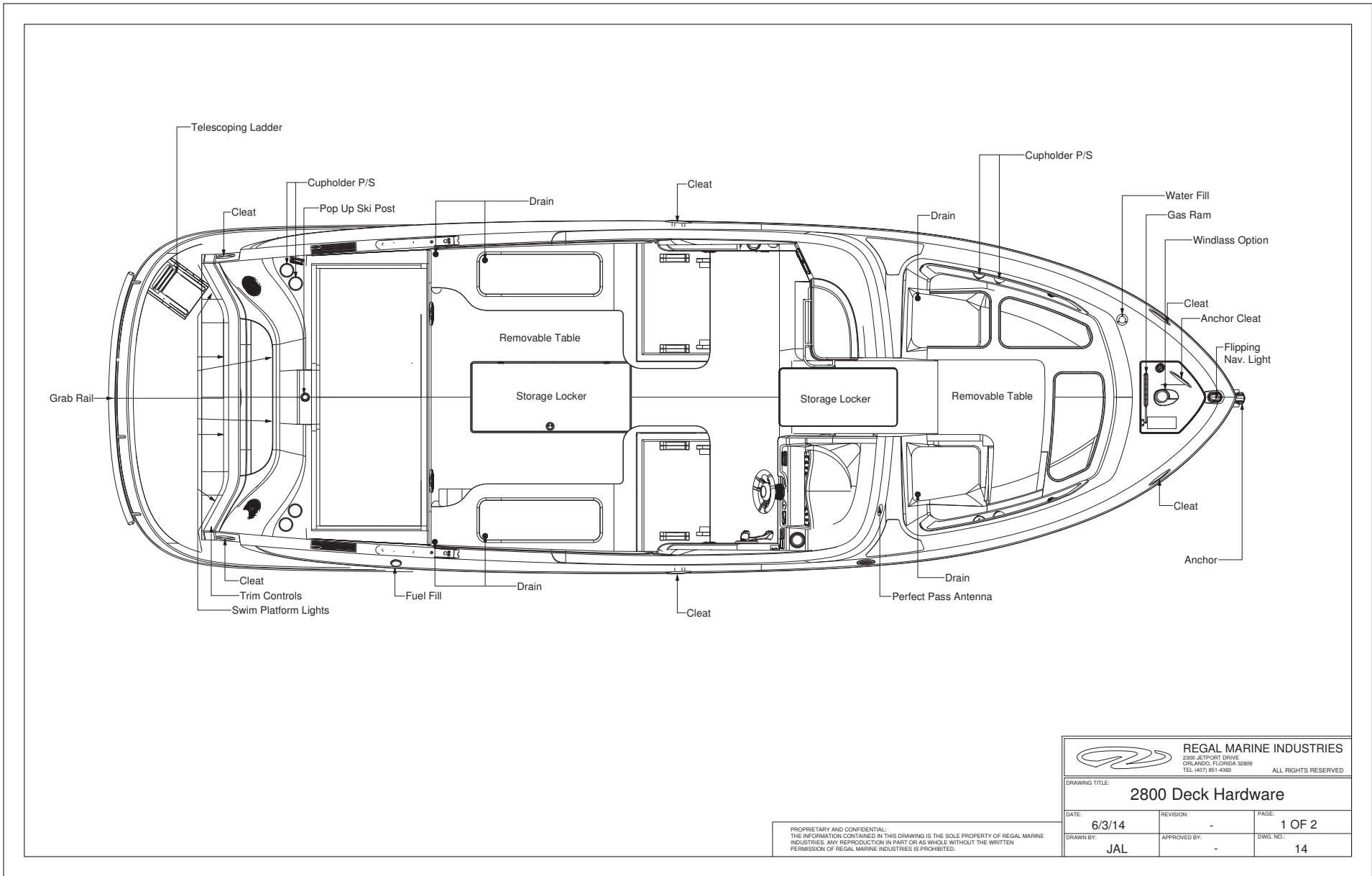

 <b>REGAL MARINE INDUSTRIES</b> 2300 JETPORT DRIVE ORLANDO, FLORIDA 32809 TEL (407) 851-4360			ALL RIGHTS RESERVED
DRAWING TITLE:			
<b>2800 Deck Hardware</b>			
DATE:	REVISION:	PAGE:	
6/3/14	-	1 OF 2	
DRAWN BY:	APPROVED BY:	DWG. NO.:	
JAL	-	14	

PROPRIETARY AND CONFIDENTIAL:  
 THE INFORMATION CONTAINED IN THIS DRAWING IS THE SOLE PROPERTY OF REGAL MARINE INDUSTRIES. ANY REPRODUCTION IN PART OR AS WHOLE WITHOUT THE WRITTEN PERMISSION OF REGAL MARINE INDUSTRIES IS PROHIBITED.

# 2800 BOW RIDER DECK HARDWARE (1 OF 2)

**Starboard Arch Base**

Port Side Opposite Hand

Arch Hinge  
Plate

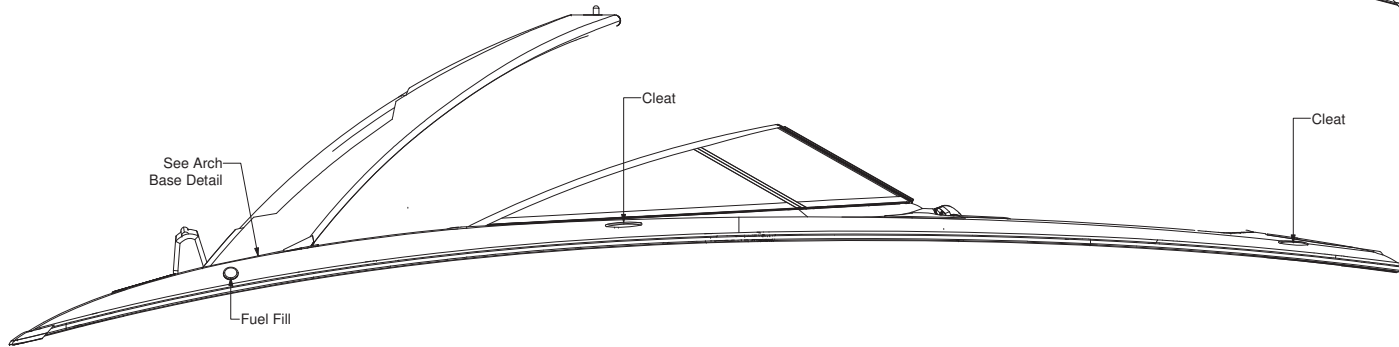
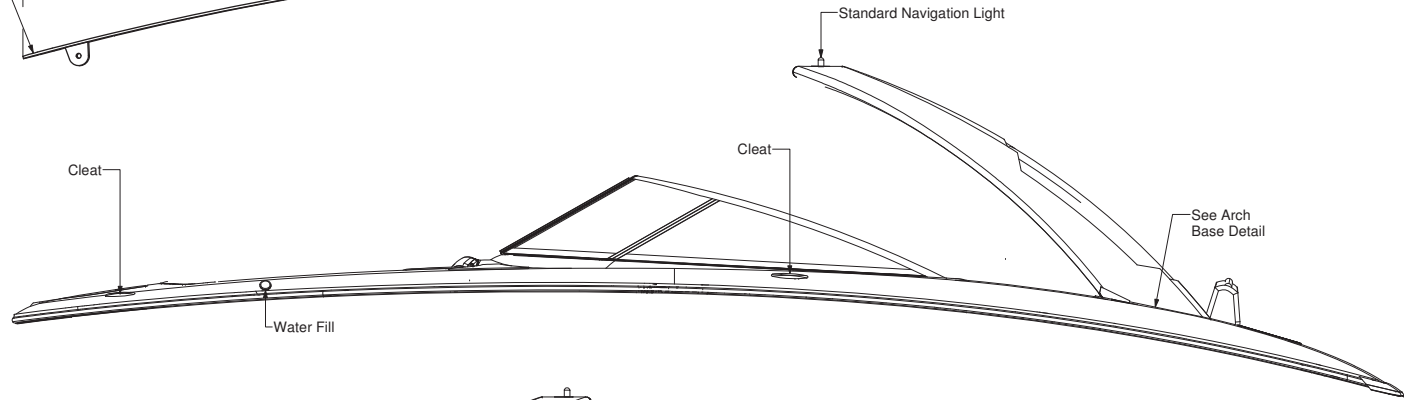

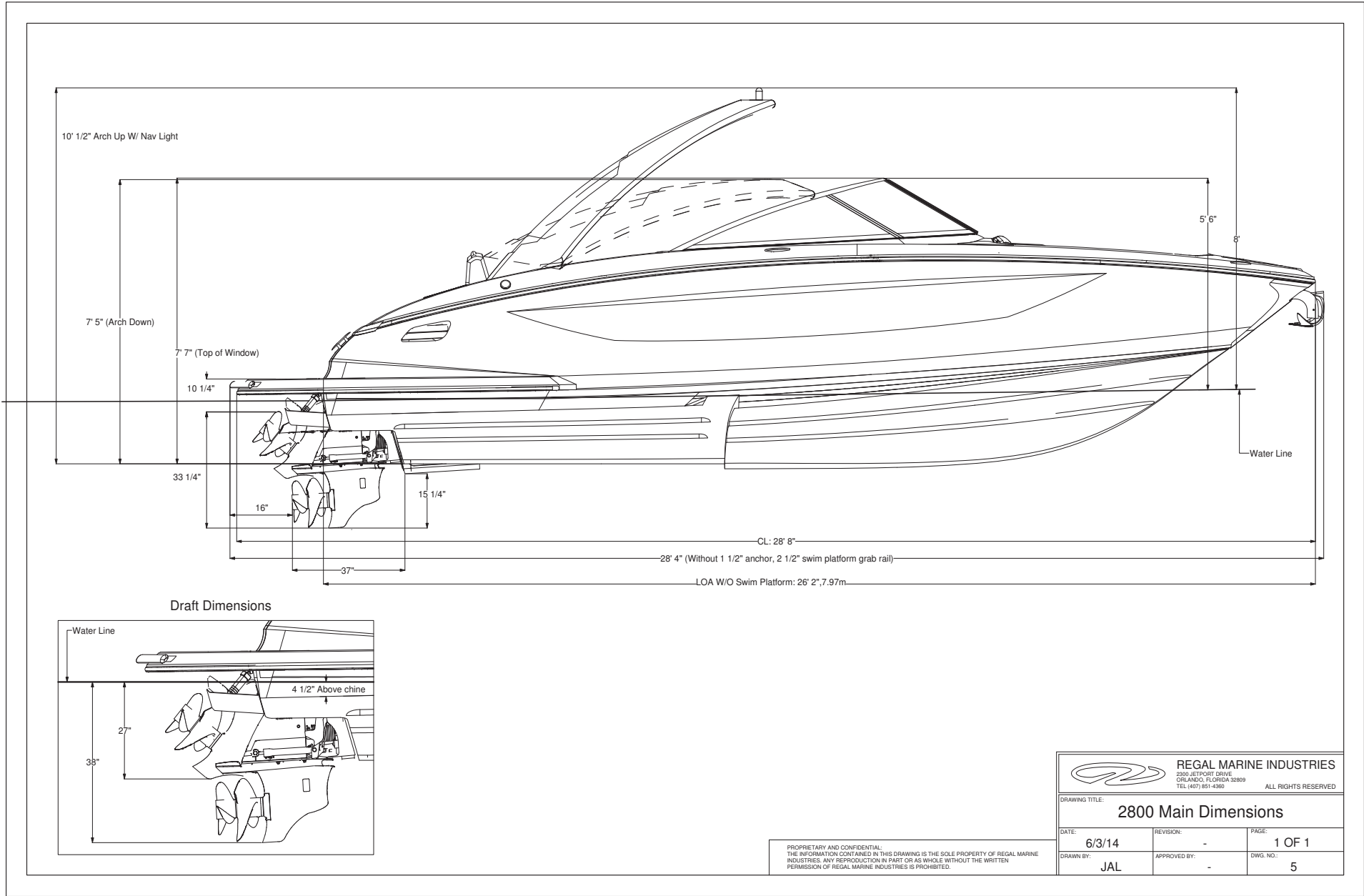

PROPRIETARY AND CONFIDENTIAL:  
THE INFORMATION CONTAINED IN THIS DRAWING IS THE SOLE PROPERTY OF REGAL MARINE INDUSTRIES. ANY REPRODUCTION IN PART OR AS WHOLE WITHOUT THE WRITTEN PERMISSION OF REGAL MARINE INDUSTRIES IS PROHIBITED.

 <b>REGAL MARINE INDUSTRIES</b> 2300 LEBROFT DRIVE ORLANDO, FLORIDA 32809 TEL (407) 851-4360		
ALL RIGHTS RESERVED		
DRAWING TITLE:		
<b>2800 Deck Hardware</b>		
DATE:	REVISION:	PAGE:
6/3/14	-	2 OF 2
DRAWN BY:	APPROVED BY:	DWG. NO.:
JAL	-	14

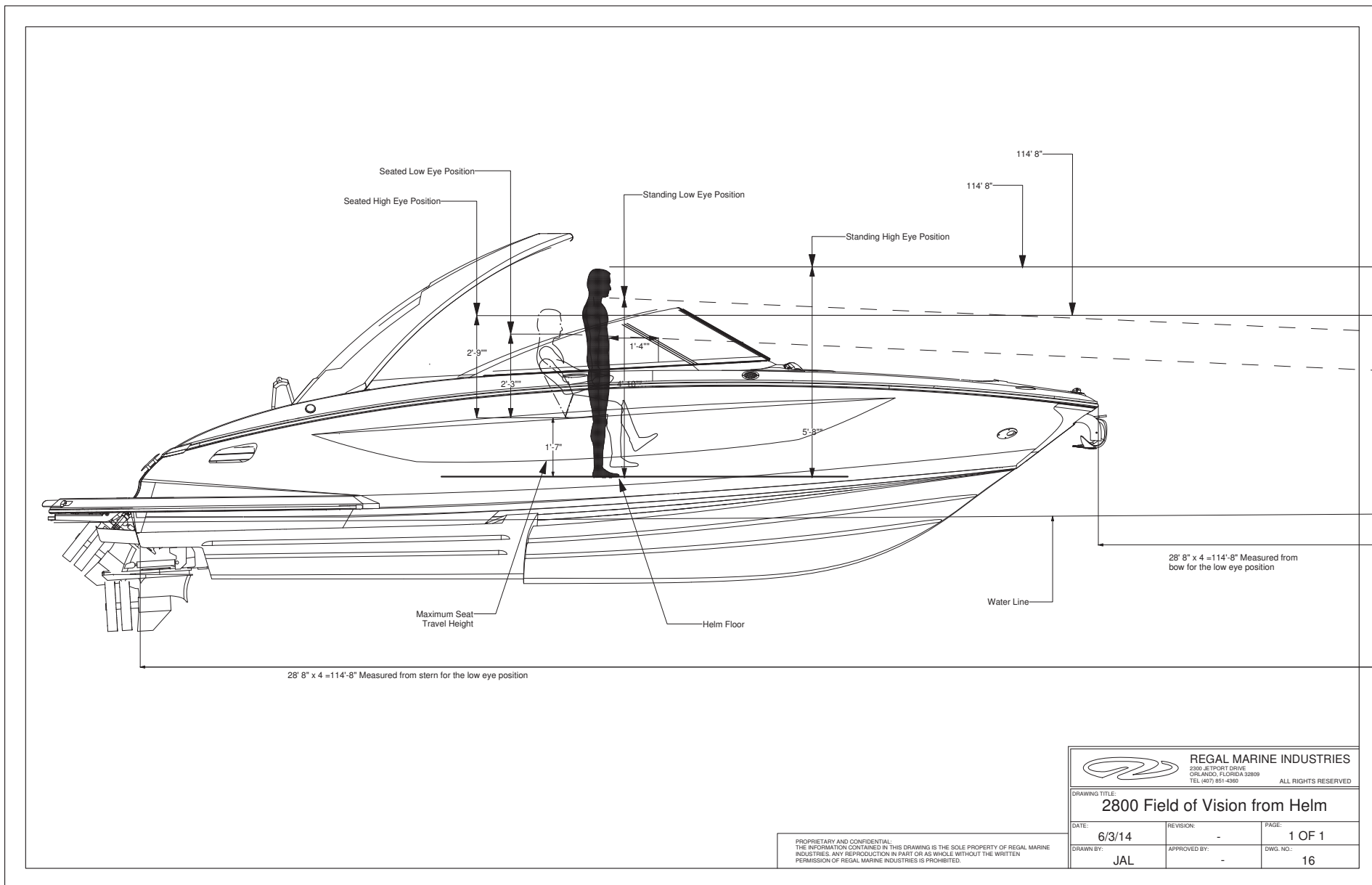

# 2800 BOW RIDER MAIN DIMENSIONS



 <b>REGAL MARINE INDUSTRIES</b> <small>2200 SE PORT DRIVE          ORLANDO, FLORIDA 32809          TEL (407) 881-4360</small>		
<b>DRAWING TITLE:</b> <b>2800 Field of Vision from Helm</b>		
<b>DATE:</b> 6/3/14	<b>REVISION:</b> -	<b>PAGE:</b> 1 OF 1
<b>DRAWN BY:</b> JAL	<b>APPROVED BY:</b> -	<b>DWG. NO.:</b> 16

PROPRIETARY AND CONFIDENTIAL:  
 THE INFORMATION CONTAINED IN THIS DRAWING IS THE SOLE PROPERTY OF REGAL MARINE  
 INDUSTRIES. ANY REPRODUCTION IN PART OR AS WHOLE WITHOUT THE WRITTEN  
 PERMISSION OF REGAL MARINE INDUSTRIES IS PROHIBITED.

# 2800 BOW RIDER FIELD OF VISION FROM HELM

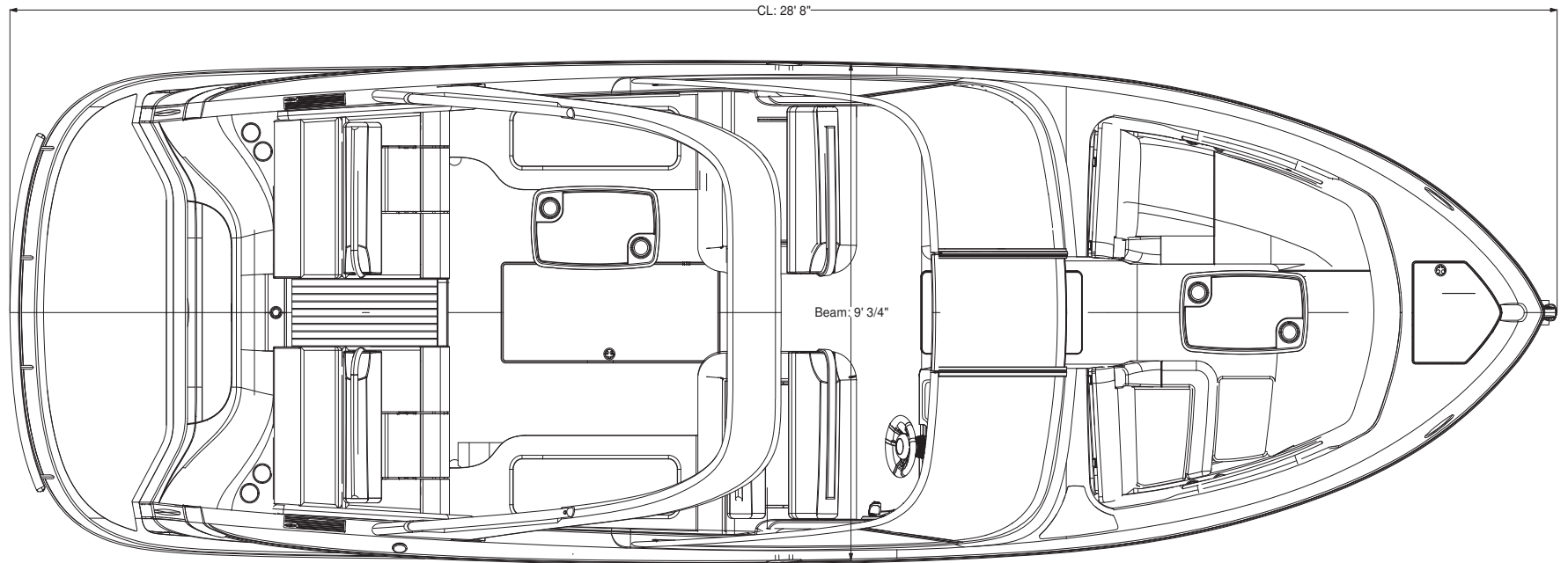

PROPRIETARY AND CONFIDENTIAL:  
 THE INFORMATION CONTAINED IN THIS DRAWING IS THE SOLE PROPERTY OF REGAL MARINE INDUSTRIES. ANY REPRODUCTION IN PART OR AS WHOLE WITHOUT THE WRITTEN PERMISSION OF REGAL MARINE INDUSTRIES IS PROHIBITED.

 <b>REGAL MARINE INDUSTRIES</b> 2300 JETPORT DRIVE ORLANDO, FLORIDA 32809 TEL (407) 851-4362 ALL RIGHTS RESERVED		
DRAWING TITLE: <b>2800 Deck Plan</b>		
DATE: <b>6/3/14</b>	REVISION: -	PAGE: <b>1 OF 1</b>
DRAWN BY: <b>JAL</b>	APPROVED BY: -	DWG. NO.: <b>1</b>

# 2800 BOW RIDER DECK PLAN

NOTES:

1. THRU BOLT IN ENGINE COMPARTMENT, ANCHOR LOCKER AND IN ANY OTHER ACCESSIBLE LOCATIONS, OR UNLESS SPECIFIED.
2. SCREW TOGETHER REMAINING LOCATIONS EVERY 6 TO 8 INCHES.
3. SEAL HULL DECK SHEER AS APECIFIED ON WS047

SEE NOTE 1

SEE NOTE 2

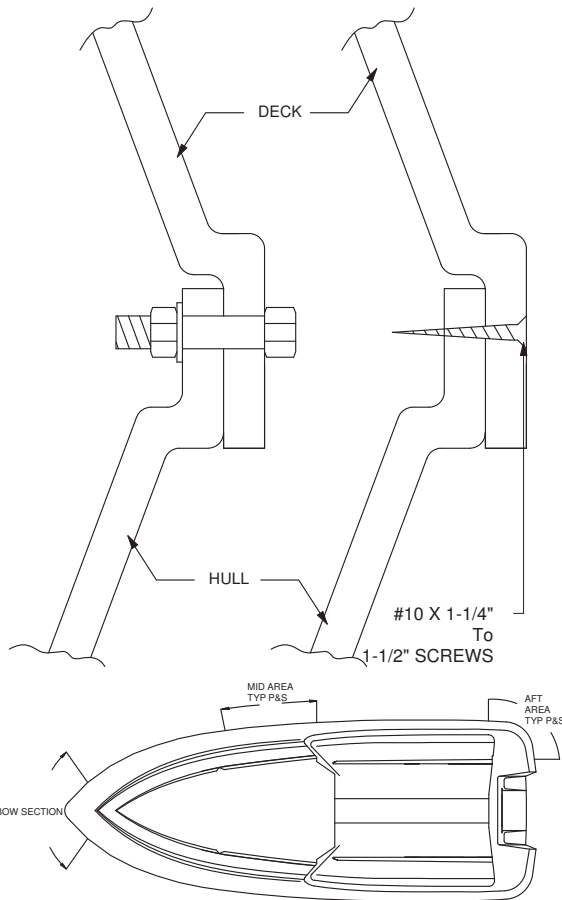

Boats 19'-27'

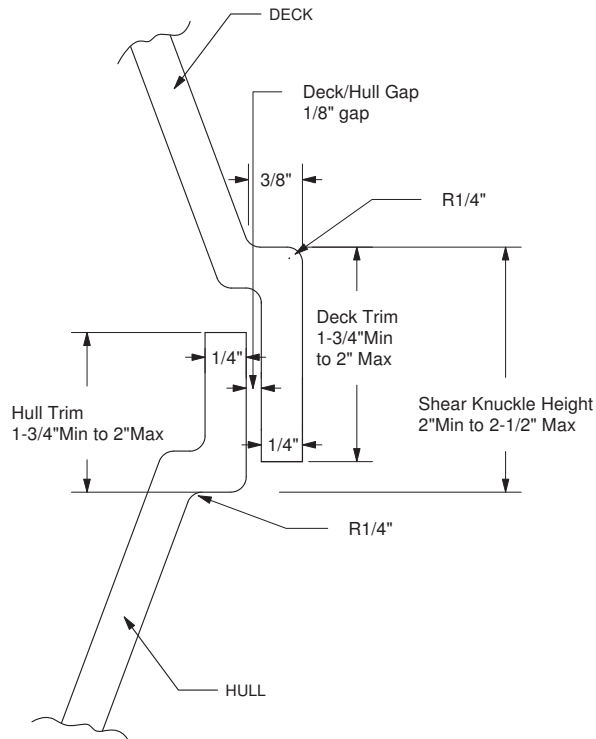

Boats 28'-46'

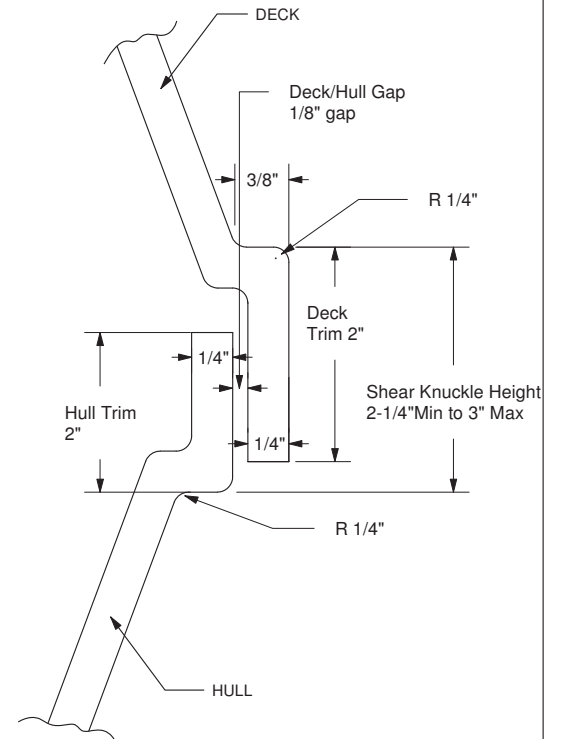

PROPRIETARY AND CONFIDENTIAL:  
THE INFORMATION CONTAINED IN THIS DRAWING IS THE SOLE PROPERTY OF REGAL MARINE INDUSTRIES. ANY REPRODUCTION IN PART OR AS WHOLE WITHOUT THE WRITTEN PERMISSION OF REGAL MARINE INDUSTRIES IS PROHIBITED.

 <b>REGAL MARINE INDUSTRIES</b> 2300 JETPORT DRIVE ORLANDO, FLORIDA 32809 TEL (407) 951-4360		
DRAWING TITLE: <b>2800 Hull Deck Joint Detail</b>		
DATE: <b>6/3/14</b>	REVISION: -	PAGE: <b>1 OF 1</b>
DRAWN BY: <b>JAL</b>	APPROVED BY: -	DWG. NO.: <b>13</b>

2800 BOW RIDER HULL DECK JOINT DETAIL

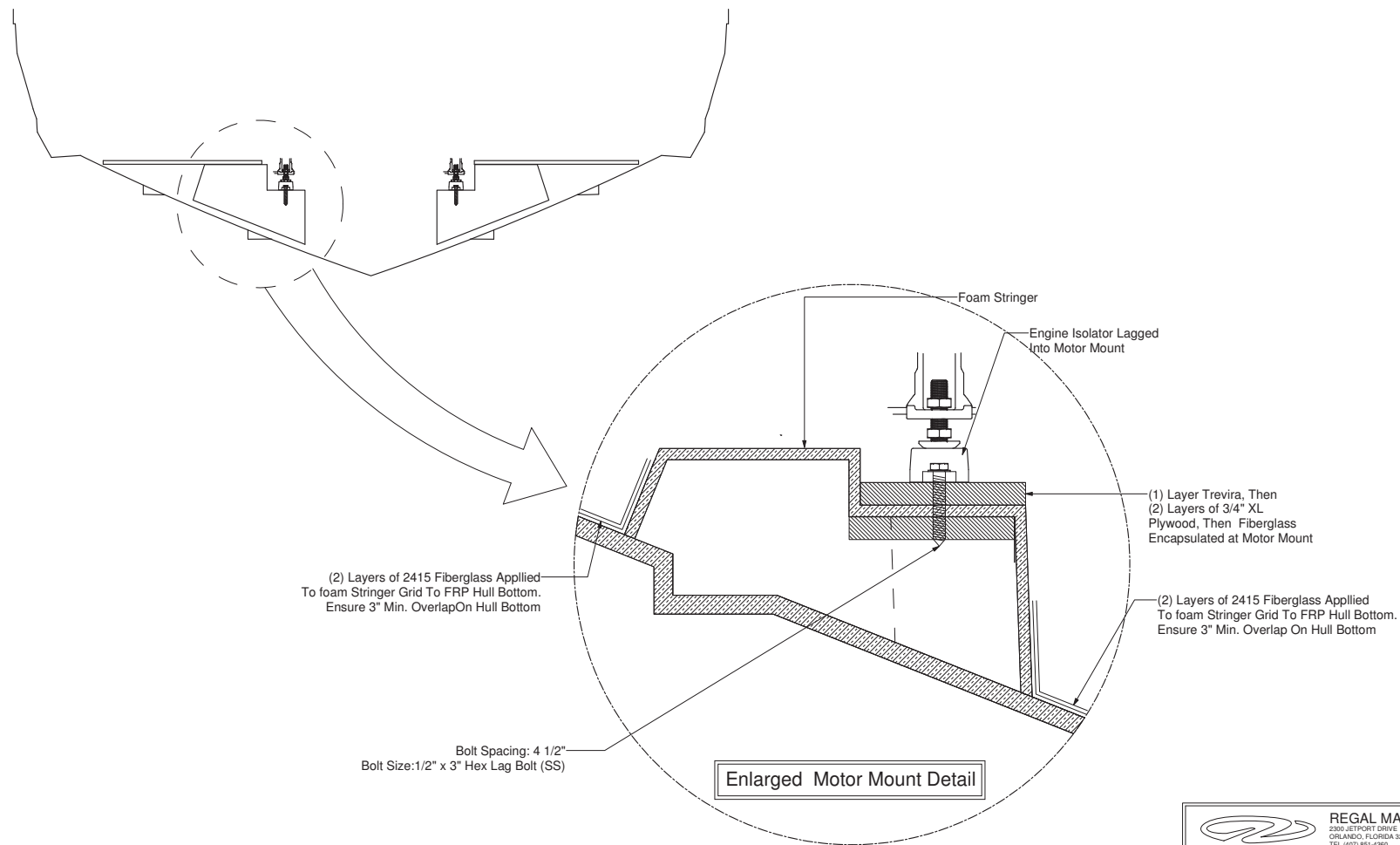



 <b>REGAL MARINE INDUSTRIES</b> 2300 JETPORT DRIVE ORLANDO, FLORIDA 32809 TEL (407) 851-4360 ALL RIGHTS RESERVED		
DRAWING TITLE:		
<b>2800 Motor Mount Detail</b>		
DATE:	REVISION:	PAGE:
6/3/14	-	1 OF 1
DRAWN BY:	APPROVED BY:	DWG. NO.:
JAL	-	11

PROPRIETARY AND CONFIDENTIAL:  
 THE INFORMATION CONTAINED IN THIS DRAWING IS THE SOLE PROPERTY OF REGAL MARINE  
 INDUSTRIES. ANY REPRODUCTION IN PART OR AS WHOLE WITHOUT THE WRITTEN  
 PERMISSION OF REGAL MARINE INDUSTRIES IS PROHIBITED.

# 2800 BOW RIDER MOTOR MOUNT DETAIL

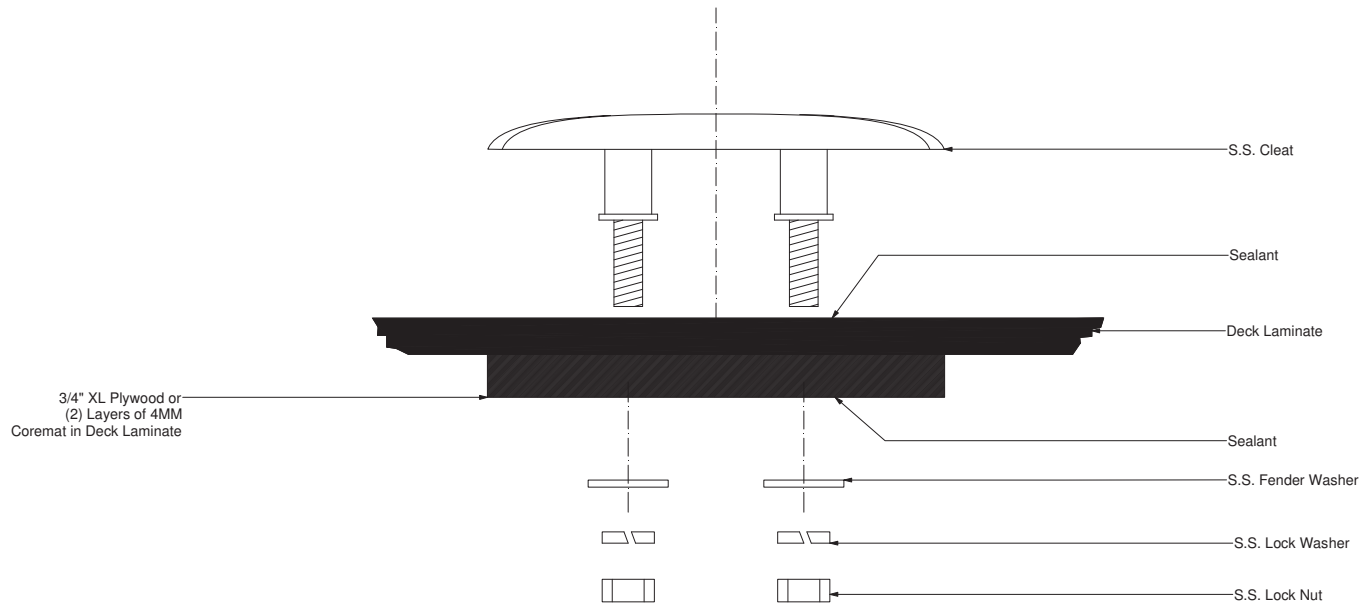
General Note:  
 Refer to the Workmanship Standard  
 WS004 for Hardware Sealing Requirements



 <b>REGAL MARINE INDUSTRIES</b> <small>2500 JETPORT DRIVE        ORLANDO, FLORIDA 32809        TEL (407) 851-4360</small>		
<small>ALL RIGHTS RESERVED</small>		
DRAWING TITLE:		
<b>2800 Strong Point Cleat Installation</b>		
DATE:	REVISION:	PAGE:
6/3/14	-	1 OF 1
DRAWN BY:	APPROVED BY:	DWG. NO.:
JAL	-	12

PROPRIETARY AND CONFIDENTIAL:  
 THE INFORMATION CONTAINED IN THIS DRAWING IS THE SOLE PROPERTY OF REGAL MARINE  
 INDUSTRIES. ANY REPRODUCTION IN PART OR AS WHOLE WITHOUT THE WRITTEN  
 PERMISSION OF REGAL MARINE INDUSTRIES IS PROHIBITED.

# 2800 BOW RIDER STRONG POINT CLEAT INSTALLATION







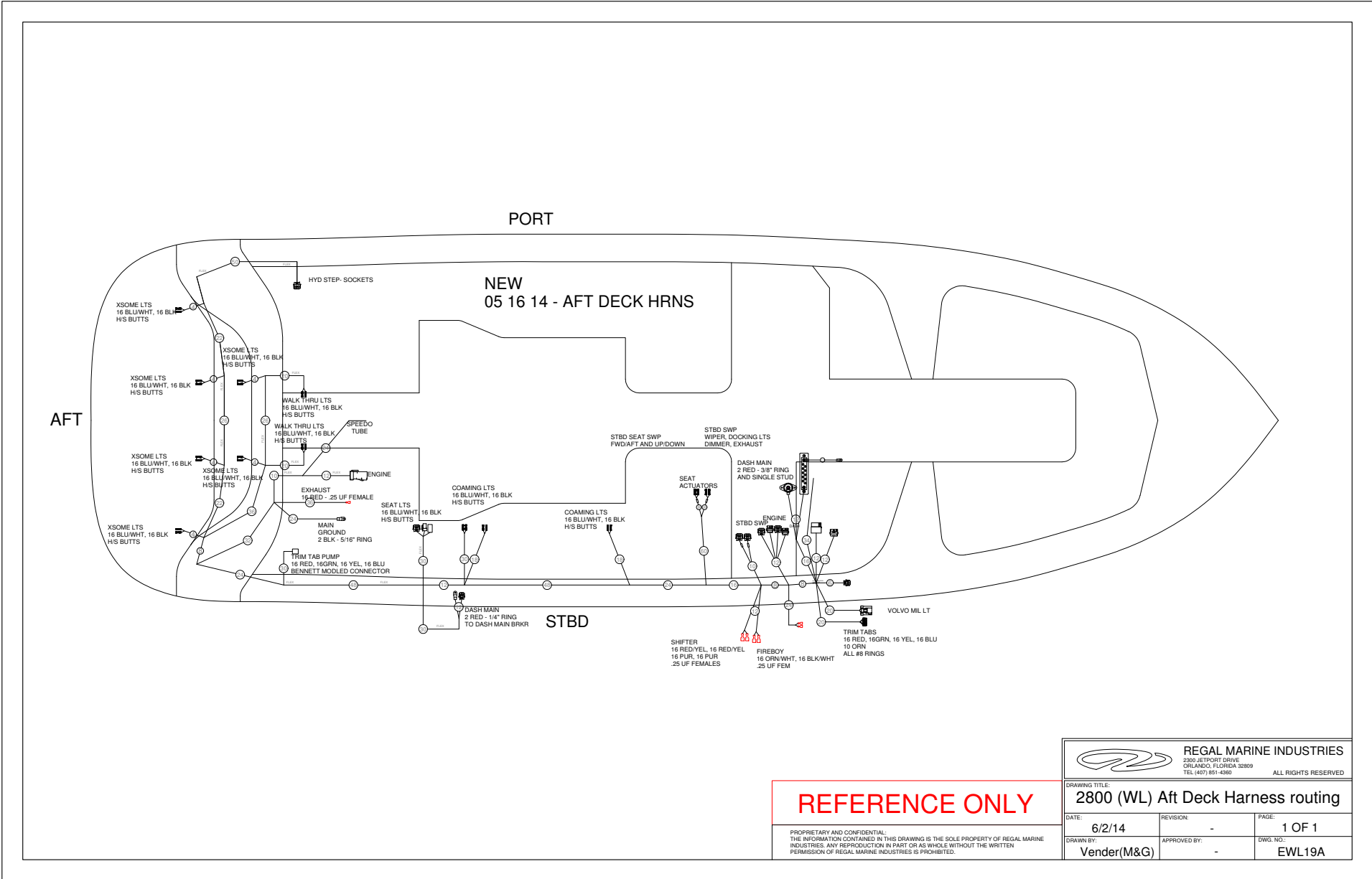

PORT

NEW  
05 16 14 - AFT DECK HRNS

AFT

STBD

**REFERENCE ONLY**

PROPRIETARY AND CONFIDENTIAL.  
THE INFORMATION CONTAINED IN THIS DRAWING IS THE SOLE PROPERTY OF REGAL MARINE INDUSTRIES. ANY REPRODUCTION IN PART OR AS WHOLE WITHOUT THE WRITTEN PERMISSION OF REGAL MARINE INDUSTRIES IS PROHIBITED.

 <b>REGAL MARINE INDUSTRIES</b> 2300 JETPORT DRIVE ORLANDO, FLORIDA 32809 TEL (407) 851-4360 ALL RIGHTS RESERVED		
DRAWING TITLE:		
2800 (WL) Aft Deck Harness routing		
DATE:	REVISION:	PAGE:
6/2/14	-	1 OF 1
DRAWN BY:	APPROVED BY:	DWG. NO.:
Vender(M&G)	-	EWL19A

2800 BOW RIDER AFT. DECK HARNESS OVERVIEW

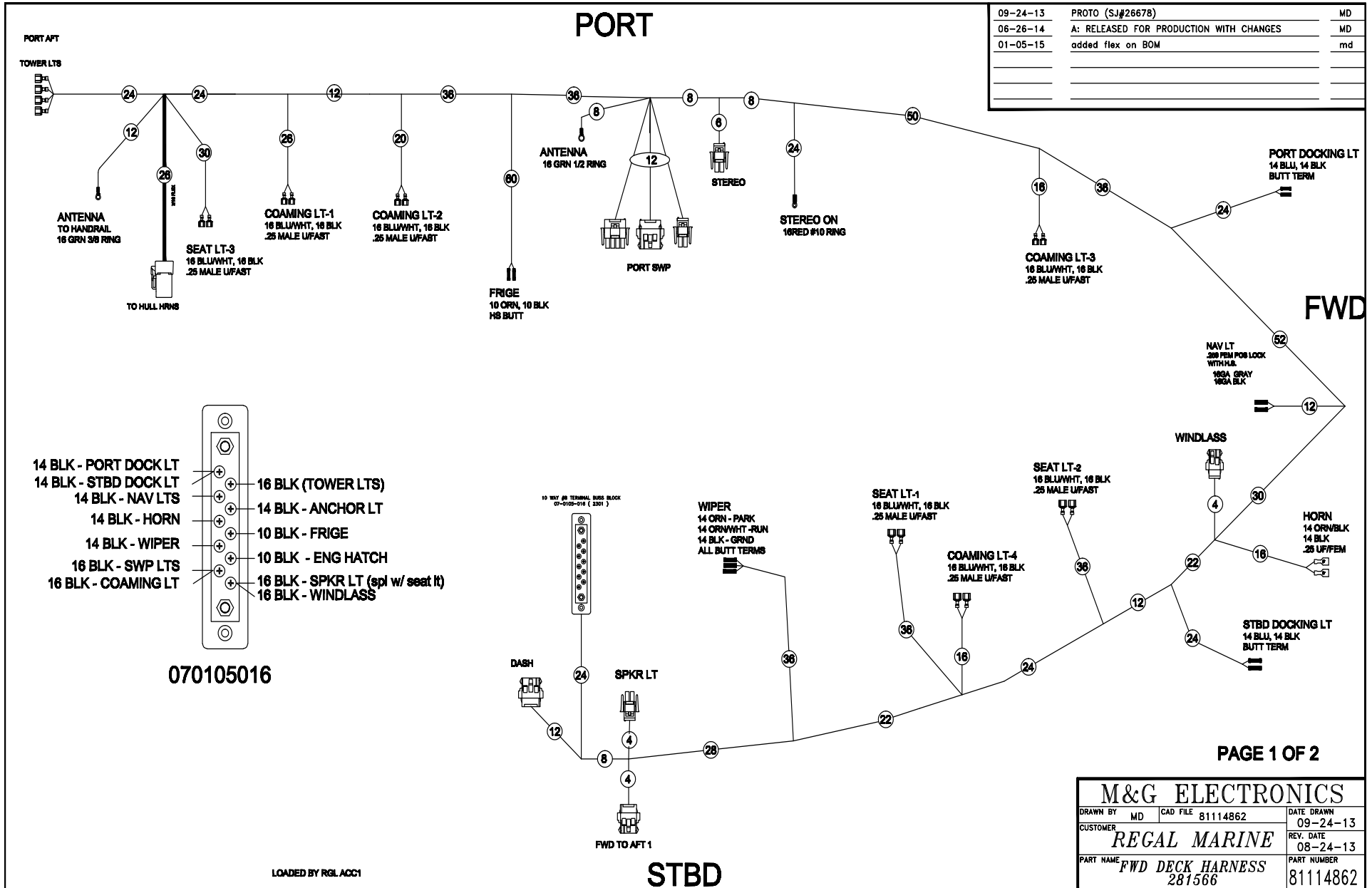

2800 BOW RIDER FWD. DECK HARNESS ROUTING

MPD HEAD HARNESS - 05 20 14  
 REGAL #281565  
 PORT

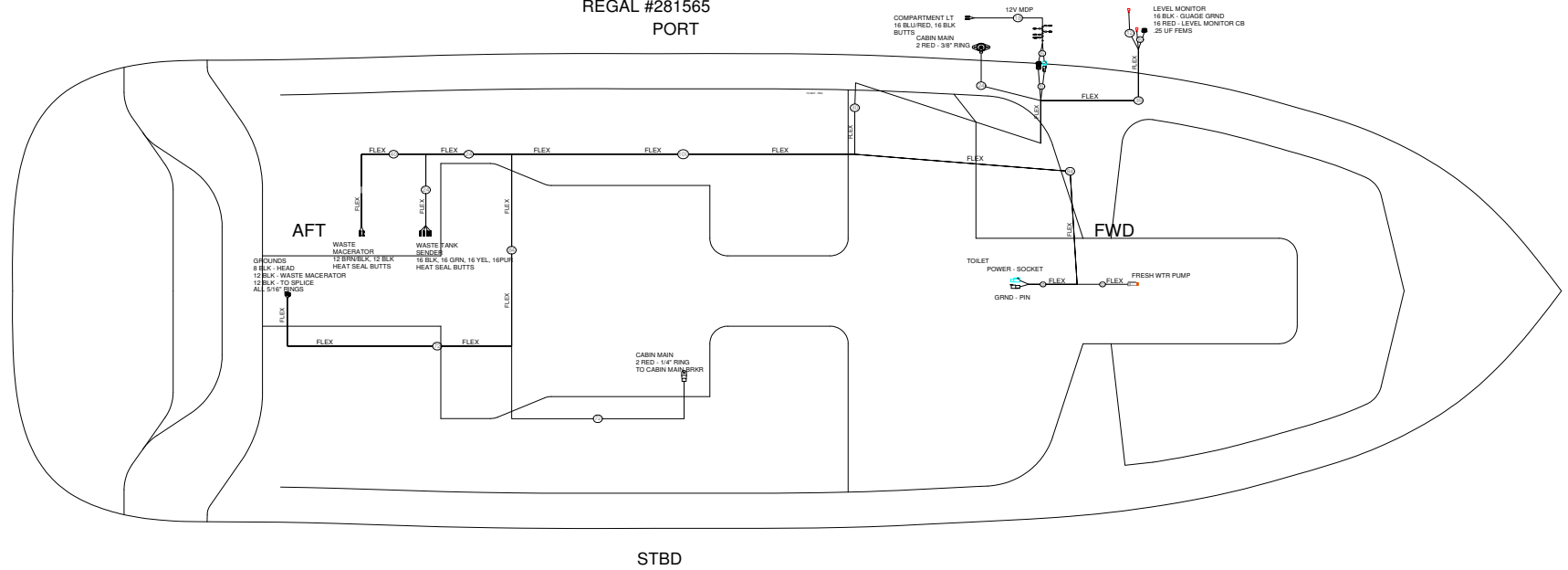

**REFERENCE ONLY**

PROPRIETARY AND CONFIDENTIAL  
 THE INFORMATION CONTAINED IN THIS DRAWING IS THE SOLE PROPERTY OF REGAL MARINE INDUSTRIES. ANY REPRODUCTION IN PART OR AS WHOLE WITHOUT THE WRITTEN PERMISSION OF REGAL MARINE INDUSTRIES IS PROHIBITED.

<b>REGAL MARINE INDUSTRIES</b> <small>2300 JETPORT DRIVE        ORLANDO, FLORIDA 32809        TEL (407) 851-4360</small>		
ALL RIGHTS RESERVED		
<b>DRAWING TITLE:</b>		
<b>2800 (WL) MEP Head Harness routing</b>		
<b>DATE:</b>	<b>REVISION:</b>	<b>PAGE:</b>
6/2/14	-	1 OF 1
<b>DRAWN BY:</b>	<b>APPROVED BY:</b>	<b>DWG. NO.:</b>
Vender(M&G)	-	EWL20A

# 2800 HEAD HARNESS ROUTING

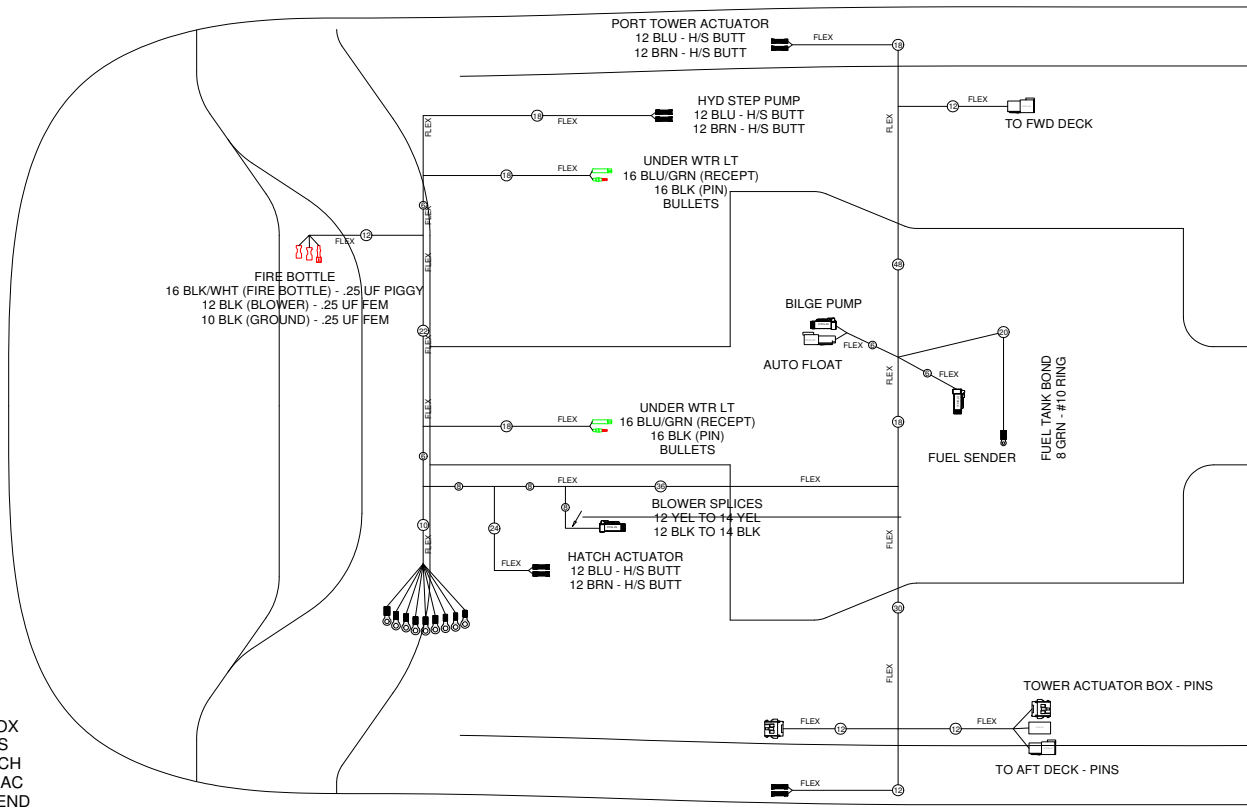

- GROUND BUSS
- 8 GRN - FUEL TANK BOND
- 10 BLK - FIRE BOTTLE
- 14 BLK - BILGE PUMP
- 16 BLK - FUEL SENDER
- 16 BLK - UNDER WTR LTS
- 12 BLK - TOWER
- 12 BLK - TOWER
- 12 BLK - TOWER
- 12 BLK - TOWER
- 12 BLK - TOWER
- TO TOWER ACTUATOR BOX
- 12-WAY MNLII CAP - PINS
- 1 - 16 RED - TOWER SWITCH
- 2 - 16 GRN - TOWER RETRAC
- 3 - BLU/WHT - TOWER EXTEND
- 4 - BLANK
- 5 - 12 BRN - PORT ACTUATOR
- 6 - 12 BLU - PORT ACTUATOR
- 7 - 12 BRN - STBD ACTUATOR
- 8 - 12 BLU - STBD ACTUATOR
- 9 - 12 BLK - GRND
- 10 - 12 BLK - GRND
- 11 - 12 BLK - GRND
- 12 - 12 BLK - GRND

REFERENCE ONLY

PROPRIETARY AND CONFIDENTIAL:  
THE INFORMATION CONTAINED IN THIS DRAWING IS THE SOLE PROPERTY OF REGAL MARINE INDUSTRIES. ANY REPRODUCTION IN PART OR AS WHOLE WITHOUT THE WRITTEN PERMISSION OF REGAL MARINE INDUSTRIES IS PROHIBITED.

<b>REGAL MARINE INDUSTRIES</b> <small>2300 JETPORT DRIVE ORLANDO, FLORIDA 32809 TEL (407) 851-4360</small>		ALL RIGHTS RESERVED
DRAWING TITLE: <b>2800 WL Sump Harness routing</b>		
DATE:	REVISION:	PAGE:
6/2/14	-	1 OF 1
DRAWN BY:	APPROVED BY:	DWG. NO.:
Vender(M&G)	-	EWL20B

## 2800 SUMP HARNESS ROUTING

10-11-13	PROTO	MD
5-23-14	RE-PROTO X10 (S#27119)	MD
06-23-14	A: RELEASED FOR PRODUCTION W/ CHANGED	MD
08-11-14	UPDATE AMP PWR WIRE COLOR TO ORN	MD

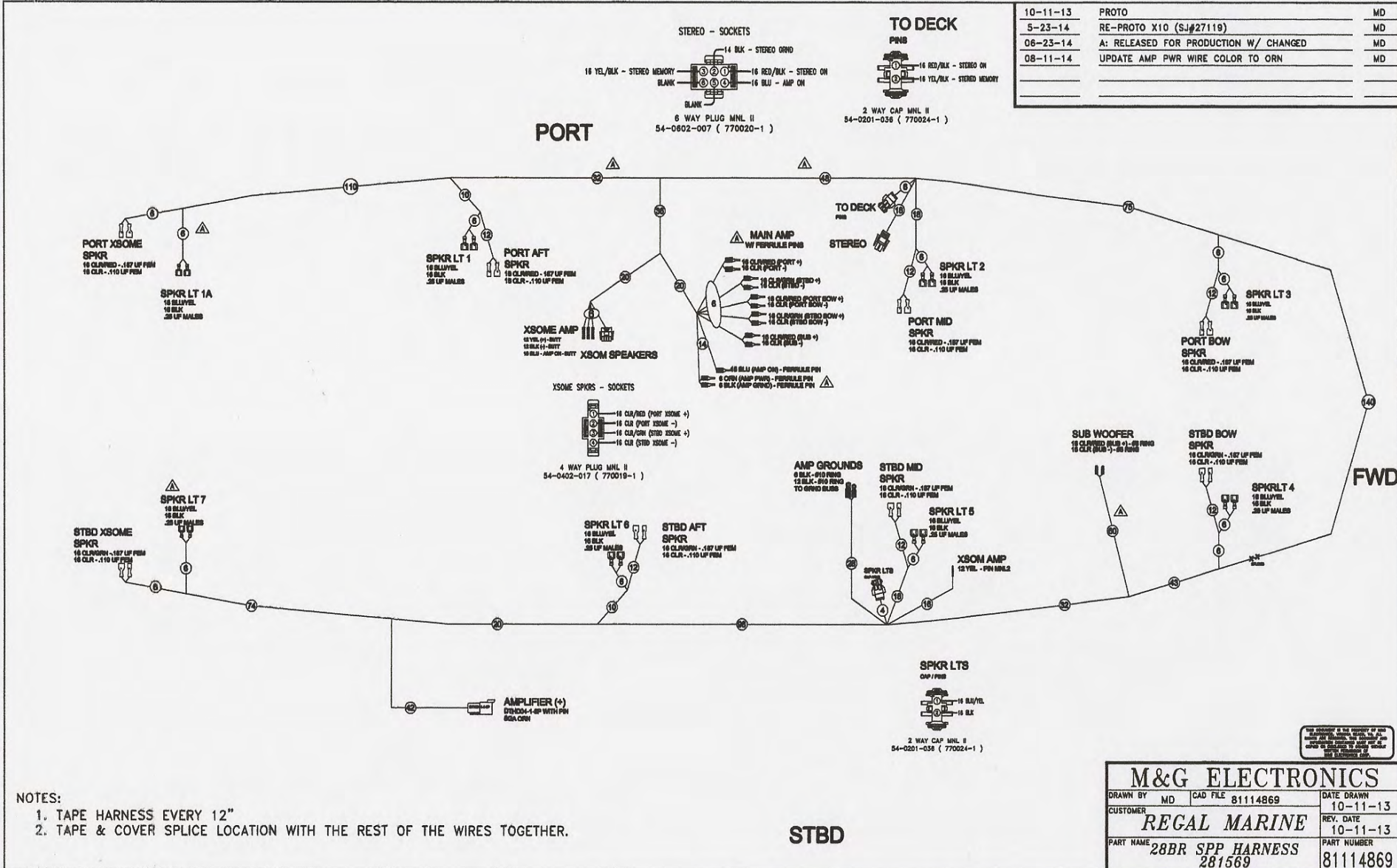

- NOTES:
1. TAPE HARNESS EVERY 12"
  2. TAPE & COVER SPLICE LOCATION WITH THE REST OF THE WIRES TOGETHER.

M&G ELECTRONICS			
DRAWN BY	MD	CAD FILE	81114869
CUSTOMER	REGAL MARINE		DATE DRAWN
			10-11-13
			REV. DATE
			10-11-13
PART NAME	28BR SPP HARNESS		PART NUMBER
281569			81114869

# 2800 AUDIO HARNESS ROUTING

1 changed screen on panel face, breaker change, wire change due to fwd bilge 1/31/2012  
 2 changed windlass breaker from 90A to 40A 6/16/2014

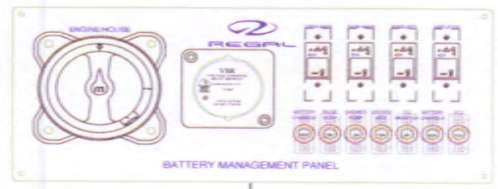
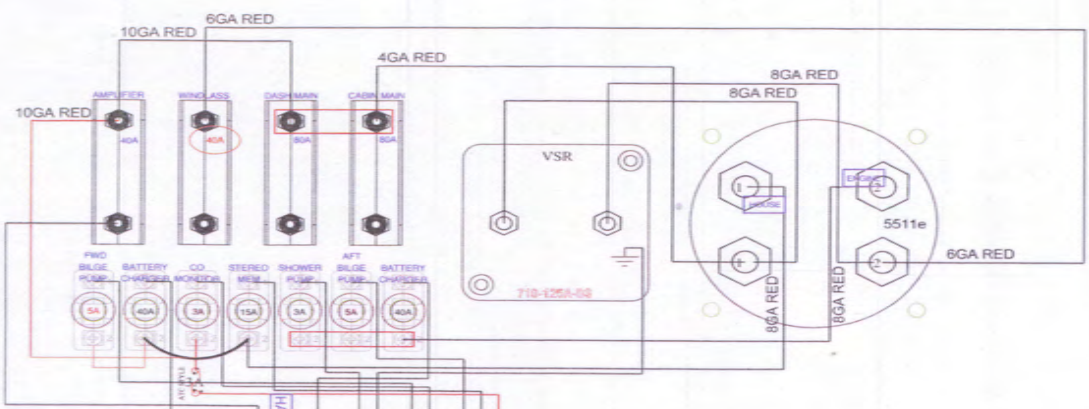

14"

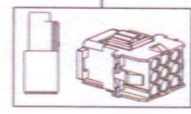

- DTHD04-1-8P 8GA RED CHARGER STBD
- DTHD06-1-8S 8GA ORANGE
- DTHD04-1-8P 8GA RED
- 1) 16GA BROWN/BLACK
- 2) 16GA BLACK
- 3) 14GA BROWN/RED
- 4) 16GA BROWN/PINK
- 5) 14GA BROWN/WHITE
- 6) 16GA YELLOW/BLACK
- 7) 16GA ORANGE/WHITE

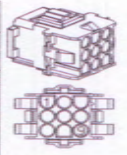

770028-01 CAP WIPINS



6891 N.W. 73rd COURT  
 Miami, FL. 33166  
 Ph. 305-888-7709  
 Fax 305-888-7285

REGAL MARINE

TITLE			
BATTERY MANAGEMENT PANEL			
SIZE	CAGE CODE	DWG NO	REV
A		281237	
SCALE		SHEET	

R MARTIN

2800 BATTERY MANAGEMENT PANEL



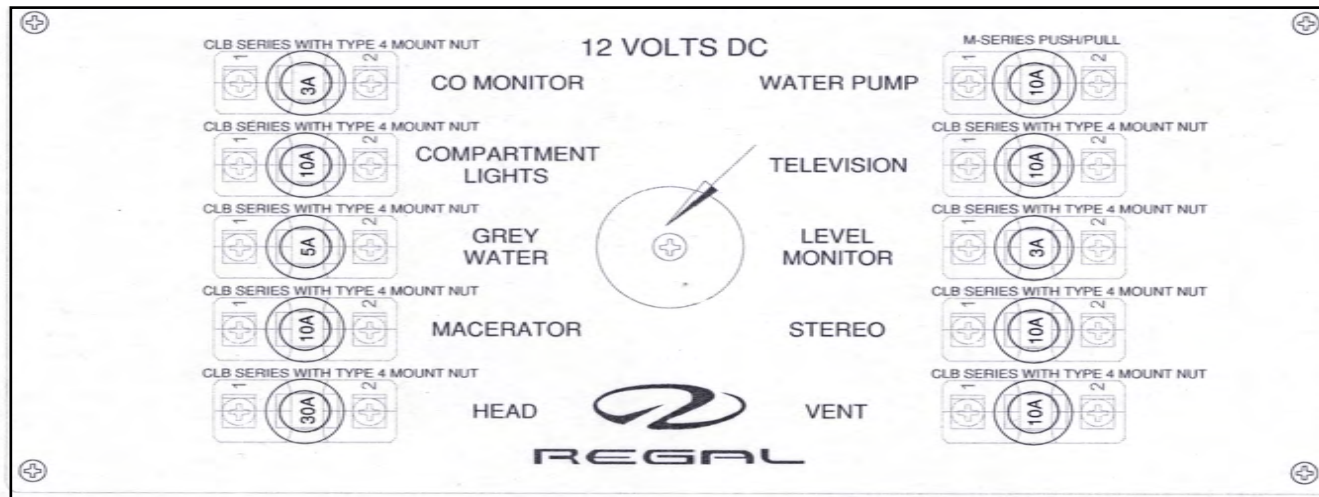

 <p>6891 N.W. 73rd COURT Miami, FL 33166 Ph. 305-888-7709 Fax 305-888-7285</p>		<b>REGAL MARINE</b>			
		TITLE DC PANEL			
SIZE	CAGE CODE	DWG NO	PN#	REV	
SCALE			SHEET		

2800 BOW RIDER DC PANEL