



**REGAL OWNER'S MANUAL**  
**36 GRAND COUPE/36 OUTBOARD**



JULY 2020 EDITION

# Important Notes

## FUEL SYSTEMS

Boats manufactured for use in California for model year 2018 and after meet the California EVAP Emissions regulation for spark-ignition marine watercraft. Boats meeting this requirement will have a label affixed near the helm.

 **WARNING**

Operating, servicing and maintaining a recreational marine vessel can expose you to chemicals including engine exhaust, carbon monoxide, phthalates, and lead, which are known to the State of California to cause cancer and birth defects or other reproductive harm. To minimize exposure, avoid breathing exhaust, service your vessel in a well-ventilated area and wear gloves or wash your hands frequently when servicing this vessel. For more information go to: [www.P65warnings.ca.gov/marine](http://www.P65warnings.ca.gov/marine).

The fuel system in this boat complies with U.S. EPA mandated evaporative emission standards at time of manufacture using certified components. See the label below.

**EMISSIONS CONTROL SYSTEM INFORMATION  
MEETS U.S. EPA EVAP STANDARDS USING CERTIFIED  
COMPONENTS AND MEETS 2021 MY CALIFORNIA EVAP  
EMISSIONS REGULATIONS FOR SPARK-IGNITION  
MARINE WATERCRAFT**

MANUFACTURER: REGAL MARINE INDUSTRIES, INC.  
MODEL: ·

CALIFORNIA EVAP FAMILY: MRMIPVSSL002  
EMISSION CONTROL SYSTEM: CM

REGAL # 212226

*Note the YYYY MY (model year) along with the California Evap Family first Letter in the Family grouping changes annually in this label.*

**NOTE AS PART OF REGAL'S COMMITMENT TO PRODUCT IMPROVEMENT SPECIFICATIONS, COMPONENTS, AND LOCATIONS DISPLAYED IN DRAWINGS AND/OR DOCUMENTATION MAY CHANGE AT ANY TIME. SELECT COMPONENTS ARE OPTIONAL AND MAY NOT BE INSTALLED ON YOUR VESSEL.**

## MANUFACTURER'S WARRANTY

This evaporative emission control system is warranted for two years. If any evaporative emission-related part on your spark-ignition marine watercraft is defective, the part will be repaired by Regal Marine Industries, Inc.

## OWNER'S MANUAL RESPONSIBILITIES

- As the spark-ignition marine watercraft owner, you are responsible for the performance of the required maintenance listed in your owner's manual. Regal Marine Industries, Inc. recommends that you retain all receipts covering maintenance on your spark-ignition marine watercraft, but Regal Marine Industries, Inc. cannot deny warranty solely on the lack of receipts.
- As the owner, you should be aware that Regal Marine Industries, Inc. may deny you warranty coverage of your spark-ignition marine watercraft or a part has failed due to abuse, neglect, or improper maintenance or unapproved modifications.
- You are responsible for presenting your spark-ignition marine watercraft to a Regal Marine Industries, Inc. distribution center or a service center as soon as the problem exists. The warranty repairs should be completed in a reasonable amount of time, not to exceed 30 days. If you have any questions regarding your warranty coverage, you should contact Regal Marine Industries, Inc. at 407-851-4360.



# Introduction

Boating is becoming more popular each and every year. There are numerous types of recreational vessels on our waterways today involved in an every growing number of activities. Therefore, as a Regal boat owner it is of the highest priority to learn about general boating practices before operating your vessel.

Your Regal dealer will answer many questions and provide valuable “hands on” information during the completion of the new boat delivery process. In addition, your dealer has received special factory training on the product line and his services should be employed to solve any technical problems and periodic maintenance beyond the scope of this manual. Your Regal dealer carries a line of factory approved parts and accessories.

Your Regal dealer can provide information regarding national training organizations such as the U.S. Power Squadron and United States Coast Guard Auxiliary. Along with other organizations and literature, they can help build your “boating savvy” by developing the necessary skills and awareness to be a safe and confident skipper.

Also, your local library can assist in providing recommended boating literature such as Chapman Piloting Seamanship & Boat Handling by Elbert S. Maloney. Also, boating information is available on the internet.

Remember, waterway conditions can change in a heartbeat. Knowing how to react quickly comes from experience and knowledge which can be gained through boating education.

Welcome aboard!

# Welcome to Regal

I know I speak for everyone at Regal when I welcome you to the ever-growing family of Regal boat owners. You've chosen a boat that is recognized worldwide for its standard of excellence. Each step in construction has been carefully scrutinized to assure safety, performance, reliability and comfort for both your passengers and yourself.

Your yacht is certified by the National Marine Manufacturers Association. It also complies with the applicable standards set by the United States Coast Guard , American Boat and Yacht Council and the International Marine Certification Institute. Your Regal boat was built with the same attention to detail and quality of construction that we would expect in a craft we would purchase ourselves.

Whether you're a veteran boater or a newcomer, we strongly urge you to read this owner's manual thoroughly. Familiarize yourself with the various components of your vessel, and heed the safety precautions noted herein.

If you have questions that are not covered in this manual, please consult your authorized Regal dealer for assistance, phone the Regal factory at 407-851-4360 or E-mail us at [www.regalboats.com](http://www.regalboats.com).

Thank you, and welcome to the "World of Regal !"

Duane Kuck  
President & CEO

## Our Mission

With God's Help and a Steadfast Commitment to Integrity,  
We will Develop a Team of Exceptional People and Relationships  
to Provide Exceptional Customer Satisfaction.



# Table Of Contents

<b>2</b>	Important Notes
<b>3</b>	Introduction
<b>4</b>	Welcome to Regal
<b>4</b>	Our Mission
<b>6</b>	Chapter 1 - General Vessel Information
<b>18</b>	Chapter 2 - Safety On Board
<b>43</b>	Chapter 3 - Rules Of The Road
<b>54</b>	Chapter 4 - Systems
<b>150</b>	Chapter 5 - Engine/Controls-Notes
<b>151</b>	Engine (Stern Drive) & Controls
<b>171</b>	Engine (Outboard) & Controls
<b>201</b>	Chapter 6 - Vessel Operation
<b>216</b>	Chapter 7 - Auxiliary Equipment Operation
<b>268</b>	Chapter 8 - Cosmetic Care & Maintenance
<b>302</b>	Chapter 9 - Troubleshooting
<b>309</b>	Chapter 10 - Storage & Winterization
<b>314</b>	Chapter 11- Glossary & Index
<b>320</b>	Chapter 12 - Technical Information/Drawing Notes
<b>322</b>	36 Grand Coupe/36 Outboard Common Drawings
<b>356</b>	36 Outboard Only Drawings
<b>393</b>	36 Grand Coupe Only Drawings

# Chapter 1

## General Vessel Information

### Regal Owner's Manual

Your Regal owner's manual has been compiled with information to assist you in operating your craft with safety and pleasure. This manual targets specific details of Regal related systems and components along with their location, operation and maintenance that normally are not found in the vendor information. In addition, supplier related equipment information is located within the owner's information packet.

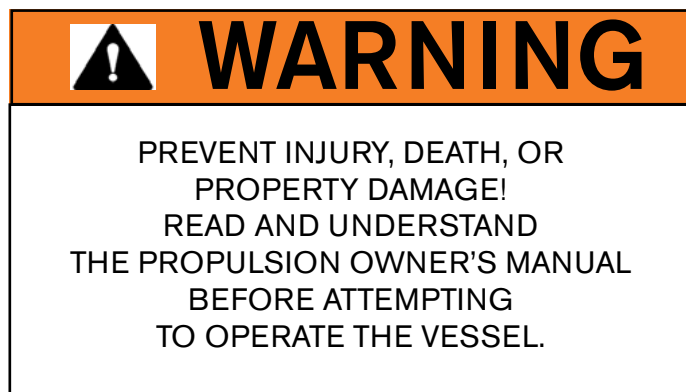

The Regal owner's manual is not to be thought of as a complete shop technical document. Besides the system chapters, there is troubleshooting information devoted to select current standard and optional equipment. In addition, refer to the engine and generator (if installed) operator's manuals. More detailed information may exist in the owner's packet associated with that component.

Remember that your Regal dealer has received special factory training and his services should be employed to solve more technical problems.

Call 407-851-4360 or go to the internet at [regalboats.com](http://regalboats.com) to find the closest Regal dealership.

In keeping with its commitment to improvement Regal Marine Industries, Inc. is continually upgrading the product line. Regal notes that all dimensions, specifications, models, standard and optional equipment is subject to change without notice at any time.

### Regal Owner's Manual QR Label



Currently there is a QR label attached to a visible location such as the helm or cabin. This label when scanned by an I phone will take you via an app to the Regal web-site where you can download

your models owner's manual or for that matter any Regal owner's manual.

With the manual downloaded you can duplicate it into a format you are comfortable using. The QR label is used globally for any type product from the food, home and auto business to boats. It affords much more capacity and is much more customer friendly than the traditional bar code used by manufacturer's on their products. *Other Regal owner's manuals can be found by scanning this QR Code or by going to: [regalboats.com/owners](http://regalboats.com/owners)*



## Owner's Information Packet



An owner's information packet (black satchel) is typically located on the vessel. Read and become familiar with the materials. This packet contains valuable information on your propulsion package, standard and optional equipment, systems, care and maintenance along with component warranty. Store the information packet in a clean, dry location on the vessel.

## Vessel Information Sheet

It is recommended that you fill out the information on the following page. It will supply vital statistics on your vessel.

## ABYC Yacht Plate



In proximity to the helm on Regal boats over 26' in length is a NMMA (National Marine Manufacturer's Association) yacht plate. This plate recognizes that your vessel was built to ABYC design compliance standards in effect on the date the certification was verified. The plate also states that your vessel complies with United States Coast Guard safety system standards in effect on the date of certification.

Note: Overloading, improper loading and weight distribution are well documented causes of accidents. Provide for an extra margin of safety in rough sea conditions.

## Hull Identification Number

The United States Coast Guard has established a universal system of numerically recognizing vessels by using a hull identification number or "HIN." This number identifies your Regal yachts' model, hull number, month and year of manufacture. The



HIN is normally found on your boat's hull on the starboard hull side, just below the rub rail. The HIN

is stamped on a plate and reinforced with a special adhesive. The HIN consists of 12 alpha or numeric characters.

It is recommended that you locate and write down the HIN for future reference. It can be especially useful when ordering parts from your Regal dealer. A second HIN number is found in a hidden location. This second HIN is useful to authorities if the vessel is stolen and/or the original transom HIN is modified or eliminated.

## Vessel Float Plan

Formulate the float plan on the following page before departing. Leave it with a responsible person who will notify the United States Coast Guard or local law enforcement authorities if you do not return as planned. If you change your plans be sure to notify this person. Make copies of the float plan and use one each time you go boating. This will help people know where to find you should you not return on schedule. Do not file the float plan with the United States Coast Guard.

## Vessel Information Sheet

Owner: \_\_\_\_\_

Address: \_\_\_\_\_

City & State: \_\_\_\_\_ Zip Code: \_\_\_\_\_

Cell Phone: \_\_\_\_\_ Business Phone: \_\_\_\_\_

In Case Of Emergency Notify: \_\_\_\_\_

Address \_\_\_\_\_

City & State \_\_\_\_\_

Phone \_\_\_\_\_

Insurance Agent's Name: \_\_\_\_\_

Policy#: \_\_\_\_\_

USCG Phone: \_\_\_\_\_ Local Police: \_\_\_\_\_

Marina Name: \_\_\_\_\_ Slip (Dock#): \_\_\_\_\_

Marina Phone: \_\_\_\_\_ E-mail: \_\_\_\_\_

Hull Serial #: RGM \_\_\_\_\_

Key #: \_\_\_\_\_ Port Engine: Key # \_\_\_\_\_ Center Engine: Key # \_\_\_\_\_ Stbd. Engine

Key # \_\_\_\_\_ Cabin Door

Selling Dealer: \_\_\_\_\_

Address: \_\_\_\_\_

City & State: \_\_\_\_\_

Phone: \_\_\_\_\_ E-mail: \_\_\_\_\_

Servicing Dealer: \_\_\_\_\_

Address: \_\_\_\_\_

City & State: \_\_\_\_\_

Phone: \_\_\_\_\_ E-mail: \_\_\_\_\_

Service Mgr's Name: \_\_\_\_\_ Phone: \_\_\_\_\_



## Vessel Float Plan

Fill out this form before departure. Leave it with a responsible person who will notify the Coast Guard or police if you don't return as planned. If you change your plans be sure to notify this person. Make copies of the float plan and use one each time you go on a trip. This will help people know where to find you should you not return on schedule. Do not file this plan with the Coast Guard.

Owner: \_\_\_\_\_  
Address: \_\_\_\_\_  
City & State: \_\_\_\_\_  
Telephone#: \_\_\_\_\_  
\_\_\_\_\_

Person Filing Report: \_\_\_\_\_  
Name \_\_\_\_\_  
Telephone \_\_\_\_\_  
\_\_\_\_\_

Make Of Craft: \_\_\_\_\_  
Length \_\_\_\_\_ Boat Name \_\_\_\_\_  
Color \_\_\_\_\_ Trim \_\_\_\_\_ Hp \_\_\_\_\_  
Inboard \_\_\_\_\_ Stern Drive \_\_\_\_\_  
Hull I.D.# \_\_\_\_\_  
Documented Vessel # \_\_\_\_\_  
\_\_\_\_\_

Other Information \_\_\_\_\_  
\_\_\_\_\_  
\_\_\_\_\_  
\_\_\_\_\_

Safety Equipment Aboard: \_\_\_\_\_  
Life Jackets \_\_\_\_\_  
First Aid Kit \_\_\_\_\_  
Flares \_\_\_\_\_  
Flash Light \_\_\_\_\_  
VHF Radio \_\_\_\_\_  
Cell Phone \_\_\_# \_\_\_\_\_  
Computer \_\_\_Desk Top \_\_\_Lap Top\_\_\_  
E-mail address \_\_\_\_\_  
Food \_\_\_\_\_ Water \_\_\_\_\_

State Registration# \_\_\_\_\_  
Destination: \_\_\_\_\_  
Leave From \_\_\_\_\_  
Time Left \_\_\_\_\_  
Going To \_\_\_\_\_  
Fuel Capacity \_\_\_\_\_  
Est. Day Of Arrival \_\_\_\_\_  
\_\_\_\_\_  
Est. Time Of Arrival \_\_\_\_\_  
If Not Back By \_\_\_\_\_ o'clock Call Authorities

### Persons Aboard:

Name	Age	Address	Phone
_____	_____	_____	_____
_____	_____	_____	_____
_____	_____	_____	_____
_____	_____	_____	_____
_____	_____	_____	_____

\_\_\_\_\_ Use Other Side For Additional Persons

## Vessel Cruise Checklist

- Obtain a current weather update.
- Hoist the boat & periodically inspect the hull bottom and propellers for damage. Marine growth such as barnacles will affect performance and fuel efficiency. Check sacrificial anodes located on the propulsion unit, transom and engine. Replace anode if less than 2/3 remaining.
- Check the electrical system and all safety related equipment. Carry extra fuses. Ensure they are of the proper capacity and type.
- If your boat has been in the water, run the bilge pump until the flow of water stops.
- Check to see that all bilge water has drained and the drain plug is installed before launching. If your boat has been out of the water.
- Check that all required safety equipment is on board and in good working condition. Examples include personal flotation devices (PFD's), horn, bell, hand held fire extinguishers, and visual distress signals.
- Check fuel level. Fuel tanks should be filled to slightly less than capacity. Allow for fuel expansion. Remember the "one third rule".
- Open engine compartment. Inspect for fuel odors and visible leaks in the fuel, oil, coolant, exhaust and power steering systems.
- Check all fuel filters for the presence of water.
- Check fluid levels of engines, drives and generator (if applicable).
- Inspect engine for cracked hoses, worn or loose belts, and loose hardware.

## Recommended On Board Equipment

### Tools:

Allen Wrenches  
Jack Knife  
Phillips Screwdriver  
Regular & Needle Nose Pliers  
Combination Box & End Wrench Set  
Screwdriver Set (One With Various Tips)  
Side Cutters  
Ratchet & Socket Set  
Electrical Crimper,Cutter,Stripper Combo  
Hammer  
VOA Electrical Tester  
Water Pump Pliers  
Vise Grip Pliers  
Floating Flashlight/Lantern  
Oil/Fuel Filter Wrench  
Tape Rule

### Basic Gear & Supplies:

Tow Line  
Lubricating Oil, Liquid Wrench  
Mooring Lines  
Duct & Electricians Tape  
Dock Fenders  
Coolant (Engine Freshwater Side)  
Distress Signals  
Engine, Drive, Power Steering Oil  
First Aid Kit  
Boat Soap (Not Dish Soap)  
Boat Hook  
Woody Wax  
Charts & Plotting Instruments  
Vinyl Cleaner  
Emergency Food & Water  
Hydrogen Peroxide (AC Pans)  
Hand Held VHF Marine Radio

### Spare Parts:

Fuel Filters-Engines & Generator  
Poly V- Belt (See Engine Manual)  
Coolant For Engine Freshwater System  
Extra Light Bulbs  
Seawater Filter  
Fuses  
Propeller Set (See Dealer)  
Propeller Hardware  
Flashlight Batteries  
Engine Spare Parts  
Generator Spare Parts  
Air Filters-Engine & Generator  
Oil Filters-Engine, Generator  
Fuel Filters

Life Raft  
Bailer or Hand Pump  
Rust Stain Remover (Star Brite)  
Extra Hand Held Fire Extinguishers  
Corrosion Block  
Personal Floatation Devices  
Bilge Cleaner  
Clean Rags, Diapers- For Oil Leaks  
Nylon Windbreaker Suit  
Bug Spray  
Sunscreen (SPF 30+)  
Shop Vacuum (1 Gal. Cap. Wet-Dry)  
Bucket/Pans w/Lids-Draining/Storing  
Used Fluids  
Squeegee  
Mirror (For Inspection & Emergency Signaling)  
Binoculars

## Owner's Registration & Systems

Please note that your boat requires the proper registration by your authorized Regal dealer. To initiate the vessel warranty your dealer must complete the owner's registration form and systems checklist at the time of delivery. The owner must sign the paperwork to acknowledge that the dealer has reviewed the boat systems and warranty provisions with the owner. The owner should keep the original paperwork that features a temporary warranty registration. A warranty certificate will be sent several weeks after receipt of the paperwork at Regal World Headquarters.

## Dealer's Responsibility

Your vessel has undergone rigid quality assurance inspections before leaving the factory. In addition, your dealer has been trained to perform final pre-delivery checks and to service your Regal boat.

Your dealer's responsibilities include:

1. An orientation in the operation of your Regal boat including matters relating to the safe operation of the vessel.
2. Completion and mailing of your boat registration warranty form to Regal.
3. Location of vendor warranties, registration materials, owner's manual, operation, installation and maintenance instructions for auxiliary equipment supplied with or installed on your Regal boat.

## Owner's Responsibility

You are entitled to all the benefits and services outlined in your Regal warranty. However, you have certain responsibilities to ensure warranty satisfaction. These are:

To read the warranty materials and understand them fully.

To examine the vessel in detail at the time of delivery.

To apply the following: boating rules and regulations, safety equipment, environmental regulations, accident reports and warranty regulations terms and conditions.

To read thoroughly all literature supplied with your boat including this owner's manual and to follow the recommendations in the literature.

To provide proper maintenance and periodic servicing of your boat and equipment as set forth in the various manuals supplied.



## Customer Service

Take the time to write down your Regal dealer's phone number and E-mail address for future reference. Along with your Regal dealer information is a listing below of other phone numbers and web addresses which may prove useful.

Regal Dealer:

Phone: \_\_\_\_\_

E-mail: \_\_\_\_\_

Regal Marine Customer Service:

1-800-US REGAL (1-800-877-3425)

regal@regalboats.com

customer.service@regalboats.com

# REGAL MARINE INDUSTRIES, INC. LIMITED WARRANTY

Welcome to the Worldwide Family of Regal Owners! We are very pleased that you have chosen a Regal Powerboat!

This document is your Limited Warranty Registration Certificate and Statement of Limited Warranty. Please check the registration information section for accuracy. If this information is not correct or if you change your address at some future date, please notify us at the following address: Regal Marine Industries, Inc. Attention: Warranty Registrations, 2300 Jetport Drive, Orlando, Florida 32809; or e-mail [customerservice@regalboats.com](mailto:customerservice@regalboats.com).

Please read the warranty carefully. It contains important information on Regal's claims procedures and your rights and obligations under this warranty.

**WHAT IS COVERED:** This Limited Warranty applies only to Regal boats beginning with model year 2017.

**LIFETIME LIMITED STRUCTURAL DECK & HULL WARRANTY:** Regal Marine Industries, Inc. warrants to the original retail purchaser of this boat if purchased from an authorized Regal dealer that the selling dealer or Regal will repair or replace the factory installed fiberglass if it is found to be structurally defective in material or workmanship for as long as the original retail purchaser owns the boat. For purposes of this Limited Warranty, the hull is defined as the single fiberglass casting which rests on the water. This Limited Warranty is subject to all limitations and conditions explained below.

**FIVE-YEAR TRANSFERABLE LIMITED STRUCTURAL HULL WARRANTY:** In addition to the Lifetime Limited Structural Hull Warranty, Regal offers a Transferable Five-Year Limited Structural Hull Warranty. Under the Five-Year Transferable Limited Structural Hull Warranty, Regal will repair or replace the fiberglass hull or deck if it is found to be structurally defective in material or workmanship within the first (5) years after the date of delivery to the original retail purchaser. Any remaining term of this Five-Year Limited Hull Warranty may be transferred to a second owner if within 60 days of purchase, the new owner registers the transfer with Regal and pays the established Limited Warranty transfer fee. Contact Regal Customer Service at the above address for details.

**FIVE-YEAR LIMITED HULL BLISTER WARRANTY:** Regal warrants that the Regal selling dealer or Regal will repair any underwater gelcoated surfaces of the hull against laminate blisters which occur as a result of defects in material or workmanship within (5) years of the date of delivery, provided that the original factory gelcoat surface has not been altered. Alternation would include but is not limited to damage repair; excessive sanding, scraping, sandblasting; or from improper surface preparation for application of a marine barrier coating or bottom paint, any of which shall void this Five-Year Limited Hull Blister Warranty. Proper preparation must be applied to the hull bottom if the boat is to be moored for periods in excess of (60) days. Regal Marine shall repair or cause to be repaired any covered laminate blisters based on the following prorated schedule. Less than three (3) years from delivery date - 100%, Three (3) to (4) years from delivery date - 50%, Four (4) to (5) years from delivery date - 25%.

Reimbursement shall be limited to one repair, not to exceed (\$100.00) dollars per foot of boat length prior to prorating. Regal's prior authorization for the method and cost of repair, must be obtained before repairs are commenced. All costs to transport the boat for repairs are the responsibility of the owner.

**LIMITED GENERAL WARRANTY:** In addition to above hull warranties, Regal warrants to the original purchaser of this boat if purchased from an authorized Regal dealer, that the authorized Regal dealer or Regal will repair or replace any parts found to be defective in materials or workmanship for a period of one (1) year from the date of delivery, subject to all exceptions, limitations and conditions contained herein.

**LIMITED EXTERIOR FINISH WARRANTY:** Regal warrants that the authorized Regal selling dealer or Regal will repair cosmetic defects in the exterior gelcoated finish including cracks, air voids or crazing for one year from the date of delivery, subject to all limitations and conditions contained herein. All warranty work is to be performed at a Regal dealership or other location authorized by a Regal Customer Service Manager after it is established to Regal's satisfaction that there is a defect in material or workmanship.

**CUSTOMER OBLIGATIONS:** The following are conditions precedent to the availability of any benefits under these limited warranties:

(a) The purchaser, who is not Regal's sales agent and is otherwise not in any general or sales agency relationship with Regal, must sign and the authorized Regal selling dealer, must submit to Regal the "NEW BOAT DELIVERY and ACCEPTANCE CHECKLIST" within fifteen (15) days of the date of delivery and such information must be on file at Regal.

(b) The purchaser must first notify the authorized Regal selling dealer from whom the boat was purchased of any claim under this Limited Warranty within the applicable Limited Warranty period and within a reasonable period of time (not to exceed thirty (30) days) after the defect is or should have been discovered.

(c) Regal will not be responsible to repair any condition or replace any part, (1) if the use of the boat is continued after the defect is or should have been discovered; and (2) if such continued use causes other or additional damage to the boat or component parts of the boat.

(d) Based on the authorized Regal selling dealer's knowledge of Regal's Limited Warranty policy and/or consultations with Regal, the dealer will accept the claim and arrange for appropriate repairs to be performed, or deny the claim if it is not within the Limited Warranty policy.

(e) The authorized Regal selling dealer will contact the Regal boat owner regarding instructions for delivery of boat or part for covered warranty repair if it is covered by the Limited Warranty.

**ALL COSTS TO OR FROM THE BOAT AND/OR TRANSPORT OF THE BOAT FOR REPAIRS ARE THE RESPONSIBILITY OF THE OWNER.**

(f) If the Regal boat owner believes a claim has been denied in error or the authorized Regal selling dealer has performed the warranty work in an unsatisfactory manner, the owner must notify Regal's Customer Service Department in writing at the address listed for further consideration. Regal will then review the claim and take appropriate follow-up action.

(g) Before bringing any action, claim, lawsuit, or otherwise seeking relief against Regal based on any alleged breach of any of the Limited Warranties, terms or conditions herein, the Regal Boat owner must contact Regal's Customer Service Department Directly allow Regal, beyond those efforts made by its authorized Regal dealer, notice an opportunity to cure any alleged breach of any of the terms of any of the Limited Warranties.

**WARRANTY EXCEPTIONS:** THIS LIMITED WARRANTY does not cover, the following are not warranted are excluded from the terms of the Regal Limited Warranty and the following terms apply to any Regal Limited Warranty.

- (a) Engines, drives, controls, propellers, batteries, metal plating or finishes, windshield breakage, leakage, fading and deterioration of paints, canvas, vinyl, upholstery and fabrics;
- (b) Gelcoat surfaces including, but not limited to discoloration or blistering except as noted above;
- (c) Accessories and items which were not part of the boat when shipped from the Regal factory, or which carry their own individual warranty and/or any damage caused by such accessories or items;
- (d) Damage caused by one or more of the following: misuse, accident, corrosion, galvanic corrosion, negligence, lack of proper maintenance, or improper trailering;
- (e) Any boat used for racing, or used for rental or commercial purposes;
- (f) Any boat operated contrary to any instructions furnished by Regal, including instructions and guidance provided in the Regal Owner's Manual, or operated in violation of any federal, state, Coast Guard or other governmental agency laws, rules, or regulations;
- (g) The limited warranty is void if alterations have been made to the boat;
- (h) Transportation of boat or parts to and/or from the REGAL factory or service location;
- (i) Travel time or haul outs, loss of time or inconvenience;
- (j) Any published or announced catalog performance characteristics of speed, fuel and oil consumption, and static or dynamic transportation in the water;
- (k) Any boat that has been re-powered beyond Regal's power recommendations;
- (l) Boats damaged by accident and boats damaged while being loaded onto, transported upon or unloaded from trailers, cradles, or other devices used to place boats in water, remove boats from water or store or transport boats on or over land;
- (m) Any item repaired, replaced or modified under the terms of this warranty does not in any way prolong, extend or change any terms set forth in this limited warranty;
- (n) Water damage to, dry rot to, condensation to, or absorption by interior surfaces, wood structures or polyurethane foam; interior wood including, but not limited to mold, bleeding and/or discoloration as a result of condensation or moisture or water continually contacting the plywood causing staining to upholstery, carpet or other interior surfaces;
- (o) Costs or charges derived from inconvenience or loss of use, commercial or monetary loss due to time loss, and any other special, incidental or consequential damage of any kind or nature whatsoever;
- (p) Regal reserves the right to improve the design or manufacture process of Regal boats without obligation to modify previously produced product;

**NO WAIVER OF THESE TERMS:** The terms, conditions, limitations and disclaimers contained herein cannot be waived except by the Customer Service Manager of Regal. Any such waiver must be in writing. Neither the dealer, nor the customer, nor any service, sales and/or warranty representative of Regal is authorized to waive and/or modify these conditions, limitations and/or disclaimers.

**EXCEPT AS SET FORTH HEREIN OR ON ANY OTHER WRITTEN EXPRESS LIMITED WARRANTIES BY REGAL, THERE ARE NO OTHER WARRANTIES EITHER EXPRESSED OR IMPLIED PROVIDED BY REGAL ON THIS BOAT. ALL OTHER WARRANTIES, EXPRESS OR IMPLIED, INCLUDING IMPLIED WARRANTIES OF FITNESS AND MERCHANTABILITY, ARE EXPRESSLY EXCLUDED.** REGAL FURTHER DISCLAIMS ANY LIABILITY FOR ECONOMIC LOSS ARISING FROM CLAIMS OF PRODUCT FAILURE, NEGLIGENCE, DEFECTIVE DESIGN, MANUFACTURING DEFECT, FAILURE TO WARN AND/OR INSTRUCT, LACK OF SEAWORTHINESS, AND ANY OTHER THEORY OF LIABILITY NOT EXPRESSLY COVERED UNDER THE TERMS OF THIS LIMITED WARRANTY.

AS SET FORTH ABOVE, REGAL MAKES NO IMPLIED WARRANTY OF MERCHANTABILITY AND EXPRESSLY EXCLUDES ANY SUCH WARRANTY. TO THE EXTENT SUCH EXCLUSION IS NOT ALLOWED BY LAW OR AN IMPLIED WARRANTY OF MERCHANTABILITY IS ALLOWED BY LAW: (1) ANY IMPLIED WARRANTY OF MERCHANTABILITY THAT IS, AS A MATTER OF LAW, NOT PERMITTED TO BE EXCLUDED AS SET FORTH ABOVE, IS LIMITED TO ONE



YEAR FROM THE DATE OF DELIVERY TO THE FIRST RETAIL OWNER; (2) NEITHER REGAL NOR ANY SELLING DEALER SHALL HAVE ANY RESPONSIBILITY FOR LOSS OR USE OF THE BOAT, LOSS OF TIME, INCONVENIENCE, COMMERCIAL LOSS, INCIDENTAL OR CONSEQUENTIAL DAMAGES. SOME STATES MAY NOT ALLOW EXCLUSIONS OF IMPLIED WARRANTIES OR LIMITATIONS ON HOW LONG ANY IMPLIED WARRANTY LASTS, SO THE ABOVE LIMITATION MAY NOT BE APPLICABLE. SOME STATES MAY NOT ALLOW THE EXCLUSION OR LIMITATION OF INCIDENTAL OR CONSEQUENTIAL DAMAGES, SO THE ABOVE LIMITATIONS OR EXCLUSIONS MAY NOT BE APPLICABLE IN THOSE STATES. THIS WARRANTY GIVES THE OWNER SPECIFIC LEGAL RIGHTS, AND THE OWNER MAY ALSO HAVE OTHER RIGHTS WHICH VARY FROM STATE TO STATE.

THE TERMS AND CONDITIONS CONTAINED HEREIN, AS WELL AS THOSE OF ANY DOCUMENTS PREPARED IN CONJUNCTION WITH THE SALE OF THIS VESSEL MAY NOT BE MODIFIED, ALTERED OR WAIVED BY ANY ACTION, INACTION OR REPRESENTATIONS, WHETHER ORAL OR IN WRITING, EXCEPT UPON THE EXPRESSED, WRITTEN AUTHORITY OF A MANAGEMENT LEVEL EMPLOYEE OF REGAL. Some states do not allow limitations on how long an implied warranty lasts, so the above limitation may not apply to you. Regal's obligation with respect to this warranty is limited to making repairs to or replacing the defective parts and no claim for breach of warranty shall be cause for cancellation or rescission of the contract or sale for any boat manufacturer by REGAL MARINE INDUSTRIES, INC.

Regal will discharge its obligations under this warranty as rapidly as possible, but cannot guarantee any specific completion date due to the different nature of claims which may be made and services which may be required. Regal reserves the right to change or improve the design of its boats without obligation to modify any boat previously manufactured. This limited warranty gives you specific legal rights, and you may also have other rights which may vary from state to state. Regal shall in no way be responsible for any repairs not PRE-AUTHORIZED by a Regal Customer Service Manager or repairs performed by a repair shop not PRE-AUTHORIZED by a Regal Customer Service Manager.

## **ARBITRATION OF DISPUTES AND WAIVER OF JURY TRIAL**

EXCEPT AS SPECIFICALLY EXCLUDED IN THIS LIMITED WARRANTY, PURCHASER, REGAL AND AUTHORIZED REGAL DEALER AGREE TO SUBMIT ANY AND ALL CONTROVERSIES, CLAIMS OR DISPUTES ARISING OUT OF OR RELATING TO THE BOAT AND THIS LIMITED WARRANTY AND ALL OTHER AGREEMENTS EXECUTED BY PURCHASER RELATED TO THE BOAT TO BINDING ARBITRATION. IT IS THE EXPRESS INTENT OF PURCHASER, REGAL AND DEALER THAT THIS ARBITRATION PROVISION APPLIES TO ALL DISPUTES, INCLUDING CONTRACT DISPUTES, TORT CLAIMS, FRAUD CLAIMS AND FRAUD-IN-THE INDUCEMENT CLAIMS, STATUTORY CLAIMS AND REGULATORY CLAIMS RELATING IN ANY MANNER TO THE BOAT AND THIS LIMITED WARRANTY.

IF ANY CONTROVERSY OR CLAIM DESCRIBED IN THIS ARBITRATION PROVISION IS DETERMINED FOR ANY REASON TO BE INELIGIBLE FOR ARBITRATION, AND FOR ANY CONTROVERSIES, CLAIMS, OR DISPUTES SPECIFICALLY EXEMPTED FROM ARBITRATION, THEN THOSE CONTROVERSIES, CLAIMS, OR DISPUTES SHALL INSTEAD BE DECIDED BY A JUDGE OF A COURT OF COMPETENT JURISDICTION, IN ORANGE COUNTY, FLORIDA, WITHOUT A JURY. PURCHASER, REGAL AND DEALER KNOWINGLY AND VOLUNTARILY WAIVE THE RIGHT TO A TRIAL BY JURY FOR ALL SUCH CONTROVERSIES, CLAIMS AND DISPUTES. PURCHASER, REGAL, AND DEALER UNDERSTAND THAT THERE SHALL BE NO JURY TRIAL, WHETHER THE CONTROVERSY OR CLAIM IS DECIDED BY ARBITRATION OR BY TRIAL BEFORE A JUDGE. NOTWITHSTANDING THE PROVISIONS OF THIS ARBITRATION AGREEMENT, WITH REGARD TO CONTROVERSIES AND/OR ENTITLEMENT TO POSSESSION OF EITHER THE BOAT OR ANY TRADE-IN, ANY PARTY HERETO MAY RESORT TO A JUDICIAL DETERMINATION (BY A JUDGE AND NOT A JURY). OF SUCH CONTROVERSIES, DISPUTES OR CLAIMS WITHOUT WAIVING ANY RIGHT TO DEMAND ARBITRATION WITH RESPECT TO ALL OTHER CONTROVERSIES, DISPUTES OR CLAIMS BETWEEN THE PARTIES A MORE SPECIFICALLY SET FORTH IN THIS ARBITRATION PROVISION.

ALL ARBITRATIONS SHALL PROCEED THROUGH THE AMERICAN ARBITRATION ASSOCIATION AND BE SUBJECT TO ITS COMMERCIAL ARBITRATION RULES, EXCEPT AS SET FORTH HEREIN. THE ARBITRATORS SHALL HAVE THE AUTHORITY TO AWARD ANY FORM OF RELIEF THAT COULD BE PROPERLY AWARDED IN A CIVIL ACTION IN THE STATE OF FLORIDA FOR THE TYPE OF CLAIMS PRESENTED, SUBJECT HOWEVER, TO ALL LIMITATIONS, PREDICATES, AND CONDITIONS COVERING SUCH REMEDIES OR RELIEF UNDER FLORIDA LAW.

THE PURCHASER, REGAL OR DEALER MAY DEMAND ARBITRATION OF A CLAIM BY FILING A WRITTEN DEMAND FOR ARBITRATION, ALONG WITH A STATEMENT OF THE MATTER IN CONTROVERSY WITH THE AMERICAN ARBITRATION ASSOCIATION, AND SIMULTANEOUSLY SERVING A COPY UPON THE OTHER PARTY. PURCHASER, REGAL AND DEALER AGREE THAT THE ARBITRATION PROCEEDING SHALL BE CONDUCTED IN ORANGE COUNTY, FLORIDA UNLESS OTHERWISE AGREED BY THE PARTIES. EACH PARTY AGREES TO BEAR THEIR OWN ATTORNEY FEES AND COSTS. THE FILING FEES AND ALL OTHER THIRD-PARTY COSTS FOR THE ARBITRATION, INCLUDING THE ARBITRATOR'S FEE SHALL BE PAID BY THE FILING PARTY INITIATING THE ARBITRATION. THE PREVAILING PARTY SHALL BE ENTITLED TO REIMBURSEMENT OF THEIR REASONABLE ATTORNEY FEES AND REASONABLE EXPENSES FROM THE NON-PREVAILING PARTY.

## **REGISTRATION INFORMATION:**

# Chapter 2

## Safety On Board



Safety awareness can not be over emphasized. Safety on board needs to be the skippers number one priority.

In this manual you will find many safety precautions and symbols to identify safety related items. Heed all safety precaution information. Remember, the skipper is responsible for the safety of his passengers.

### Safety Labels

#### Safety Precaution Definition:

Safety precautions are stated as caution, warning and danger signal words. They are highlighted in this manual by font design and symbol usage. Also, a notice heading is included which provides operation and maintenance information but is not hazard-related. An information label provides tips on a variety of topics.

Read and understand all safety labels affixed to your Regal boat or found in this manual and the vendor literature. Many of the safety labels are posted close to the helm, aft cockpit, cabin and swim platform. The location of the labels may vary. Review the helm safety labels with passengers before disembarking. Use common sense to analyze the result of an action on board your vessel. Always think safety first!

## NOTICE

DO NOT REMOVE OR COVER ANY PRECAUTIONARY LABELS. KEEP HARSH CHEMICALS AWAY FROM LABELS. IF A LABEL BECOMES ILLEGIBLE, CONTACT YOUR REGAL DEALER FOR ORDERING REPLACEMENTS.

## NOTICE

General or specific information which is important to correct operation or maintenance, but is not hazard related.



## CAUTION

Indicates a potentially hazardous situation or unsafe practice that, if not avoided, may result in injury, property or product damage.



## WARNING

Potentially hazardous situation that, if not avoided, could result in death or serious injury.



## DANGER

Immediate hazardous situation that if not avoided, will result in death or serious injury.

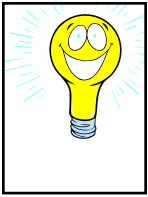

Note that throughout this manual in select locations are inserted hints and tips to component operation and safety information. Use these hints and tips to enhance your nautical knowledge of on board components and operations.

## General Boating Safety

We understand that you are eager to go boating. However, we strongly suggest that you thoroughly familiarize yourself and friends or members of your family with safe boating practices before setting out. Remember, that along with the freedom and exhilaration of boating comes the responsibility that you have for the safety of your passengers and other boaters who share the water with you.

Boating regulations vary from state to state. Check with your local and state authorities for the regulations pertaining to your area.

Check with local FM weather stations, U. S. Coast Guard, or on-line for the latest weather conditions.

Remember getting caught in severe weather is hazardous. Check weather conditions periodically while you are boating. If you are forced to operate your boat in a storm condition, take common sense precautions; wear PFD's, store gear, reduce speed and if possible head for safe refuge.

It is best to avoid operating your boat in foggy weather. When fog sets in, take bearings, log courses and speeds. You are required to emit a five second blast from your horn or whistle once every minute. Also, have your passengers wear PFD's and observe for oncoming vessels.

Operation in shallow water presents a number of hazards including sand bars and water levels influenced by tides. If the vessel strikes an underwater hazard, check for boat and engine damage. If the engine vibrates excessively after striking an underwater obstruction, it may indicate a damaged propeller. If you run aground, seek help by radio or flares.

Make sure your boat and equipment are in top condition. Do this by frequently inspecting the hull, engine and propulsion components.

You must provide a Coast Guard approved personal flotation device (PFD) for every person on board. These PFD's should be in good condition and easily accessible.

Insist that non-swimmers and children on board wear a PFD at all times. If you encounter rough weather conditions, make sure everyone on board is wearing a PFD, including yourself. Instruct your passengers in how to put on their PFDs and be sure they know their storage location on the boat. Remember, in an emergency, a PFD that cannot be quickly located and worn is useless.

Never allow anyone to sit anywhere on the boat not specifically designed as seating. **While underway, ALWAYS insist passengers occupy a recognized seat as shown in the technical section of this manual.**

Never drink and drive! As captain, you are responsible for the safety of your passengers. Alcohol and boating can be a dangerous combination. **DO NOT**



mix them. Alcohol impairs the boat operators ability to make conscious decisions and react to emergency situations quickly.

Never overload your boat! An overloaded boat, or one with uneven weight distribution can be difficult to steer. **Never let people stand in bow area while underway as vision will be obstructed!!!**

Insist that passengers wear life jackets and sit in the designated seats per the seating arrangement plan in the technical section of this manual while the vessel is underway!

 **CAUTION**

READ AND UNDERSTAND THE SEATING ARRANGEMENT DRAWING IN THE TECHNICAL CHAPTER. THIS DRAWING DISPLAYS THE DESIGNATED SEATING ARRANGEMENT FOR A BALANCED LOAD AND VESSEL MAXIMUM PERSONS CAPACITY.

Use maximum caution when fueling. Never allow any smoke or flame nearby while you are fueling. Be certain there is enough fuel aboard for your cruising needs especially if your cruise distance expands.

Practice the “one-third rule: Use one-third of your fuel going out, one-third to return and retain one-third as a reserve.

Always check the weather before departure. Be particularly cautious of forecasted electrical storms and high winds.

Always have up-to-date charts aboard as a back-up to your plotter and auto pilot option. Charts can be obtained at your closet marina, on-line store or by contacting one of three federal government agencies.

Always file a float plan. Leave details of your trip with someone responsible who will be remaining on shore. Include expected return, plus name and phone number of a contact person in case of emergency.

Use care, courtesy and common sense when launching, docking or operating your boat.

Learn and obey the “Rules of the Road”. A weather resistant placard copy of the “Rules of the Road” is included in the on board Regal information packet. Additional information can be obtained from the U.S. Coast Guard Auxiliary or your local Power Squadron organization.

In case of emergency know the international distress signals for your VHF radio. The spoken word “MAYDAY” is the international signal of distress and is for emergency use only. Under no circumstances should this word be used, unless there is danger at hand.

Operation in shallow water presents a number of hazards including sand bars and water levels influenced by tides. If the vessel strikes an underwater hazard, check for boat and engine damage. If the engine vibrates excessively after striking an underwater obstruction, it may indicate a damaged propeller. If you run aground, seek help by radio or flares.

Make sure your boat and equipment are in top condition. Do this by frequently inspecting the hull, engine and propulsion components.

You must provide a Coast Guard approved personal flotation device (PFD) for every person on board. These PFD's should be in good condition and easily accessible.

Again, insist that non-swimmers and children on board wear a PFD at all times. If you encounter rough weather conditions, make sure everyone on board is wearing a PFD, including yourself. Instruct your passengers in how to put on their PFDs and be sure they know their storage location on the boat. Remember, in an emergency, a PFD that cannot be quickly located and worn is useless.

Never allow anyone to sit anywhere on the boat not specifically designed as seating. While underway, **ALWAYS** insist passengers sit in a seat and set an example by doing this yourself.

As the captain insist that the transom door be closed and latched while the vessel is underway!

Never drink and drive! As captain, you are responsible for the safety of your passengers. Alcohol and boating can be a dangerous combination. **DO NOT** mix them. Alcohol impairs the boat operators ability to make conscious decisions and react to emergency situations quickly.

Never overload your boat! An overloaded boat, or one with uneven weight distribution can be difficult to steer.

**Insist that passengers sit in seats while the vessel is making headway!! See technical chapter for seating positions while underway. No one to be standing in the bow area while underway as visibility will be obstructed!!!**

Posted speed limits, swimming areas, "no wake" zones and other restrictions should be red-flagged. They are so noted for a reason. Sensible boat use, plus courtesy, equals enjoyable and safe boating.

It is your responsibility to stay abreast of all federal, state and local rules, as some laws or regulations may change or be different from state to state. Contact your local boating agencies for updated information.

We can not stress safety enough! Remember, there are no brakes on your boat, and the water current and wind velocity both affect your ability to respond.



Safety on board deck is a must do item for the boat operator. Always use common sense when boarding and exiting, making headway and anchoring in open waters.

Following are recommendations when using components such as the boarding platform and ladder, foredeck and hand holds.

### Aft Platform

On all types of aft platforms you should make periodic inspections of the hardware that support the platform to ensure that all connections and fittings are tight and in good condition.

Use caution when operating the boat in reverse to insure that water does not accumulate excessively on the platform or transom, especially in rough seas or strong currents. If installed, do not exceed the recommended maximum platform capacity label! Typical label for reference only. (Maximum Capacity varies by platform type & vessel model. Always check your label poundage and do not exceed it!



*Read and understand the warning label above regarding "teak surfing."*



TYPICAL OUTBOARD AFT PLATFORM

### Boarding Ladder

When exiting using the ladder ensure it is fully extended and your feet are firmly planted on each rung. When entering the vessel using the ladder check that the ladder is fully extended and the ladder cover is latched to safely use the hand hold integrated into the cover. Never use any segment of the outboard motor to assist in boarding! Body parts could be injured by the propeller blades. Always ensure the boarding ladder is fully folded and the cover is latched before making headway!



TYPICAL BOARDING LADDER



## Required Safety Equipment

### Personal Flotation Devices:

All personal flotation devices (PFD's) must be Coast Guard approved, in good working condition, and must be the correct size for the wearer. All PFD's must be readily accessible. This means being able to wear them in a reasonable amount of time in case of an emergency (fire, boat sinking, etc.). They should not be stored or locked in closed areas. Also, make sure that all coverings are removed such as plastic from any PFD's. Throw-able devices such as a ring buoy need to be available for immediate deployment. A PFD should be worn at all times when your boat is operating on the water. A PFD may save your life, but it must be worn to do so.

As a minimum U. S. Coast Guard requirement all recreational boats must carry one type I, II, III, or V PFD (wearable) for each person aboard. See the explanation following for each type. For type V to be counted they must be used according to the label instructions. In addition, all boats over 16' must carry one Type IV (throw-able) PFD.

Some states require that PFD's be worn by children of specific ages at all times. Check with local and state boating agencies for particular requirements in your state before taking children on the water. Child life jackets are classified by the child's weight and should like all life jackets be sized before being purchased.

Remember PFD's will not necessarily keep you from drowning, even though they are designed to keep a person from sinking. When purchasing

PFD's make sure it safely fits the person wearing it. It is a good idea to test PFD's in a life guarded shallow pool before venturing on the water.

Refer to the USCG minimum equipment requirements at the end of this chapter. It is meant to be a guide only. Contact state and local agencies for additional equipment requirements. Remember as the captain of your vessel you are responsible for its safe operation.



**Type I:**

Also known as an off-shore jacket, it provides the most buoyancy. It is a PFD for all waters and is especially useful in rough waters where rescue may encompass additional time. It is designed to turn most unconscious users in the water to a true face-up position. Type I PFD is available in adult & child sizes Buoyancy minimum poundages are 15.5 adult, 11 medium child, and 7 for small child and infants.

**Type II:**

Also known as near-shore buoyant vest, it is recommended for calm, inland water where rescue time will be minimal. It will turn some unconscious people face-up in the water but not as numerous as Type I. They are available in adult, medium child, along with infant and small child sizes.

**Type III:**

Known as a flotation aid it is good for calm, inland water or where there is a chance for quick rescue. It is designed so wearers can place themselves in a face-up position in the water. The wearer may have to tilt their head back to avoid face-down positions. Type III offer the same buoyancy minimum poundages as the Type II. They are generally the most comfortable for continuous wear. Float coats, fishing vests, and vests featuring designs for various sport activities are examples of Type III.

**Type IV:**

Intended for calm, inland water with heavy vessel traffic, where help is constantly present. It is designed to be thrown into the water for someone to grab on to and held until rescued. It is not designed to be worn. Type IV includes ring buoys, buoyant cushions, and horseshoe buoys.

**Type V:**

Also known as a special use device this is the least bulky of all PFD's. It contains a small amount of inherent buoyancy, and an inflatable chamber. It is rated even to a Type I, II, or III PFD (as noted on the jacket label) when inflated. Some Type V devices provide significant hypothermia protection. Varieties include deck suits, work vests, board sailing vests and Hybrid PFD's. Remember that this Type V type PFD may be carried instead of another PFD only if used according to the approval condition on the label.

Note: A water skier or wake boarder is considered on board the vessel and a PFD is required for the purposes of compliance with the PFD carriage requirements. It is advisable and recommended for a skier or wake boarder to wear a PFD designed to withstand the impact of hitting the water at a high speed. "Impact Class" marking on the label refers to PDF strength, not personal protection. Some state laws require a skier or wake boarder to wear a PFD.

## PFD's For Pets:



If you are a skipper who needs to have his pet dog or cat on board or dock side then a PFD is recommended. The PFD will aid you in finding the pet if it should fall overboard. The device must fit the pet properly. Also, it may take a bit of training before the pet is comfortable wearing the PFD. Normally, dogs are easier to train wearing a life vest than a cat. Marine type retail stores will fit a pet to a PFD by body weight.

## Maintaining Your PFD's

A PFD is only useful if it is well maintained. Always be aware of PFD age since it has a life expectancy like any other piece of equipment.

- ✓ Check periodically for broken zippers, frayed webbing, water soaked kapok bags, missing straps, and sewing that has become undone.
- ✓ Clean each PFD with mild soap and water only. Again, let dry sufficiently before storing.
- ✓ Keep PFD's out of grease and oil since they can deteriorate the jacket inner and outer materials.
- ✓ Check any kapok-bagged jackets by squeezing. If you hear air escaping the bag is defective and the PFD should be thrown away.
- ✓ Grab the cover with the fingers. If the cover material rips, the PFD is rotted and should be thrown away.

## Fire Extinguishers

### General Information:

Fire extinguishers are classified by a letter and numeric symbol. The letter references the type of fire the unit is designed to extinguish.

For example, type B extinguishers commonly used on boats are designed to put out flammable liquids such as grease, oil and gasoline.

The number indicates the general size of the extinguisher (minimum extinguishing agent weight).

Coast Guard Approved extinguishers are identified by the following marking on the label:

*"Marine Type USCG Approved, Size..., Type..., 162.028/.../", etc.*

MINIMUM PORTABLE FIRE EXTINGUISHERS REQUIRED		
VESSEL LENGTH	NO FIXED SYSTEM	WITH FIXED SYSTEM
LESS THAN 26'	1 B-I	0
26' TO LESS THAN 40'	2 B-I or 1 B-II	1 B-I
40' TO 65'	3 B-I or 1 B-I & 1 B-II	2 B-I or 1 B-II

### FIRE EXTINGUISHER CONTENTS

CLASS	FOAM IN GALS.	CO2 IN LBS.	DRY CHEM IN LBS.	HALON IN LBS.
B-I	1.75	4	2	2.5
B-II	2.5	15	10	10

U. S. Coast Guard approved fire extinguishers are required on all Regal boats as they are engine propelled and feature permanently fuel systems. Besides the minimum Coast Guard requirements always check state and local agencies for additional requirements and equipment.

Coast Guard approved extinguishers are hand-portable, either B-I or B-II classification. U. S. Coast Guard approved hand-portable and semi-portable extinguishers contain a metal plate that shows the manufacturers name and extinguisher type, capacity and operating instructions. They have a special marine type mounting bracket which keeps the extinguisher solidly mounted until needed. The extinguisher needs to be mounted in a readily accessible location but one that will not be bumped by people while underway. All approved extinguishers shall have an indication gauge.

### U.S.C.G Approved Fire Extinguisher Types & Features:

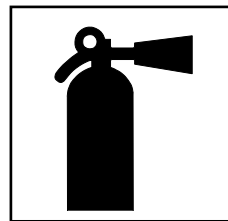

The dry chemical agent is widely used because of its convenience and low cost. The extinguisher canister is filled with a white dry chemical powder along with a pressurized gas. It is a good idea to shake this type periodically because they tend to "pack" on the canister bottom.

The foam type uses a chemical foaming agent plus



water and is best when used for fires involving flammable liquids- solvents, gasoline, oil, grease and various paints. It will work on fires involving

rubber, plastics, cloth, wood, and paper. It leaves a messy residue. Do not use this extinguisher for electric fires.



The carbon dioxide unit uses CO<sub>2</sub> gas under high pressure, with a funnel discharge hose usually swivel mounted. This extinguisher leaves no

residue and does not cause interior engine harm. To ensure workability, weigh the unit annually. A 10% maximum weight variance is allowed.

Another type of liquefied gas used today is FE-241. This gas is colorless and odorless, heavier than air and sinks to the lower bilge to extinguish fires. Since the year 2000 ingredients have changed to a more environmental friendly formula (Chlorotetrafluoroethane or FE-241). FE-241 is used in portable-hand units along with making up the majority of boat automatic fire extinguishing systems. The canister needs to be weighed once a year. These clean agent units feature a dash mount indicator. Refer to the information regarding fire prevention in this manual.

## Pyrotechnic Devices:

Pyrotechnic visual distress signals must be Coast Guard approved, be ready for service and must be readily accessible. They all display a marking which is the service life, which must not have expired. A minimum of 3 devices are required for the day and 3 devices for night.

Some devices meet both day and night requirements. Pyrotechnic devices should be stored in a cool, dry location. Most of these devices can be purchased in an highly visible (orange) watertight container. Types of Coast Guard approved pyrotechnic distress signals and associated devices are:

- Pyrotechnic red flares, hand-held or aerial type.
- Pyrotechnic orange smoke, hand-held or floating type.
- Launchers for parachute flares or aerial red meteors.

All in all, each distress signal has certain advantages and disadvantages.

There is no distress signal that is best under all situations. Pyrotechnics are recognized worldwide as superior distress signals. A downfall is they emit a very hot flame that can cause burns and or ignite flammable materials. Pistol launched and hand-held parachute flares operate consistent with firearms and therefore must be carefully handled. Check with local and state regulations since some of these device are considered firearms and are prohibited.

It is best to carry red aerial flares which are visible from a greater distance. Also, the red parachute flares burn for longer periods and therefore are more likely to be seen by another vessel.

## Non-Pyrotechnic Devices:

Non-pyrotechnic devices must all be in serviceable condition, readily accessible, and must be certified by the manufacturer to comply with the U. S .C. G standards. They include:

- Orange distress flag (Day Only).
- Electric distress light (Night Only).

The distress flag is for day use only. It must be 3 x 3 or larger with a black square and ball on an orange background. It can be spotted when attached to a boat hook, long fishing rod, or paddle with the person waving the flag back and forth overhead.

The electric distress light is for night use only flashing the international SOS distress signal (... \_ \_ \_ ...).

Under Inland Navigation Rules, a high intensity white light that flashes at regular intervals from 50-70 times per minute is considered a distress signal.

Remember that regulations prohibit the display of visual distress signals on the water under any circumstances except when assistance is required to prevent immediate or potential danger to passengers on a vessel.



## International Distress Signals

A distress signal, also known as a distress call, is an internationally recognized means for obtaining help. Distress signals are communicated by transmitting radio signals, displaying a visually observable item or illumination, or making a sound audible from a distance.

### Use of Mayday

A Mayday message consists of the word "mayday" spoken 3 times in succession, which is the distress signal, followed by the distress message, which should include:

1. Name of the vessel or ship in distress.
2. Her position (actual, last known or estimated expressed in lat/long. or distance/bearing from a specific location).
3. Nature of the vessel distress condition or situation (e.g. on fire, sinking, aground, taking on water, adrift in hazardous waters).
4. Number of persons at risk or to be rescued, grave injuries.
5. Type of assistance needed or being sought.
6. Any other details to facilitate resolution of the emergency such as actions being taken (e.g. abandoning ship, pumping flood water) est. time afloat.

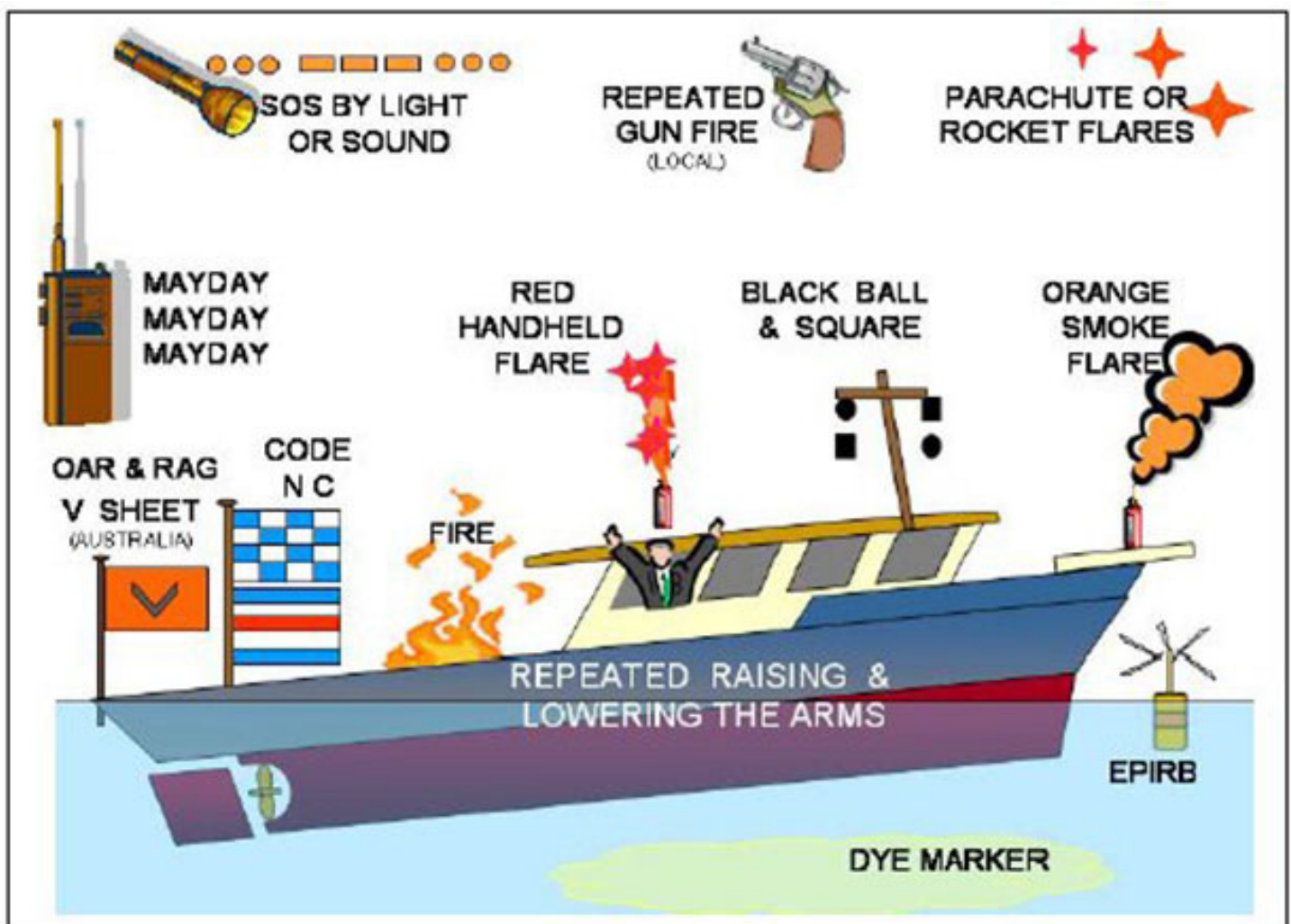



## Sound Producing Devices

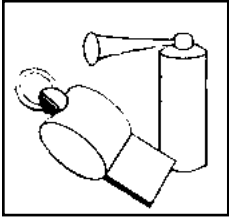

According to both Inland and International Rules, all boats must carry a way of producing an efficient sound signal. If your vessel is 12 meters (39.

4 ft.) or longer, a power whistle or power horn must be carried. Currently, a bell must be carried on vessels 20 meters (65.6 ft) or longer. The sound signal made in all cases must be capable of a four or six second blast audible for one half mile. See the section discussing bridge and whistle signals for more information.

### Radio Communications:

VHF radios are used for distress and ship to shore and ship to ship communications today. Learn the specialized messages such as Mayday, Mayday, Mayday. It is only used when life or vessel is in imminent danger.



Many of the more recent VHF's feature DSC ca-

pability which offers the ability to place and receive digital calls directly with vessels and shore stations including USA and Canadian Coast Guards. Channel 70 is reserved exclusively for DSC calls. Refer to the VHF owner's information since you need to establish a Mobile Maritime Safety Identity (MMSI) number before using the DSC feature. A MMSI number identifies each DSC radio, like a telephone number. The FCC requires a ship station license for all vessels equipped with a marine VHF radio.

### Navigation Lights:

The U. S. Coast Guard requires recreational boats operating at night to display navigation lights between sunset and sunrise along with other periods of reduced visibility.

Navigation lights help avoid collisions by improving the night visibility of vessels. Red and green directional lights, white stern lights, white masthead lights and white all-around lights must be displayed in specified positions, depending on boat size, and mode of operation.

### Marine Sanitation Devices:

Recreational vessels under 65' with installed toilet facilities must have an operable marine sanitation device (MSD) on board. Vessels 65' and under may use Type I, II, or III MSD's. All installed MSD's must be U.S. Coast Guard certified. The MSD's are labeled to show conformity to the regulations.

### Navigation Rules:

The navigation rules establish actions to be taken by vessels to avoid collision. They are divided into Inland/International. Operators of vessels 39.4' or more shall have on board and maintain a copy of the Inland navigation rules.

# Navigation Light Rules

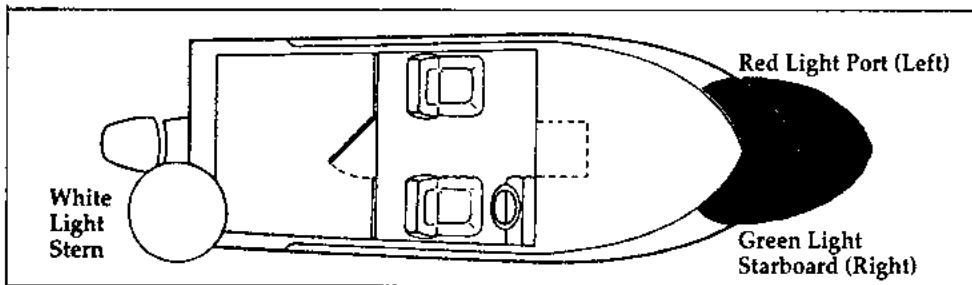

Location of lights on vessel	Visible Range		Degrees of arc lights
	Less than 12 m.	12 m. but less than 20 m.	
Masthead	2	3	225°
All-round	2	2	360°
Side lights	1	2	112.5° each color
Stern light	2	2	135°

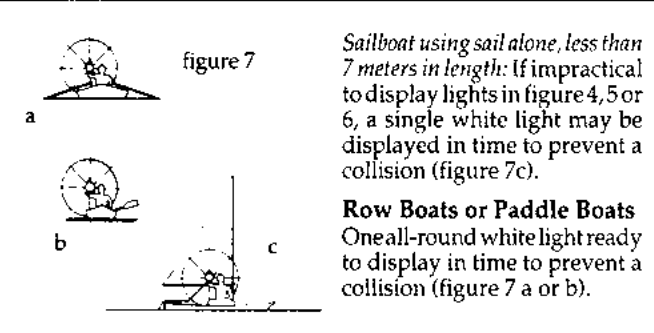
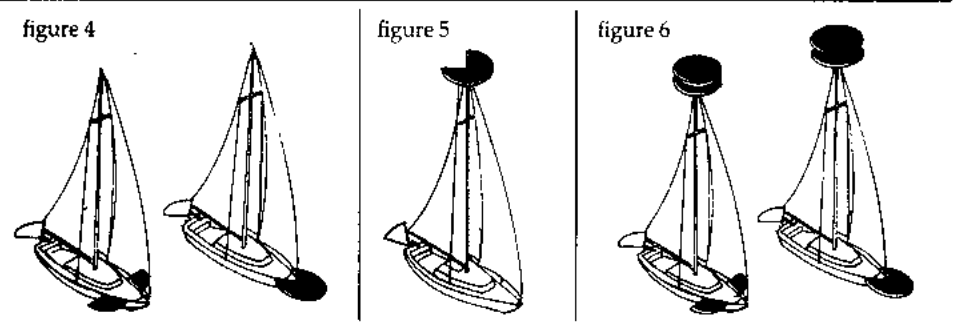
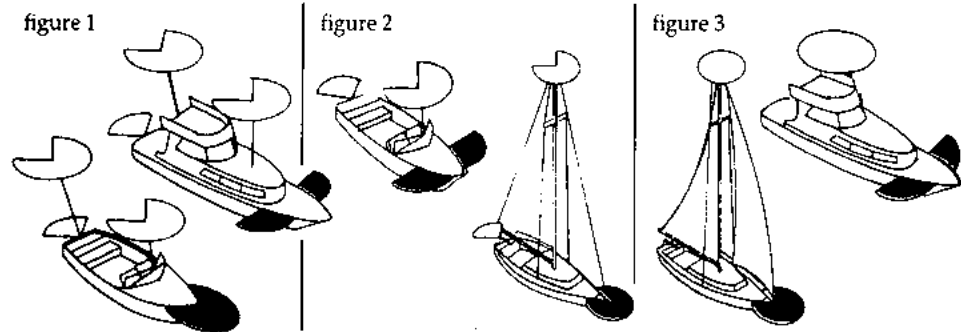

*Sailboat using sail alone, less than 7 meters in length: If impractical to display lights in figure 4, 5 or 6, a single white light may be displayed in time to prevent a collision (figure 7c).*

**Row Boats or Paddle Boats**  
One all-round white light ready to display in time to prevent a collision (figure 7 a or b).

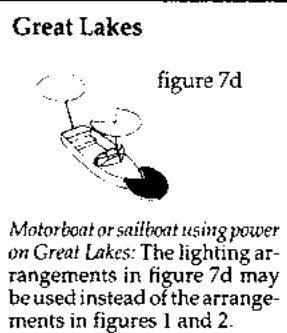

*Motorboat or sailboat using power on Great Lakes: The lighting arrangements in figure 7d may be used instead of the arrangements in figures 1 and 2.*

**Boats less than 12 meters in length**  
*Motorboats or sailboats using power:* The lighting arrangements to figure 1, 2 or 3 may be used.

*Sailboat using sails alone:* The lighting arrangements in figure 4, 5 or 6 may be used.

**Boats 12 meters but less than 20 meters in length**

*Motorboats or sailboats using power:* The lighting arrangements to figure 1 or 2 may be used.

*Sailboat using sails alone:* The lighting arrangements in figure 4, 5 or 6 may be used.

**Location of lights**

Lights should be located as shown in the drawings.

The masthead light (forward white light in figures 1, 2 and 7d) must be at least one meter higher than the colored lights on a boat less than 12 meters in length and at least 2.5 meters above the gunwale on a boat 12 meters but less than 20 meters in length.

**Exceptions**

*Motorboat or sailboat using power, built before December 24, 1980:* The lighting arrangement in figure 1, 2 or 3 may be used. However, the arrangement in figure 3 is not acceptable on a boat that is 12 meters or longer on international waters.

### DISCHARGE OF OIL PROHIBITED

THE FEDERAL WATER POLLUTION CONTROL ACT PROHIBITS THE DISCHARGE OF OIL OR OILY WASTE INTO OR UPON THE NAVIGABLE WATERS OF THE UNITED STATES, OR THE WATERS OF THE CONTIGUOUS ZONE, OR WHICH MAY AFFECT NATURAL RESOURCES BELONGING TO, APPERTAINING TO, OR UNDER THE EXCLUSIVE MANAGEMENT AUTHORITY OF THE UNITED STATES, IF SUCH DISCHARGE CAUSES A FILM OR DISCOLORATION OF THE SURFACE OF THE WATER OR CAUSES A SLUDGE OR EMULSION BENEATH THE SURFACE OF THE WATER. VIOLATORS ARE SUBJECT TO SUBSTANTIAL CIVIL PENALTIES AND/OR CRIMINAL SANCTIONS INCLUDING FINES AND IMPRISONMENT.

#### **Marpol Treaty:**

The USCG now enforces the International Convention for the Prevention of Pollution from ships, referred to commonly as the MARPOL TREATY (marine pollution). This international treaty prohibits the overboard dumping of all oil, garbage, ship-generated plastic and chemicals. There is a placard on board your boat (typical example shown below) that explains the garbage and plastic dumping laws in detail.

Immediately notify the USCG if your vessel discharges oil or hazardous substances in the water. Call toll free 1-800-424-8802. Report the following information: location, source, size, color, substances and time observed.

No vessel may intentionally drain oil or oily waste from any source into the bilge of any vessel. A

bucket or bailer is suitable as a portable means of discharging oily waste.

The placard noted above is normally located in the engine compartment or may be attached to the engine hatch.



## Garbage Discharge

THE DISCHARGE OF PLASTIC OR GARBAGE WITH PLASTIC INTO ANY WATERS IS PROHIBITED. THE DISCHARGE OF ALL GARBAGE IS PROHIBITED IN THE NAVIGABLE WATERS OF THE UNITED STATES AND IN ALL OTHER WATERS, WITHIN THREE NAUTICAL MILES OF THE NEAREST LAND.

THE DISCHARGE OF DUNNAGE, LINING, AND PACKING MATERIALS THAT FLOAT IS PROHIBITED WITHIN 25 NAUTICAL MILES FROM THE NEAREST LAND.

OTHER UNGROUND GARBAGE MAY BE DISCHARGED BEYOND 12 NAUTICAL MILES FROM THE NEAREST LAND.

OTHER GARBAGE GROUND TO LESS THAN ONE INCH MAY BE DISCHARGED BEYOND THREE NAUTICAL MILES FROM THE NEAREST LAND.

A PERSON WHO VIOLATES THE ABOVE REQUIREMENTS IS LIABLE FOR A CIVIL PENALTY OF UP TO \$25,000, A FINE OF UP TO \$50,000, AND IMPRISONMENT FOR UP TO FIVE YEARS FOR EACH VIOLATION, REGIONAL, STATE, AND LOCAL RESTRICTIONS ON GARBAGE DISCHARGES MAY ALSO APPLY.

The act to prevent pollution from ships places limitations on the discharge of garbage from vessels. It is illegal to dump plastic trash anywhere in the ocean or navigable waters of the United States. Also, it is illegal to discharge garbage in the navigable waters of the United States, including the Great Lakes. The discharge of other types of garbage is allowed outside certain specified distances from shore as determined by the nature of that garbage.

United States vessels of 26 feet or longer must display in a prominent location, a durable placard at least 4" x 9" notifying crew and passengers of discharge restrictions.

USA vessels of 26' or longer equipped with a galley and berthing must have a written Management Plan describing steps for collecting, processing, storing and discharging garbage, and designate the person charged with carrying out the plan. The placard noted is usually found near a galley or inside the engine hatch area.

## Life Rafts



Inflatable life rafts are recommended for ocean going and vessels operating in a large body of water like the Great Lakes. They provide a shelter for extended periods. If used, make sure it is large enough for all aboard and contains the proper emergency equipment pack. Also, periodically have the unit professionally serviced. Make sure the life raft is Coast Guard approved since it would require meeting a number of stringent material and performance standards.



## USCG Minimum Equipment Requirements

Use the chart below as a guideline for assuring your vessel is outfitted to meet USCG standards. Remember to check with local and state authorities for additional equipment requirements. Make sure your vessel certificate of numbers are on the boat, updated and displayed properly according to state requirements. Keep the paperwork on board in a watertight and safe environment.

On documented vessels keep both the original and current certificate on board stored in a safe, dry, and accessible location. Also, on documented vessels make sure the vessel name/hailing port are marked on the hull exterior with letters not less than 4" in height. In addition, the Official Number must be permanently affixed on a clearly visible interior structure part of the boat-block type Arabic numbers not less than 3" in height.

		QUICK REFERENCE CHART			
Equipment	Requirement	Vessel Length (in feet)			
		<16	16-26	26-40	40-65
<b>Certificate of Number (State Registration)</b>	All undocumented vessels equipped with propulsion machinery must be state registered. Certificate of Number must be on board when the vessel is in use. Note that some states require all vessels to be registered.	X	X	X	X
<b>State Numbering</b>	(a) Plain block letters/numbers, not less than 3 inches in height, must be affixed on each side of the forward half of the vessel, in a contrasting color to the background, and read from left to right. (b) State validation sticker(s) must be affixed within 6 inches of the registration number. Note: check with your local boating agency for specific state requirements.	X	X	X	X
<b>Certificate of Documentation</b>	Applies only to "Documented" vessels: (a) Original and current certificate must be on board. (b) Vessel name/hailing port must be marked on exterior part of hull in letters not less than 4 inches in height. (c) Official Number must be permanently affixed on interior structure in numbers not less than 3 inches in height.		X	X	X
<b>Life Jackets</b>	(a) One Type I, II, III, or V wearable life jacket for each person on board. Must be U.S. Coast Guard-approved. (b) In addition, must carry one Type IV throwable device.	X	X	X	X
<b>Visual Distress Signals (VDS)</b>	(a) One electric distress light, or three combination day/night red flares. Note: only required to be carried on board when the vessel is operating between sunset and sunrise. (b) Three combination day/night red flares – hand-held, meteor, or parachute-type, or one orange distress flag, or one electric distress light, or three hand-held or floating orange smoke signals and one electric distress light.	X	X	X	X
<b>Fire Extinguishers</b>	(a) One B-I (when enclosed compartment). (b) One B-II or two B-I. Note: fixed system equals one B-I. (c) One B-II and one B-I, or three B-I. Note: fixed system equals one B-I.	X	X	X	X
<b>Ventilation</b>	(a) All vessels built after April 25, 1940 that are gasoline-fueled with enclosed engine and/or fuel tank compartments must have natural ventilation (at least two ducts fitted with cowls). (b) In addition, a vessel built after July 31, 1980 must have a rated power exhaust blower.	X	X	X	X
<b>Sound Producing Devices</b>	(a) A vessel of less than 39.4 feet (12 meters) must, at a minimum, have some means of making an efficient sound signal – i.e., handheld air horn, athletic whistle. A human voice/sound is not acceptable. (b) A vessel 39.4 feet (12 meters) or greater, must have a sound-signaling appliance capable of producing an efficient sound signal, audible for 1/2 mile, with a 4- to 6-second duration.	X	X	X	X
<b>Backfire Flame Arrestor</b>	Required on gasoline engines installed after April 25, 1940, except outboard motors.	X	X	X	X
<b>Navigational Lights</b>	Required to be displayed from sunset to sunrise and in areas of restricted visibility.	X	X	X	X
<b>Oil Pollution Placard</b>	(a) Placard must be at least 5 by 8 inches and made of durable material. (b) Placard must be posted in each machinery space or at the bilge control station.			X	X
<b>Garbage Placard</b>	(a) Placard must be at least 4 by 9 inches and made of durable material. (b) Displayed in a conspicuous place notifying all on board of the discharge restrictions.			X	X
<b>Marine Sanitation Devices</b>	If there is an installed toilet, the vessel must have an operable MSD Type I, II, or III.	X	X	X	X
<b>Navigation Rules (Inland Only)</b>	The operator of a vessel 39.4 feet (12 meters) or greater while operating on U.S. inland waters must have on board a copy of these rules.			X	X

## Exhaust & Carbon Monoxide

Carbon monoxide (CO) in exhaust can be hazardous, especially from gasoline engines, gasoline generators, grills, stoves, space heaters and on a much smaller degree diesel engines.

CO is a natural by-product of the gasoline engine using an artificial spark. Diesels on the other hand detonate fuel using pressure and temperature. Looking at the two engines another way, gasoline engines use much more oxygen up in the combustion process which contributes to a much higher CO build-up. Although diesels do produce a small amount of CO the combustion process operates with much greater amounts of oxygen which the end result is a much lower CO level.

Ensure that you read the information and follow all the recommendations regarding CO.

Familiarize your crew, passengers and yourself with the sources, symptoms and possible effects of carbon monoxide poisoning. Remember that boats in the same general vicinity can cause your vessel to accumulate dangerous CO levels in the cabin and or in the cockpit.

Note that football shaped Regal's are found on select vessel aft platforms.



These components vent any engine/generator CO trapped under the platform.

 **WARNING**

AVOID SERIOUS INJURY OR DEATH  
FROM CO POISONING!  
DO NOT OPERATE THE BOAT WITH PEOPLE  
HOLDING ON TO THE SWIM PLATFORM  
OR WITH PEOPLE IN THE WATER.

For safety sake avoid the following:

1. Do not park by other boats with their engine idling or generator cycling for an extended period of time.
2. Do not disable the carbon monoxide alarms that come with your Regal boat. Test the units in accordance with the alarm manufacturers instructions.
3. Do not operate an engine for extended periods of time while in a confined area or where exhaust outlets face a sea wall or bulkhead.
4. Do not operate the engine for an extended period of time with the canvas in the upright and installed position.
5. Do have the engine exhaust system inspected when the boat is in for service.
6. Persons sleeping can easily be overcome by carbon monoxide without realizing it. Do not sleep on board while an engine or generator is running close-by.
7. Do not operate your vessel for extended periods with the bow up in slow cruise conditions especially close behind a vessel being towed or one operating at slow speeds.
8. When underway open all hatches, windshield vents, and main cabin entry door to allow proper airflow from bow to stern.



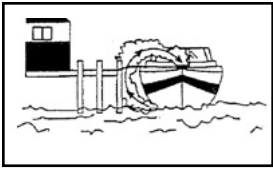

Blockage of exhaust outlets can cause carbon monoxide to accumulate in the cabin and cockpit area even

when the hatches, windows, portholes and doors are open. Sea walls and other confined spaces can cause CO levels to be dangerously elevated.

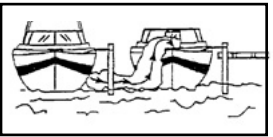

Exhaust from another vessel alongside your boat, while docked or anchored, can

emit poisonous CO gas inside the cabin and cockpit areas.

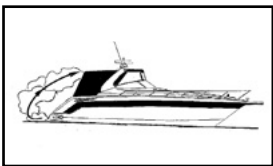

The “station wagon effect” or back drafting can cause CO gas to accumulate inside the cabin, cockpit/

hardtop or bridge areas when the boat is underway, using protective weather coverings (canvas), high bow angle, improper or heavy loading, slow speeds, or at rest. This can occur when traveling behind another boat.

#### How does CO affect us?

In high concentrations, CO can be fatal in minutes. However, the effects of lower concentrations over a extended period of time can be just as lethal.

Our blood uses hemoglobin to carry the oxygen we breathe to different body parts. Unfortunately, hemoglobin carries CO more readily than it does oxygen. The result is when we breathe in CO it replaces oxygen in our blood and we begin to suffocate. Also, when we are removed from the CO source it remains in our blood for hours causing long term effects. People have been known to become sick and even lose consciousness hours after exposure.

Carbon monoxide accumulation requires immediate attention! Thoroughly ventilate cabin and cockpit areas. Determine the probable source of the carbon monoxide and correct the condition immediately. Anyone with symptoms of CO poisoning should be placed in a fresh air environment and medical attention found immediately. Regal has installed CO detectors on your boat. Have these detectors professionally calibrated at regular intervals according to the manufacturer’s recommendations.

#### A Few Notes About Diesel/CO Poisoning

The diesel engine under normal combustion produces much smaller amounts of CO. Therefore, it is far less likely to be fatal to a healthy person. Other factors including weather, temperature and engine condition can greatly affect the unsafe build-up of CO. The best approach is to respect and treat the engine, generator and other vessel components the same way you would a gasoline propulsion system giving particular attention to the sources and possible effects of CO poisoning!

Diesel exhaust in the combustion process produces various components and the captain must be aware that the build-up of these select components over a period of time can cause CO or seasickness like symptoms. These include carbon dioxide, carbon monoxide (CO), nitrogen dioxide, nitric oxide, sulfur dioxide and others. Be careful with boats mooring with engine/generator running overnight. A healthy person breathing in sulfur dioxide over a period of time through a diesel engine or generator exhaust can develop nausea. This condition is not life threatening but the person may exhibit CO poisoning or seasickness symptoms. Just never rule out that it could be CO poisoning! Immediately find the source of the problem and move the individual to fresh air.



Symptoms of excessive exposure to carbon monoxide (CO) are:

- Dizziness
- Drowsiness
- Nausea
- Headache
- Ringing in the ears
- Throbbing temples
- Watering, itchy eyes
- Flushed appearance
- Inattentiveness
- Incoherence
- Fatigue or vomiting
- Convulsions

**! DANGER**

CARBON MONOXIDE IS A TASTELESS, ODORLESS AND INVISIBLE GAS THAT CAN CAUSE DISCOMFORT, SEVERE ILLNESS, AND EVEN DEATH. EXERCISE CAUTION WHILE OPERATING GENERATOR OR ENGINES IN CONFINED SPACES OR AT DOCK SIDE. DO NOT ALLOW HULL EXHAUST OUTLETS TO BECOME BLOCKED OR EXHAUST FUMES CAN BECOME TRAPPED IN AND AROUND THE CONFINES OF YOUR BOAT. DURING IDLE AND SLOW CRUISE CONDITIONS, BILGE BLOWERS SHOULD BE USED.

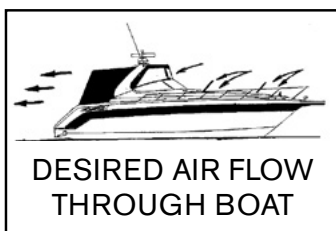

To help prevent carbon monoxide (CO) accumulation, ventilate your cabin and cockpit while

underway. Open a forward hatch, porthole or window to allow air to travel through the boat's interior and cockpit. See the illustration for desired airflow.

*NOTE: Never occupy moored boat with engines running and/or canvas completely covering vessel.*

**! WARNING**

INSPECT THE EXHAUST SYSTEM. IMMEDIATELY REPAIR OR REPLACE LEAKING, CRACKED AND CORRODED, OR MISSING EXHAUST COMPONENTS.

- Before each trip inspect engine, generator and all CO detectors. All must be working properly.
- Make sure all exhaust hose clamps are in place.
- Look for exhaust leaking from the exhaust system components, indicated by rust and or black streaking, water leaks, or corroded or cracked fittings.
- Inspect all rubber exhaust hoses for burned or cracked areas. All rubber hoses should feel soft and be free of kinks.
- Visually verify that water exits at the engine exhaust outlet.
- Keep an ear tuned for changes in exhaust sound that may be an exhaust component malfunction.

Do Not Operate the Vessel If **Any** of the above conditions exist. Contact a marine professional!

**NOTICE**

CARBON MONOXIDE PRECAUTIONARY LABELS ARE LOCATED AT THE HELM, TRANSOM AND CABIN. ENSURE THAT ALL ABOARD READ AND UNDERSTAND THE SIGNS AND EFFECTS OF CARBON MONOXIDE (CO).

## Boating & Alcohol



Operating a vessel while intoxicated became a specific federal offense effective in 1988. The ruling set federal standards for determining

when an individual is intoxicated. If the blood alcohol content (BAC) is .10% (.08 in some states) or higher for operators of recreational vessels being used only for pleasure are subject to a civil penalty up to \$1,000 or criminal penalty up to \$5,000, one year imprisonment or both. In some states the fines and imprisonment may increase significantly.

The effects of alcohol and drugs account for the highest single cause of marine accidents and deaths. Most deaths in boating accidents occur when someone falls into the water. Balance is one of the first things you lose when drinking alcohol or under the influence of drugs. The problem arises out of not knowing your balance is restricted.

Overall vision is reduced by alcohol especially at night, along with double or blurred vision. Peripheral vision is lessened which restricts seeing vessels or objects on the side. Also, color awareness decreases especially with red and green which happen to be the colors of boat navigation lights, buoys, and channel markers.

Alcohol will greatly increase your heat loss so it increases the effects of hypothermia. Finally, your ability to make correct judgements in emergency situations is greatly reduced. Alcohol takes away the brains ability to process information quickly and delays a persons reaction time.

**Don't drink and drive!**

## Alcohol Myths & Facts:

**Myth:** Beer is less intoxicating than other alcoholic beverages.

**Fact:** One 12 oz. can of beer has about the same amount of alcohol as a 5oz. glass of wine or a shot of liquor.

**Myth:** Black coffee, fresh air, and a shower will sober the effects of alcohol.

**Fact:** After consuming alcohol time is the only thing that will sober you up. Our bodies average burning 1 oz. of alcohol every hour. If a person is drunk, it will take a person seven or more hours to sober up.

**Myth:** Telling if a person is too drunk to operate a vessel is easy.

**Fact:** Many experienced drinkers have learned to compensate for the visual effects of alcohol and can disguise their drunk condition.

**Myth:** You can judge if you are fit to operate a boat.

**Fact:** Judgement is one of the first elements you lose when drinking.

## Boating Accidents

The following is a list of common causes of boating accidents. Be aware of them and take the necessary steps to ensure that yourself and crew are educated and prepared to act in an emergency.

1. Mixing boating and alcohol. Remember, the skipper is responsible for his crew, passengers and vessel.
2. Trying to reach the bow by the deck walk-around at unsafe speeds. Use the center walk-through.
3. Someone sitting on the bow, deck, or swim platform while underway.
4. Choosing a boating outing day with inclement weather, especially in high winds and thunderstorms in the forecast or staying out when bad weather is approaching.
5. Disembarking without checking all the fluids or systems, and especially fuel system components.
6. Not monitoring the boating traffic or possible obstructions around you.
7. Emergency communications equipment, signaling devices, and navigation lights not working.
8. Improper boat handling especially high speed turns in rough water. Using trim improperly.
9. Being too far from shore with inadequate fuel supply or navigational aids.

10. Passengers, especially children that are not wearing the proper life saving devices.
11. Skipper or passengers not seated in the boat.

## Reporting Boating Accidents:

According to the Federal Boat Safety Act of 1971 involving collision, accident or other casualty, the operator must make a formal report within 48 hours to the nearest state boating authority when the incident involves:

1. Death
2. Injury requiring treatment other than first aid
3. The disappearance of someone from a boat under death or injury circumstances.

A formal report must be made within 10 days for accidents involving more than \$2000 damage or complete loss of vessel.

For information regarding accident reporting, please call the Boating Safety Hot-line at: 800-368-5647.

*Note if there is no state provision for reporting boating accidents a report must be made to the Coast Guard officer in charge, Marine Inspection Unit nearest to the accident site or USCG station.*

## Federal Regulations- Vessel Security

Federal maritime regulations contain specific information when operating near naval vessels, oil tankers and cruise ships.

1. You may not approach within 100 yards of any U.S. naval vessel, oil tanker, or cruise ship. When this is impossible to avoid, you must contact either the vessel or the Coast Guard escort vessel on channel 16 of the VHF radio.
2. Also, you must operate at minimum speed within 500 yards of these vessels.



# WARNING

**Do not approach within 100 yards of any U.S. naval vessel.** If you need to pass within 100 yards of a U.S. naval vessel in order to ensure a safe passage in accordance with the Navigation Rules, you must contact the U.S. naval vessel or the Coast Guard escort vessel on VHF-FM channel 16.



OPERATE AT MINIMUM SPEED

**You must operate at minimum speed within 500 yards of any U.S. naval vessel** and proceed as directed by the Commanding Officer or the official patrol.

Violations of the Naval Vessel Protection Zone are a felony offense, punishable by up to 6 years in prison and/or up to \$250,000 in fines

## Rendering Assistance

The operator of a vessel is obligated by law to provide assistance that can be provided safely to any individuals in a dangerous situation on the waterway. The operator is subject to fine and or imprisonment for failure to do so.



# DANGER

AVOID BODILY INJURY OR DEATH FROM FALLING OVERBOARD! ALL OCCUPANTS SHALL STAY SEATED IN THE COCKPIT WHILE THE BOAT IS RUNNING.

## Water Sports

Besides learning the safety precautions for safe boating, as well as understanding and knowing required rules and regulations you are obligated to be particularly careful around other water sportsman, such as scuba divers, water skiers, wake boarders, and fisherman.



Whenever you see a “Diver Down” flag maintain a distance of at least 100 feet on inland waters. In bays and

open waters stay 300 feet away. The flag indicates a diver in the water. If a diver is operating from your boat, be certain to use this flag and post a lookout on board to observe the diver’s air bubbles.

## Fishing



Most boaters fish from time to time. With the propulsion systems of today it is possible to fish in out-of-the-way places. When cruising, stay clear of fisherman. They may have lines or nets out which might be cut or get caught in your propeller if you come too close. Slow down when approaching fishing boats. Do not return to cruising speed until the boats have been passed. If a fishing boat should be anchored, a large wake could flip or swamp the boat, upset fishing gear, pull the anchor loose from the bottom or worse yet cause someone to fall overboard.

When fishing from your boat, never anchor in a shipping channel or tie up to any navigational aid. These must be kept clear of at all times. Be sure to carry a local chart of the area to back up your plotter and be on the lookout for shallow water and hidden obstructions. Many times local conditions change and there is a time lag on the plotter chip until the next revision. Pick up a tidal chart if appropriate so you do not end up grounded.



## Weather/Water Conditions



CLOUD FORMATIONS (PETOSKEY, MI.)

Before a boating outing check the weather conditions. As we all know the weather can change rapidly in many parts of the country. It does so sometimes without being predicted. NOAA weather radio reports are continuously available on designated frequencies installed on VHF radios and various hand held devices.

Also, many local radio stations carry weather reports along with on-line information.

### Cloud Formations:

Clouds indicate the type of current weather and upcoming changes in the weather. Knowing the type of cloud formation can assist you in understanding current weather. Flat clouds (stratus) normally indicate stable air. Cumulus clouds indicate unstable air.

Many times a “cotton ball” or cumulus cloud builds vertical height in the afternoon and the result is a thunderstorm with increased winds and waves; sometimes these storms are quite violent.

Also, water spouts with high vortex winds can develop over water. You can find additional weather information (meteorology) on the internet.

## Waves & Fog:

As the wind blows across water waves are created. The stronger the wind and increased distance across the water enlarges the wave action. Other factors that can cause problem situations for vessels are fog, currents, and tidal changes.

Fog can develop inland on clear, calm mornings. Coastal areas see large “blankets” of fog roll in and stay for extended time periods sometimes causing hazardous navigation conditions. If you are caught in the fog, do not panic. Think of the best plan of action and proceed carefully. If you are limited in navigation equipment at the first sign of fog proceed to the nearest shoreline and wait until the fog lifts.

Boats equipped with navigation equipment, local waterway experience and charts should proceed to a safe harbor. Use extreme caution, signal as needed, and reduce to a speed where you can stop within half of your forward vision range.

If foul weather catches you at sea do the following:

1. Slow down. Proceed with caution and put on your life vests.
2. Try to reach the nearest safe shoreline.
3. Navigate your vessel slowly into the waves at a 45 degree angle.
4. Passengers should sit low in the center of the vessel.
5. Monitor your bilge pump. Make sure sump stays free of water.
6. Secure loose gear. Make ready emergency equipment.
7. Anchor over the bow but never over the stern.

# Chapter 3

## Rules Of The Road



The Navigation Rules set forth actions to be followed by boats to avoid collision. They are referred to as the “Rules of the Road”.

There are two main parts referred to as the inland and international rules. The inland rules apply to vessels operating inside the boundaries of the United States. The international rules (referred to as 72 COLREGS) apply to vessels operating on the high seas and all connected waters outside the established demarcation boundaries. Most navigational charts show the demarcation lines by red dotted lines and are published in the navigation rules. Remember to consult state and local agencies since areas such as “no wake zones,” swimming beaches, “diver down flag” and inland landlocked lakes fall under their responsibilities. This section is only an introduction to the “rules of the road”. We strongly recommend additional training before getting behind the “wheel”. Order Inland & International Navigation Rules from:

Superintendent of Documents  
U. S. Government Printing Office  
Washington, DC 20402  
Tel: (202-512-1800) Fax:(202-512-2250)

 **WARNING**

TO AVOID INJURY AND DEATH  
FOLLOW THE NAVIGATION “RULES OF THE  
ROAD” TO PREVENT COLLISIONS.

### Navigation Rules

#### Right Of Way:

1. Cross waves at right angles.
2. When caught in heavy water or squalls, head either directly into the waves or at a slight angle. Reduce speed, but maintain enough power to maneuver your boat safely.
3. Keep your speed under control. Respect the rights of other boaters engaged in all water sports. Give them plenty of operating room.
4. Whenever meeting a boat head on, keep to the right where possible.
5. When two boats cross, the boat to the right (starboard) has the right of way.
6. When overtaking or passing, the boat being passed has the right of way.
7. In general, boats with less maneuverability have right-of-way over more agile craft. The skipper must keep his craft clear of the following vessels:
8. A vessel not under command or aground; due to their circumstances, these vessels have no maneuverability.



9. A vessel restricted in its maneuverability; these vessels usually are performing work which limits their maneuverability. Examples are boats surveying, dredging, laying pipe or cable, or servicing navigational markers.
10. A vessel engaged in fishing; these include boats fishing with lines, trawls or nets, but not trolling lines.
11. Sailboats; they have the right-of-way over powerboats. However, if a sailboat is using a prop to move forward, it is considered a powerboat even if the sails are up.
12. Remember the unwritten "rule of tonnage". Basically a smaller tonnage vessel should take every effort to avoid close quarters with a larger tonnage vessel. One way to accomplish this is to have a designated human lookout to "eyeball" the horizon for any developing collision course.
13. Use defensive driving skills on the waterway just as you do on the roadway. The other vessel may not know the rules of the road. Be alert and ready to take immediate action.
14. If a collision course is unavoidable neither boat has the right of way. Both boats must react to avoid an accident according to the rules of the road.

### Lookouts:

International and Inland navigation rules spell out the specifics of establishing a lookout. A lookout is legally defined by the court system as a person who has specifically charged duties on board such as observing sounds, echoes, lights and any inhibitors to navigation with complete thoroughness as permitted by the circumstances.

The term "specifically charged" means that the lookout has no other duties at that time that could prevent him from keeping a proper watch.

Of course the skipper must delegate the lookout duties to a seasoned crew member who can react to events quickly and communicate effectively with the captain with little notice.

As captain of your yacht you are responsible for the vessel and the crew. Choose an experienced individual as lookout and review the navigation rules with this person so he can make the right call quickly as situations develop.

<b>WHISTLE SIGNALS</b>	
<b>ONE LONG BLAST:</b>	<b>Warning signal</b> (Coming out of slip)
<b>ONE SHORT BLAST:</b>	<b>Pass on my port side</b>
<b>TWO SHORT BLASTS:</b>	<b>Pass on my starboard side</b>
<b>THREE SHORT BLASTS:</b>	<b>Engine(s) in reverse</b>
<b>FOUR OR MORE BLASTS:</b>	<b>Danger signal</b>

<b>BRIDGE SIGNALS</b>		DAY (Flag)	NIGHT (Lights)
<b>SOUND</b>	<b>VISUAL</b>		
VESSEL: Open	—●	□	○
BRIDGE: OK	—●	▽	●
No	●●●●●	Same	or Same
VESSEL: Replies:	●●●●●		
<b>RADIO: VHF CH. 13</b>		No	◀■▶

## Navigation Rules

The Navigation Rules set forth 3 types of crossing situations- crossing, meeting, and overtaking. In each case, both boats are governed by special procedures.

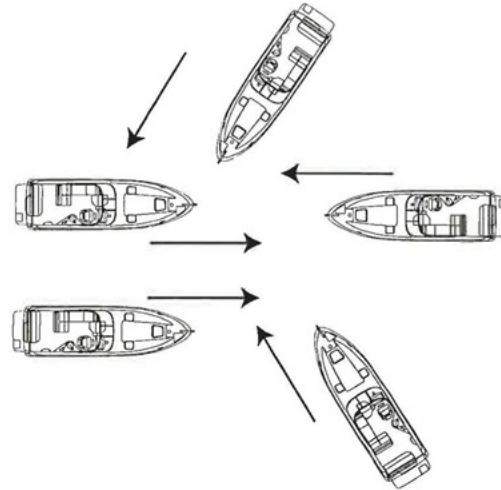

In a head-on meeting, both vessels must sound a single blast to give way toward starboard and pass to port.

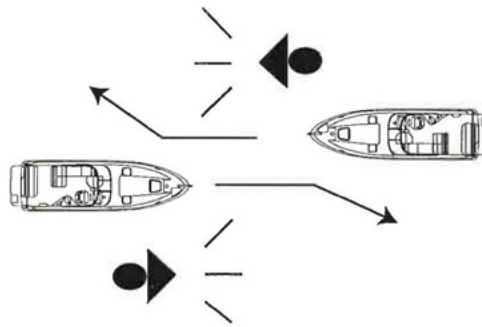

These rules appear when there is a risk of collision. In a crossing situation be aware of the other craft's position. For safety, there should be a noticeable change in the angle, bow or stern; a gradual change in position indicates possible danger.

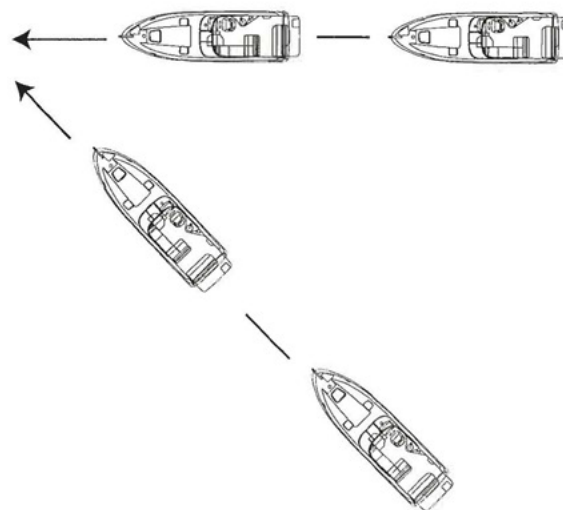

## Navigation Rules

An overtaking boat is burdened, and is not the privileged craft, even though it approaches the danger zone of the overtaken boat.

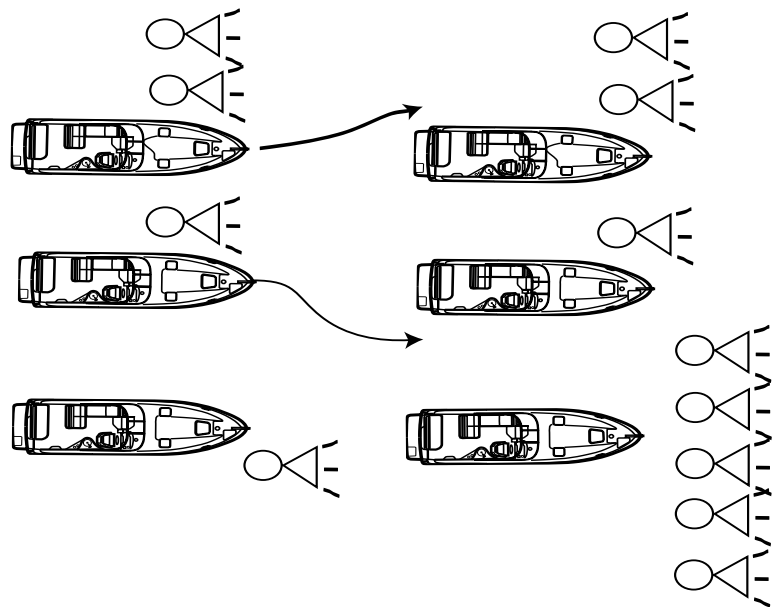
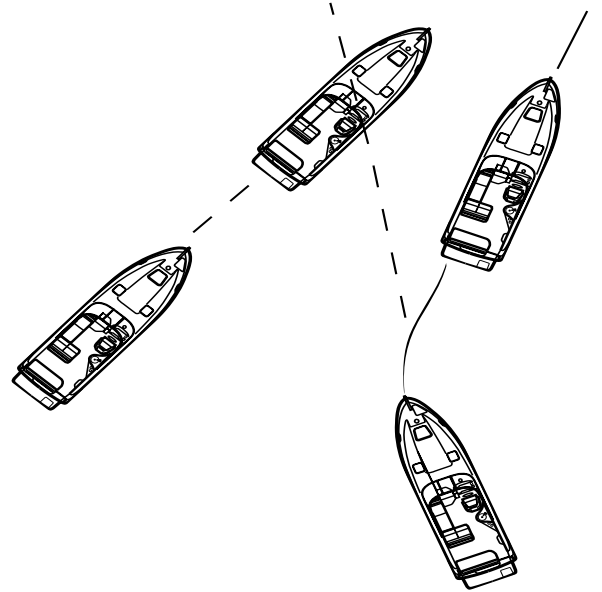

The overtaking boat first signals with a single blast if that boat desires to pass on the starboard side of the boat ahead, or a double blast if passing to port. The overtaken craft responds with the same signal if safe, or with the danger signal (5 short blasts or more) if unsafe. The boat overtaking must not pass unless the appropriate signals are sounded.

## Navigation Aids



Navigation aids are placed along coasts and navigable waters as a guide for mariners in determining their position in reference to land and hidden danger. Each aid provides specific information.

They form a continuous system of charted markers for monitoring on the plotter or providing accurate piloting on paper as a backup.

Your on board plotter provides up to date navigation aids. Besides coastal maps a complete domestic interior waterway grid is featured on the plotter.



NAVIGATION LIGHT(CAN) IN PUGET SOUND, WA.

If desired, there are hand-held GPS devices that are available as back-up devices. In addition, nautical charts are provided by the National Ocean Service (NOS) and are distributed nationwide through marinas and outlet stores. These charts show the geography of the coast, water depth, landmarks, navigation aids (buoys and markers), marine hazards, and port facilities. Use only up-to-date charts for navigation. We recommend when purchasing a chart to look for the weather resistant ones. Buoys provide a road map to keep the skipper on course and to avoid hazards. Buoys are identified by light, shape, color and in severe weather conditions by sound.

Buoys or beacons called lateral markers indicate the port and starboard sides of the waterway to be followed. U. S markers follow the buoy age system known as Red Right Returning. When returning from sea or traveling upstream, the green markers are to port (on your left) and the red markers are to the starboard side (on your right). When traveling downstream or out to sea the marker color would be reversed.

Before operating your vessel, learn to identify the various navigational aids such as lateral aids, mid-channel markers, information and regulatory markers.

## NOTICE

SKIPPERS MUST NOT RELY ON BUOYS ALONE TO MARK THEIR POSITION. SEVERE WEATHER CONDITIONS AND WAVE ACTION CAN ALTER A BUOYS POSITION. NEVER TIE UP TO A BUOY. IT IS ILLEGAL AND DANGEROUS.

# Lateral Aids

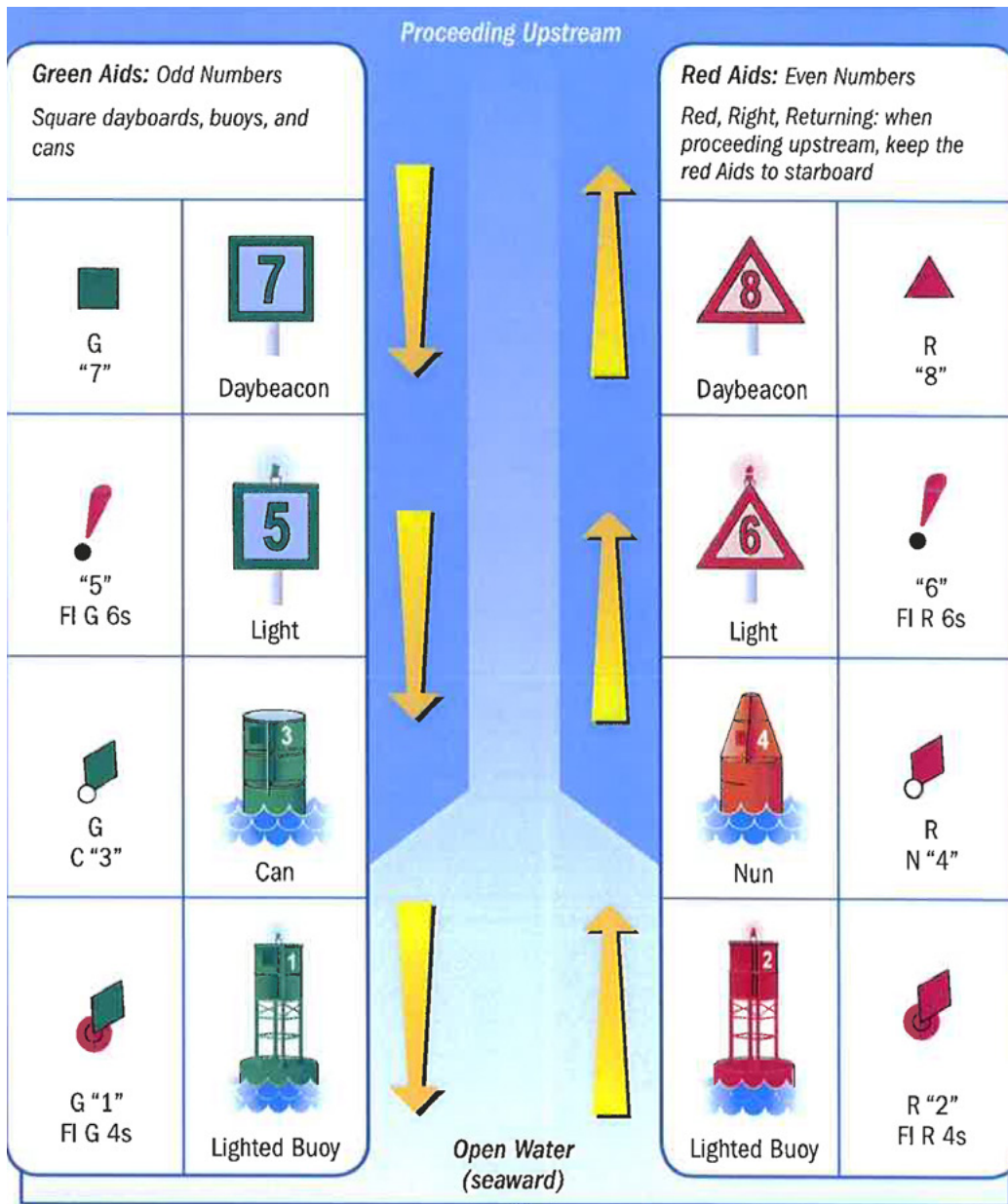

### Characteristics

- Beacons may have green odd numbers.
- Buoys may have white odd numbers.
- If lit, the light will be green and is likely to flash in one of the following patterns:

Flashing (2)	
Flashing	
Occulting	
Quick Flashing	
Isophase	













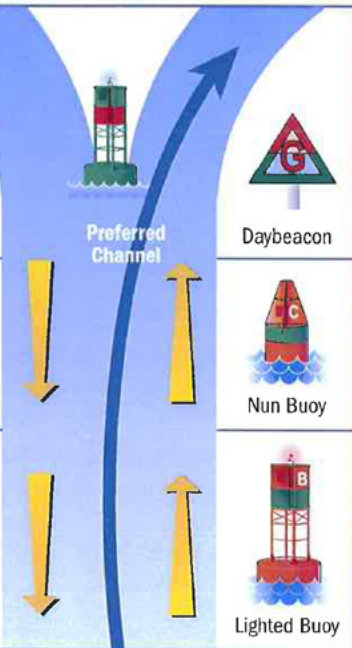

### Characteristics

- Beacons may have red even numbers.
- Buoys may have white even numbers.
- If lit, the light will be red and is likely to flash in one of the following patterns:

Flashing (2)	
Flashing	
Occulting	
Quick Flashing	
Isophase	



# Channel Markers

 GR "U"	 Daybeacon		 Daybeacon	 RG "G"
 GR C "S"	 Can Buoy		 Nun Buoy	 RG N "C"
 GR "A" Fl (2+1) G 6s	 Lighted Buoy		 Lighted Buoy	 RG "B" Fl (2+1) R 6s
<p><b>Characteristics</b></p> <ul style="list-style-type: none"> <li>Green on top.</li> <li>Have a letter designation.</li> <li>Buoys will feature a white letter.</li> <li>If lit:  COMPOSITE GROUP FLASHING (2-1)</li> </ul>			<p><b>Characteristics</b></p> <ul style="list-style-type: none"> <li>Red on top.</li> <li>Have a letter designation.</li> <li>Buoys will feature a white letter.</li> <li>If lit:  COMPOSITE GROUP FLASHING (2-1)</li> </ul>	

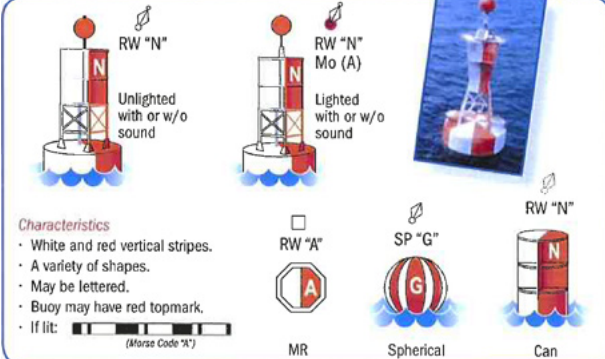













**Characteristics**

- White and red vertical stripes.
- A variety of shapes.
- May be lettered.
- Buoy may have red topmark.
- If lit:  (Morse Code 'N')

MR      Spherical      Can

# Regulatory Markers

Symbol	Meaning	Examples
	<b>Danger</b> A diamond shape alerts boaters to hazards	 
	<b>Restricted Operations</b> Marks with a circle indicate areas with regulated operations	 
	<b>Exclusion</b> A diamond shape with a cross means boats are prohibited from the area	 
	<b>Information</b> Marks with a square provide helpful information such as directions, distances, and locations	 

## Night Running

Boats operating between sunset and sunrise (hours vary by state), or in conditions of reduced visibility, must use navigation lights. Night time operation, especially during bad weather and fog, can be dangerous. All Rules of the Road apply at night, but it is best to slow down and stay clear of all boats regardless of who has the right-of-way.

To see more easily at night, avoid bright lights when possible. Also, it is helpful to have a passenger (appoint as lookout) keep watch for other boats, water hazards and navigational aids.



To determine the size, speed and direction of other vessels at night, use the running lights. A green light

indicates starboard side, and a red light indicates port side. Generally, if you see a green light, you have the right-of-way. If you see a red light, give way to the other vessel.

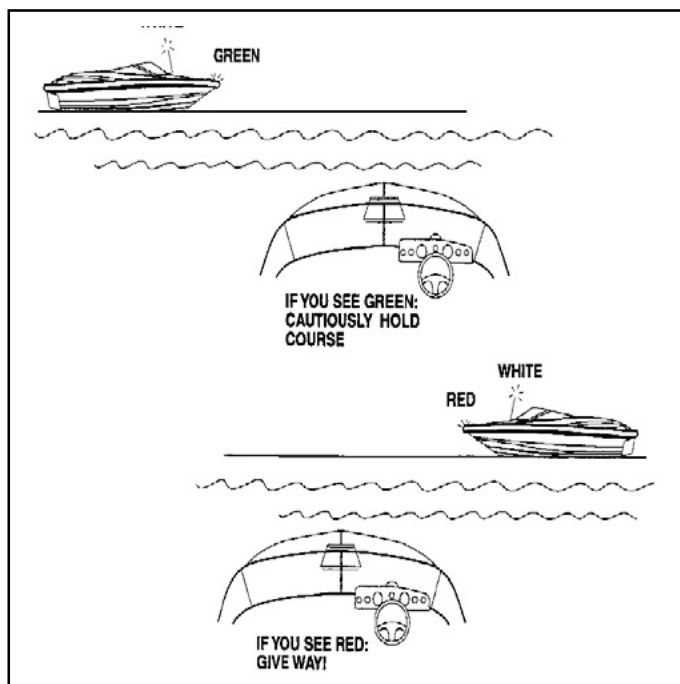

## Bridge Clearance



Be aware that your vessel requires a specified bridge clearance height. This height is a measured estimate from the waterline to the top of the highest equipment height. The estimated height can change because of variances in the loaded condition of the vessel and equipment variances. See the bridge clearance specs in Chapter 12.

Some bridges are tendered. Know and use the proper bridge signals when approaching these bridges (see bridge signals in this chapter). You can also monitor and communicate on channel 13 of a VHF radio for bridge information in most domestic locals. Other bridges are marked with a clearance measurement and you are on your own. Appoint a look out for additional visual assistance when entering a bridge zone.

After determining your vessel will clear the bridge proceed with caution at a safe idle speed. Keep your eye on vessel traffic at all times in order to react quickly. Keep both hands on the helm since you may need to change course because of current and wind conditions. Resume a safe speed once clear of the bridge structure and acknowledgment of clear visibility. Just use common sense!



Bridge lighting is maintained by the Department of Homeland Security. On the following pages are 2 typical examples of night-time bridge lighting.

As the skipper approaches bascule and fixed bridges light position (arc of visibility) and color will indicate the safe channel through the bridge.

Notice green denotes the “safe” entry location on single-span bridges and green or white on multiple-span bridges designates the main channel. In addition, green denotes the “up” position for single and double lift bridges as seen above.

### WHISTLE SIGNALS

**ONE LONG BLAST:** Warning signal  
(Coming out of slip)

**ONE SHORT BLAST:** Pass on my port side

**TWO SHORT BLASTS:** Pass on my starboard side

**THREE SHORT BLASTS:** Engine(s) in reverse

**FOUR OR MORE BLASTS:** Danger signal

### BRIDGE SIGNALS

SOUND	VISUAL	DAY (Flag)	NIGHT (Lights)
VESSEL: Open	—●	↑	↑
BRIDGE: OK	—●	□	○
No	●●●●●	↓	↓ or ↓
VESSEL: Replies:	●●●●●	Same	Same
<b>RADIO: VHF CH. 13</b>		No	No

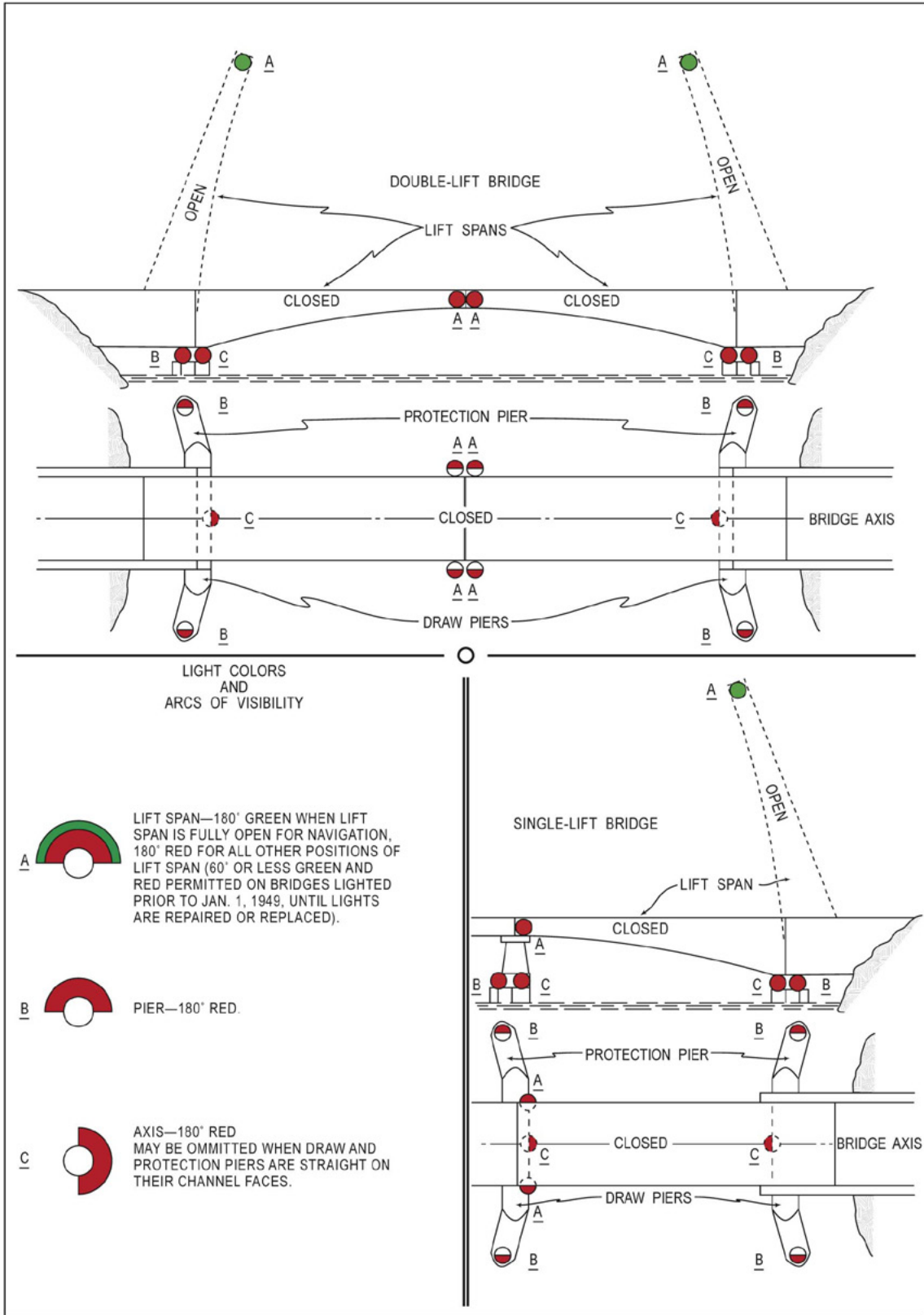



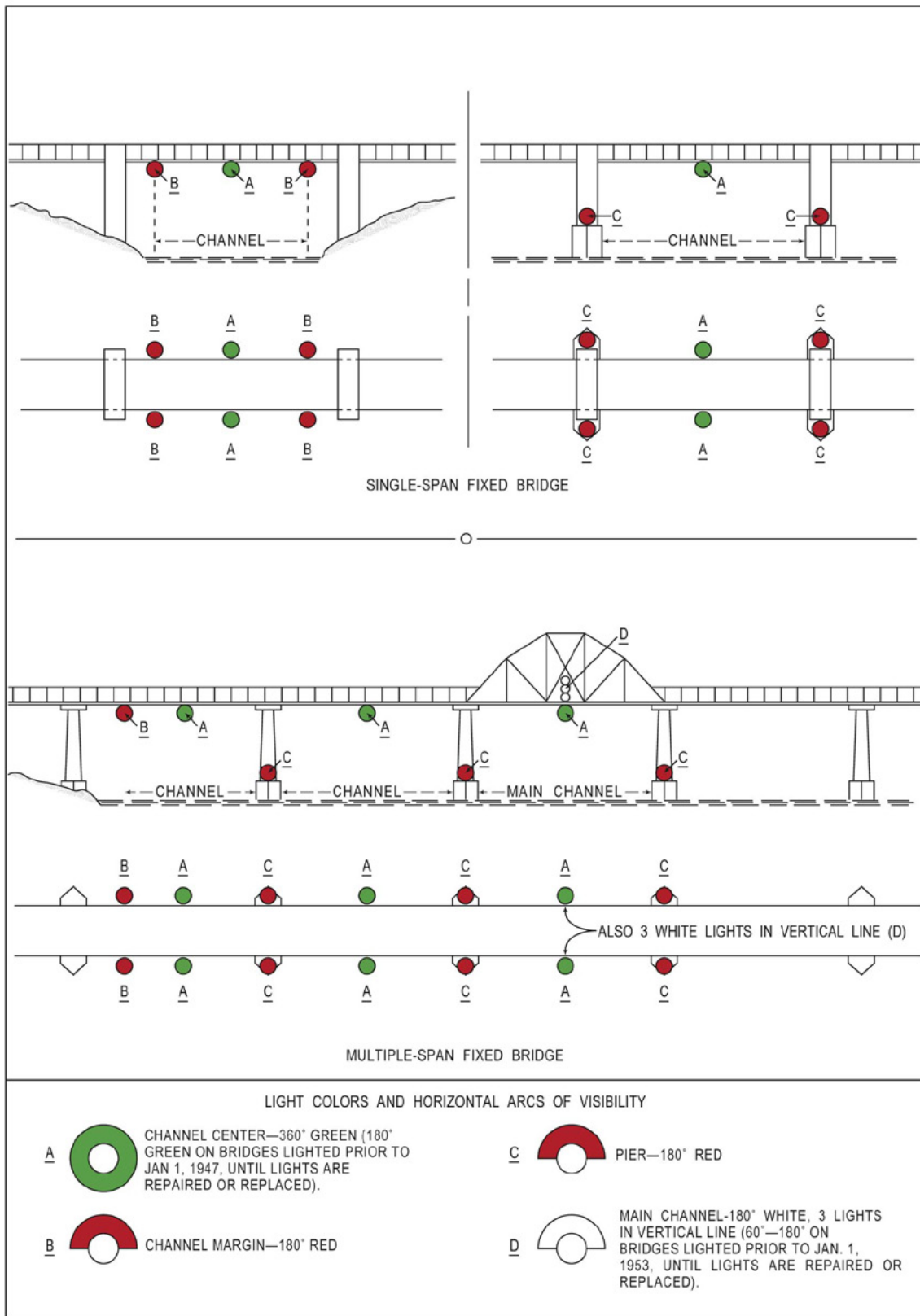



# Chapter 4

## Systems

### Overview

In this chapter Regal on board systems are introduced. Information includes several main systems including fire protection, fuel, electrical, water, waste, electronics, entertainment and trim tabs. In short, this chapter is the “meat and potato” section for “on board” systems.

A system description, location of components, and operational information is found in this section. Enhanced vendor component details and troubleshooting can be found in the owner’s information packet along with the troubleshooting chapter of this manual.

*Be sure to read and follow any danger, warning, or caution labels in reference to boat systems or individual equipment components.*

*Note that your Regal boat may not contain all of the equipment or systems shown. Regal has the right to modify, update or delete equipment and/or systems at anytime. Refer to the vendor documentation located in the owner’s information packet for more detailed information of individual system components and/or the chapter on equipment operation.*

 **WARNING**

PREVENT INJURY OR DEATH!  
READ AND UNDERSTAND THE  
PROPULSION AND GENERATOR OWNER'S  
MANUAL BEFORE ATTEMPTING  
TO OPERATE THE VESSEL.

### Fire Protection

#### Automatic Fire Extinguishing System



Vessels with generators use both a powered ventilation (blower) system and a fire extinguishing system in the sump capable of automatic and manual activation. The dash monitor utilizes an instrument display unit light that provides the operator with a system

status of a charged or uncharged condition by an audible alarm and icons. With the ignition switch on and a no light condition it indicates that the system has been discharged.



If the fire extinguishing system should discharge the ignition system will be instantaneously interrupted and the engines will shut down. See the automatic fire

extinguisher manual in the owner’s packet for additional details.



If a fire has started in the engine compartment the system will automatically discharge or the operator can manually discharge the extinguisher.

*Note: Notice label located on the exterior of a cockpit cabinet alerting crew to the location of the manual release lever.*

## Smoke Alarm



# NOTICE

AUTOMATIC FIRE  
EXTINGUISHER SYSTEM  
MANUAL RELEASE LEVER INSIDE.

Review the location and usage for this component. To use the manual remote remove the safety pin from the “Fire T Handle” and pull firmly on the “Fire” handle which will activate the fire extinguisher unit in the engine compartment. A loud “rushing air” sound may be heard. Complete discharge will take several seconds. Keep the compartment closed for a period of time sufficient to permit the agent to soak all areas of the protected space. This allows hot metals and fuel time to cool. Refer to the automatic fire extinguisher owner’s manual for additional information.

*Note: The boat operator needs to educate the crew on fire protection and more specifically the automatic fire extinguishing system in the event that he becomes incapacitated. It is a good idea to practice by having a mock fire drill.*

A battery operated smoke alarm is installed in the cabin. The unit uses a 9 volt DC battery that can be found at many retail outlets. To access the battery turn the unit counterclockwise to remove the outer unit from the base. Now the battery window can be opened for battery replacement purposes.

It is recommended that the unit be tested on a monthly basis. Press the test button and the horn will sound similar to home smoke alarms.

Should the alarm sound while on board take action immediately. Always have portable fire extinguishers handy. Ensure their gauge is full and contents are within their test date window either stamped on the cylinder or on the attached tag.

For further information read the smoke alarm manufacturer’s operator’s manual.

## Portable Fire Extinguishers

Clean agent extinguishers are primarily for Class B and C fires (gasoline is a flammable liquid under the Class B group). The extinguisher should be of the 5 lb. capacity and 2 are recommended based on the maximum capacity of the fuel tank onboard and the boat length. These extinguishers may be available from your dealer, marine speciality stores, or on the internet. It is recommended to have extra portable fire extinguishers to backup the automatic fire extinguisher system since a fire could take place in an area outside of the sump/machinery space.

As noted above a clean agent type of liquefied gas used today is FE-241. This gas is colorless, odorless, heavier than air and sinks to the lower parts of the sump to extinguish fires. Since the year 2000 ingredients have changed to a more environmental friendly formula such as (Chlorotetrafluoroethane or FE-241). This formula may be selected for portable-hand units available for your vessel.

The canister needs to be weighed once a year. Also, the canister is engraved with a date which is part of the canister life cycle. Refer to the information regarding fire prevention in this manual and on the internet. Normally the clean agent fire extinguishers cost more than powdered or CO<sub>2</sub> extinguishers.

## DC Electrical System

### Overview

In this section, basic DC (direct current) and AC (alternating current) electrical systems are introduced. Select electrical components are reviewed along with their location and function within the electrical system.

For more complicated issues outside the scope of this manual contact your closest Regal dealer. They have undergone extensive training on the Regal boat systems.

Be sure to read and follow any danger, warning, caution, or notice labels in reference to the vessel's electrical system or individual equipment components. Also, refer to the owner's information packet for further product information or the internet.

Your Regal boat uses 12 volt DC electricity otherwise known as direct current. It is called DC because it flows only one way in a circuit. Specifically to name a few, helm displays, batteries, battery cables, engine electrical components, engine wiring harnesses, dash switches, selected lighting, shower sump, bilge pumps, and vacuum toilets are a sampling of components using a 12 volt DC system.

In the domestic DC system the red wire is designated as the "hot" or conductor wire and the black wire is referred to as the ground wire. At times other current carrying wires are color coded such as blue to identify their use as a low voltage conductor. This is especially helpful in troubleshooting and adding additional equipment.

Be sure to review the wiring schematics in the drawing section of the technical chapter before performing any electrical repairs.



## WARNING

PREVENT SEVERE INJURY OR DEATH!  
DISCONNECT  
ALL ELECTRICAL POWER SOURCES  
BEFORE ATTEMPTING  
TO REPAIR OR REPLACE  
ANY ELECTRICAL COMPONENT.



## CAUTION

AVOID CHARGING SYSTEM DAMAGE!  
DO NOT TURN ENGINE AUTOMATIC  
BATTERY SWITCHES TO THE "OFF"  
POSITION WITH THE ENGINES RUNNING.  
THIS INCLUDES THE PORT, STARBOARD &  
CENTER (OPTION) LABELED SWITCHES.

TYPICAL DC (12 VOLT) WIRING COLOR CODE & SIZES		
BLACK	16,14,12,10,8,6,4,2,2/0,40	GROUNDS
BLACK/WHITE	16	HALON INDICATOR
BLACK/YELLOW	10,16	GRD. DIESEL TRANSFER PUMP, MERC DIESEL STOP CIRCUIT
BLACK/WHITE	10	HALON MAIN GRD. FEED
BROWN/BLACK	10	MACERATOR, SUN ROOF
BROWN	10	SUN ROOF
BROWN	14	AFT BILGE PUMP-MANUAL
BROWN/WHITE	14	AFT BILGE PUMP-AUTO
BROWN/RED	14	FWD. BILGE PUMP-AUTO
BROWN/BLUE	14	FWD. BILGE PUMP-MANUAL
BROWN/PINK	16	CO DETECTOR
BROWN/BLACK	16	SHOWER SUMP PUMP
YELLOW	12,10	BLOWER
YELLOW/WHITE	16	HEAD VENT FAN MOTOR
YELLOW/BLACK	16	STEREO MEMORY
YELLOW/RED	14	ENGINE START CIRCUIT

Note: The list above applies to a number of vessels. Actual vessel components/wiring specifications may vary depending on the model.



TYPICAL DC (12 VOLT) WIRING COLOR CODE & SIZES (CONTINUED)		
ORANGE	10,12	VACUUM TOILET, REFRIGERATOR, HATCH RAM
ORANGE	16	WIPER RUN
ORANGE/WHITE	16	WIPER PARK
ORANGE/BLACK	10,12,16	HORN, HATCH RAM
BLUE	14	INTERIOR LIGHTS, SWITCHED CIRCUIT
BLUE/RED	14	INTERIOR LIGHTS, CONSTANT HOT CIRCUIT
BLUE/BLACK	16	COCKPIT SOFT LIGHTS
BLUE/GREEN	16	INTERIOR SOFT LIGHTS
BLUE	10	CABIN LIGHT MAIN CIRCUIT FEED
GRAY	14	NAVIGATION LIGHTS, RUN- NING, BOW, TRANSOM LIGHTS
GRAY/BLACK	14	NAVIGATION LIGHTS, AFT AN- CHOR, MASTHEAD
GRAY/WHITE	14	NAVIGATION LIGHTS, MAST- HEAD, FWD. RUNNING LIGHTS
RED	16	POSITIVE FEED- ELECTRON- ICS, GAS VAPOR DETECTOR, BREAKER TO DASH SWITCH FEEDS

Note: The list above applies to a number of vessels. Vessel components/wiring may vary depending on the model.

TYPICAL DC (12 VOLT) WIRING COLOR CODE & SIZES (CONTINUED)		
RED/WHITE	16	WINDLASS CONTROL-DOWN
RED/BLACK	16	WINDLASS CONTROL-UP
RED/WHITE	14	BATTERY PARALLEL-LOAD
RED	14	POSITIVE FEED-ELECTRONICS
RED	12	POSITIVE FEED-ELECTRONICS
RED	10	POSITIVE FEED-AUTO PILOT
RED/VIOLET	10	FUEL TANK TRANSFER PUMP AMPLIFIER POWER
RED	8	POSITIVE FEED- MAIN ALTERNATOR CHARGE
RED	6	POSITIVE FEED- MAIN ALTERNATOR CHARGE
RED	4	POSITIVE FEED-MAIN
RED	2	POSITIVE FEED- MAIN STARTER, BATTERY, GENERATOR
RED	2/0	POSITIVE FEED- MAIN, START- ER, BATTERY
PURPLE	16	STBD. IGNITION, HOUR METER- WINDSHIELD VENT
PURPLE/WHITE	16	PORT IGNITION, HOUR METER, WINDSHIELD VENT
PINK	16	STBD. FUEL TANK SENDER
PINK/BLACK	16	PORT FUEL TANK SENDER
TAN/BLUE	16	ENGINE ALARM CIRCUIT
GREEN	16	TANK LEVEL MONITOR, SPOT- LIGHT
GREEN	10	SPOTLIGHT
GREEN	8	BONDING

Note: The list above applies to a number of vessels. Vessel components/wiring may vary depending on the model.

## Batteries

All vessel DC equipment and specifications are subject to change at any time as part of Regal's commitment to product improvement.

Equipment shown here and information is up to date per the manual printing date. Read the following pages and view the accompanying photos relating to the onboard battery system components as the battery system is the “meat and potatoes” of the direct current (DC) system.

*Note that we will review various battery system components onboard the vessel in multiple locations although many of the items are located in the sump.*

### Battery Terminology Descriptions

Group- Batteries are divided into groups which identify the height, length, and width of the battery. This is useful information should a replacement battery become necessary. Note that your vessel currently uses 31-A batteries for engine cranking needs and 8-D batteries as house and house accessory deep cycle needs.

Cold Cranking Amps (CCA)- This rating measures the cranking power of a full charged marine battery having the ability to start at 32 degrees F. Basically, the higher the rating the greater starting power of the battery.

Reserve Capacity (RC)- As usage on the boat increases so does the need for more reserve capacity. The reserve capacity represents the length of time in minutes a new fully charged battery can maintain the vessel's electrical needs without the engine running or in the event a stator failure.

BATTERY SPECIFICATIONS			
Battery Type	Group	CCA @32 Degrees F.	Reserve Capacity
Engine Cranking	31 A	1260	195 min.

BATTERY SPECIFICATIONS			
Battery Type	Group	CCA @32 Degrees F.	Reserve Capacity
House/ House Acc.	8 D	1400	430 min.

### Battery System Introduction

*Note that periodic maintenance of batteries is needed especially in warmer climates. Contact your closest Regal dealer or marine professional for additional information on battery system care.* Direct current is stored in the ship's batteries and produced through the engine stators while the engines are running or by the battery charger at dockside. The outboard stators charge the batteries by sending current through the main distribution panel relays, battery switches and harnesses to the appropriate battery. Normal DC voltage is between 12 and 15 volts. Lower or higher readings could indicate a charging malfunction or a weak battery. There is a special output wire for output stator voltage that travels from the alternator to each of the battery switches (orange #4 wire).

*Note that current specifications for alternator output at WOT (wide open throttle) is 50-70 amps for each 350 Yamaha outboard and 90 amps for each 425 hp Yamaha outboard. Information and models subject to change.*

## House Battery Notes

There are two house batteries located in the sump on your vessel. One is called out as the “house main” battery and the other is known as the “house accessory” battery. They are both group 8-D type batteries. They weigh approximately 128 pounds each. Both feature long reserve capacities.



TYPICAL GROUP 8 D HOUSE BATTERY

Many of the DC lighter amperage draw component circuits use the “house” battery sometimes called the house main. Examples are bilge pumps, macerator, fresh water pump, and lighting circuits. Several of the DC heavier amperage draw component circuits use the “house accessory” battery. These include as installed a stabilizer (Seakeeper), bow thruster, windlass, and generator. All 8 D batteries in your vessel are presently of the flooded lead-acid variety.

### Main House Battery Breaker



Since the main house positive battery cable run is longer than 6 feet there is a 200 amp breaker located in the aft port sump to cover this requirement.

## Engine Battery Notes

As part of the standard engine propulsion package each engine features a designated group A 31 starting battery. These batteries each weigh approximately 45 pounds and offer plenty of cold cranking amps for engine starting. All 31 D batteries presently on your vessel are of the flooded lead-acid type.



TYPICAL GROUP 31 A ENGINE BATTERY

*Note that Red is + or positive and black is - or negative for DC battery cables. Always observe correct polarity when reconnecting battery cables especially after a battery has been removed from the vessel for charging. Normally in assisting the installer a positive + is marked on the positive battery post.*

Always reinstall red battery post covers (boots) after a battery is charged or serviced.

Use only distilled water to fill lead -acid batteries.

*Note when replacing marine batteries do so in matched sets as one old battery in a 2 battery set will eventually weaken the newer battery. Never mix one group type battery with another group type on the same battery circuit. Also, never mix flooded lead-acid batteries with gel batteries as it will effect the battery charger's ability to perform properly.*

## Battery Problems/Solutions



1. Weak battery- This battery problem can be caused by low electrolyte cell levels.

Warm bilge compartment area temperatures will deteriorate a battery's life quicker by evaporating the water from the electrolyte, thus corroding and weakening the positive grids inside the battery.

With the house battery low electrolyte levels can be monitored by periodic inspection and filling as needed with distilled water. Boaters in higher climate areas with longer stretches of hot weather will need to check their batteries more often.

The "maintenance free" engine cranking batteries require no water. They do feature a different chemistry that does consume less water. Inside the cells as gases are released condensation is formed which aids in maintaining the cell electrolyte level. These batteries incorporate a deeper layer of electrolyte over the plates, but eventually it can run dry. On the 31 series engine cranking batteries keep all terminals clean, connections tight and your electrical system in top shape to extend battery life.

2. Dead Battery- Either the battery will not accept a charge, hold a charge or the charging system is not supplying a charging current through the battery charging system and/or engine stators.

The battery charger output can be checked by monitoring the lights on the charger front face.

To begin with check the battery post connections for tightness and corrosion.

With the engines running the displayed voltage of the port or starboard engine battery and house battery should be between 12.5 up to 14.6 volts.

If less than 12 volts check for voltage across the battery terminals.

If less than 12 volts on the house battery use a hydrometer to locate faulty cells.

On maintenance free batteries they can be removed from the vessel if necessary and trickle charged. If readings after charging are still low replace the battery.



## Battery Activation Panel

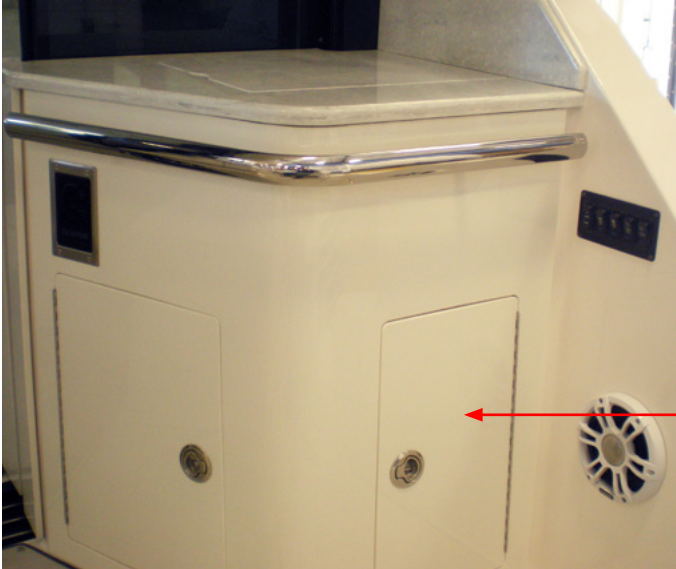

ACTIVATION PANEL (EARLIER) INSIDE CABINET

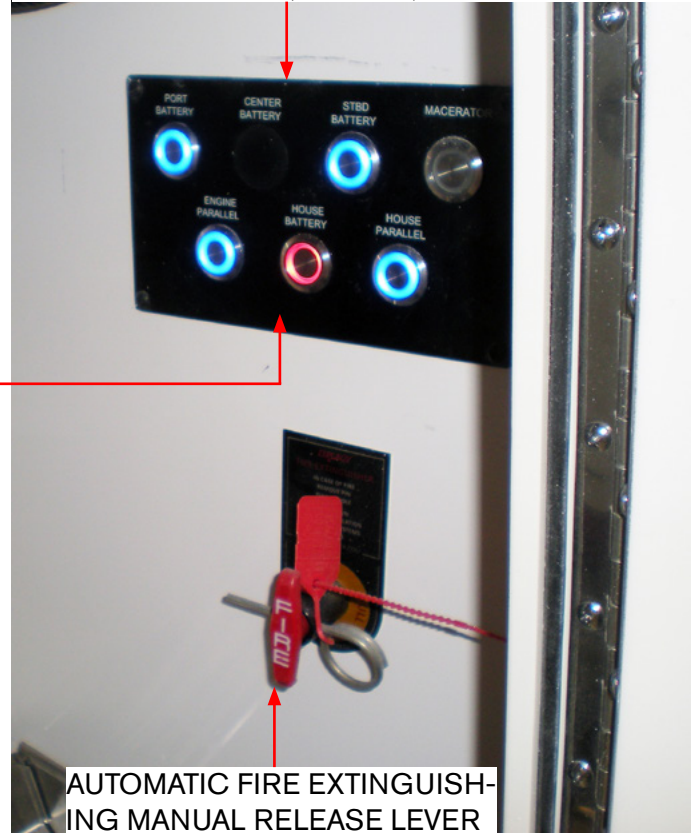

### Introduction

The battery activation panel is a major game player in reference to the vessel's battery system. The panel is currently located inside the cockpit starboard aft cabinet mounted on the wall.

The battery activation panel controls 2 engine batteries depending on which propulsion package is utilized on the vessel. Each engine is provided with an individual switch to control the battery and starting functions for that engine.

The battery port and starboard battery switches when activated permit individual engines to be started. The battery activation panel footprint also includes a house battery switch.

In addition, the battery activation panel permits battery parallel functions when an engine or house battery is in a low charge condition. **Read the information on the following pages regarding the engine battery parallel and house parallel battery features.**



TYPICAL EARLIER BATTERY ACTIVATION PANEL

### Battery Activation Panel (Earlier)- Operation

**Earlier Panels-** Each button displays a continuous blue ring *when power is available to that button function.*

When a button is depressed to activate a switch the blue lit ring changes to a red ring indicating that current is flowing through the entire circuit. *For example, when the stbd. battery button is depressed the lit blue ring changes to red indicating the starboard engine battery circuit is engaged and it is ready for starting the starboard engine. In the course of depressing the button a magnetic induction process at the starboard automatic battery switch (located in the sump on the battery switch board) occurs due to current in the circuit pulling a magnetic latch down and holding the automatic battery switch in a closed position. This permits starboard engine battery availability to start starboard engine.*

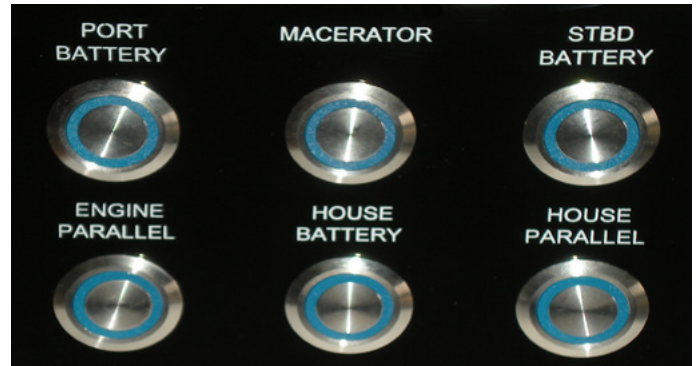

TYPICAL LATER BATTERY ACTIVATION PANEL

### Battery Activation Panel (Later)- Operation

**Later Panels-** Each button displays a continuous color *only when the button is depressed.*

When a battery switch is depressed the switch will emit a blue color.

When a parallel switch is depressed the switch will emit a red color.

## Battery Activation Panel Button Operation- (Continued)

**Macerator-** This switch as shown on the previous page in a normal “off” position displays no colored ring. When the overboard discharge pump (macerator) key switch is turned to the “on” position at the ship’s main DC panel the battery activation panel button labeled macerator will show the blue lighted ring.

Remember that pumping waste overboard requires a 2 step process to complete the cycle. After the key switch is turned to the “on” position the macerator button at the battery activation panel can be depressed to start the waste pumping process. While the macerator pump is cycling the macerator button at the battery activation panel will display red.

### Battery Activation Panel- Button Functions

**Port Battery-** This switch when depressed completes a circuit to the port engine battery through the port automatic battery switch on the battery board. This permits port engine starting.

**Center Battery-** (Triple outboards only). This switch is plugged on earlier panels and non-existent on later twin propulsion battery panels. This switch when depressed completes a circuit to the center outboard engine battery through the center automatic battery switch on the battery board. This permits center outboard engine starting.

**Stbd Battery-** This switch when depressed completes a circuit to the starboard engine battery through the starboard automatic battery switch. This permits the starboard engine to be started.  
*Note that the engine battery type is a group A-31.*

**House Battery-** This switch when depressed completes a circuit to the house batteries which includes both the house main and house accessory units. Current runs through both the house and house accessory automatic battery switches.  
*Note that both house batteries are group 8-D.*

Read and understand the following label regarding using the battery parallel functions on the battery activation panel.

<h1>NOTICE</h1>
<p>THE BATTERY PARALLEL FEATURES ON THIS VESSEL ARE INTENDED FOR EMERGENCY INTERMITTENT USE ONLY! WHEN A PARALLEL FEATURE IS REQUIRED IT MAY INDICATE A SERVICE BATTERY IS NEAR THE END OF ITS USEFUL SERVICE LIFE.</p>

**Engine Parallel-** This switch when depressed will parallel (combine) the port engine battery to the starboard engine battery for emergency intermittent use.

**House Parallel-** This switch when depressed will parallel (combine) the “house main” battery to the starboard engine battery. In addition, it will parallel the “house accessory battery” to the port engine battery for emergency intermittent use.



## Main Ship's DC Panel (Typical)

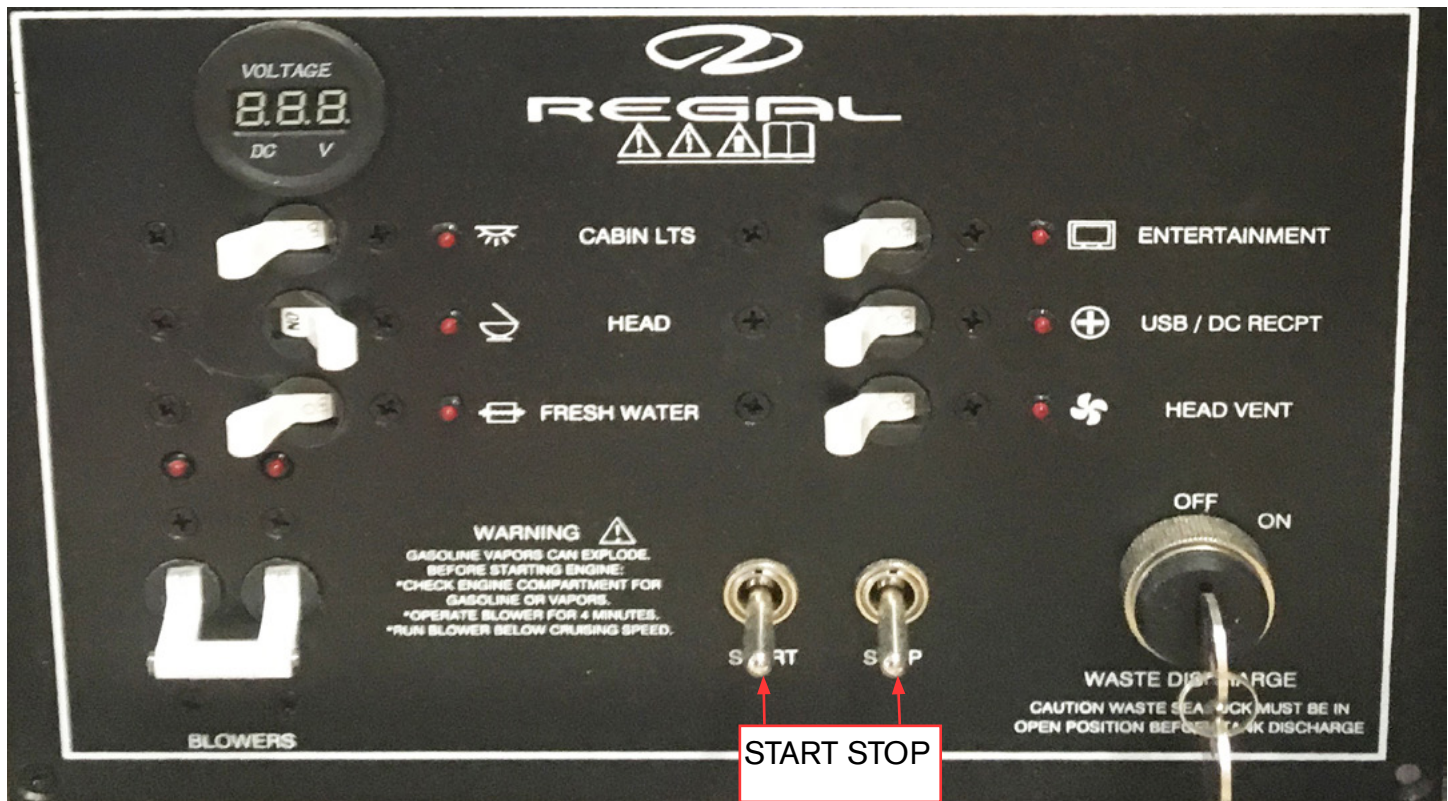

The ship's main DC panel is located at the port side cabinet at the bottom of the cabin entrance steps. Open the cabinet door to access.

*Note the DC panel features a digital DC voltmeter.*

Following is a brief description of breaker switches and their function along with other components displayed at the panel.

12 Volt DC- Displays available DC voltage

Cabin Lts- This breaker switch controls the DC light fixtures in the cabin such as reading, overhead, and courtesy LED types which are controlled by switches at various wall plate locations.

Head- This breaker switch controls the vacuum style toilet function.

Fresh Water- This breaker switch controls the on board potable (fresh) water system pump.

Blowers- This double pole switch controls the powered ventilation system. **Read and understand the warning information next to the switch.**

Entertainment- This breaker switch controls the satellite television booster box which will supply a signal through the antenna to the satellite television network. Furthermore, when the television is activated the signal is displayed on the screen.

## Main Ship's DC Panel (Con't)



USB/DC Receptacle- The breaker switch protects the various USB ports found through out the vessel. Also, the switch controls any 12 volt plugs which are available to activate accessories such as portable spotlights, etc.

Head Vent- This breaker switch controls the powered ventilation fan in the head. The switch is mounted on the head wall.

Key switch- The key when in the "on" position permits the overboard discharge pump to operate as the macerator switch is activated at the main battery activation panel.

Generator Start/Stop Switches- These switches control and starting and shutdown generator functions. See the generator section for further information.



## Direct Current (DC) Distribution Panel



### Introduction

The DC distribution panel located on the battery management panel in the bilge provides over current breaker protection for numerous standard and optional equipment components along with protecting the house and engine battery automatic remote battery switches located in the bilge (sump). The distribution panel uses thermal circuit protection which utilizes a bimetallic strip electrically in series with the circuit.

*Note that these types of breakers can be reset after tripping and therefore have a significant advantage over fuses. Always find the cause of a tripped thermal breaker before resetting it.*

Contact your closest Regal dealer to order breaker replacements as they need match the original equipment amperage requirements.

Refer to the following page for component breaker amperage. For information on resetting the amplifier breakers refer to the illustrations in the next couple of pages.

## Direct Current (DC) Distribution Panel (Rear View) Breaker Amperage

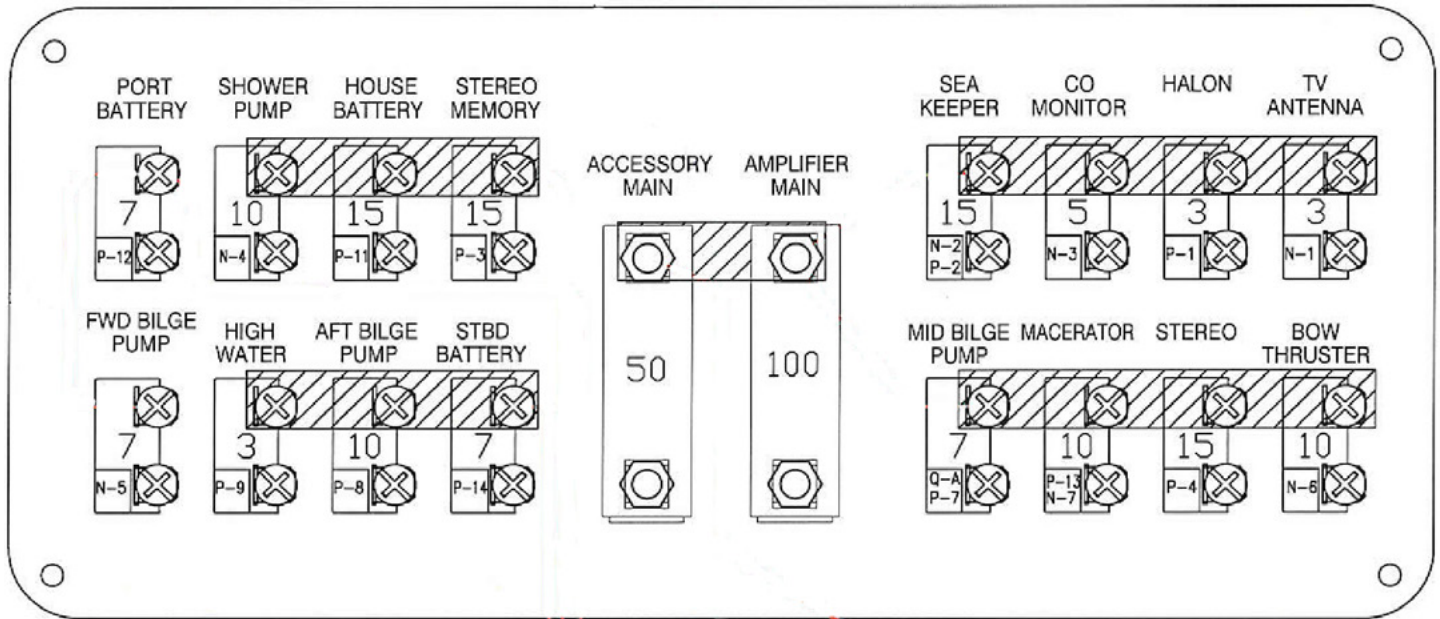

### Introduction

The DC distribution panel amperage is up to date per the manual printed date on front page. Over the production life of a vessel vendor components may change in design along with current requirements. As a part of a constant quality upgrade Regal reserves the right to change product components, specifications, and dimensions as needed. Always contact an authorized Regal yacht dealer to order the correct electrical parts for your vessel. Remember that select after market components especially automotive electrical replacement products may not meet marine ignition protection and watertightness requirements.

## Typical DC Distribution Panel-Resetting Breakers



1. It is possible that one of the DC distribution system amplifier breakers may trip from long-term arcing and heat.

To trip and/or reset this style of breaker do the following:

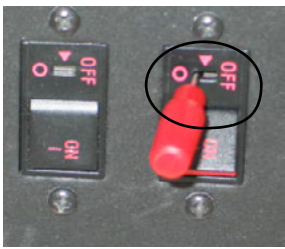

A. Take a small slotted insulated screwdriver from your on-board tool kit and insert it in the breaker slot until it trips. You will hear a snapping type noise. See the illustration.

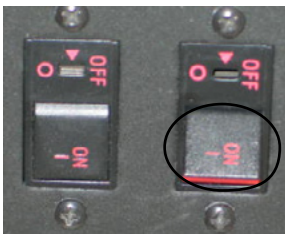

B. Notice that the breaker has pushed outward from its original flush position indicating the breaker has been tripped. See the illustration.

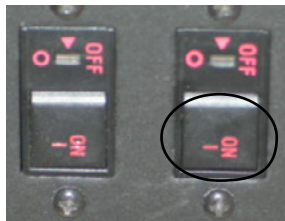

C. To reset the breaker use your finger to press the breaker down until it locks in the “on” position. You may hear a slight noise.

This is normal. The icon display should be lighted after this procedure. See the illustration.

2. Breaker will not reset- Replace the breaker. Contact the nearest Regal yacht dealer for replacement parts.

3. Breaker continues to “trip”. Check the affected equipment to determine if it is responsible for the excessive draw to trip the breaker. If the equipment is determined to be within specifications check for a “short” in the wiring circuit. Also, the breaker may be faulty. Contact the closest authorized Regal dealer for service and parts.

Note: It is possible under certain circumstances that a breaker may preform a “soft” trip on a circuit. The breaker may not appear to be in the tripped position but at this point current to dedicated components in this particular case is interrupted.

It is recommended to turn any equipment on the circuit to the “off” position until the breaker is reactivated. In this situation insert the insulated screwdriver blade into the breaker slot until it fully trips the breaker. Then reset the breaker by pushing the breaker down until it clicks into place. At this point energize the circuit by activating components or equipment.



# 36 GC (STERN DRIVE) BATTERY MANAGEMENT PANEL WIRING SCHEMATIC AS OF 5-4-2020

7/23/2020

VJ Battery Management System EL-128.jpg

Subject Work Instruction:	Issue Date:	Rev:	Document No.
VJ Battery Management System	05/04/2020	1	EL-128
Approved By:	Written By:	Rev Date:	Page:
Mark Journey	Kyle Quatman	07/23/2020	1 of 1

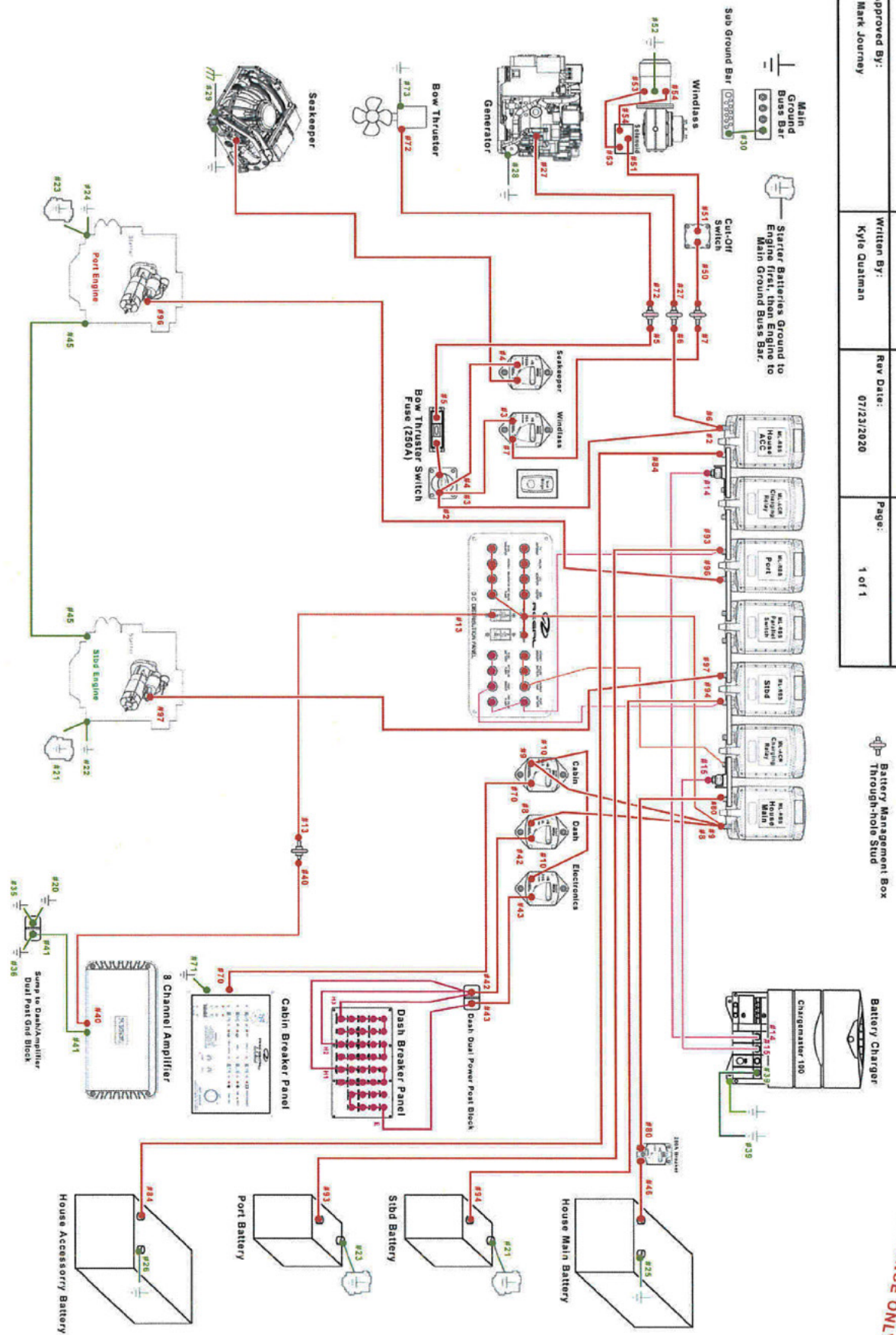

[ REFERENCE ONLY ]

## Typical Automatic Remote Battery Switches-Overview

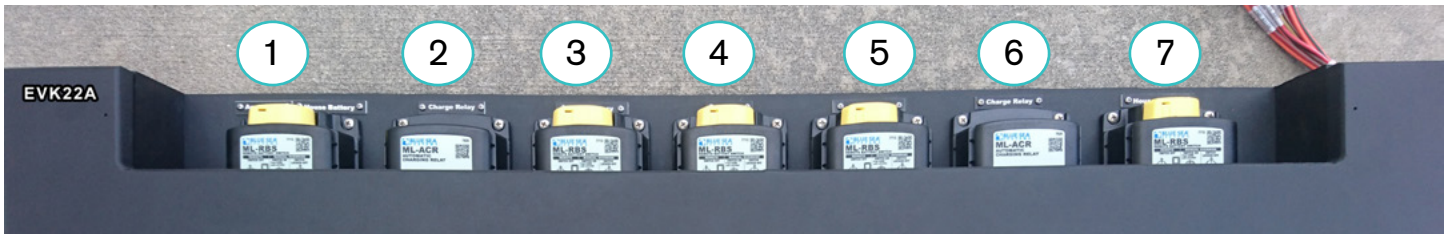

### Introduction

The battery management panel (shown above) used on stern drive and outboard vessels features a set of heavy duty remote battery switches which are connected through the battery activation panel. When activated by the battery activation switches individual engine cranking and house battery functions are energized. Also, battery parallel circuits are connected as the parallel buttons are activated on the battery activation panel.

The remote battery switch circuits are charged by the alternator/stator system when the engines are running and by the battery charger when shore power is utilized.

*Note that a 50 amp battery charger is standard and when the stabilizer option is installed a 100 amp charger is standard.*

There are 3 battery charger wires that carry current as needed to the house accessory, house main and engine cranking battery circuits.

Over current protection for battery charger wires for the house accessory and house main circuitry is provided by a 60 amp cube fuse located on the remote battery switch stud. When the optional stabilizer is installed a 125 amp cube fuse replaces the 60 amp standard cube fuse.

*Note that when the stabilizer option (Seakeeper) is installed a 100 amp battery charger replaces the 50 amp battery charger. A 100 amp cube fuse replaces the smaller cube fuse on the charger leg.*

Located on the bottom of remote battery switches are switch link plates which connect battery switches and assist in charging current bleeding through to all connected battery circuits.

***The main difference between the stern drive and outboard battery panel is that the outboard includes Aux. charge circuits. Refer to system information and drawings on following pages.***



## Remote Battery Switch Description

**1. Accessory House Battery-** This remote battery switch is connected to the largest DC amperage components that may be installed including the bow thruster, windlass, generator and stabilizer (Seakeeper). One of the battery charger legs is connected to this battery switch to provide charging current to the accessory house battery when on shore power. With the engine running a dedicated stator charging output #6 wire is connected to an Aux. charge breaker and then supplies current to the accessory house battery.

**2. Charge Relay-** This is known as an ACR switch which translates to Automatic Charging Relay. This device permits charging current to be shared between the accessory house and port engine batteries bleeding through the tin copper plates attached at the bottom of the remote battery switches. It also allows paralleling of battery banks for emergency starting through the battery activation panel. It isolates batteries when discharging and starting the port engine.

**3. Port Battery-** This remote battery switch is connected to the port engine starting battery circuit.

**4. Parallel-** This remote battery switch parallels the port and starboard engine batteries for emergency starting by depressing the engine parallel button at the battery activation panel. In addition, there are take-off lugs for the port and starboard steering circuits.

**5. Stbd Battery-** This remote battery switch is connected to the starboard engine starting battery circuit.

**6. Charge Relay-** This is known as an ACR switch which translates to Automatic Charging Relay. This device permits charging current to be shared between the house main and starboard engine batteries. It also allows paralleling of battery banks for emergency starting through the battery activation panel. It isolates batteries when discharging and starting the port engine.

**7. House Battery-** This remote battery switch is connected to the house main battery. One of the battery charger legs is connected to this battery switch to provide charging current to the house main battery when on shore power. With the engine running a dedicated stator charging output #6 wire is connected to an Aux. charge breaker and then supplies current to main house battery. There is also a take-off lug for the house battery to dash breaker.

**Aux Charge Breakers-** Note that the outboard battery panel features 2 auxiliary charge breakers (See photo below). The stern drive version does not contain nor require these breakers. A dedicated #6 charging wire is integrated into the port and starboard Yamaha outboard engine harness (one wire for each engine) to carry charging system current to the Aux. Charge circuit breaker and on to the appropriate battery circuitry.

## Typical Remote Battery Switch Operation

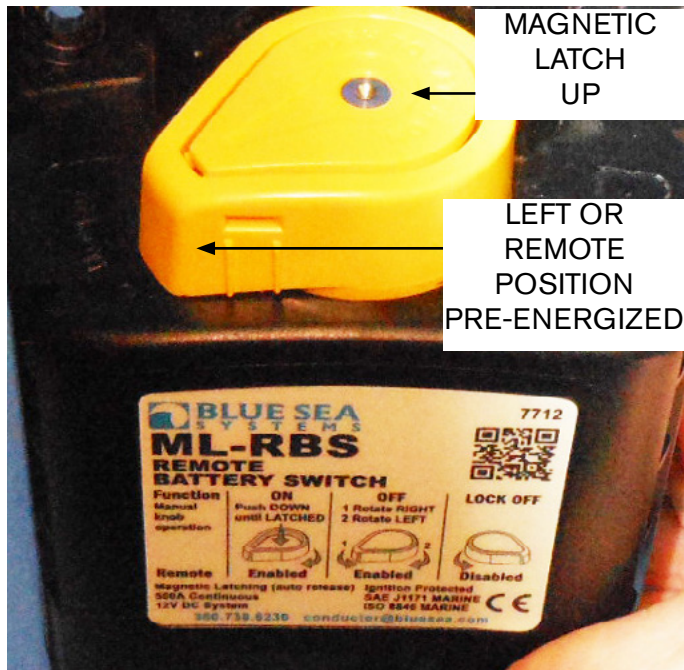

1. Normal operation of the remote battery switch is completely to the left in the auto or “remote” position. Notice latch position is up (manually disengaged). To energize the house circuit press the appropriate switch at the battery activation panel. Once the switch is energized the magnetic latch will be pulled down in the energized position.

2. If the remote battery system fails for some reason the skipper can override the remote battery switch manually through the magnetic latch which is located on top of the switch. Just turn the switch to the left and push the magnetic latch down until it engages.

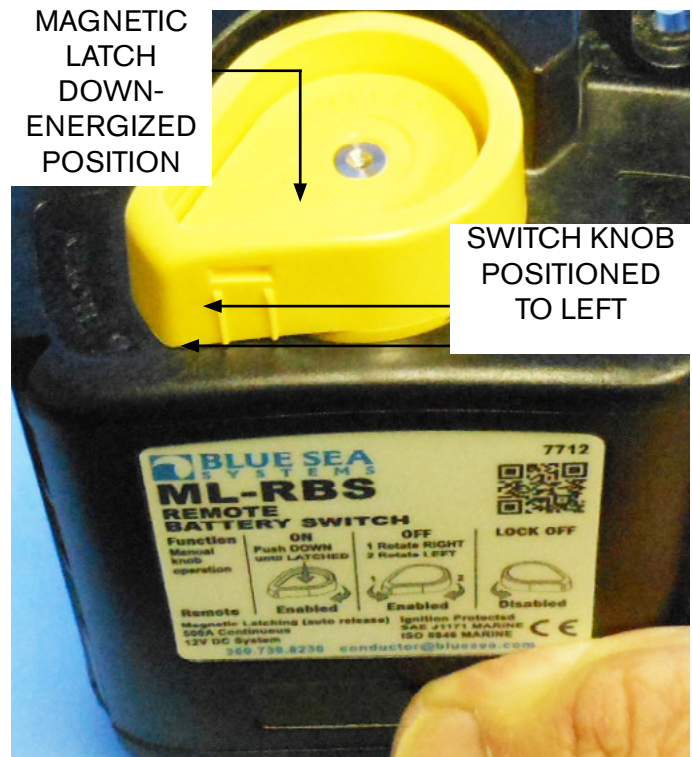

3. In the event of servicing the house battery components turn the remote battery switch to the right (Lock or Off Position). Pass a tie wrap through hole to secure the remote battery switch knob until servicing is complete.

## Remote Battery Switches, Charging Functions & Battery Management

If a remote battery switch is positioned as shown below (straight out, OFF position) that particular battery or connected battery bank will be **inoperative**. This positioning could effect both starting and house battery circuitry. After sump maintenance or electrical repairs always check the battery switches to ensure switches are in “on” remote position.



2. When operating the optional Seakeeper (stabilizer) make sure to run generator to charge the house accessory battery.

3. Periodically check all battery hardware for tightness and ensure battery electrolyte is up to required cell levels and only use distilled water for filling lead acid types of batteries. Wear proper eye wear and gloves when servicing battery systems. Read the maintenance chapter for more information.

4. Periodically check all battery bank hardware for tightness and corrosion. Maintain as needed.

5. **Always turn off the battery switches at the battery activation panel before leaving vessel.**

6. For safety sake, charge all batteries outside of the vessel to eliminate possible hydrogen gas build-up in the sump and sparks from battery charger/leads.



## Typical Battery Board Circuit Breakers/Components

Note: your battery board display may vary from photo



1. **Stabilizer-** This 100 amp breaker provides over current protection for optional Seakeeper circuit.

2. **Windlass-** This 90 amp breaker protects the windlass circuitry installed at the foredeck.

3. **Mid Bilge Pump-** This breaker protects the middle bilge pump located under the cabin floor. Note bottom portion of switch is automatic position and top portion of switch is manual position.

4. **D.C. Distribution Panel-** This breaker panel protects both standard & optional equipment. See previous pages for detailed description of panel.

5. **Cabin Main-** This 60 amp breaker protects the cabin main DC circuit to DC cabin panel.

6. **Dash Main-** This 30 amp breaker protects the main DC circuit to the helm.

7. **Electronics-** This 50 amp breaker protects the electronic component circuitry which may include plotters, video camera, VHF radio, radar, Garmin remote, ACC 1 and NMEA backbone as installed.

8. **Bow Thruster Fuse-** Protects the high amperage thruster circuit with a 200 amp DC fuse.

9. **Bow Thruster (Option)-** This switch activates or deactivates the bow thruster system used to maneuver the vessel.

10. **Auxiliary Charge Breakers- (Outboard Only)** The 80 amp breakers provide over current protection for each outboard stator output charging circuit. One breaker is utilized for each engine charging battery.

### Outboard Vessel Only



## Battery Board Component Feed Stud Blocks/Harness Plugs



On the ends of the battery board display are stud attachment points for heavier amperage components. These feeder studs exist by component and your vessel may not incorporate all of the stud attachments as that component may be optional and not installed on your vessel.

On one end the windlass, generator and bow thruster use these connection points for their larger gauge feed cables. All cables are part of each components load circuit. The stud attachments are accessible by removing the 3 port and starboard panel screws. At this point the hinged door can be opened.

Periodically check the stud attachment nuts for tightness. Ensure that all battery switches are off before servicing these connection points.

*Note that the optional stabilizer (Seakeeper) component is wired directly and does not employ an attachment stud.*



## Battery Board Component Feed Stud Blocks/Harness Plugs (Continued)



On the other end of the battery board panel display is found a harness plug-in connector. It connects the sump wiring with the D. C. distribution panel which is mounted on the battery board.

Mounted at the bottom end of the battery board panel display is the main load feed for the amplifier system. Note that the 8 channel amplifier feeds through this stud attachment to drive the Fusion stereo high performance package option if installed.

The stud attachments are accessible by removing the 3 port and starboard panel screws. At this point the hinged door can be opened.

Periodically check the stud attachment nut for tightness. Ensure that all battery switches are off before servicing this connection point.

## Outboard Only- DC Junction Blocks

STBD. ENGINE DC CABLE  
JUNCTION BLOCK

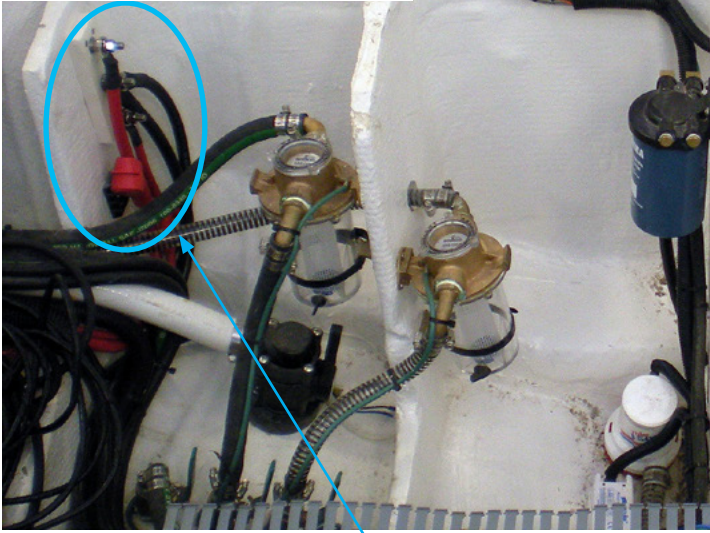

PORT ENGINE DC CABLE  
JUNCTION BLOCK

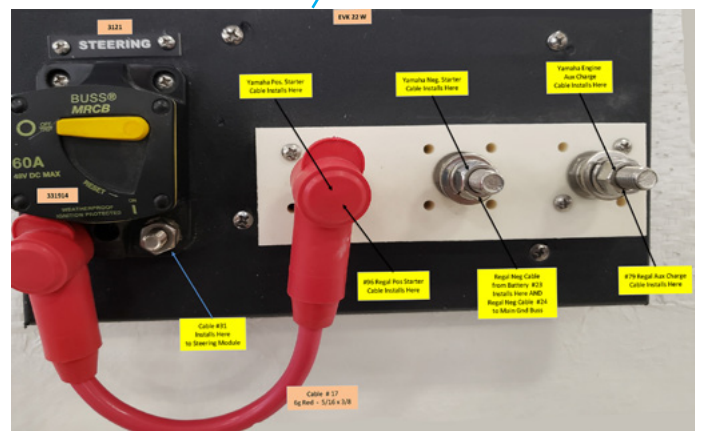
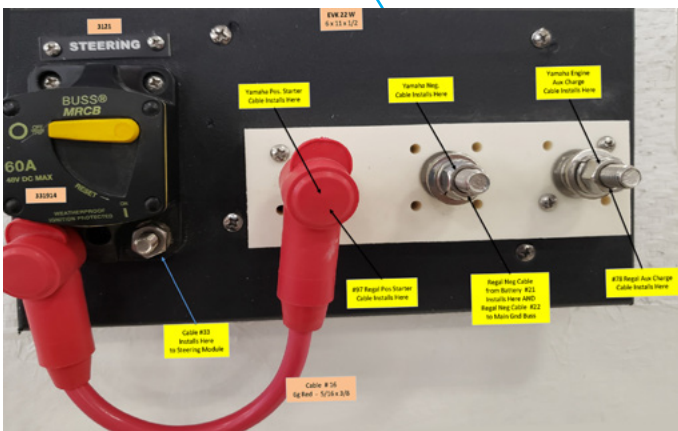
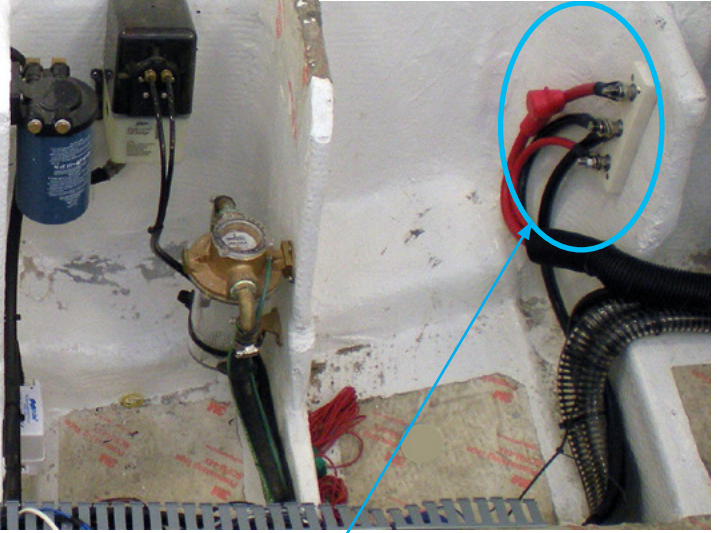

Note on outboard vessels there is a port and starboard engine sump mounted DC load junction stud block with battery feed and AUX. CHARGE leads.

Periodically check the nuts under red boots for tightness. See photo.

Ensure the positive red boots are reinstalled covering the stud completely. Note that the negative feed normally does not employ a boot as it is at ground potential.



## Battery Charger Overview

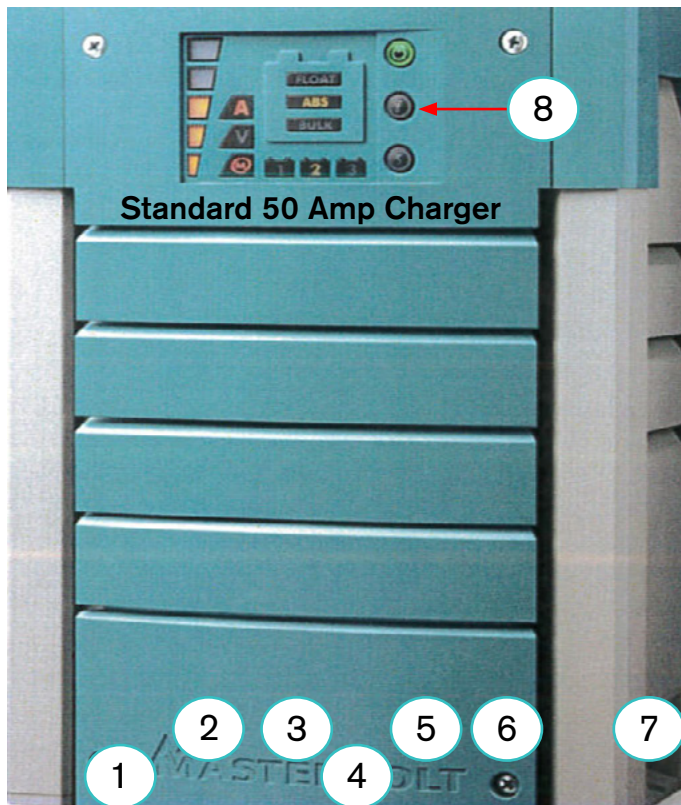

The standard 50 amp battery charger shown above with surrounding features:

*Note that there are 3 charger output lead studs available but only 2 output lead studs are used.*

1. Charger AC wiring connections-
2. Charger DC output wire 1 to house accessory battery.
3. Common DC negative wire output terminal.
4. Common ground connection (green).
5. Charger output wire 2 to house main battery.
6. Charger output wire 3 (not used).

7. Dip Switches are used to change battery types.

6. LED battery charger display panel.

The battery charger output leads are connected to a set of parallel link plates (tin plated copper) attached to the bottom of the remote battery switches. Being the plates are tied together current bleeds through the charging relays which feed each battery as needed. As battery voltage drops to 13.0 volts battery charging begins.

Review the battery charger output wire connections to the remote battery switch plate studs for further clarification found in the battery management panel wiring schematics a few pages back.

*For more detailed information on the standard battery charger operation refer to the battery charger operator's manual.*



### WARNING

SWITCHING THE CHARGEMASTER TO "STAND BY" DOES NOT CUT OFF THE CONNECTION TO THE BATTERIES OR THE AC SOURCE. VOLTAGES ARE STILL AVAILABLE INSIDE THE APPARATUS!



### WARNING

THE CHARGEMASTER IS NOT PROTECTED AGAINST REVERSING POLARITY OF THE DC OUTPUT OR 3 PHASE AC ON THE AC INPUT!



### WARNING

PREVENT INJURY, DEATH, OR PROPERTY DAMAGE FROM EXPLOSIVE GASES FOUND IN LEAD-ACID BATTERIES! VENTILATE AREA, AVOID SMOKING AND USING EQUIPMENT WITH BRUSHES.

## Typical Battery Charger Display

The standard 50 amp battery charger features a multi-color LED display. Different LED colors and combinations realize different meanings. Combination of the current display (A) with the load bar shows the percentage of maximum current of the three outputs up to three different battery banks including accessory house, house main, and engine cranking banks. Combination of (V) with the load bar shows the actual charging voltage.

### 3.3 DISPLAY

The Chargemaster is equipped with a multicolour LED display. Different LED colours and combinations have different meanings. Combination of the current display (A)

with the load bar shows the percentage of maximum current, of the three Battery banks together.

Combination of (V) with the load bar shows the actual charging voltage.

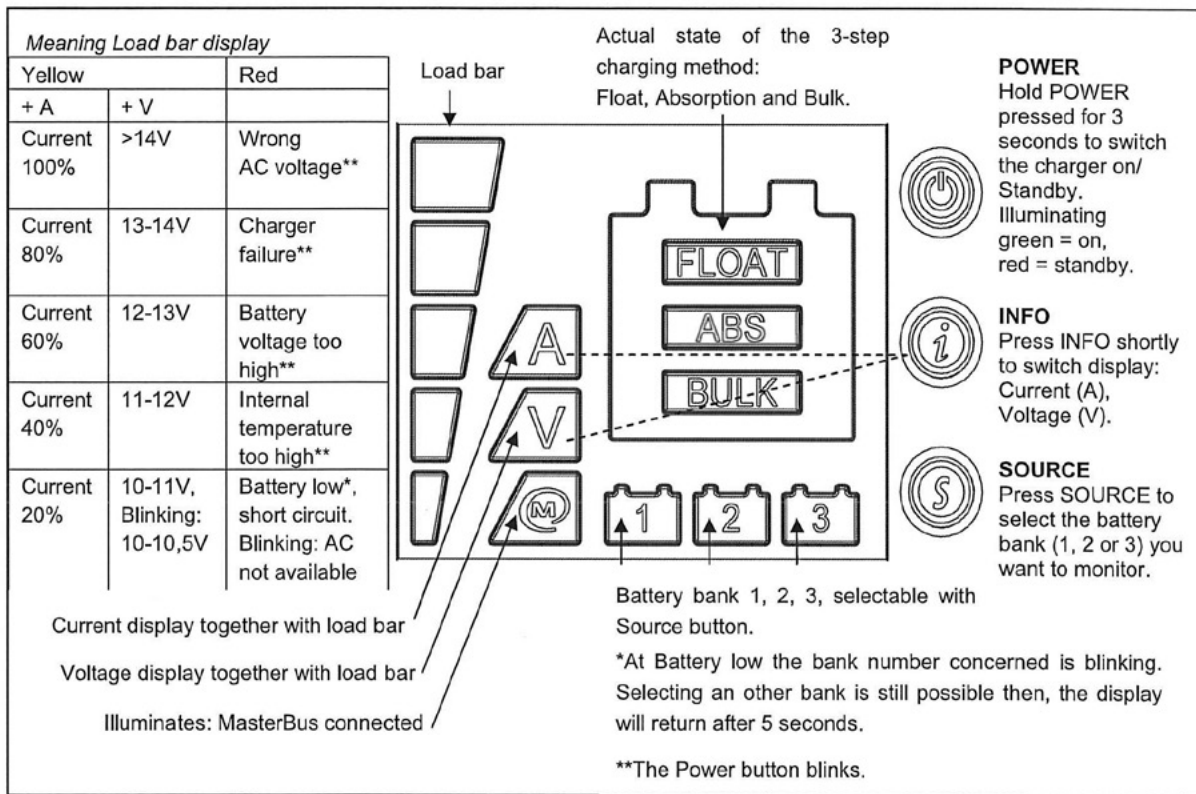
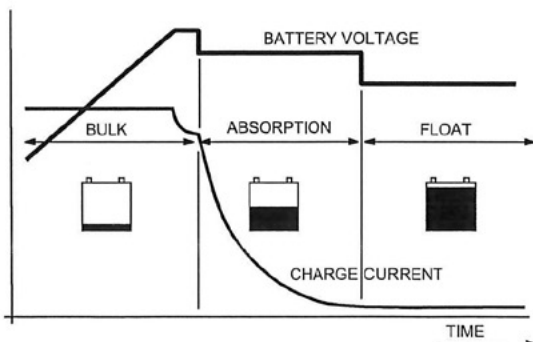

Figure 2: Display operation of the Chargemaster

### 3.4 THREE STEP CHARGE ALGORITHM



The first step of the three step Plus charge system is the BULK phase, in which the output current of the charger is 100%, and the greater part of the capacity of the battery is rapidly charged. The current charges the batteries and gradually the voltage rises to the absorption voltage of 14.4V (12V models) or 28.8V (24V models) at 25°C / 77°F. The duration of this phase depends on the ratio of battery to charger capacity, and also on the degree to which the batteries were discharged to begin with.

## Typical Battery Charger

The standard battery charger features 50 amp output and universal voltage for house and engine starting battery circuits. The charger operates between 95 and 277 volts. This is helpful on docks that carry lower voltage. The new electronic battery chargers are “smart”. It will charge the batteries in 3 stages; bulk, absorption, and float formats. The charger is designated to get the maximum life out of your batteries, using micro computer controlled charging.

It is recommended to keep the battery charger “on” at all times when AC power is available for maximum battery life. We recommend checking the battery electrolyte level weekly especially in warm temperature conditions.

Fill batteries to specified levels using only distilled water. The charger is factory set to charge flooded lead acid batteries which are the most common type available. The charger can be reprogrammed to take gel cell or AGM batteries.

In the event the boat is switched over to different battery designs, it is important that all batteries are of the same type.

Remember, changing to a different battery type requires re-programming the charger. Do not mix different designed batteries because they need different charging rates and voltages.

During bulk charge the battery charger brings up the battery charge state quickly, as the battery nears fully charged, it switches over to absorption charge. Absorption charges at a lower rate than bulk, until the battery is just a few % away from full charge.

The battery charger display includes functional LED information for charge current, charge voltage, charge phase (bulk, absorption, float), battery content measurement and/or battery condition measurement as a % of Ah capacity.

It is recommended that an ABYC certified electrical technician perform any repairs or service. Do not attempt to open the battery charger casing.

Refer to the vendor information in the owner’s information satchel for more detailed instructions.

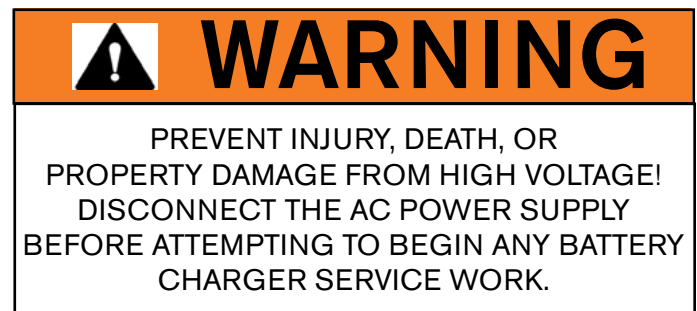



## 100 Amp Charger (Seakeeper Option Only)

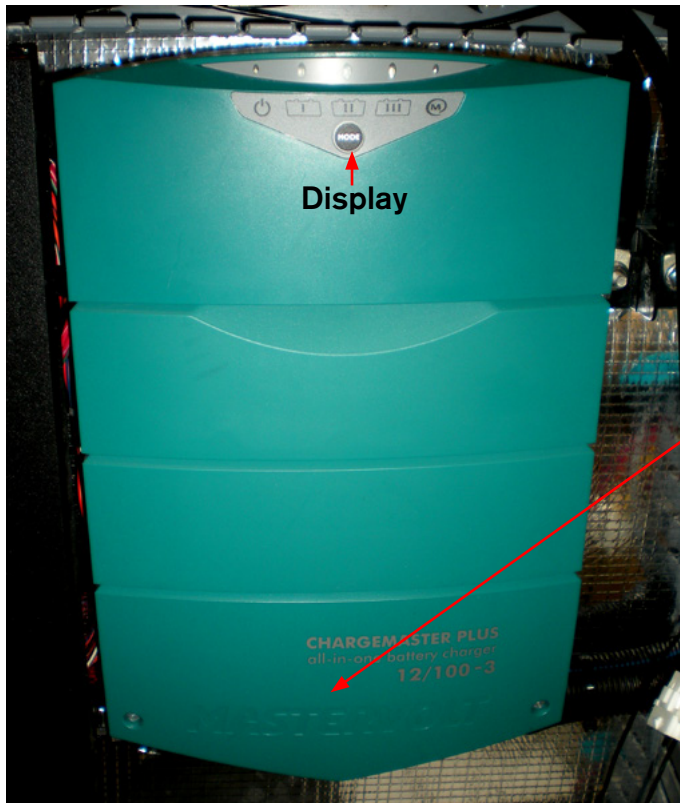

Overview of the connection compartment  
Front side with open connection compartment

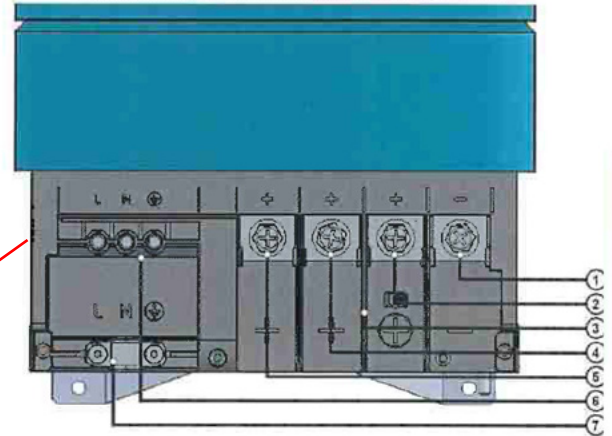

- 1 Common negative output terminal
- 2 Positive terminal charge output 3; DC 3 IN/OUT
- 3 Isolation walls for DC connections
- 4 Positive terminal charge output 2; DC 2 OUT
- 5 Positive terminal charge output 1; DC 1 OUT
- 6 Screw terminals AC input

When the (Seakeeper) stabilizer option is installed a 100 amp battery charger is standard to handle a higher equipment amperage draw. This battery charger is completely automatic. Under normal instances it can be left on with AC power and batteries connected. This charger supports acid-lead and select Li-ion type batteries such as Mastervolt MLI.

Regal recommends 2 Group 8D house batteries and 2 Group 31 engine starting batteries (one for each propulsion unit).

Note that both types of batteries may include maintenance free, low maintenance, AGM, gel or deep-cycle. When replacing batteries always do so in sets and check with your closest Regal yacht dealer for battery recommendations and specifications.

The battery charger connections are shown above with the front lower cover removed. The #4 connection delivers up to 100 amps of battery charging current to the accessory house battery. The #5 connection delivers up to 100 amps of battery charging current to the house main battery. The #2 connection is a "smart output" with amperage up to 40 amps on 12 volt systems. This connection is currently not used.

The battery charger output positive leads travel to a set of parallel link plates (tin plated copper) attached to the bottom of the remote battery switches. Since the plates are tied together current bleeds through at the charging relays which feed each battery as needed. As battery voltage drops to 13.0 volts battery charging begins. See the battery management panel wiring schematic on prior pages for battery charger circuit information.

## 100 Amp Battery Charger Switching On/Off

This particular battery is activated by pressing on the MODE button for about 3 seconds. The MODE LED will illuminate green. If AC power is activated and batteries are needing a charge the charging process will begin. Once switch on the charger automatically resumes operation like it was disconnected from an AC source temporarily.

If you hold the MODE button pressed again for about 3 seconds the battery charger will switch off; the battery stops and the MODE LED will illuminate a red color. When the battery charger is switched off it can only be reactivated by pressing the MODE button again.

 **WARNING**

SWITCHING THE BATTERY CHARGER OFF OR "STAND-BY" DOES NOT CUT OFF THE CONNECTION TO THE BATTERIES OR AC SOURCE. VOLTAGES ARE STILL PRESENT INSIDE THE BATTERY CHARGER COMPONENT.

## 100 Amp Battery Charger Status Display

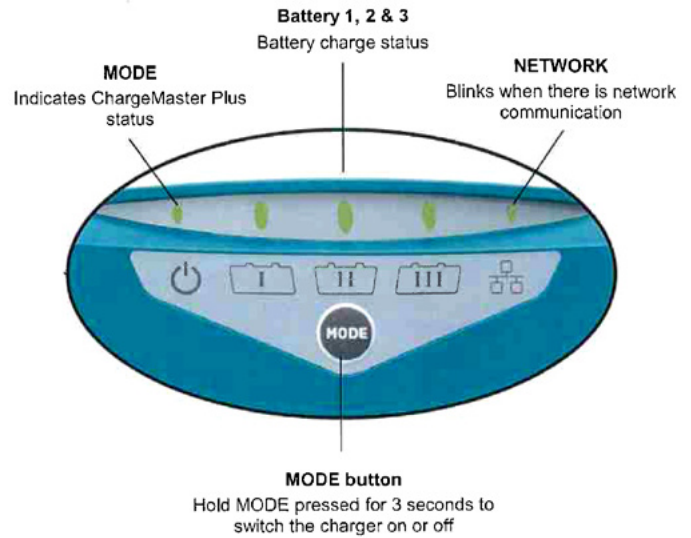

The status display shown above is located at the top of the 100 amp battery charger. The display enables you to control the charger and monitor the charging process.





On the following pages examples of the 3 level display menu are explained. The menu navigation is controlled by quickly pressing the MODE button. After each press the next menu is shown. Note the 3 menu levels of status, output power and error. Each level uses a LED color including green, orange, and red.

## 100 Amp Battery Charger Status Display Levels



The status display has a 3-level menu. Menu navigation is done by shortly pressing the MODE button. After each press the next menu level is shown. The MODE LED color indicates the level that is being shown.

Menu	MODE LED color	Meaning
Level 1	Green	Status menu
Level 2	Orange	Output power menu
Level 3	Red	Error menu



### Status

Display	LED	State	Meaning
	MODE	Solid green	ChargeMaster Plus on
		Solid red	ChargeMaster Plus stand-by
		Blink fast red	Error, navigate to error menu
	Battery I	Blinking fast green	Battery in bulk stage
		Blinking slow green	Battery absorption stage
		Solid green	Battery in float stage
	Battery II	Blinking fast green	Battery in bulk stage
		Blinking slow green	Battery absorption stage
		Solid green	Battery in float stage
	Battery III	Blinking fast green	Battery in bulk stage
		Blinking slow green	Battery absorption stage
		Solid green	Battery in float stage
	Network	Blinking green	Network communication

### Output power

Display	LED	State	Meaning
	MODE	Solid orange	Output power menu
	Battery I	Solid orange	Total output power 0-25%
	Battery II	Solid orange	Total output power 26-50%
	Battery III	Solid orange	Total output power 51-75%
	MasterBus	Solid orange	Total output power 76-100%

### Error

Error	LED	State	Meaning	What to do
	MODE	Blink fast red	Error menu	
	Battery I	Blink fast red	Reverse polarity	Check battery connection
	Battery II	Blink fast red	AC error	Check AC voltage/frequency
	Battery III	Blink fast red	DC error	Check battery voltage
	MasterBus	Blink fast red	Temperature sense error	Check temperature sensor

## Typical Charging System- Summary Notes

Following are a few notes regarding the charging system or specific charging system components.

1. With the battery charger unplugged from shore power the battery charger is not generating any DC power. However, the battery charger is connected to the batteries through the remote battery switches and charger breakers which are located on the battery board. The charger breakers would stop any short in the wires that run directly to the battery charger. Remember that the charger is connected to the battery side of the switch and is continuously "hot".

2. There is a breaker protecting the battery charger circuit. A primary cause of the breaker to "trip" would be if the positive and negative battery cables were crossed. The above situation could easily happen if someone was trying to start a battery with "jumper cables." To a lesser degree should a wire delivering current from the battery charger chafe a fuse may "blow" and the battery charger would cease its charging operation. See your Regal dealer for ordering extra fuses for your charger.

3. If one of the engine cranking batteries is weak or "dead" and the engine will not crank first start the generator up and let it run awhile as it will send an initial charge to the weak battery.

Of course you can press the engine parallel button on the battery activation panel.

4. Always turn the battery switches on the battery activation panel to the "off" position when leaving the vessel for extended periods. Select breakers that control specific safety functions of the boat will operate as normal even with the battery switches off such as the automatic bilge pumps and stereo memory circuits.

5. When leaving the vessel after connecting your dock side power cord turn the battery charger breaker at the main ship's panel to the "on" position. This will permit the battery charging system to energize the appropriate batteries as needed.







































6. Remember the appropriate engine will not crank over if the remote battery switch in the "off" or straight out position.

7. An internal battery charger fuse protects the entire circuitry from reverse connections. For example, if someone was attempting to "jump" start an engine and had the polarity reversed on the jumper cables this action may cause the internal fuse to "blow" thus making the charger inoperative.

Bottom line- always remove a battery from the if using a trickle charger. Do not jump start engines using booster or jumper cables attached to batteries located in the bilge since sparks could ignite from battery or fuel vapors.



## DC Helm Breaker Panel (Typical)

 HORN	 SPOT LT	 TRIM TABS	 NAV LTS	 HATCH LIFT	 SEAT SLIDE	 PLOTTER 1	 VHF RADIO
 BLOWER 1	 USB / 12V OUTLET	 FWD BILGE PUMP	 AFT BILGE PUMP	 WIPER STBD	 SUN ROOF	 PLOTTER 2	 RADAR
 BLOWER 2	 POWER PLATFORM	 WIRELESS CHARGER	 WINDLASS PERMIT	 AIR COND VENT	 COCKPIT TV ACTUATOR	 VIDEO CAMERA	 ELECT / NMEA
 DECK LTS	 UNDER WTR LTS	 HARD TOP LTS / PATIO LTS	 BILGE LTS	 REFRIGERATOR PORT	 REFRIGERATOR STBD	 SALON WINDOW	 ACCY 1
 GAS VAPOR DET	 HALON	 HELM SEAT 1	 HELM SEAT 2	 STOVE LIMIT SWITCH	 ACCY 2	 BACK LIGHT	

*Note that select breakers protect optional equipment that may not be installed on your vessel.*

### Horn

This breaker protects dual trumpet horn located on the hardtop.

### Spot Lt

This breaker protects the remote control spotlight

### Trim Tabs

This breaker protects the trim tab motor located in the bilge compartment.

### Nav Lts

This breaker protects the navigation light system.

### Hatch Lift

This breaker protects the hatch lift actuator circuit.

### Seat Slide

This breaker protects the seat slider motor circuits.

### Fresh Water Pump

This breaker protects the potable fresh water pump located under the forward cabin floor locker.

### Plotter 1

This breaker protects the helm mounted port Garmin plotter. Push on-Pull off style breaker.

### VHF Radio

This breaker protects the Garmin marine radio.



## Helm Breaker Panel (Continued)

### Blower 1

This breaker protects the powered ventilation blower motor circuit.

### USB/12 Volt Outlet

This breaker protects a number of phone charging stations and the 12 volt accessory plug.

### FWD Bilge Pump

This breaker protects the forward cabin located bilge pump circuitry.

### Aft Bilge Pump

This breaker protects the bilge pump located in the aft bilge.

### Wiper Stbd.

This breaker protects the starboard mounted windshield wiper circuit.

### Sun Roof

This breaker protects the sliding sun roof motor actuator mounted on the hard top.

### Plotter 2

This breaker protects the helm mounted stbd. Garmin plotter.

### Radar

This breaker protects the Garmin HD closed array radar mounted on the hard top.

### Blower 2

This breaker protects the powered ventilation blower motor circuit.

### Power Platform

This breaker protects the platform lift motor mechanism. Note this option is not available on the 36 outboard vessel.

### Wireless Charger

This breaker protects the phone charger built into the starboard helm arm rest.

### Windlass Permit

This breaker protects the anchor windlass switch at the helm which actuates the circuit.

### Air Cond Vent

This breaker protects the ventilation motor used to cool the helm area.

### Cockpit TV Actuator

This breaker protects the TV actuator motor which raises and lowers the cockpit television from the hard top.

## Helm Breaker Panel (Continued)

### Video Camera

This breaker protects the FLIR infrared camera system for nighttime navigation.

### Elect/NMEA

This breaker protects the NMEA 2000 communication circuit electronics.

### Deck Lts

This breaker protects the deck courtesy lighting.

### Under WTR Lts

This breaker protects the transom/hull mounted blue underwater lights.

### Hardtop Lts/Patio Lts

This breaker protects the cockpit patio and hard top mounted lighting circuits.

### Bilge Lts

This breaker protects the LED engine room lights.

### Refrigerator Port

This breaker protects a cockpit port mounted refrigerator circuit.

### Refrigerator STBD

This breaker protects a cockpit starboard mounted refrigerator or ice maker circuit.

### Salon Window

This breaker protects the opening and closing window motor circuits

### ACCY 1

This breaker protects after market components installed. Do not exceed breaker amperage limit.

### Gas Vapor Detector

This breaker protects the gas vapor system circuitry.

### Halon

This breaker protects the automatic fire extinguisher system helm mounted gauge circuitry.

### Helm Seat 1 & 2

These breakers protect the salon helm/passenger seat actuator switch circuitry.

### Stove Limit Switch

This breaker protects the salon stove circuitry.

### ACCY 2

This breaker protects after market components installed. Do not exceed breaker amperage limit.

### Back Light

This breaker protects helm instrumentation lights.

## Typical On-Board Lighting System

The on-board lighting system features a variety of fixtures in the cabin, cockpit and deck areas. Their source of power is 12 volt direct current.

There are a variety of fixtures with most featuring LED technology (Light Emitting Diode). LED lighting works by passing electrical current through a microchip, which illuminates the tiny light sources called LED's and the result is visible light.

To prevent performance issues, the heat LED's produce is absorbed through a heat sink. LED's are more efficient, versatile and last longer. Since there is no "filament" they are cool to the touch which makes them safer around children too. LED's are available in bright white, soft white and daylight types. Types are dependent on room requirements. For example, soft whites are used in galley areas where light rays are absorbed by the counter tops, etc. The amount of LED light is measured in lumens verses watts which is used to measure older incandescent type bulbs.

Bottom line with LED's on board there are no light bulbs to change along with extended service, low amperage draw, and coolness when touched! Depending on which semiconductor is used its crystal structure produces a defined wavelength in the ultraviolet range of light.

Regarding the blue LED lights on board your vessel the semiconductor used is gallium nitride with a Wurtzite crystal structure and a direct bandgap of 3.4 eV, which corresponds to the wave length of light in the ultraviolet range. Blue LED's are the most difficult to produce.

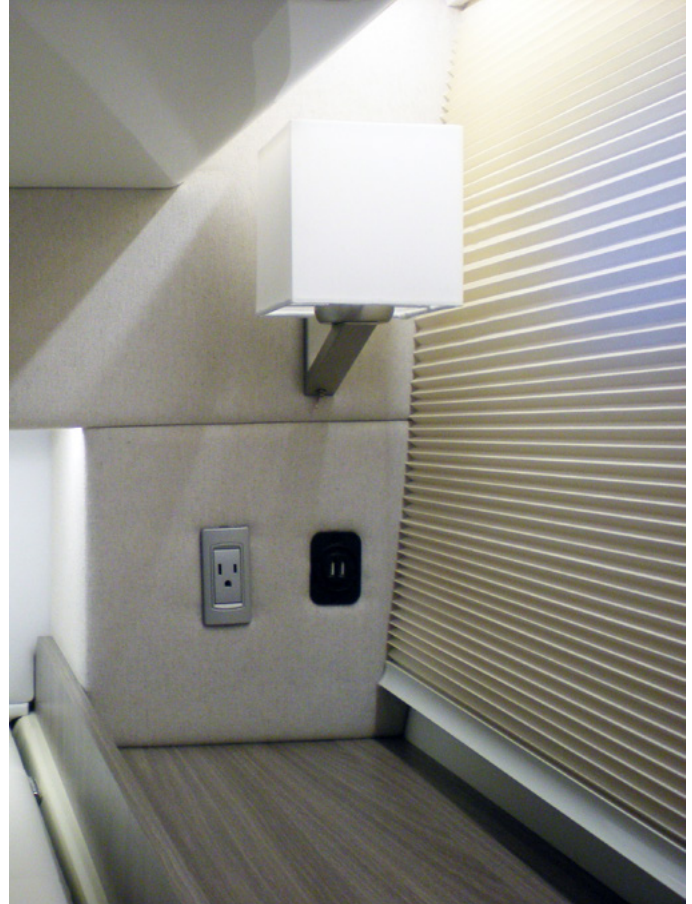

## Typical On-Board Switch Panels & Functions

There are a number of switch panels on board. We will cover the function of each switch and display its location on the vessel.

*Note that switch panel location and component function can change at any time as Regal is constantly improving each model during its production life cycle.*

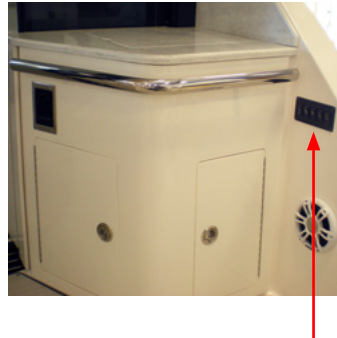

This 5 switch panel is located aft of the galley panel on the coaming panel. Note the blue load bar lit when switch is activated.



This switch operates the cockpit passenger seat. It controls moving the seat up or down.



This switch controls the aft patio seat back and forth movement. Moving the seat completely aft will increase the available patio space. The switch is located within easy reach on the port coaming.

**Hatch-** This switch controls the opening and closing of the engine hatch on stern drive vessels and the Lazarette storage area on outboard models. Make sure the floor area is free of objects and people before activating the switch.

**Bilge Lts-** This switch controls the engine room lights on stern drive models and the Lazarette storage area on outboard models. All lights are DC and of the LED type.

**Patio Lts-** This switch controls the lights integrated into the patio overhead portion of the hard top.

**Under Water Lights-** This switch controls the transom and aft hull side LED under water lights.

**Cockpit lights-** This switch controls the LED blue cockpit lights. They provide a safe passageway on board during evening hours.



## Typical On-Board Switch Panels & Functions



**Air Cond-** This switch controls a booster fan connected to the A/C ducting system. When activated there is increased cool air emitting from the galley A/C vent next to the switch panel.

**TV Lift-** This switch controls the cockpit television integrated above the galley cabinet in a hard top ceiling locker. When the down portion of the switch is activated the television moves down to view. When the up portion of the switch is activated the television moves up into the hard top ceiling.

**HTop Lts-** This switch controls the cockpit overhead LED lights.

**Salon Window-** This switch controls the up and down motion of the cockpit salon window. Note that the salon window is optional and is part of the salon door package.

There are several convenient phone charger outlets located on board the vessel housing USB plugs. Locations may be the forward berth, mid berth, helm, cockpit, forward deck and patio. Make sure the protective covers are reinstalled after use.



## AC Electrical System

### Overview

Alternating current referred to as AC current is brought on board through the use of dock-side (shore power) cords or produced on board through the generator. Just as a residential home uses 120/240 volts to run various household appliances and equipment the same holds true on your vessel.

With AC current electrons “cycle” in one direction a short distance and reverse themselves traveling in the opposite direction. This is how AC became known as alternating current. The rate that the current reverses itself is referred to as frequency. In the United States the alternating current frequency is 60 cycles per second. Overseas a 50 cycle frequency per second is standard. Component specifications must match the country's frequency.

### Basic Electric Terms

Voltage is a measurement of the electrical potential that an electrical power source contains for doing some type of work for us. Think of it as electrical pressure. An example might be your boat's battery.

Amperage is a particular amount of electricity flowing through some part of a circuit. Think of it as the rate of electrical flow through your boat's wiring.

Resistance is measured in ohms and inhibits the electrical flow through a circuit. An example would possibly be an incandescent light bulb. The resistance in the light bulb element allows it to glow and brighten the cabin along with giving off heat.

It is important that you understand and respect the alternating current system used on board. Be sure to read and follow any danger, warning, or caution labels in reference to the yacht's electrical system or individual equipment components. Most of all, use common sense!

### Dockside Cord Usage

The dock side cord is the basic component used to deliver dual 30 amp service from the marina dock power box to the vessel itself. Before plugging in the dock side power cord check to see that all vessel AC breakers are off. This includes the incoming as well as both the main and equipment breakers at the AC ship's control panel. See the AC panel illustration later in this chapter.

When connecting the shore power cord be sure to twist the cord into the marina inlet plug. This motion will lock the plug in the socket.

There may be several types of inlet plugs located at the marina dock power center. Be advised that the 30 amp plug is much smaller looking and the 50 amp cord will not physically fit it.

Also, marina dock power centers normally have breakers that must be activated after installing the dock side cord. Make sure the dock side cord has enough slack to weather changing tides if applicable and at the same time does not come in contact with the water. Check with the marina dock master for more information on their shore power operation and requirements.

## Dock Side Cord Usage Continued

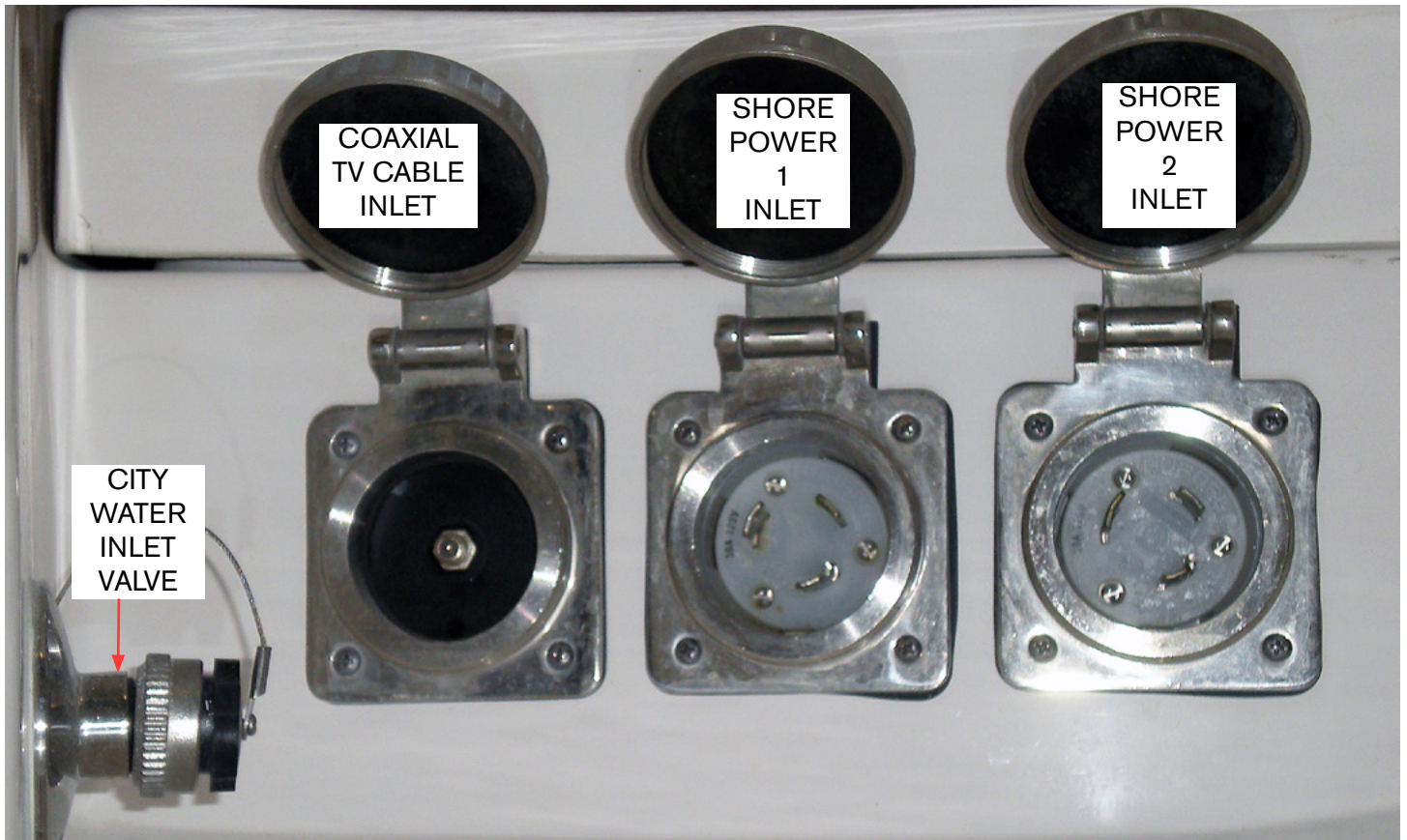

Read and understand the shore power warning label below. As needed make tidal adjustments for shore power cords to ensure they do not dangle and are not immersed in water while being used.

Before disconnecting the shore power cord ensure that all AC equipment breakers are off at the cabin master AC panel to prevent component failure.

When disconnecting the shore power cord first turn the breaker to the "off" position at the marina dock power center. Then remove the dock side cord from the marina outlet.

### **WARNING**

Electrical shock and fire hazard. Failure to follow these instructions may result in injury or death.

- (1) Turn off the boat's shore power connection switch before connecting or disconnecting the shore power cable.
- (2) Connect the shore power cable to the boat first.
- (3) If polarity-warning indicator is activated, immediately disconnect cable.
- (4) Disconnect shore power cable at shore outlet first.
- (5) Close shore power inlet cover tightly.

**DO NOT ALTER SHORE POWER CABLE CONNECTORS**



## **DANGER**

**PREVENT BODILY INJURY, DEATH OR FIRE!  
NEVER USE EXTENSION CORDS  
OR IMPROVISED CORDS  
IN SHORE POWER/MARINA INLETS.  
USE ONLY APPROVED MARINE  
SHORE POWER CORDS  
MATCHING THE ORIGINAL  
WIRE GAUGE AND AMPERAGE.**



## Dock Side Cord Usage Continued

Typical 30 amp domestic shore power cords (dock side cords) contain the following wires:

- Black-ungrounded conductor containing 120 volts
- White-neutral ungrounded conductor
- Green-grounding conductor

Before plugging in the dock side power cord check to see that all vessel AC breakers are off. This includes the incoming as well as both the main and equipment breakers at the AC ship's control panel. See the AC panel illustration later in this chapter.

BOAT INLET  
PLUG IN END



TYPICAL 30 AMP CORD

When connecting the shore power cord be sure to install the cord into the boat inlet plug first. The inlet plugs are located on the port deck. Note the shore

power 1 and 2 power inlets which feed the ship's AC panel 1 & 2 main breakers. The cord installs one way only. Align the 2 pins with the 90 degree shape, (or use the imprinted arrows and detentes located on the inlet plug) insert the cord end straight into the inlet plug and twist in a clockwise direction to lock in place. Screw the threaded sealing ring into the shore power inlet until tight. This protects the inlet and cord pins from moisture and possible corrosion build-up. Repeat procedure with other 30 amp cord. When not in use close and turn the covers on the shore power inlets until tight to prevent moisture from entering the plug.



TYPICAL MARINA  
SHORE POWER  
STATION

Tips- Marina Shore Power Stations

As you become a more experienced boater you may engage in longer cruises with over night stays. It is most frustrating after a day of hard boating to pull into a marina and find your shore power cord does not adapt to the marina shore power station. This may be especially true stopping at older marinas built before the 1978 National Electric Code was enacted for these facilities. Therefore, it is recommended that you

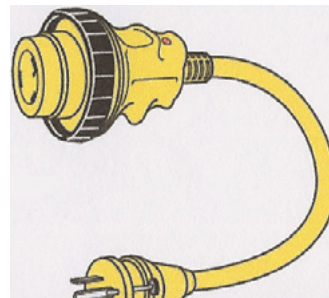

TYPICAL SHORE  
POWER STRAIGHT  
ADAPTER CORD

purchase several shore power adapter cords to meet various marina plug footprints.

Carry a couple extra 125 volt/15 amp adapters with a female twist 3 prong plug to a straight blade male plug with a locking screw.

A point to remember is that sometimes a chart plotter will provide local cruising information including marinas and facilities they offer but normally they do not provide the power voltage available at dock side.



## Shore Power Possible Problems/Solutions



1. After the dock side cord is hooked up to the marina dock power center and the AC ship's panel main breaker for shore power 1 or 2 is activated no voltage is shown on the main panel AC volt meter.

Check the breaker on the marina dock power center to ensure it is activated.

Check the ELCI breaker/voltage sensing device. The "power" icon should show green. If a leakage fault exists a "red" icon will light indicating the breaker is "tripped". If needed, use the test button to reset the breaker. Read the information in the following pages regarding ELCI system.

2. The marina dock power center lacks a 30 amp twist plug inlet.

Call the dock master or marina personnel. An adapter cord may be available from the dockage facility. **NEVER IMPROVISE ANY TYPE OF CORD OR POWER INLET CHANGES!**

Additional cord adapters can be found at retail boating outlets.



## WARNING

PREVENT SEVERE INJURY OR DEATH!  
ALTERNATING CURRENT (AC) CAN KILL YOU!  
DISCONNECT  
ALL ELECTRICAL POWER SOURCES  
BEFORE ATTEMPTING TO REPAIR OR REPLACE  
ANY ELECTRICAL COMPONENTS.

## ELCI (Equipment Leakage Circuit Interrupter)

### Introduction-The Need For ELCI's

Once the shore power cords are attached to the marina dock side power, the vessel dock side power inlets and the circuit is activated voltage travels to the ELCI actuator enclosure which is located in the port aft bilge (sump) for access/monitoring.

Once through the ELCI power continues to the ship's main AC control panel culminating at the shore power main. Finally, components are activated using the auxiliary equipment breakers.

Note that both shore line breakers above are of a single throw double pole design. Both EFCI breakers feature leakage fault technology. If the 30 amp ELCI breaker "trips" find the cause of the problem before resetting the breaker.

ELCI stands for "Equipment Leakage Circuit Interrupter". There are two potential failures in a boat's electrical system that can put people on or around a vessel at risk of lethal electrical shock. In a properly functioning marine electrical system, the same amount of AC current flows in the hot and neutral wires.

However, should electricity "leak" from this intended path in these two wires to ground, this condition is referred to as a "ground fault". An example of this is an insulation failure in the wiring of an appliance.

Furthermore, a ground fault can occur when the grounding path is broke through a loose connection or broken wire. As an example a shore power ground wire may fail due to fatigue caused by constant motion and stress. Faulty grounds can go undetected; a simple continuity test may not reveal problems.

When these 2 conditions occur at the same time, it may produce tragic results. The combination of a "ground fault" and a faulty ground could result in the metal parts of the vessel and underwater gear to become energized. If this condition exists, besides being a hazard to personnel on board there is increased danger to swimmers near the boat. The result could be shocking people on board and swimmers could receive a paralyzing dose of electricity and drown due to loss of muscle control.

## ELCI (Equipment Leakage Circuit Interrupter)(Typical)

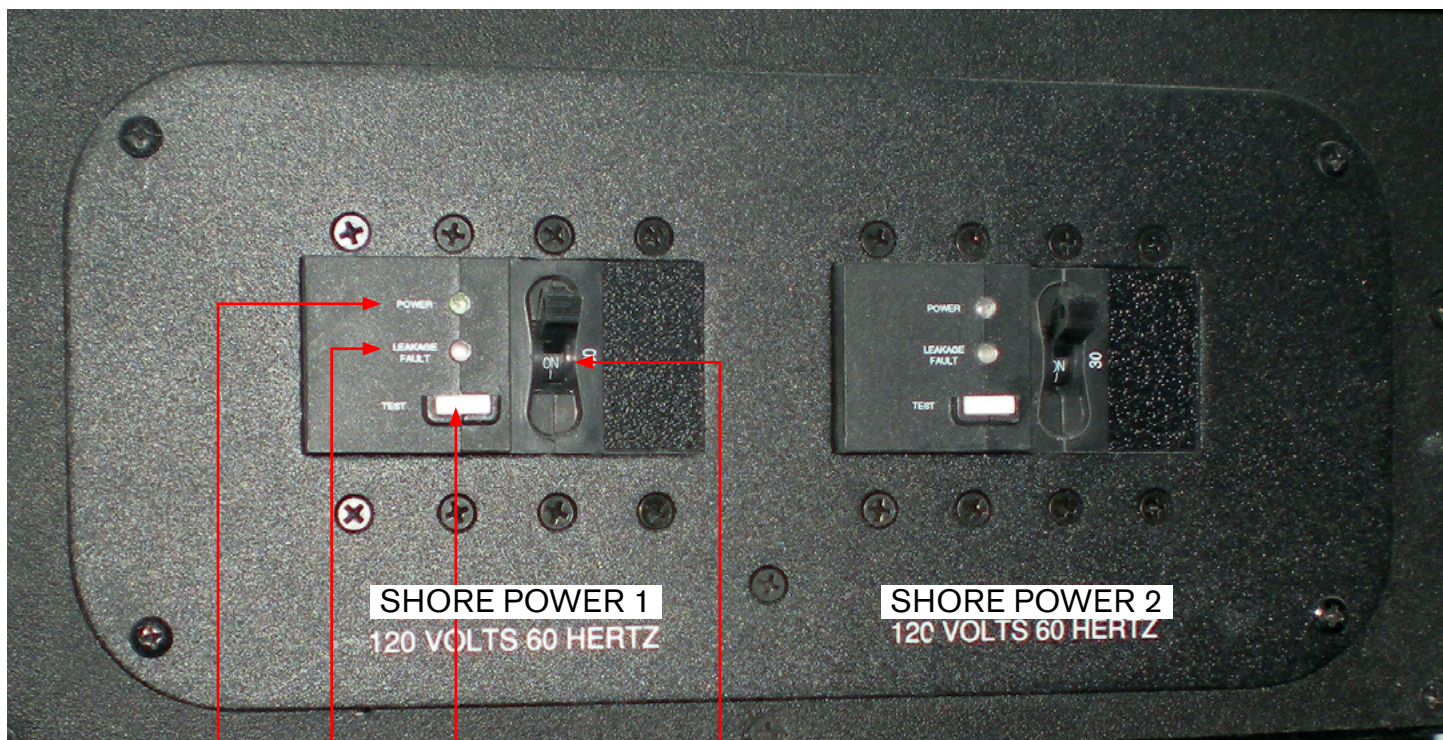

POWER  
LIGHT  
(GREEN)

LEAKAGE  
FAULT  
LIGHT  
(RED)

TEST  
BUTTON

ELCI  
BREAKER  
(30 AMP)

*Note that shore power 1 and shore power 2 parts description and operation are the same. Shore power 1 is used for illustration purposes.*

An ELCI system provides protection for the entire boat and features a trip threshold which enables ground fault protection for the entire shore power system beyond the ELCI.

The ELCI protection on individual shore power lines combined with GFCI'S will reduce the risk to those on the boat, dock, and in the water surrounding the vessel.

Notice that one ELCI breaker is marked shore power 1 and the other ELCI breaker shore power 2.

Another feature of the ELCI is a "leakage fault" detector located near the ELCI breaker itself. The leakage fault feature detects a change in the neutral wire current.

## ELCI System Continued

Should the current change more than 30 Ma or about 1/3 of an amp the unit senses the difference and will “trip” the breaker causing the leakage fault LED to illuminate red. This clearly indicates that the trip occurred as a result of leakage. Before resetting the ELCI breaker determine the cause of the leakage fault.

A proper operating alternating current system will display a green illuminated LED at the “power” marked area of the ELCI.

Periodically test the ELCI by depressing the “test” button. The breaker should “trip” indicating the system is functioning properly. Simply reset the breaker. The leakage hazard helps prevent serious equipment damage and possible fire.

After the neutral and the 2-120 volt conductors exit the ELCI they run directly to the ship’s main AC control panel.

The ELCI can at times undergo a process called “nuisance tripping” which can cause a “tripped” breaker. This can be caused by overloads in the electrical draw or sometimes caused from unbalanced loads. One way to minimize the situation should it occur is to monitor closer the energized devices on the vessel which will assist in keeping the total amperage used to a minimum and the loads between panel legs more balanced.

## ELCI Leakage Fault Detector LED SelfTests

As a central segment of the ELCI system there are two LED lights with a “test” button located at the shore power inlet. With the breaker in the ‘on’ position and the shore power cord hooked up these LED lights may show variations in color to provide system conditions.

They are:

### 1. Green LED On- Red LED Off

Line voltage is present, the breaker is closed, and the device is protecting the circuits against over current and leakage current.

### 2. Green LED Off, Red LED On

The device has detected leakage current and has opened the circuit breaker.

### 3. Green LED flashing, Red LED Off

The circuit breaker has opened due to over current or has been manually turned to the “off” position.

### 4. Green LED Off, Red LED Off

Line voltage is not present. Check cord connections and marina breaker for “on” position.

Note: Check circuit at least monthly by pushing in the switch marked TEST. When depressed, the breaker should return to the reset position indicating the ELCI circuit is operating properly.

For further information on the ELCI refer to the Carling web-site. *Note that both shore power 1 and 2 use the same testing procedure.*



# AC Ship's Panel (Typical)

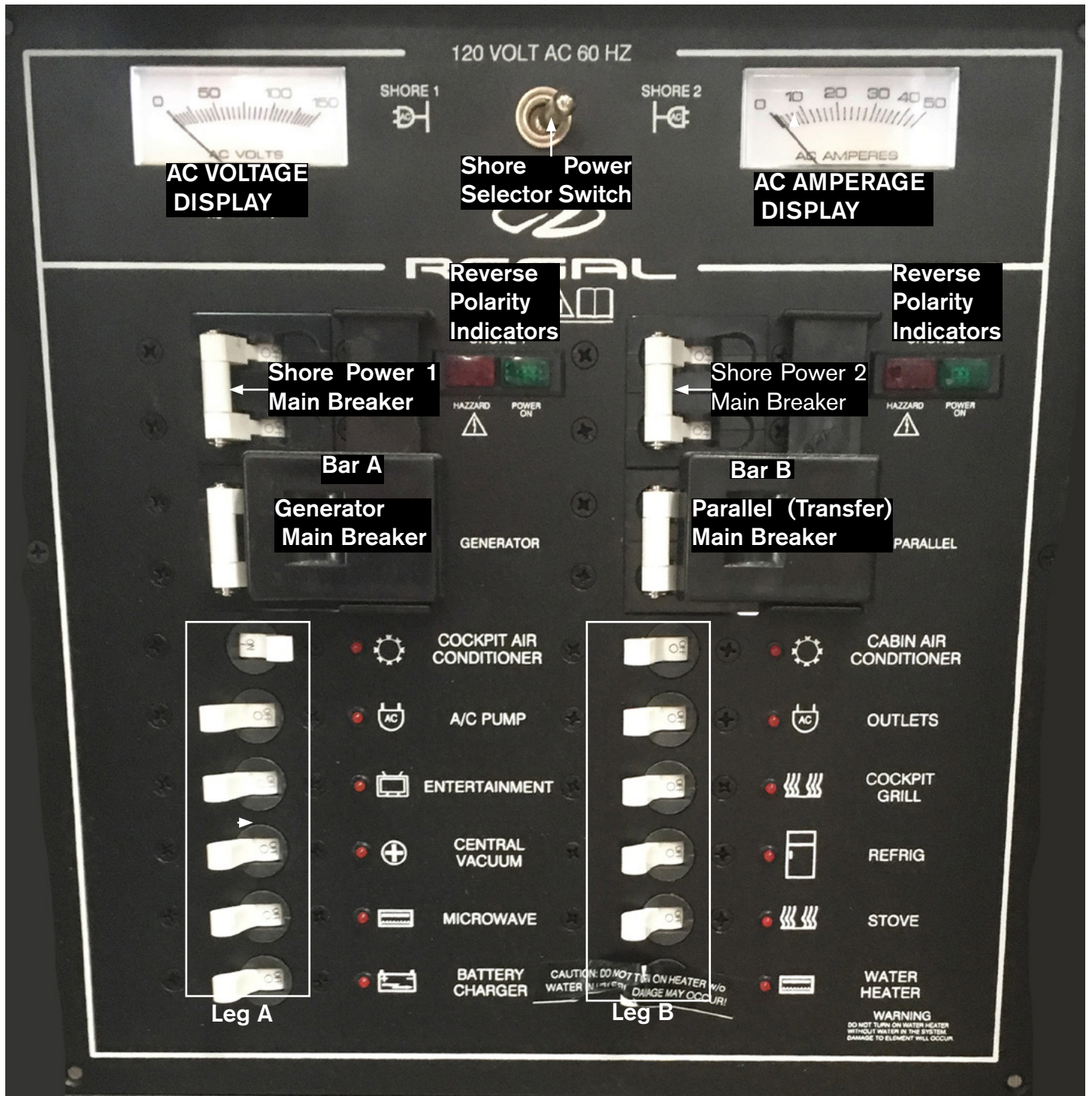

## AC Ship's Panel Continued

The typical AC (alternating current) ship's panel controls all high voltage components on your vessel. This panel is 120 volts AC on twin legs. Equipment is controlled by individual breakers. Voltage is supplied by either a shore power cord (moored) or by generator (at sea) if installed. The panel features voltage and current displays.

We will discuss each major feature. Refer to the photo on the previous page to enhance each component reviewed.

### Reverse Polarity Indicator

Before activating a 30 amp shore 1 or 2 breaker visually check for a green light at the reverse polarity indicator. The green light indicates there is no reverse polarity. If a red light appears on the reverse polarity indicator a hot wire and ground are probably reversed somewhere in the circuit from the dock to the main panel.

In all cases do not activate the main inlet breaker. Take immediate corrective action to find the cause of the reverse polarity situation. At this point, disconnect the shore power cord from the marina power center and call for professional assistance.

### 30 Amp Main AC Panel Shore power Breakers

As mentioned earlier, there are two main shore power breakers on the panel labeled shore 1 and shore 2. These single throw, double pole main breakers control power to that side of the panel and when activated deliver electricity through a system of sub breakers to the entire boat through dedicated legs of the panel. Before you energize the main breaker make sure all sub breakers are deactivated.

This prevents any excessive equipment motor draws and may eliminate any system arcing.

With the reverse polarity indicator displaying the green icon, activate shore breaker 1 by flipping the single throw arm to the on position. AC electricity now is distributed to that leg of the panel.

On the shore power 2 main breaker after bar B is moved down pull the transfer switch to the left which will allow shore 2 breaker to be activated. Now the entire panel is powered up.

At this point turn on sub breakers as needed always being conscious of the load current meter.

### 50 Amp AC Generator Breaker

When the vessel is under generator power at sea AC electricity is distributed through the 50 amp main generator breaker located on the AC main ship's panel beside the main breaker. See the previous illustration and the generator section for further information. Before activating the generator AC breaker it is recommended to make sure all equipment breakers are "off."

After starting the generator activate shore 1 breaker. Then push Bar A on the generator portion of the panel up and then activate the generator breaker. With the generator running activate shore 2 by flipping the shore 2 breaker to the on position. Move the bar up and flip the transfer switch to the "on" position which will direct current to shore 2 main and sub breakers.

## AC Ship's Panel Continued

### Line Voltage/Current Meters

After the shore power 30 amp main breaker or generator 50 amp breaker is activated line voltage will display on the the main panel.

As sub panel equipment breakers are activated the load current meter (extreme right side of panel) will show an amperage draw. Normally the amperage will ascend as more equipment breakers are activated and will descend as equipment breakers are deactivated.

### Shore Power 1 & 2 Switch

The 120 volt shore power 1/2 switch is located between the line voltage and load current meters. With the shore power switch in the "center" position it is off. When the shore power switch is toggled to the left the line voltage meter will display up to 120 volts available at Shore 1. As equipment breakers are activated the load current (amperage) meter will ascend and descend as equipment breakers are deactivated.

When the shore power switch is toggled to the right the line voltage meter will display up to 120 volts available at Shore 2. As equipment breakers are activated the load current (amperage) meter will ascend and descend as equipment breakers are deactivated.

The shore power 1 & 2 switch shows present usage equipment amperage can be a great tool for balancing loads between panel legs. This will help prevent circuit and panel overloads, power surging, and voltage drops.

As a general note on equipment breakers when leaving the yacht it is recommended that most breakers be turned off. It may be necessary if items are left in the refrigerator to leave the shore power cords hooked up and the battery charger on during extended periods along with the cockpit DC refrigerator since the charger keeps the batteries up.

## AC Ship's Panel Continued

### 120 Volt Main Panel Breaker Description (Typical)

#### Leg A

Cockpit Air Conditioner- This 20 amp breaker controls the cockpit air conditioner.

AC Pump- This breaker controls the air conditioning pump relay system which activates the a/c pump to send sea water through the air conditioning system.

Entertainment- This 10 amp breaker controls the HDMI circuit and if installed the cabin/cockpit television. Also, the receiver portion of the optional satellite television is controlled by this breaker.

Central Vacuum- This breaker controls the motor which drives the vacuum housed in the front berth area.

Microwave- This breaker controls the microwave installed in the mid cabin port side area.

Battery Charger- This 20 amp breaker controls the battery charger located in the bilge. It is recommended that when leaving the boat for extended periods this breaker be left energized in order to keep the ship's batteries in a charged condition (dock side cord must be hooked up).

#### Leg B

Cabin Air Conditioner- This 20 amp breaker controls the cabin air conditioning unit.

Aft Outlets- This 15 amp breaker controls the 120 volt GFCI type outlet and all outlets downstream.

Cockpit Grill- This 20 amp breaker controls the cockpit electric grill.

Refrigerator- This 15 amp breaker controls the 120 volt/12 volt cockpit refrigerator.

Stove- This breaker controls the cockpit stove.

Water Heater- This 15 amp breaker protects the hot water heater installed in the engine room/Lazarette compartment. Note to never activate an empty water heater as the element (component that heats the water within the water heater tank) will be damaged.



## **GFCI Outlet (Ground Fault Circuit Interrupter)**

Sometimes current in a circuit escapes its normal route and finds a “ground fault”. If that vehicle ends up to be your body and the current passes through your heart the results could be deadly. The outlet contacts close between 4 and 6 milliamperes.

A ground fault interrupter or GFCI senses the difference between the hot and neutral wire current before a fatal dose can be conducted and in a fraction of a second cuts the current.

The GFCI devices used in homes are normally not ignition protected and of the 15 or 20 amp variety. Your boat uses a 20 amp GFCI. By using a GFCI as the first receptacle in the circuit all the receptacles down stream on the same circuit are protected by the initial GFCI. This is accomplished by attaching the lhot wires to the line terminal of the GFCI receptacle and the out-going hot wire to the load terminal. The neutral wires also use line and load terminals on the opposite side of the GFCI receptacle.

You can identify the GFCI primary receptacle by the test and reset breaker in the center of the device. Check the GFCI protection monthly. If a problem develops with the GFCI circuitry call a marine electrician to access the situation.

The GFCI outlets are especially useful when electrical equipment is employed such as a drill or in the head with the use of personal devices such as curlers and hair dryers. Never use any electrical devices when puddling water is present to prevent a possible shock hazard.

Note: See the GFCI breakdown on the following page.

The GFCI is programed to protect a person from line to ground shock hazards which could occur from various electrical devices operating off of the device or receptacles down stream. It does not prevent line to ground electric shock, but does cut down the exposure time to a fraction of a second before the device trips. It does not protect people against line to line or line to neutral faults. Also, it does not protect against short circuits or overloads; this is the circuit breakers job.

All GFCI's should be tested monthly to make sure they and the receptacles they protect “down-stream” are protecting against ground-faults.

## GFCI Outlet (Ground Fault Circuit Interrupter)

Newer style GFIC's must automatically monitor ground fault interrupting functionality every 3 hours or less. If the device can no longer provide GFCI protection, it must deny power and provide a visual indication that it can no longer provide protection.

Your boat uses a GFCI's featuring the following:

1. Power indicator (solid green)
2. Trip indicator (solid red)
3. "End of life" indicator (flashing red)

TEST BUTTON

GREEN LED

RESET BUTTON

RED LED

EARTH GROUND

NEUTRAL SLOT

HOT SLOT

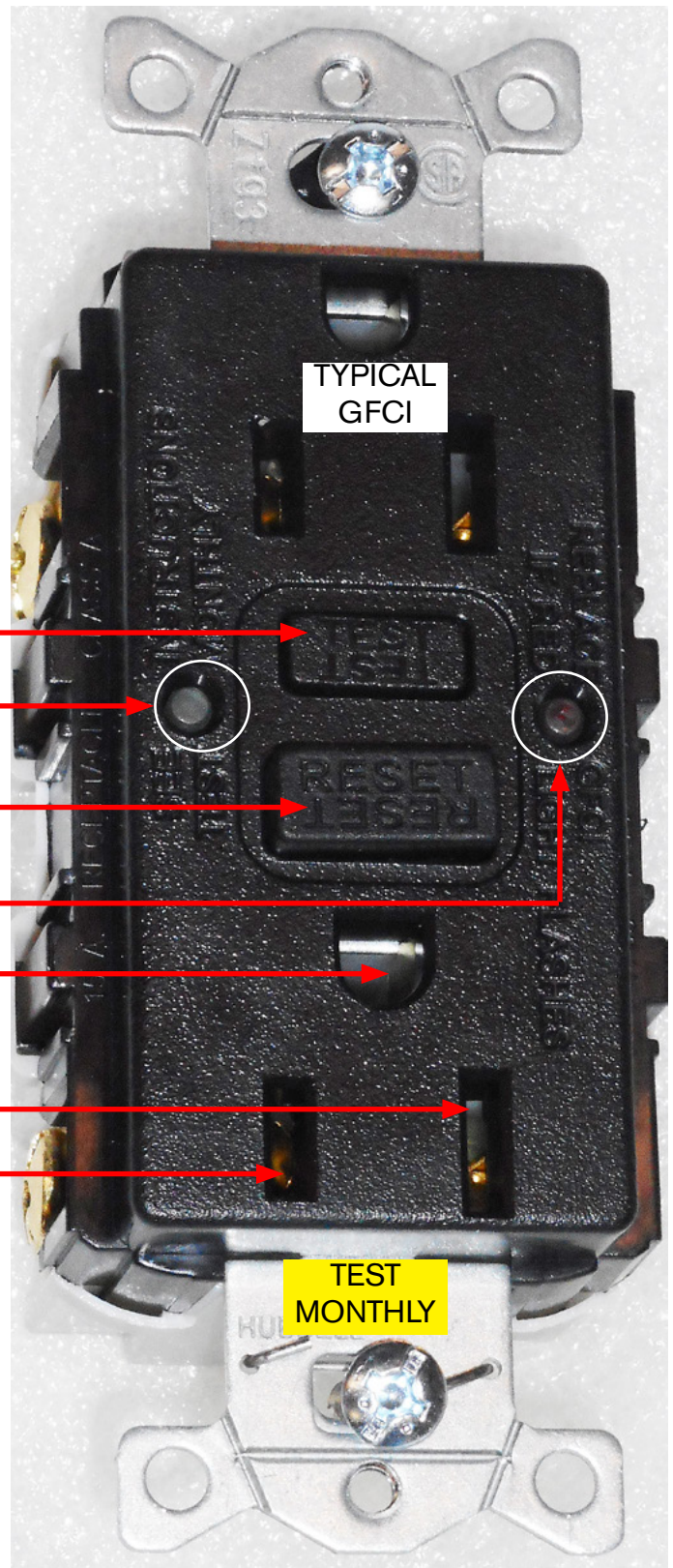

Normal operation when energized is for the Green LED to light as the outlet breaker is activated at the main AC ship's panel. If Red light flashes replace GFCI receptacle.

*Note that current GFCI's are rated for wet locations. If replacement becomes necessary make sure to match the amperage and location requirements.*

*Note that it is normal over the life of a GFIC to develop corrosion on the contacts due to the harsh marine environment which may lead to device failure.*

## GFCI Outlet Continued

### Testing GFCI'S

To test a GFCI find a 120 volt night light or small lamp to plug into the GFCI outlet. Try it in another circuit first to make sure it lights.

After the lamp is plugged into the GFCI outlet the lamp should light. Now press the "test" button at the GFCI receptacle center. The GFCI's "reset" button should pop out and the lamp should go out. This means the GFCI itself is functioning properly. Press the "reset" button to restore power to the outlet. Test each GFCI circuit monthly.

You can use the lamp to check receptacles downstream from the GFCI. All receptacles should light the lamp and should go out when the "test" button is pressed.



Also, GFCI downstream receptacles can be tested with a plug-in type GFCI tester. This tester contains a GFCI test button which accomplishes the

same thing as the GFCI receptacle built-in test button. This tester can be purchased at electrical supply houses or marine retailers.

## Possible Problems/solutions (GFCI's)

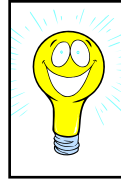

1. If the "reset" button does not pop out, the GFCI is probably defective and should be replaced.

2. If the "reset" button pops out one time but tends to stick the next the GFCI should be replaced.

3. The GFCI "reset" button pops out when something is turned on. This may indicate an internal wiring problem with the GFCI or there may be a ground-fault down stream.

4. The GFCI "reset" button is in the pressed position and nothing works. Check the appropriate breaker at the main ship's AC control panel to make sure it has not "tripped" or as been deactivated.

## Separate Stove/Grill In-Line GFCI Breakers (Ground Fault Circuit Interrupter)

### In-line Cockpit Stove GFCI Breaker-

The cockpit stove is protected with its own GFCI breaker. The breaker is mounted on the inside the starboard aft cockpit cabinet.

If the breaker “trips” it will require resetting. To reset the breaker do the following:

1. Pull out the top center cabinet drawer. See photo at right. Notice there is a alignment notch cut into the aft drawer side. See photo below.



2. Line up drawer notch with cabinet notch. Now the GFCI should be visible and accessible to reset.

The button closest to the hullside is the reset button. Press reset button until you can feel it reset.

Note that the inner button is the “test” button. To periodically test the GFCI press the test button and the GFCI breaker will trip. Next, press down the reset button until it resets.

It is recommended that GFCI's be tested monthly.

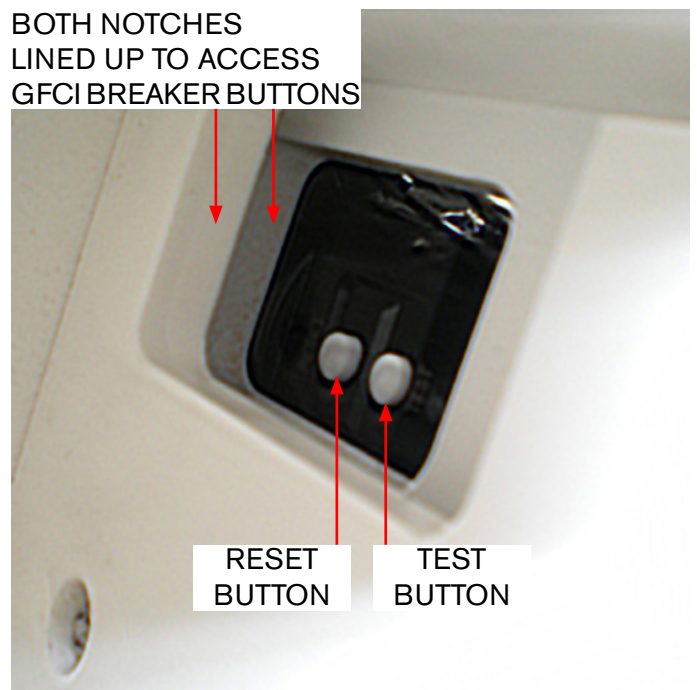



## In-line Cockpit Grill GFCI Breaker-

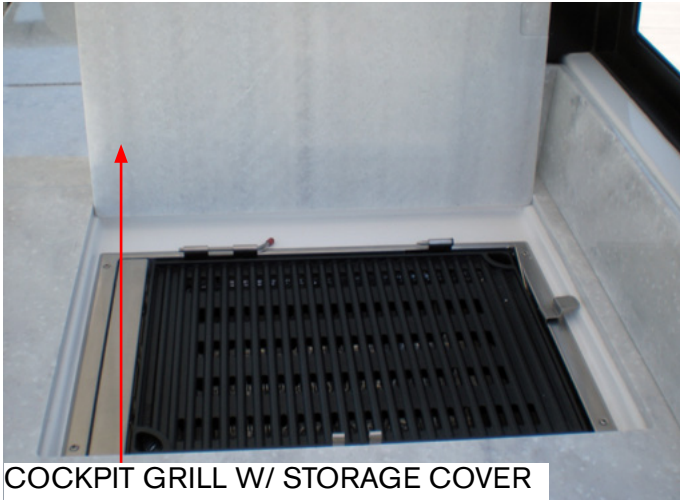

COCKPIT GRILL W/ STORAGE COVER

The cockpit grill is protected with its own GFCI breaker. The breaker is mounted on the inside the starboard aft cockpit cabinet.

If the breaker trips it will require resetting. To reset the breaker do the following:

1. Open the cockpit cabinet aft door to access the GFCI breaker. See photo at lower right.
2. Press reset button until you can feel it reset.

To periodically test the GFCI breaker press the test button and the GFCI breaker will trip. Next, press down the reset button until it resets.

It is recommended that GFCI's be tested monthly.

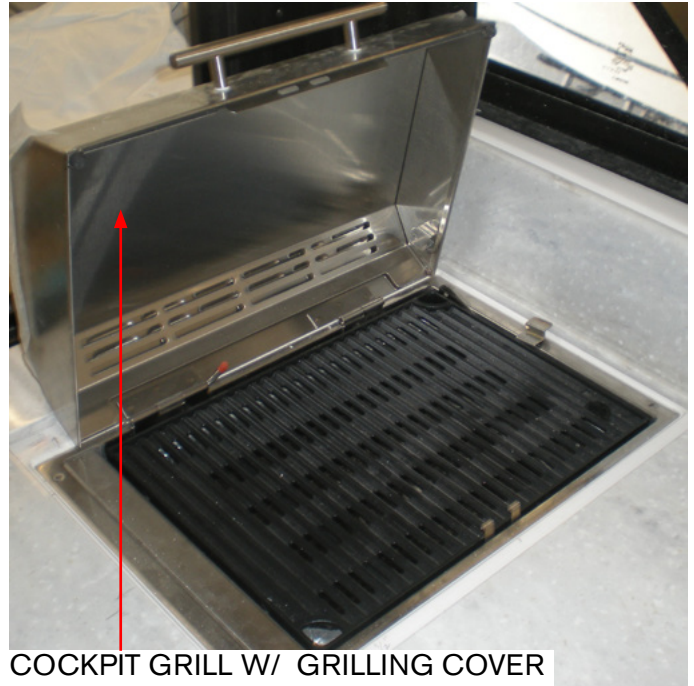

COCKPIT GRILL W/ GRILLING COVER

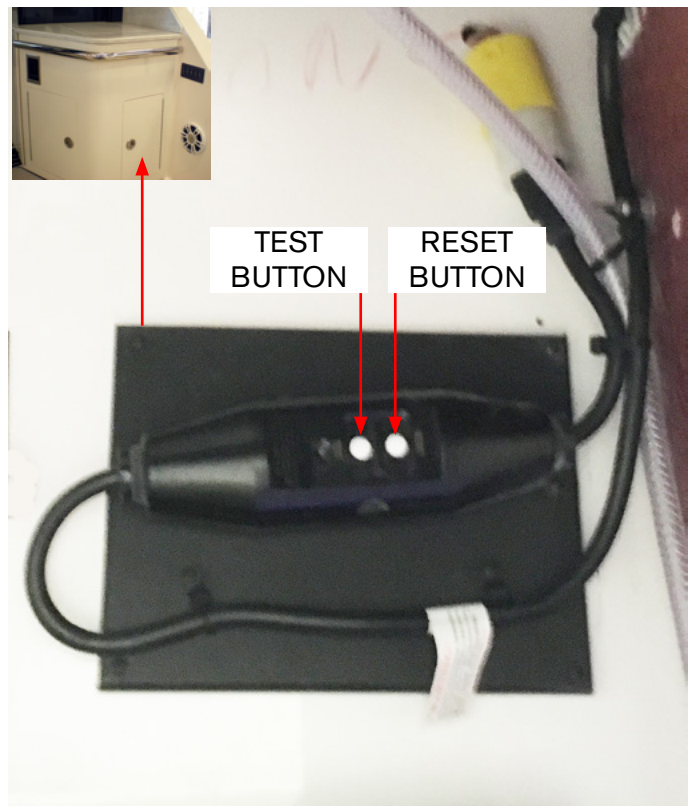

GRILL GFCI SHOWN WITH TEST/RESET BUTTONS INSIDE COCKPIT CABINET

## Ignition Protected Devices

Many electrical devices in everyday use tend to “arc” or spark when being used. These include motors, fans, switches, relays, etc.

Boats in general use many of these same devices but they are protected from any sparking that may cause the device to ignite with any vapors that are typically found in the engine room and/or fuel tank compartments.

When replacing any electrical device especially in the bilge or engine room make sure it is ignition protected. This means it has been tested and normally the device is stamped with a marking making it safe to use. Most automotive type devices are not ignition protected especially engine starters and alternators.

Note smaller hose barb for generator feed and return.

## Galvanic Isolator (Typical)

As part of the AC boat circuitry the green ground wire takes a different path. It enters via the boat's shore power inlet and travels to a galvanic isolator. Isolator is located behind the cabin main AC panel.

A 60 amp (60 hertz) galvanic isolator for domestic use is connected in series with the AC grounding



“green” wire. The purpose of the galvanic isolator is to isolate the boat's grounding system electrically from the dock and other vessels below 1.4 volts but to maintain a connection to the shore green ground at high voltage potentials. The low voltage isolation will prevent the vessel's zinc from protecting the underwater metal

hardware on another vessel sharing the same AC common green ground wire. This eliminates the possibility of galvanic interaction from other boats on the same dock circuit and permits your anodes to protect your boat. The green ground or “bonding wire” runs from the boat's shore power inlet to a galvanic isolator stud. From the other stud of the galvanic isolator it runs to the AC ground buss located behind the AC main ship's control panel in the salon. Note that the stud nuts must be torqued and maintained at 8.8 inch pounds.

Since the galvanic isolator is not polarized either terminal can be used for the inlet or outlet side for the green grounding wire. See the illustration.

There is a fan located at the right side of the isolator identified by an array of ventilation holes. If you ever hear the fan running the isolator has failed. Disconnect shore power at boat & check system.

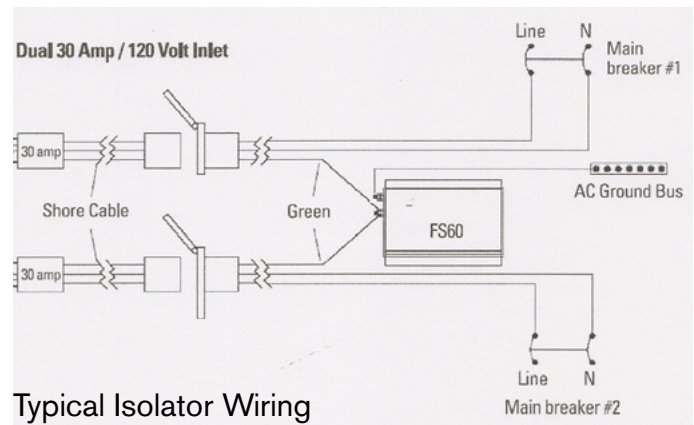

Typical Isolator Wiring

## Precautions/Galvanic Isolator Warnings

**Warning-** It is extremely dangerous to swim or be in the marina water due to potential AC current that may be present in the water. Take all necessary precautions as this may be life threatening.

**Caution-** This device does not provide a status monitor. Following a lightning strike this unit may not continue to provide galvanic isolation protection.

**Warning:** The fan will operate only when there is a fault to ground and the isolator is conducting current. If you notice the fan running immediately disconnect the shore power and contact a qualified marine electrician to isolate and repair the problem with the boat or the shore power connection. Remember, never cover the fan holes.

**Caution:** Never test the galvanic isolator. Troubleshooting the galvanic isolator shall be done by qualified personnel only.

## Gas Generator-Typical

### Overview

The following information is regarding the gas generator. If installed the gas generator (gen-set) is used to provide on board alternating current (AC) when the vessel is unplugged from the dock side cord. Generator frequency known as hertz is domestically set at 60 while overseas countries normally require a setting of 50. As the gas generator reaches full rated no load output (amps) at 60 hertz it should display 120 volts. At 50 hertz it should display 230 volts.

The generator is located in the bilge accessible through the Lazarette storage or engine hatch.

	<b>WARNING</b>
PREVENT INJURY OR DEATH DUE TO FIRE OR EXPLOSION! RUN BLOWER AT LEAST 4 MINUTES BEFORE STARTING ENGINE.	

	<b>WARNING</b>
GASOLINE VAPORS CAN EXPLODE! BEFORE STARTING ENGINE CHECK BILGE COMPARTMENTS FOR GASOLINE LEAKS OR VAPORS.	



TYPICAL GAS GENERATOR



## Ventilation System Notes

When a vessel features a gas engine of any type including generators in the bilge a powered ventilation system is used on board to dissipate any gasoline vapors. The powered ventilation system with the use of a blower system evacuates air from the lower third of the bilge where any gas fumes may exist. Intake and exhaust ducting is used in this process. A blower switch is found at the ship's main panel and the helm.

Always preform a bilge sniff test before starting stern drive engines or a generator. If the sniff test is positive deactivate all sources of power at the battery activation panel and seek professional assistance immediately to locate the source of vapor leakage! Do not attempt to start engines or generator!!!! Read and understand the warning label below.

Note that outboard vessels without generators feature a natural ventilation system.

 **WARNING**

PREVENT INJURY OR DEATH  
DUE TO FIRE OR EXPLOSION!  
RUN BLOWER AT LEAST 4  
MINUTES BEFORE STARTING ENGINES.  
CONTINUE TO RUN BLOWER WHEN  
ENGINES/GENERATOR ARE OPERATING.

 **WARNING**

PREVENT INJURY OR DEATH  
DUE TO FIRE OR EXPLOSION!  
NEVER STORE ANY TYPE OF FLAMMABLE  
LIQUID OR MATERIAL INCLUDING  
PORTABLE FUEL TANKS  
IN THE BILGE/LAZARETTE COMPARTMENT!

Periodic maintenance of the powered ventilation includes examining the intake and exhaust ducts for any obstructions such as debris or insect nests inside the ducting.

Make sure the exhaust hoses extend into the lower third of the bilge and they are not damaged in any way. Never obstruct or alter any part of the ventilation system.

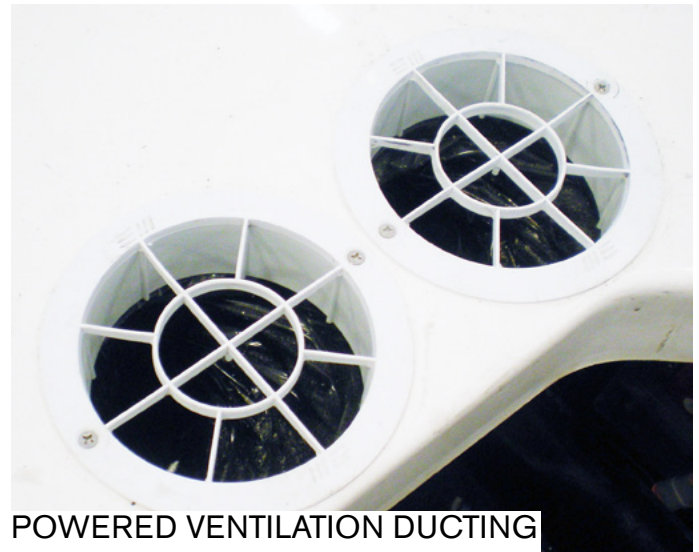

Note on outboard vessels with generators and stern drive vessels the exhaust ducting for the powered ventilation system can be recognized by the 4" black hoses attached to the lower portion of the duct fittings and run to the lower third of the bilge. Any fuel vapors will be exited through these exhaust hoses via the blowers to the outside environment. Note that fuel vapors are heavier and will seek the lowest portion of the bilge.

*Note that the intake ducting for the ventilation system may not have hoses attached to the ducts.*

## Typical Generator Fuel System

The gas generator is supplied by the same fuel tanks as the engines. The generator feed valve is normally marked for identification purposes.

Familiarize yourself with the location of all equipment and valves.

Note: Normally the generator feed and return use a 1/4"inch barb fitting located on the fuel tank. The feed portion will use a anti-siphon valve.



The fuel system may feature an in-line fuel filter located close to the generator. It's job is to keep fine particles and water out of the generator fuel system. Most generators feature a second element style filter

inside the cowling. Refer to the vendor information for periodic maintenance schedules.

Remember that clean fuel is the life line of generator performance.

Since water is heavier than fuel it will settle at the bottom of the water separator filter. Periodically check the filter for foreign debris and water in the fuel supply. To check the filter unscrew the filter using an oil filter type wrench that fits on the bottom.

Do not use a strap type wrench since it may distort or damage the filter housing. Use an environmentally safe container to catch any contaminated fuel. Dispose of according to local, or state regulations. Carry extra water separator filters on board.

When you turn the filter upside down note that any water in the gasoline will gather at the bottom of the container since it is heavier than gasoline and will appear as a different color and consistency and normally will move back and forth independently from the gasoline mixture in the container.

After inspection spin on the filter by hand until tight. Start the engine and check for fuel or air leaks.



## WARNING

GASOLINE VAPORS CAN EXPLODE!  
BEFORE STARTING ENGINE  
SNIFF BILGE COMPARTMENTS  
FOR GASOLINE LEAKS OR VAPORS.



## WARNING

PREVENT INJURY OR DEATH  
DUE TO FIRE OR EXPLOSION!  
RUN BLOWER AT LEAST 4  
MINUTES BEFORE STARTING ENGINE.



## WARNING

USE OF ALCOHOL ENHANCED FUEL,  
OR ANY FUEL OTHER THAN GASOLINE  
CAN LEAD TO DETERIORATION OF THE  
FUEL SYSTEM COMPONENTS. THIS CAN  
RESULT IN FIRE AND POSSIBLE EXPLOSION.

## Typical Generator Electrical System

The generator starting system uses the house battery. The generator is normally started at the 12 volt ship's control panel located in the cabin but it can also be started using the remote instrument panel located at the generator itself as needed. The latter is especially useful while maintenance is being conducted.

The generator remote instrument panel normally features temperature, oil pressure, exhaust, speed, hour meter, on/off, start and stop switches. This panel is found inside the access door on the generator sound enclosure in the bilge. The start and stop switches by name and function are identical to the switches on the remote panel.

As part of the generator electrical system a fuse protects the remote instrument panel wiring circuit. See illustration.

The emergency stop switch shuts the fuel off to both the remote and ship's main control panel and is normally for maintenance purposes.

A DC manual reset breaker protects excessive current draw or electrical overload anywhere in the generator engine wiring. Should this breaker trip the generator will shut down. Reset the breaker only after the cause of the problem has been determined. See illustration.

An AC breaker will automatically disconnect any generator AC power from reaching the main ship's control panel in case of an electrical overload. It can be manually shut off when performing generator maintenance to ensure no AC power is coming out of the generator. See illustration.



# WARNING

**TO PREVENT POSSIBLE GENERATOR DAMAGE ALL SHORE POWER BREAKERS AND AC SWITCHES NEED TO BE DEACTIVATED BEFORE STARTING OR STOPPING GENERATOR.**

## Before Starting Generator

The following items should be checked each time before starting the generator. This covers the basic system components.

- Turn generator sea cock off. Check strainer for debris. Turn generator sea cock on before starting it.
- Ensure that all main panel and equipment breakers are off.
- Inspect the generator for fuel, oil, exhaust or water leaks.
- Check generator engine oil level. Top off with correct viscosity as required.
- Check coolant for proper level at recovery tank. Add as needed.
- Check the main fuel tank to ensure there is adequate gasoline for both the generator and the engines. Apply the one-third rule.
- Check for loose wires at the alternator.
- Check the port side cranking battery (weekly).
- Check drive belts for wear and proper tension (weekly).
- Record the hour meter reading to meet maintenance scheduling.
- Check the blower for proper operation. Start blower and let run at least 4 minutes before attempting to start the generator. Run blower continuously while generator is running.
- Check the water surrounding the aft platform for persons in the water. Do not attempt to start the generator with persons in the water as generator exhaust could overcome the individual with CO poisoning and lead to drowning. Never let persons near the generator exhaust which is located on the starboard transom.

## Typical Generator Exhaust System

The generator exhaust system features a dual tier operation. As the water and exhaust exit the generator they travel to the muffler. The muffler discharges the heavier water out the muffler bottom and through the hull. The exhaust itself is exited out the muffler top and through the hull. The benefits of the system are two-fold. First, the actual decibel or sound level is decreased. In addition, the lower resonating sound is more pleasing to the ear.

Before departure always check the hose connections for signs of water and air leaks. Tighten hose clamps periodically as needed. Check entire exhaust system for leaks and fastener tightness.

After starting generator, check for water flow at the generator discharge.



## Starting Generator

The following gasoline generator starting information is specified for use at the ship's main control panel located in the cabin. *It also assumes that the checklist on the last page has been completed and all system components are in good running condition.* For further information, contact your closest Regal dealer, refer to the generator operation manual and/or the illustration of the ship's panel.

1. Turn "on" the generator sea cock in the engine room.
2. Check the ship's main control panel to ensure shore main and all equipment breakers are deactivated.
3. At the ship's main control panel activate the generator blower. Let it run for at least 4 minutes before starting the generator.
4. Activate the toggled "start" switch and hold. This will engage the generator starter to crank over the gen-set engine.
5. Once the generator starts, release the "start" switch.
6. Let the generator run without a load for several minutes.
7. At the ship's main control panel slide the starboard parallel (transfer) bar up.. Activate the breaker.
8. Push the port bar up. Activate the generator breaker.  
At this point AC voltage should display on the AC line voltage meter.
9. Activate the desired AC equipment breakers.

## Stopping Generator

To stop the generator follow these steps at the ship's main control panel;

1. Turn to the "off" position all AC equipment breakers.
2. Turn to the "off" position the 50 amp AC generator breaker. At this point, no AC line voltage will be displayed at the AC volt meter. Let the generator run for 3-5 minutes without a load to cool down.
3. Stop the generator by activating the "stop" switch on the panel. Hold switch until generator stops.

## Possible Generator Problems/Solutions



1. With generator main control panel activated there is no voltage at the AC line voltage meter. Check AC output breaker on the generator. It may of tripped due to an overload.

2. The generator quit do to overheating. Check the generator strainer for obstructions such as seaweed, plastic, or shellfish. Be sure to turn off sea cock before removing the strainer basket.

3. The generator will not start from the main ship's panel after being serviced. Make sure the generator mounted emergency stop switch is in the "off" position and the breaker has not tripped..

4. The generator will not crank over to start. Check-out the house accessory battery and remote battery switch.

## Generator Seacock/Strainer



To service any on board strainer make sure the seacock handle is in the "off" position (90 degree angle to the hose). Turn the strainer top counterclockwise to access the basket, Pull the basket out and remove any debris. Reinstall basket and tighten

strainer top. Set the sea cock handle to the "open" position. Start generator and check for leaks.



CLEANING STRAINER BASKET

## Diesel Generator-Typical

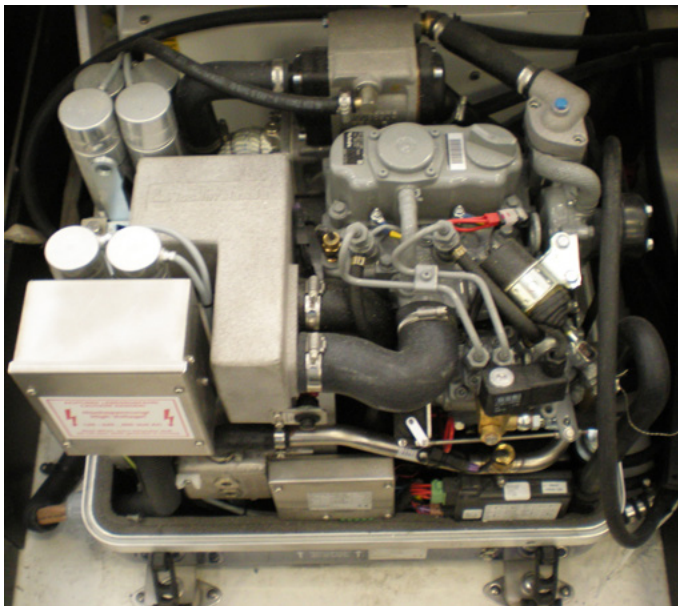

DIESEL GENERATOR

## DIESEL GENERATOR WATER SEPARATOR



EXHAUST DISCHARGE TO TRANSOM	WATER DISCHARGE HULL BOTTOM SEACOCK	FROM GENERATOR MUFFLER IN BILGE
---------------------------------------	--	--

The generator water separator system is located on the port hull side. Read the descriptions of each system component. Bottom line the system muffles the generator sound and exits exhaust safely overboard.

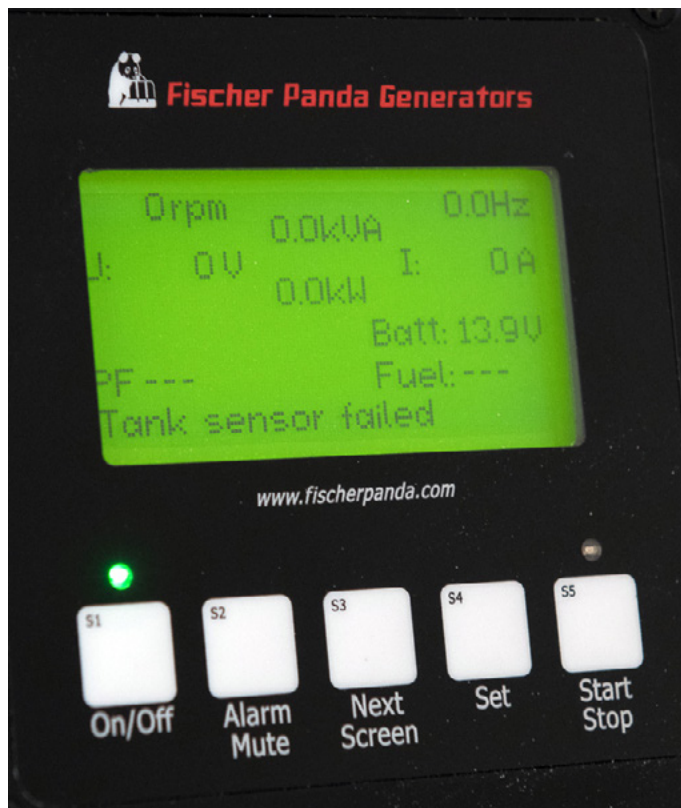

DIESEL GENERATOR DISPLAY PANEL

There is a diesel generator display panel mounted at the port cabin wall, The unit can be started and stopped from the display panel. Also, there are additional screens for engine monitoring including an alarm system for critical components.

## Diesel Generator Seacock/Strainer

Note that the diesel generator uses the same type of seacock/strainer as the gas type. Refer to the strainer maintenance instructions on the previous pages.



## Diesel Generator Fuel System



**DIESEL GEN-SET PRIMARY IN-LINE WATER SEPARATOR FILTER**

*Note that an optional diesel generator features a 28 gallon diesel fuel tank.*

### Diesel Water Separator Filter System

The diesel generator fuel system is outfitted with a 10 micron in-line filter. This filter is the first line of defense for the generator. It removes water and solid contaminants from the fuel supply before they enter the generator. It is of the spin-on type similar to oil filters.

Also, there is a secondary cartridge style fuel filter mounted on the generator itself. See illustration.

It is recommended that you carry extra spin-on replacement filters along with a cartridge filter for the generator itself. Change filter components at least annually.

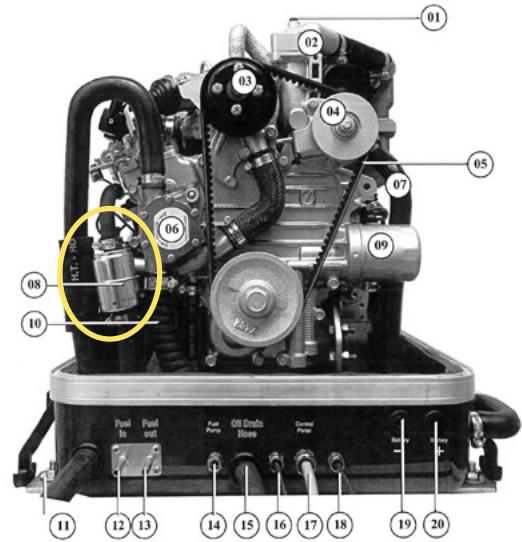

- |  |   |
|--|---|
| 01. Ventilation screw thermostat housing   | 11. Raw water inlet                             |
| 02. Thermostat housing with thermostat set | 12. Fuel intake connection                      |
| 03. Pulley for internal cooling water pump | 13. Fuel backflow connection                    |
| 04. Pulley V-belt                          | 14. Passage for cable fuel pump                 |
| 05. V-belt                                 | 15. Oil drain hose                              |
| 06. Raw water pump                         | 16. Cable for remote stop                       |
| 07. Freshwater intake pipe                 | 17. Cable for the control panel                 |
| 08. Fuel filter                            | 18. Passage for fuel level switch               |
| 09. Engine oil filter                      | 19. Passage for cable starter battery minus (-) |
| 10. Hose for raw water intake              | 20. Passage for cable starter battery plus (+)  |

### SECONDARY GEN-SET FUEL FILTER

Normally accumulated water or debris in diesel fuel results in no or hard starting, rough idle, bogging down on acceleration or poor performance.

Water and debris are the worst enemies of the diesel fuel system.

For further diesel generator information refer to your diesel generator operator's manual in the owner's information satchel.



## Air Conditioning

### Introduction

The current air conditioning system features domestically 2 units: 16,000 & 18,000 BTU output at 120 volts and 60 Hz. The system utilizes a single pump which delivers cooler seawater to both evaporators/condensers. The drain pan is rust free molded composite. Residue water exits through the shower box. Warmer seawater exits the vessel through a manifold and various thru-hull fittings.

A vibration isolation system reduces noise. The sound cover provides up to 50% further noise reduction which amounts to 3-5 DB's.

The evaporator/condenser unit utilizes a compressor to compact the R-410A refrigerant which is comprised of fluorinated greenhouse gases.

The Elite control panel (thermostat) is centrally located in the cabin to serve the vessel needs. A set of control panel reference system codes is provided for any type of service issue.

The A/C pump is located in the engine room. It provides sea water to operate the A/C unit located at the forward berth floor. The A/C pump relay box is located behind the aft condensor unit in the mid berth accessible by removing rear panel covering.

### **Important Note:**

***If the vessel is hoisted out of the water (except for winterization) make sure the A/C sea cock is turned to the "off" position before lifting the vessel. Failure to do so may cause the air conditioner to lose its prime and the A/C pump may quit on start-up do to a lack of water or cause pump failure. Turn the sea cock "on" before re-starting the A/C unit.***

TYPICAL AIR CONDITIONING EVAPORATOR/CONDENSER UNIT

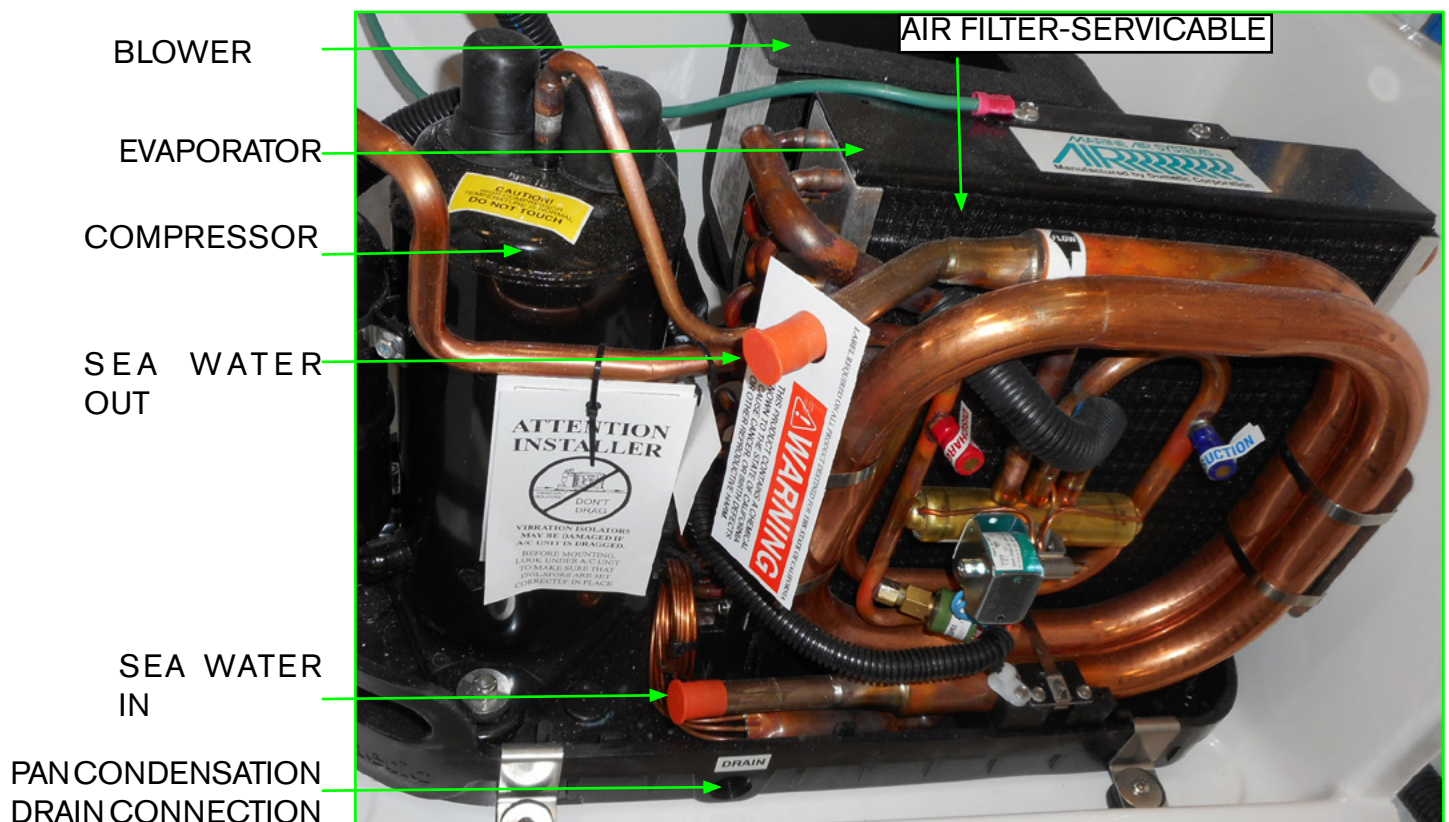

## Air Conditioning System Introduction (Con't)

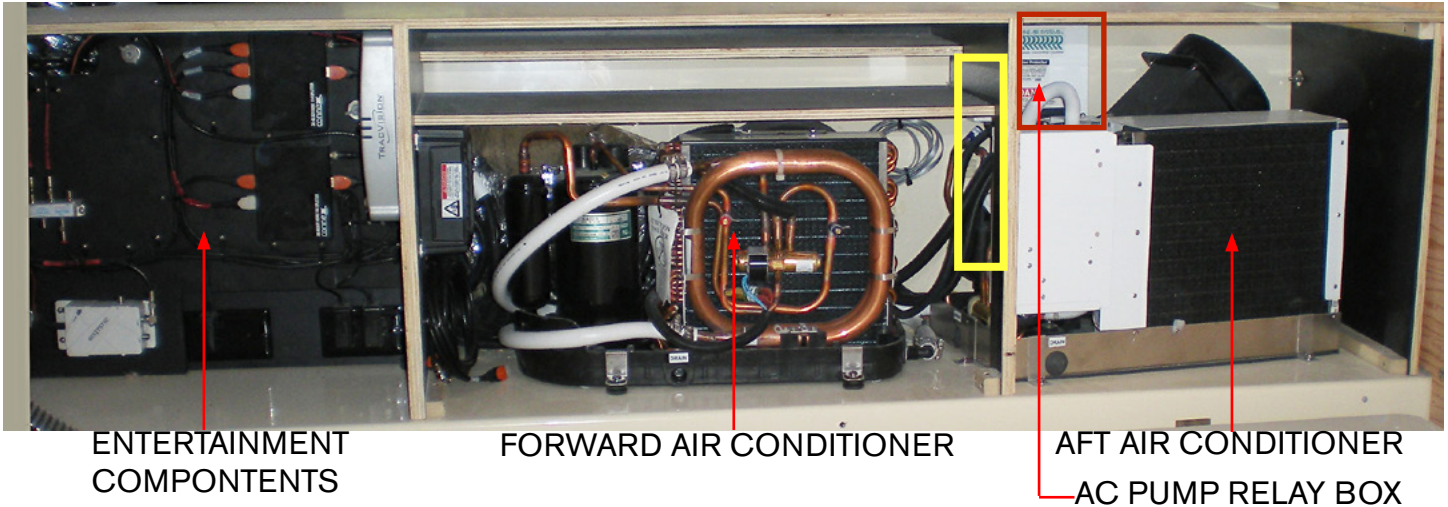

Located inside the starboard mid-berth cabinetry is the forward positioned 16,000 BTU. air conditioning unit and the aft positioned 18,000 BTU unit.

The forward air conditioner feeds the forward cabin, head, and mid berth.

The aft air conditioner feeds the cockpit along with vents at the wet bar and helm areas.

Service access to the aft AC unit is gained by removing the covered panel.

Service access to the forward AC unit without the optional mid berth TV is gained by removing the covered panel.

Access to the forward AC unit with optional TV requires you to reach in the pocket at the forward side of the aft air conditioner cabinet to lift the air filter up and out of the slots. The aft AC unit has been slanted and a pocket integrated into the cabinet to reach the forward AC filter (**See yellow square in above photo**).

The system AC pump relay box is located inside the aft air conditioner enclosure. *Note there are high voltage components inside this box. Voltage would match AC pump voltage which is 120 volts on your vessel. See photo at above right.*

Also, note that the pan condensation drain should be periodically checked for debris. To clean tray, use a 50/50 bleach to water solution in the tray. The tray will drain into the collection box and be pumped overboard by the gulper pump.

### Air Filters

Both AC units use a mesh reusable air filter located on the condenser wall. These filters keep the evaporator cool. Once access to the AC unit is reached simply lift the filter up from the slots. Clean with fresh water, rinse and once dried replace in the slots. Check the air filter on a monthly basis.



## Reverse Heat

The air conditioning system feature a reverse heat cycle. This can be extremely valuable to boaters in colder climates especially for early spring and late fall cruising.

To accomplish reverse cycle heating, the R-410A refrigerant flows in the opposite direction through a reversing valve located on the evaporator/condenser unit. Heat is transferred from the seawater in the coil of the condenser to the R-410A refrigerant and then to the air as it is blown through the evaporator to the cabin.

Obviously, the temperature of the seawater will affect the air conditioner efficiency.

The temperature variance for cooling efficiency is:

Up to 90 Degrees F. ( 32.2 Degrees C. )

The temperature variance for heating efficiency is:

Down to 40 Degrees F. ( 4.4 Degrees C. )

## Typical Air Conditioning System Operation

### Operations Quick Start-Up Checklist:

1. Check the AC seawater strainer for debris.
2. Make sure the AC seawater pump sea cock located in the engine room is opened completely (handle should be in-line with the hose).
3. Activate the cockpit air conditioner and/or cabin air conditioner breaker on the boat's main AC control panel located inside the cabin locker.
4. Activate the AC pump breaker at main AC panel. Power will be sent to the relay box in order to start the pump up as the Elite control panel is energized.
4. With control panel activated check the hull side for a steady stream of seawater. Seeing water here is normal when the AC pump is running. If stream is diminished or no water emits from the fitting immediately turn the AC pump off and investigate.
5. For cooling or heating press and release the Mode button until the desired LED is illuminated ie; automatic mode.
6. Press the Up or Down button to set the desired cabin temperature. To view the set point, momentarily press and release the Up or Down button.
7. Auto fan LED lights when Auto fan speed is selected.

***Note that the same AC pump runs both air conditioner systems.***



## TYPICAL ELITE AC CONTROL DIAGRAM

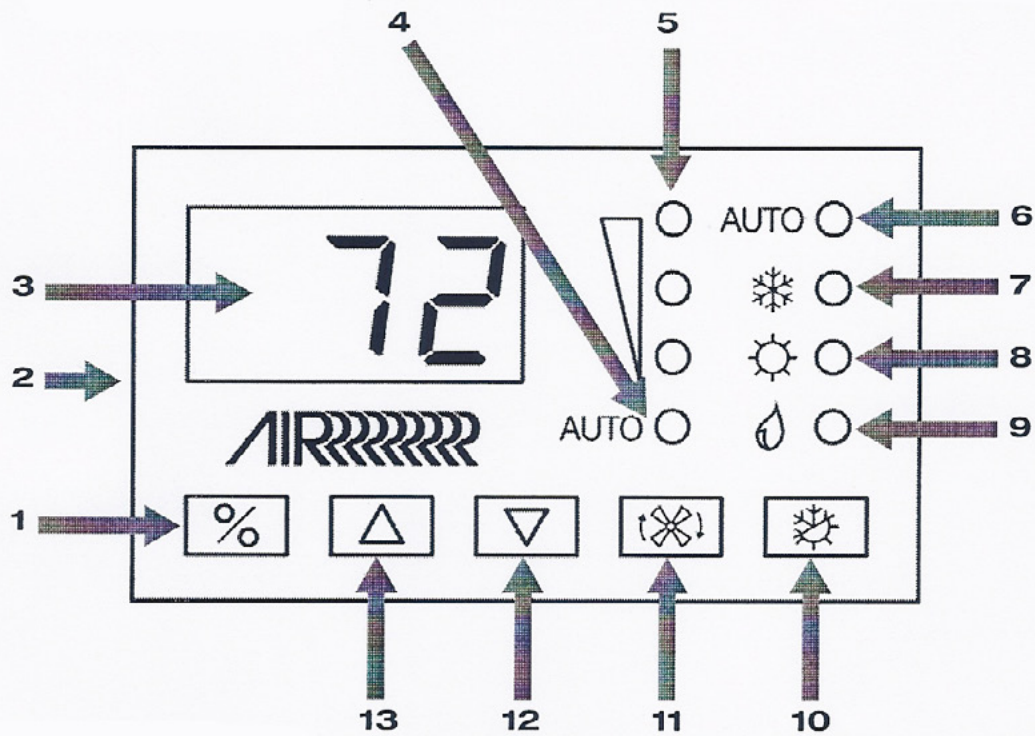

**Elite Display - Diagram Legend**

1	Power button	8	Heat Mode indicator
2	Temperature sensor	9	Moisture Mode indicator
3	Digital display	10	Mode button
4	Auto Fan indicator	11	Fan button
5	Manual Fan indicator (high, medium, low)	12	Down button - Lower temperature set point
6	Auto Mode indicator	13	Up button - Raise temperature set point
7	Cool Mode indicator		



*Note: The Elite display continually monitors the system components. Should a problem develop it sends a diagnostic code to the control (thermostat) display. Refer to the vendor air conditioning manual (troubleshooting section) to assist in identifying the problem.*



## Fault Codes

Below is a short listing of possible fault codes for the air conditioning system. Note the codes are abbreviated as they appear on the elite controller. Always investigate the cause of the code before reactivating the system.

For additional information refer to the air conditioner owner's manual.

### Fault and Status Codes

Code	Description	DX
HPF	High Pressure Switch Fault: indicates high refrigerant pressure. This fault is not applicable in HEAT mode.	x
LPF	Low Pressure Switch Fault: indicates low refrigerant pressure. This fault has a three-minute shutdown delay (for display firmware #41 and newer).	x
PLF	Low Pump Flow Fault: indicates high-water temperature in the condensing coil or low pump flow.	x
ASF	Inside Sensor: indicates the display built-in temperature sensor is damaged or not connected.	x
FIL	Indicates the air filter replacement timer has expired.	x
SAH	Indicates a high supply air temperature limit.	x
LC/UL	Indicates a locked or unlocked display mode, although some buttons do function. Refer to "Using the Control Display Panel" on page 13.	x
LSF	Indicates a seawater low limit.	x
LAC	Low Voltage Fault: indicates low voltage. This fault offers extra protection for the compressor and components within the system during low-voltage (brownout) conditions.	x

## Typical Air Conditioner Inspection Tips

### Seawater Strainer

The air conditioner seawater strainer is located in the bilge and should be cleaned periodically of debris which can inhibit or stop the fresh sea water supply.

Always turn the sea cock handle to the off position (90 degrees to the hose fitting) before cleaning a seawater strainer.

Remove the basket by turning the plastic cap in a counterclockwise direction. Set the cap and the O ring aside. Pull the basket from the unit, rinse with water, air dry and reinstall. Sediment at the bottom can be removed by just turning the plug in a counterclockwise direction. Place a container under the strainer to catch the sediment. Coat the O rings with waterproof grease containing a silicone or teflon base. Reinstall O rings along with the plug and plastic cap. Turn on and check for leaks. Refer to the technical section for location of sea-cock/stainer. It is in-line with the AC pump.

### Drain Pans

As noted on an earlier page the AC evaporator/condenser features a 2" deep drain pan connected by a hose that runs to a sump pump and eventually exits overboard. Periodically just like your home AC, the pan needs to be rinsed clean of debris and possible mold.

You can use a purchased product made specifically for cleaning AC units. Disconnect the outlet hose from the AC pan and install made up hose (5/8") that will catch the used solution to fill a small container. Dispose of the container in accordance with federal, state and local regulations. Pour the solution into the pan and allow time for it to drain. Reconnect the original drain pan hose when finished.

### Condenser Coil Cleaning

Periodically the condenser coils are recommended to be cleaned. This procedure should be performed by a professional since an acid solution must be used.



## WARNING

PREVENT INJURY OR DEATH!  
DISCONNECT  
ALL ELECTRICAL POWER SOURCES  
BEFORE ATTEMPTING  
TO OPEN, REPAIR, OR REPLACE ANY  
AIR CONDITIONER COMPONENTS.

## Possible Air Conditioner Problems/Solutions

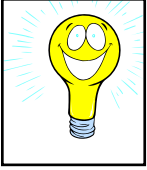

1. No or little water is noticed at the thru-hull fittings and a HPF fault code shows on the display which means the high pressure switch is open.

The strainer or intake hose may be clogged, sea cock may be closed a hose may be collapsed or the AC pump may be defective.

2. Air conditioner will not start. Ensure the proper AC breaker is activated on the ship's main control panel.

3. No cooling or heating. Lower or raise set point on thermostat control to offset set point being satisfied. Check for obstructed seawater flow. Remove discharge side of pump hose to purge air (air-lock). Seawater temperature too high for cooling and too low for heating.

4. Fan coil is iced. Raise or lower control set point. Clean return air filter. Switch AC to heat until ice melts or as a last resort use a hair dryer to melt ice as needed.

## Gasoline Fuel System

In this section, a typical EPA approved domestic gasoline fuel system is introduced. The fuel system includes the fuel tank, fuel feed lines, fill and vent fittings along with fuel filters, emission devices, natural and powered ventilation systems.

Gasoline today is processed in a different manner than it was a few years ago. As a result it has become more unstable and the product shelf life has been shortened.



Note that outboard propulsion in this size range utilize a special low permeability bulb and hose supplied by the engine manufacturer to feed the fuel from the tank to the outboard engine. Sometimes it is

necessary to pump the gas line hose bulb before starting the engine. *Note that the fuel line bulb and hose for each engine is in the lazarette storage area. The above information does not apply to stern drive models.*

If the need arises to replace the fuel bulb be sure to turn the arrow imprinted on the bulb toward the engine side for correct fuel flow.

Read and understand the outboard owner's manual fuel section and safety information before attempting to use the vessel.

*Note that due to a possible fire or explosion danger never store flammable liquids and/or portable fuel tanks of any type in onboard storage compartments such as the cockpit Lazarette locker.*

Gasoline Specifications/Octane Ratings:

Gasoline Requirements- **Use premium non-lead-ed gasoline** with the following minimum domestic octane rating for Yamaha and Volvo propulsion:

• **Minimum pump octane number (PON) is 89.**

The use of leaded fuels will damage the catalysts and can not be used with catalytic converters.

Gasoline in the United States and other areas is blended with 10% ethanol and is known as E-10 at the pumps. Marine engines used in your Regal boat may be operated with premium unleaded gasoline blended with no more than 10% ethanol and that meets the minimum octane specification.

Do not use ethanol blends greater than 10% such as a newer blend for select motor vehicles called E-15 or E-85. Your marine engine may be damaged by more than 10% ethanol. A loss of performance may occur and the engine will not be covered by the engine manufacturer's warranty.

Refer to your propulsion manufacturer's operation manual for additional information regarding the proper octane level for your engine model. Using the wrong octane level may cause permanent engine damage such as piston detonation.

As an option contact your engine manufacturer's hot line or surf the web with fuel related questions. Also, additional fuel system information is as close as your Regal dealer. Your Regal dealer has special training on propulsion and Regal vessel systems.



## Typical EPA Fuel System

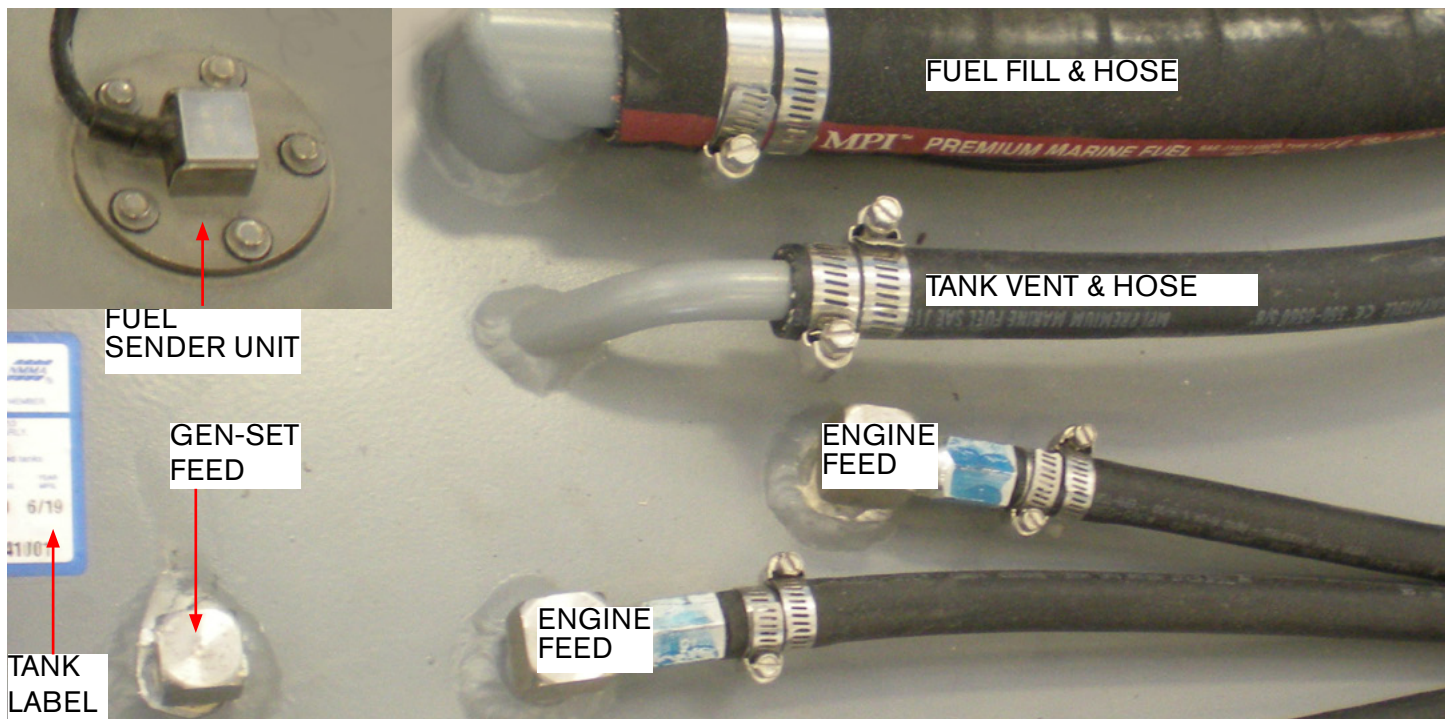

## Typical Fuel Tank

Vessels manufactured for *domestic* use are now required to be outfitted with an EPA compliant fuel system using an aluminum tank that passes a variety of tests. This system uses special valves and baffles located inside the fuel tank along with special hoses marked for low permeability. Also, there is a carbon canister in-line with the vent hose which functions much like the one in an automobile by filtering gas fumes. The carbon canister rarely needs to be replaced and is not a serviceable item.

These tanks are tested and inspected along with the complete fuel system several times for safety requirements and quality by the fuel tank supplier, in house personnel and independent inspections by National Marine Manufacturers Association personnel.

## Fuel Fill Fitting

The fuel fill fitting is labeled “gas” and in addition displays the international symbol (See the next page). When fueling the boat keep the fill nozzle in contact with the fuel fill pipe since it decreases effects of static electricity. Always use the recommended fuel octane rating as specified in your engine owner’s manual.

*Extinguish all flame producing agents before fueling!*

 **WARNING**

AVOID SERIOUS INJURY OR DEATH FROM FIRE OR EXPLOSION, RESULTING FROM LEAKING FUEL. INSPECT SYSTEM FOR LEAKS AT LEAST ONCE A YEAR.

## Fuel Vent Fitting - Typical



COMBO FUEL FILL/  
INTERNAL VENT

Currently, domestic EPA compliant fuel tanks vent fumes back into the fuel tank system. While the tank is filled, air displaced by the incoming fuel is vented through the fuel system charcoal canister.

Your vessel uses a combo type (internal vented) fuel fill. Both the fuel fill and vent occupy the same cavity under a protective cover. If fuel overflows through the vent the design forces it back into the fuel fill hose and tank. Be sure to tighten the fuel fill cap to prevent water and debris from entering the fill system.

A seasoned skipper will hear a distinct sound as the tank nears the “top out” or full mode and may see fuel overflowing back into the fuel hose through the vent. On select vessels not using an EPA fuel system there may be a separate vent fitting on the hull side. Periodically check this vent screen for debris and insect activity.

# NOTICE

DO NOT OVERFILL THE FUEL TANK!  
THIS HELPS AVOID ANY OVERBOARD  
SPILLS WHICH MAY HARM THE  
ENVIRONMENT

## Anti-Siphon Valve

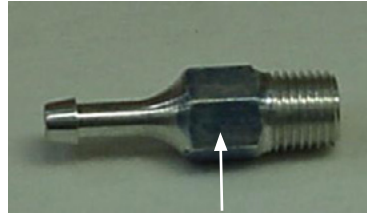

INTERNAL BALL/SPRING

The gasoline fuel tank feed line that runs from the fuel tank to an engine or generator fuel component uses an

anti-siphon valve. The valve is threaded into the fuel tank fitting at the feed line. The valve is pulled off its seat by fuel pump pressure as the engine is cranking or running. There is a ball and spring assembly inside the valve that is activated by fuel pump impulses. It allows a one-way fuel roadway to the engine or generator fuel system. It prevents fuel from siphoning out of the tank in the event of a fuel line rupture or disconnected fuel feed hose. When the engine fuel components stop the fuel from cycling the spring forces the ball against the valve opening to prohibit fuel flow.

Never remove an anti-siphon valve as it is a fuel system safety component. Also, never remove the ball and spring from the anti-siphon valve assembly. The anti-siphon valve requires no normal maintenance. Symptoms indicating possible valve problems may be fuel starvation at intermediate or high rpm or in extreme cases an engine that will not start.

Contact your Regal dealer for further information.

## Fuel Gauge & Sending Unit

The fuel volume is available on the Garmin engine display. The fuel sender shown on the EPA fuel system uses a float system suspended in the tank to send a signal to the Garmin display regarding the amount of fuel remaining in the tank.

Since larger fuel tanks usually feature baffles the signal generated by the float is steady and accurate.

## Fuel Storage On Board

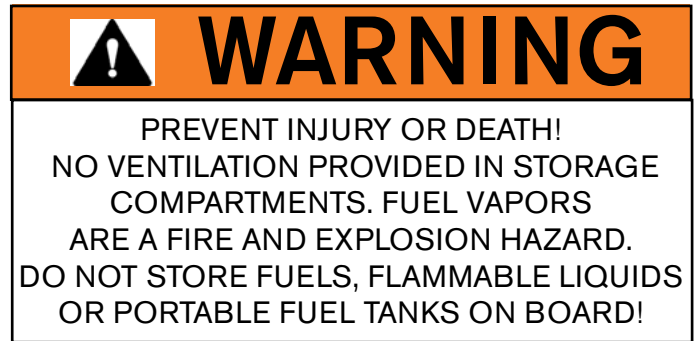

Read and understand the label above regarding the storage of flammables on board the vessel. Also, do not store auxiliary portable fuel tanks on board the vessel since these portable tanks emit vapors into the atmosphere.

## Fresh (Potable) Water System

### Overview

There is a fresh water supply onboard known as a potable (drinkable) water system. The system includes a fresh water tank/sender, fresh water pressure pump/filter along with various hoses, connectors, fill/vent hardware, faucets, and a monitor panel. We will review the main system components to aid in understanding how the system works.

*Note that various components in the fresh water system require periodic maintenance to ensure the system continues to run effectively.*

### Fresh Water Tank

Normally the fresh water tank is manufactured from aluminum for increased strength and longevity. The tank utilizes a sender which senses the tank water level and displays an approximate amount on the fresh water section of the monitor panel. Refer to the typical fresh water tank components shown in the photo.

### Fresh Water Fill/Vent



The fresh water tank fill is normally located on the starboard deck with a nearby system vent. Simply remove the cap on the fill labeled

“water” and fill with fresh water until you see water exiting through the vent. This tells you the potable water tank is full and ready for use. Tighten the cap when finished filling system to keep debris out of the tank. Always line up the 2 blue dots for complete fitting closure.

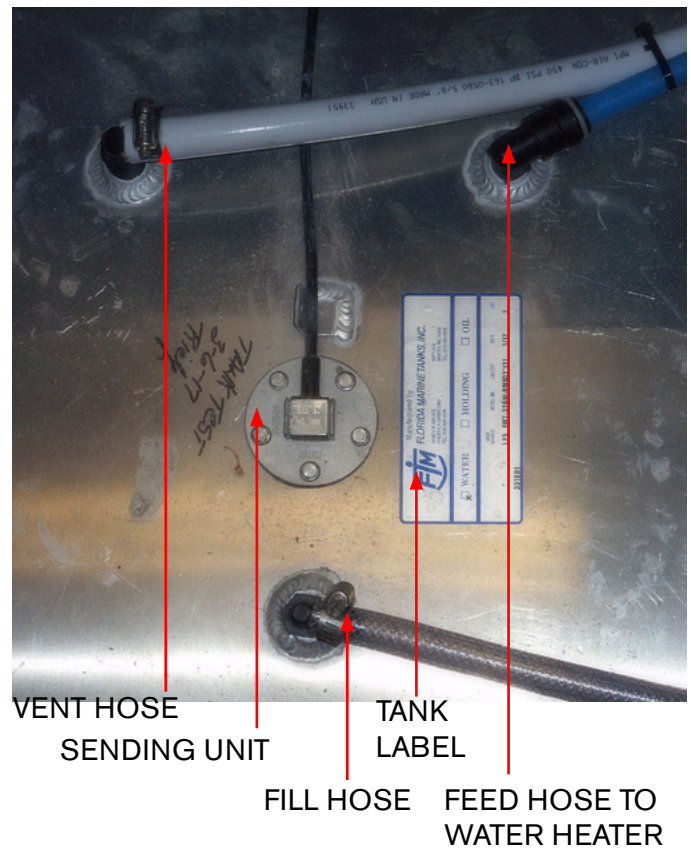

### Sending Unit

Note there is a fresh water sending unit located on the tank top. This sending unit measures the amount of available potable water and sends a signal to the monitor panel. When the top portion of the monitor panel switch is pressed the gauge shows the amount of water in the fresh water tank. This reading is approximate as there is a margin of error involved. Always check the monitor panel fresh water level before each outing or extended cruises.

### Fresh Water Feed Hose

The fresh water feed hose runs from the fresh water tank to the fresh water pressure pump. It is normally a blue hose which signifies “cold water”.



## Fresh Water Pressure Pump (Typical)

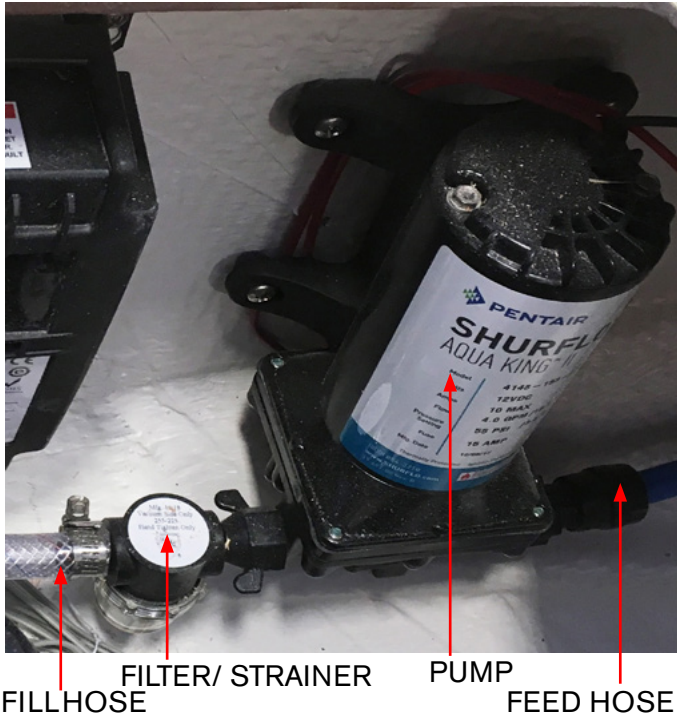

### Operation

The 12 volt fresh water pump supplies potable water to various fresh water components on the vessel. At the helm panel a fresh water switch controls the wash down hose located under the port gunnel along with sink faucets normally located in the cockpit and head. Also, the transom shower utilizes the fresh water pump. The fresh water switch must be activated for any of the above components to operate.

Periodically the water filter strainer located near the fresh water pump needs to be serviced. Inside the filter there may be a screen which needs to be cleaned of any debris and rinsed off with fresh water before reinstalling it.

A majority of these pressure pumps use a switch which disengages the fresh water pump after it reaches a predetermined line pressure. If the fresh water pump continues to run continuously it may be a result of the following:

- A faulty internal pressure relief valve
- A faucet on board not turned off
- A broken line or loose line connection

It is recommended that the fresh water pressure pump switch be in the “off” position when leaving your boat to help prevent damage should a leak develop in the cold water system.

## NOTICE

AVOID COMPONENT DAMAGE!  
NEVER RUN THE FRESH WATER PUMP  
WITHOUT WATER IN THE FRESH WATER  
TANK AS PUMP IMPELLER DAMAGE  
MAY OCCUR.

## Using Fresh Water System With Tank Only



This potable water system features a deck mounted fill and vent. Ensure the water supply is drinkable before attempting to fill the potable water tank.

The tank levels can be monitored on the Garmin display when filling the tank.

Note the blue dots on the fresh water fill fitting. When finished filling the potable water tank screw in the plug until the 2 blue dots line up which indicate the fitting is completely closed. This will reduce the possibility to any foreign debris entering the potable water system.

*Note to periodically check the water fill vent located on the hull side for obstructions such as insect activity and debris.*

This approach is mainly used while cruising without the ability to draw from a marina or public water supply by attaching a garden hose to the city water valve. Also, use this approach when you are unsure of the purity and /or source of the water supply for drinking. The following information assumes there is a potable tank water supply.

1. Verify through the monitor panel that the fresh water tank is full by activating the upper portion of the toggle switch.

2. At the helm switch panel activate the fresh water system switch. This will energize the water pressure pump to send fresh water from the potable water tank through the cold water lines terminating at the various faucets and related components.

*Note not to run pressure water pump with system dry as water pump component damage may occur.*

3. Open a faucet. Water pressure should be present. Opening the faucet for a few seconds will purge any air in the system especially in cases where the fresh water tank has run out of water. When water is running at a faucet it is not unusual to hear the water pump activate as it is trying to build up the pressure required in the system. Soon after the faucet is turned off the fresh water pump sound will end indicating the fresh water system is now up to specified system pressure.



## CAUTION

PREVENT PROPERTY DAMAGE!  
DISCONNECT  
THE DOCK SIDE WATER INLET HOSE  
BEFORE LEAVING THE VESSEL.

## Fresh Water (Potable) Tank (Fill Procedure)

Note that the water valve (open position) is used to fill the potable (fresh water) tank. This is the only time the open or “on” position is used. The valve is located inside the head vanity cabinet door. Turn the water system manifold valve to the “on”(in line) position. With your hose connected to the city water faucet turn on the water.



When the fresh water tank is full (water exiting deck vent) or shown as a “full” display on the monitor panel disconnect water supply and be sure to turn the manifold valve to the “off” position.

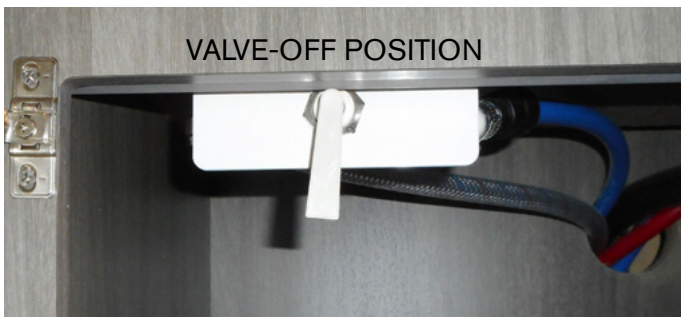

**Do not energize the fresh water pressure pump during the water tank fill procedure as system water will keep recirculating and the tank may not fill up.**

## Using Fresh Water System With City Water Valve

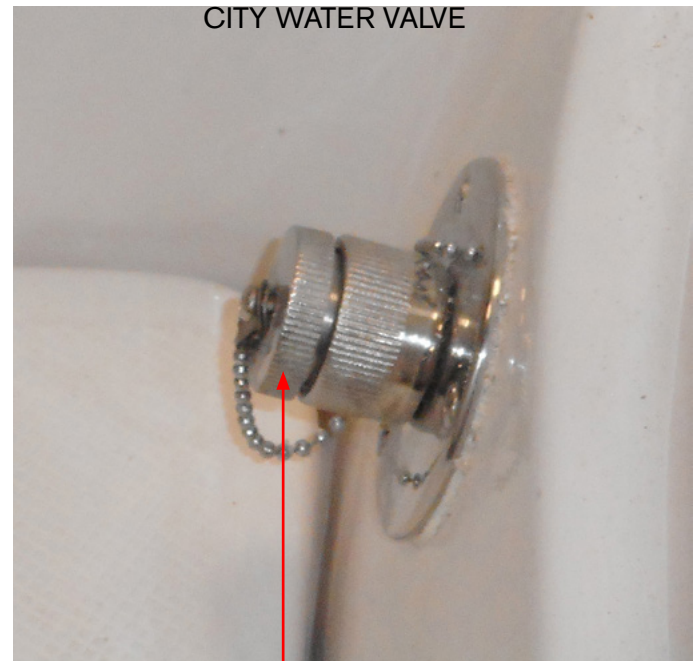

TURN COUNTERCLOCKWISE TO OPEN

Use this procedure when at the dock, mooring or ports where you know the purity of the water.

1. After verifying that the water supply is safe for drinking find the city water valve at aft transom. Remove the cap and inspect screen for debris.

2. Connect a water system approved garden hose to the city water valve. Turn on the water supply and check for leaks at the connection. White hoses are the ones normally rated for marine and RV application fresh water supply verses a regular garden hose which normally leave a rubber smell in the water supply.

3. Repeat steps 2 and 3 as indicated on the last column since the process at this point duplicates itself.

*Note that the city water valve protects vessel water system limiting incoming water pressure to 35 psi's.*

## Sanitizing Your Vessel Fresh Water System

It is recommended to sanitize your vessel fresh water system at least annually or more often when odors are detected.

1. Flush entire system thoroughly by allowing potable water to flow through it.
2. Drain system completely including water heater.
3. Fill entire system with a chlorine solution having a strength of at least 100 parts per million, and allow to stand for (1) hour. Shorter periods will require greater concentrations of chlorine solutions. See the table.  
As a rule of thumb quick reference without the use of the table to reach the recommended proportions use a quarter cup of household bleach for every 15 gallons of water the fresh water tank holds.
4. Drain chlorine solution from entire system.
5. Flush entire system thoroughly with potable water.
6. Fill system with potable water at the deck water fitting.

TABLE 1 – CHLORINE CONCENTRATIONS

Amount of chlorine compound required for 100 ppm solution

Solution (Gallons)	Chlorinated Lime 25% (ounces)	High Test Calcium Hypochlorite 70% (ounces)	Liquid Sodium Hypochlorite 1% (quarts)
5	0.3	0.1	0.2
10	0.6	0.2	0.4
15	0.9	0.3	0.6
20	1.2	0.4	0.8
30	1.8	0.6	1.2
50	3.0	1.0	2.0
100	6.0	2.0	4.0

## Winterizing Your Vessel Fresh Water System

*Note that In freezing climates make sure the fresh water system is winterized to prevent damage to hoses and components. Contact your Regal dealer since only special alcohol based products like “Winter Ban” are to be used in the system.*

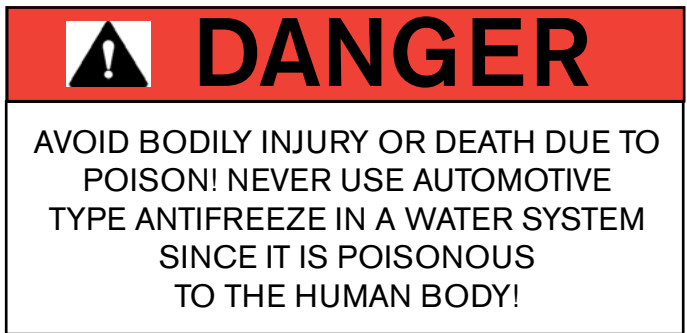



## Fresh Water System-Helpful Hints

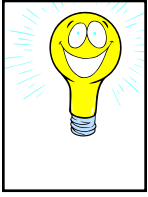

1. Fresh water pressure pump cycles on and off. Normally this type of action indicates a water leak in the system. Check all fresh water system related equipment on the deck, cabin, and engine compartment for leaks.

Do not forget wash down equipment including spigots. Look for puddled or dripping water.

2. Using potable water system the water pressure is weak. Check the fresh water pressure pump filter for debris. Also, make sure the potable water tank level is sufficient at the monitor panel.

3. Water at sink or shower is hammering and has air bubbles in it. Check for air leaks in the system along with low water levels in the potable water tank.

4. Water is backing up in the shower. Find the shower sump pump. If it is full of water even when running there may be a clog at the pump screen. Clean as needed.

5. There is no water at any of the fresh water related equipment such as faucets, showers and wash downs. Check to make sure the fresh water pressure pump breaker is activated. Also, check the fresh water monitor for tank levels.

6. The water system has a bad odor. Use the fresh water pressure pump to drain the fresh water system. Do not drink the water as it may be contaminated. Sanitize the water system.

7. No hot water. Check panel for popped tank element breaker. Reset as needed.

## Hot Water Heater

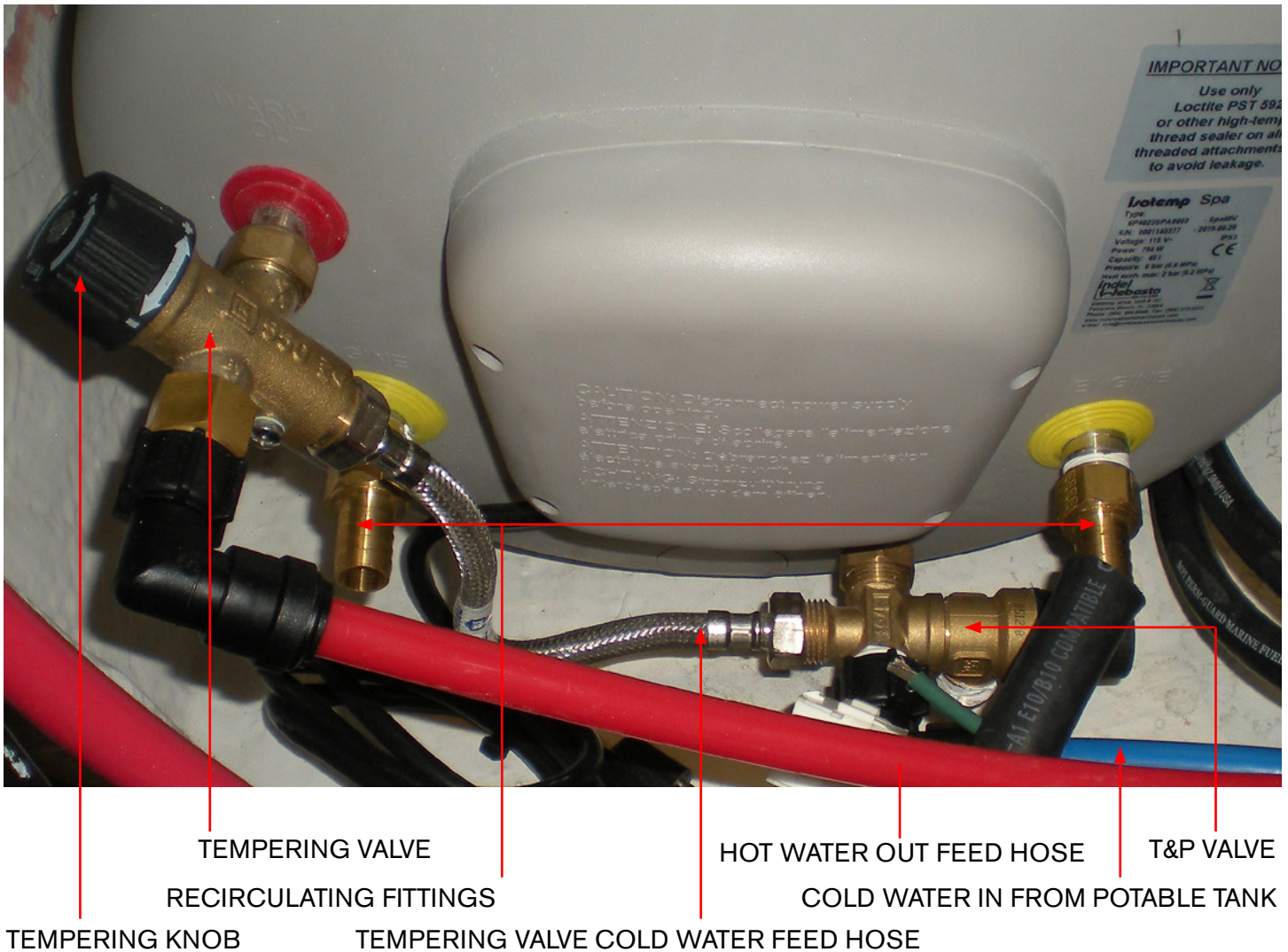

### Overview

The ship's water heater requires 120 Volts AC and the unit is located in the sump (bilge). It is a cylindrical shaped unit. The water heater breaker is located on the main ship's AC panel. The system features a 10.5 gallon capacity. The unit draws cold water from the fresh water tank and is heated by using dock side power or by the generator at sea. *Note that the water heater does not have a limited hot water capacity as conservation is needed onboard.*

### Operation

The photo above displays key players in the operation cycle of the hot water heater. The cold (blue) water line transports water from the fresh water tank to the aft tee on the water heater. Water runs through the tank via a tempering mechanism and exits the hot (red) line to the hot side of each sink and to the head shower mixing valve. *The recirculating fittings carry warm engine water to heat water heater at sea (Stern drive models only).*

The tempering valve is attached where the hot water exits the hot water heater for travel to the sinks and shower. You can identify the valve by the arrows on the knob on top. Make a note of the tempering valve setting and make sure it does not change. The purpose of the tempering valve is to regulate the outgoing heated water to a maximum of 125 degrees. If the output water is of a higher temperature than specified the valve mixes cold water to decrease outgoing warm water to safe levels through the stainless steel mesh hose.

There is an 750 watt element located inside the rear cover of the hot water heater. This is the component that heats up the water inside the water heater. The element requires that it be immersed in water.

There is a T & P valve similar to home water heaters. If the temperature reaches a pre-determined point in the tank the valve will open and let the over heated water will be exited overboard.

The hot water heater features a 316 gauge stainless steel inner liner with two thermostats; a temperature thermostat and a safety thermostat designed to trip in the event the tank is run dry. Both thermostats can be reset. Furthermore, there is a safety valve for easy winterizing of the unit.

For more information refer to your water heater operator's manual.



## WARNING

PREVENT INJURY OR DEATH  
FROM ELECTRIC SHOCK!  
NEVER REMOVE THE REAR COVER.  
CALL A SERVICE PROFESSIONAL  
AS HIGH VOLTAGE IS PRESENT.



## CAUTION

PREVENT HOT WATER HEATER DAMAGE!  
NEVER ACTIVATE THE BREAKER  
WHEN THE HOT WATER HEATER  
IS NOT COMPLETELY FULL OR  
THE ELEMENT MAY BE DAMAGED!

## Waste System (Typical)

### Overview

This section covers the main components of the standard waste system. Note that your vessel may have other components that are not covered in this section. Refer to the vendor owner's manual located in the owner's information packet or consult the internet or your closest Regal dealer for details regarding optional equipment.

The main standard components of the waste system are the toilet, holding tank, monitor panel along with hoses, fasteners and sea cocks. We will explore each in this section.

### Typical Head (Toilet) System

The onboard style head system features a vacuum toilet using minimal water. It normally features vitreous china bowls, minimal maintenance, easy cleaning and a wall switch keyboard.

The toilet is powered by 12 volt DC current and is controlled by a 30 amp breaker located at the ship's battery management panel.

Under normal conditions, the head system operates from the onboard freshwater tank. If dock side water is being used the toilets still draw water from the freshwater tank.

### A Few Notations About Marine Toilets

Only human waste and toilet paper should be put in the toilet. Never flush foreign materials such as paper towels, pre-moistened wipes, condoms, feminine hygiene products, dental floss or household garbage down the toilet.

- Always disconnect the dock side water system if boat is left unattended to avoid property damage due to leakage.
- Refill the toilet as soon as possible after emptying the bowl to prevent objectionable odors.
- Use only RV-Marine toilet tissues that disintegrate rapidly. Do not use household type tissues.
- If repairs are needed, use only a trained and qualified marine technician or electrician.





## Operating Vacuum Style Toilet (Typical)

To use toilet first make sure the 12 volt breaker is activated at the main control panel. Remember even though you are using dock side water the heads draw water via the fresh water system through the potable water tank.



The wall control switch is used to add water to the bowl and to flush the toilet. Select cycle information is noted here. For more complete information, refer to the toilet vendor information located in the information packet.

1. To add water (est. 17 ounces each cycle ) to the bowl press the add water button momentarily and release. The system prevents overfilling the bowl.

2. To flush the bowl press the flush button momentarily and release. The attached bowl motor will macerate the waste and flush it. The cycle ends with a small amount of water being added to the bowl to help prevent odors. This completes the minimal water usage flush cycle.

## Wall Control Panel Blue Backlighting Description:

- The holding tank icon in the lower right hand corner of the control panel is not lighted. Toilet system is off or not receiving power.
- The holding tank icon is normally green. This means the holding tank is less than full.
- The holding tank icon is red. The holding tank is full or near full with the flush lockout (prevents Flush operation when holding tank is full) activated.
- Tank icon flashes.
- Sleep mode (non-use for 8 hours) causes the lights to go out. Pushing the fill or flush button momentarily will return lighting cycle.

## Single Flush Override of Flush Lockout

1. If the holding tank is full the flush lockout cycle will not allow the bowl to be flushed and the flush button will be lighted red.
2. For emergency use only the flush button can be held for 8 seconds and a flush will occur. This can be accomplished because the full sensor connected to the holding tank is usually placed a bit below the actual full capacity of the tank. Flushing more than 5 times using the override feature may force waste into plumbing system. Regal is not responsible for damage to equipment, injury or death due to overflow of waste when the flush lockout is overridden.

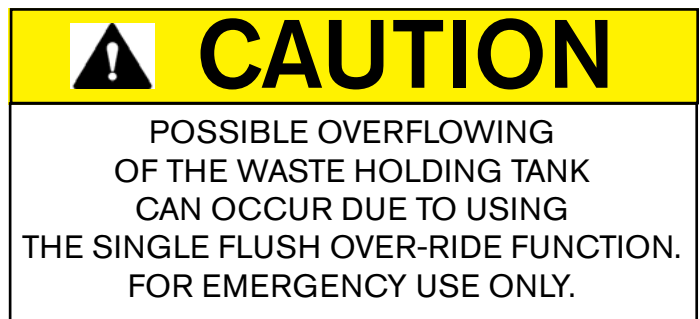

## Head Shower Notes



The head features a separate shower with an acrylic door and teak highlights. Teak is known as a hard wood with the ability to resist water infiltration in the marine environment. There is shelf storage on top of the shower for toiletries.

The shower mixer works similar to home components. Turn the handle to the left for warmer water and to the right for colder water. The shower head can be rotated as needed.

*Note that when showering the volume of the hot water heater is less than home water heaters; therefore it is recommended that water conservation measures be put in place.*

*Note that at sea the shower is using water from the potable water tank. At dock the tank is bypassed by connecting a hose to the city water valve to use marina water. Verify that the water is safe before attaching the hose.*

There is a tempering valve on the water heater to keep water temperature below 125 degrees. See the water heater information in chapter 4 and the technical chapter for further details.

The shower floor is covered with a teak grate. This enables water to drain out the drain and into the shower box where an automatic pump evacuates shower water.

To remove the grate simply pull up until it releases from the Velcro style fasteners. Periodically clean the drain screen of any accumulated debris. The grate can be rinsed with a garden hose and re-attached at the shower floor. Use a soft cloth and mild soap to clean the shower head walls. A squeegee can be used to clean the shower door sections. Rinse to remove residue.

An LED ceiling fixture provides additional light and is switched at the head wall.

## Head Shower Notes (Continued)

Behind the teak shower panel is a hot and cold fresh junction (water distribution panel). To access the panel see the drawing on the previous page. On the top of the teak shower bulkhead are screws that must be removed. With screws removed the panel can be lifted up from the 2 lower tabs and at that point will be free to move to the side to allow any maintenance work at the hose connections such as a possible leak.

*Note the red hoses are hot water and the blue hoses are cold water. Be sure to turn off the fresh water pump before disconnecting any components.*

A basic water system hose routing guide is shown below. It will assist you in identification of individual system hoses.

For further information refer to the technical chapter of this manual or contact your closest authorized Regal dealer or marine professional.

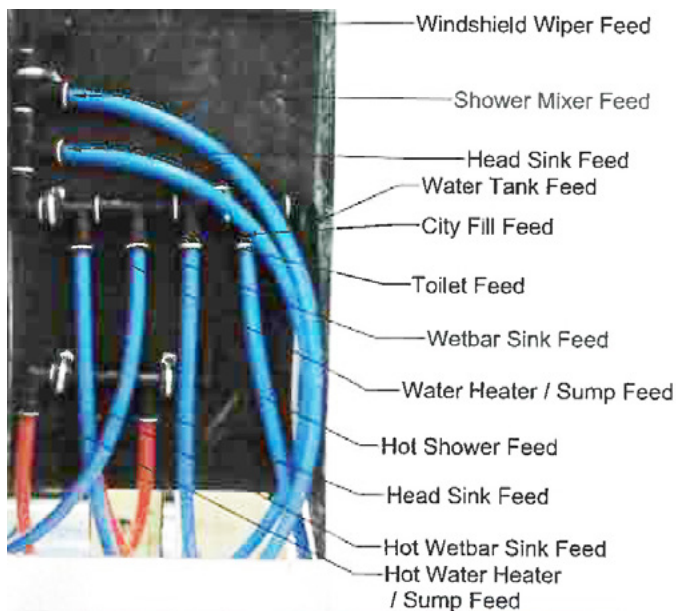

## Shower Collection Box-Typical

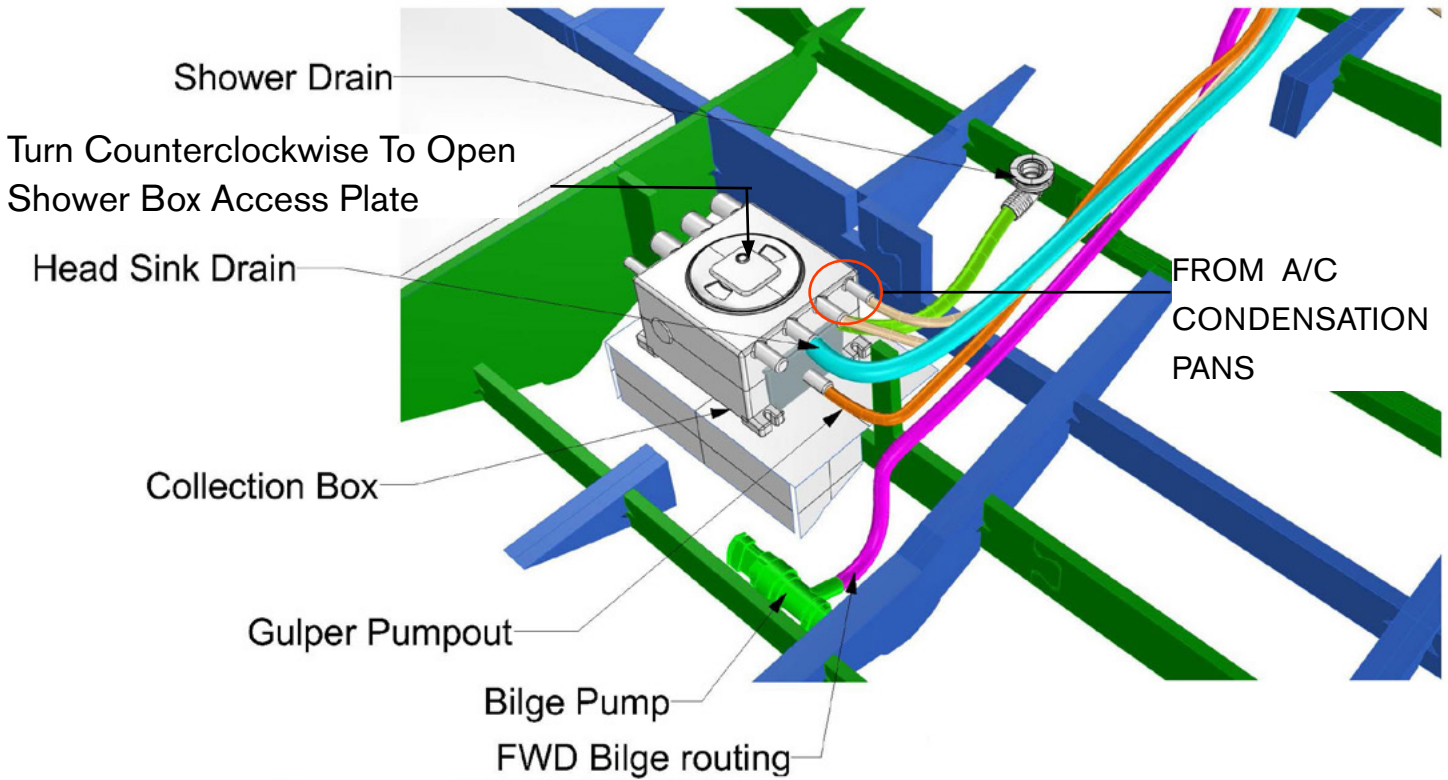

The shower collection box is a gathering and distribution point for water used in the vessel's sinks, shower, A/C system, and bilge pumps. This used water is pumped overboard traveling from the shower box to a hull side fitting.

Periodically check the shower pump inside the shower box for debris buildup at pump grate. The round center cover can be turned counterclockwise and removed to access the internal shower box components.

If odors emit from the shower box pour a 50/50 solution of bleach and water into it. The bilge pump will exit debris and contaminated water.



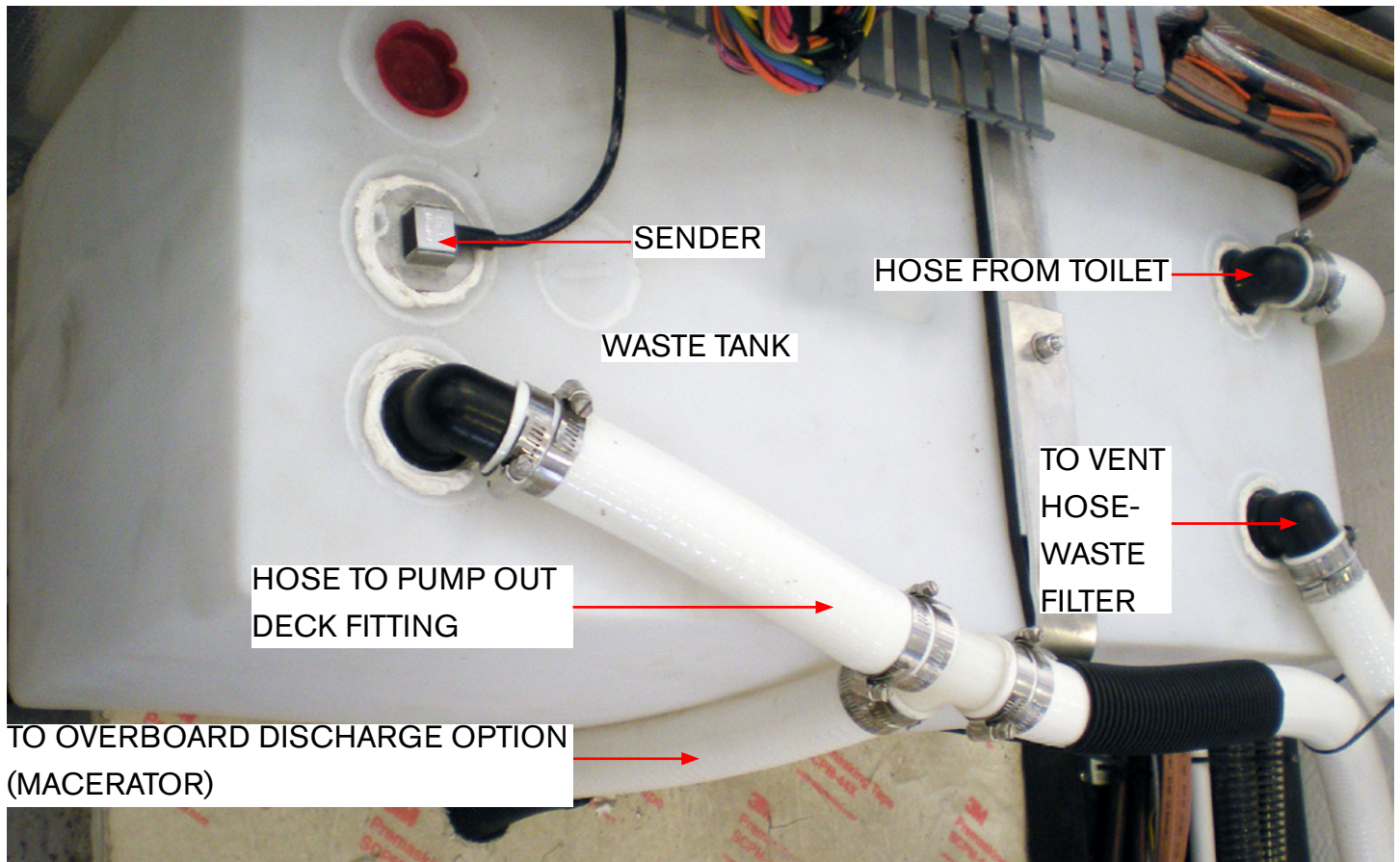

**Overview**

The waste water system on your vessel is located in the sump. The system features a pump-out fitting mounted on the deck labeled waste. System may vary from above photo.

The waste tank can be pumped out at select marine facilities. Normally a hose is attached to the deck waste fitting and the tank waste is then pumped into a dock side facility storage container.

After the pump out procedure it is always recommended to use a garden hose to rinse the pump out hose before securing the waste fitting. This will help keep residue and waste debris from building up in the inside of the waste hose.

Monitoring the waste tank level is important as you need to schedule pump out procedures as the waste tank levels reach a near full capacity. Always check levels before each cruise. There is a level sensor located in the waste tank. A signal travels through the Garmin chart plotter network extender (router) to the screen display. If you go to the home display and then to vessel display you will be able to monitor all tank capacities including the waste. Follow instructions below. Touch right side of display and sweep your finger to the left which will bring up the display boxes. Choose AV/Gauges and next choose Vessels which will display tank levels including the waste tank. Check the waste tank level on the chart plotter as the display should show empty after pumping.

## Overboard Discharge

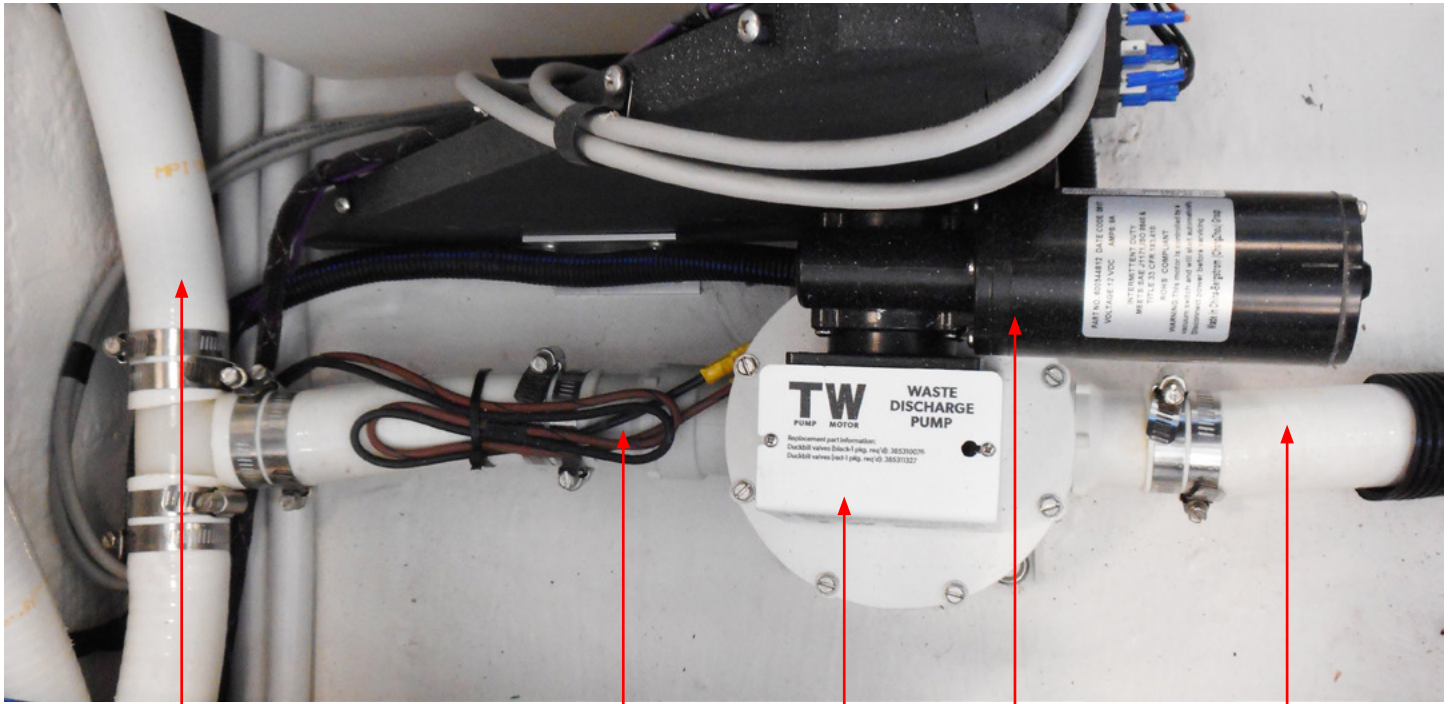

HOSE-TO DECK PUMP HOSE TO OVERBOARD MACERATOR HOSE TO SEA COCK  
OUT FITTING DISCHARGE PUMP DISCHARGE PUMP

### Macerator Operation (Typical)

As an option the vessel may be outfitted with an overboard discharge system including macerator. Waste will exit the hull through the macerator sea cock turned to the open position.

Check for all local and state laws regarding pumping overboard domestically before attempting to open the hull bottom sea cock as there may be stiff fines for pumping illegally. It is legal to pump overboard outside the United States 3 mile limit.

Open the overboard discharge (macerator) sea cock before attempting to pump waste overboard. To pump overboard note that there is a key switch at the cabin main DC panel. Turn the key to the "on" position. Next, press the macerator button on the battery activation panel (under aft seat) and the macerator pump will exit the ground up waste through the hull bottom sea cock.

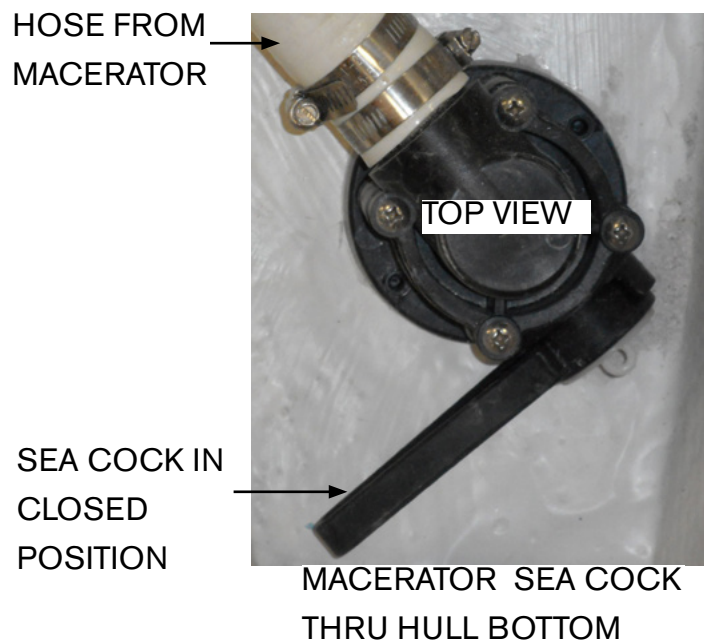



BATTERY ACTIVATION PANEL

The macerator breaker is 10 amps and is located at the DC distribution panel. After pumping out the sea cock handle must be turned to the off position and tie wrap added to further secure sea cock handle in closed position.

Periodically check all waste tank hose clamps for tightness, hoses for cuts and abrasion and that all components are fastened securely. Check for leaks.

## Vent Filter



The waste (holding) vent line tank filter is in-line between the holding tank vent and in this case a transom exit (exit hose missing here). As the holding tank fills up with waste it gives off odors. The vent filter controls odors while they travel out the aft portion of the transom. The filter uses the most efficient venturi design and refined charcoal to control waste odors. The waste filter is “customer friendly” as it is designed with a union at each end for quick changeability. The unions unscrew counter clockwise for serviceability. It is recommended to change the filter yearly, normally at the end of your boating season. Mark the change date on the filter or on your vessel maintenance calendar.

We recommend carrying an extra vent line waste filter onboard. For information on availability contact your closest Regal dealer or maine retail outlet.



## CO Detectors



Carbon monoxide known as CO is indeed the silent killer. It is a by-product of combustion. CO is invisible, tasteless, odorless and is produced by all combustion engines, heating and cooking appliances.

The most common forms of CO on board vessels are petrol engines/generators and if applicable, propane heating and cooking devices. Note: Even though your vessels propulsion system is diesel based follow the CO precautions. Also, remember that a vessel moored next to you may be a CO poison contributor.

Never disconnect a carbon monoxide detector. Periodically test the device using the procedures defined in the CO operator's manual. Remember that a slight amount of CO in the human body over several hours causes headaches, nausea and symptoms close to food poisoning, motion sickness or flu. High concentrations can be fatal quickly.

## How System Works

The CO detector uses a mini computer to measure and accumulate CO levels. Using the principle of "time weighted averaging" the detector monitors CO concentrations, temperature, humidity and time to calculate COHb levels. To explain COHb, our bodies prefer to absorb CO to oxygen and COHb is the absorbed ratio stated in a percent.

If the detector senses high levels of CO the alarm will sound in a few minutes. If lower levels are sensed, the detector will accumulate the data and sound an alarm when the appropriate level is reached. Read and understand the CO owner's manual in the information pouch.

The CO circuitry works to its best performance when continually activated plus it accords advanced warning when entering an area high in CO.

The CO detectors operate using 12 volt DC power and over current protection inside the battery management box in the engine compartment.

The test cycle should be activated frequently. Simply press the button. Refer to the CO detectors owner's manual for an explanation of the test cycle indicators.

Note that the green light will flash every 180 seconds which is normal.



When an alarm sounds take action immediately. The danger alarm indicator flashes red and the horn beeps 4 times, pauses and repeats the cycle. This indicates a rate of 10% COHb has been reached.

- a. Operate reset/silence button.
  
- b. Call your emergency services (911)
  
- c. Immediately move to fresh air. Do not re-enter the vessel. until emergency personnel have arrived, aired the vessel out and the alarm is in a normal condition.
  
- d. After following steps a-c and your alarm re-activates within a 24 hour period call a qualified technician to inspect the vessel. Note that the CO detector will clear when the CO concentration has dropped below 70 parts per million.

# Chapter 5

## Engine/Controls-Notes

### Introduction



Engine four stroke function is based on the following principles; fuel, compression, ignition, and exhaust. All propulsion engines offered on the 36 use these principals including gas or outboard propulsion. Also, optional gas and diesel generators are four stoke.

The proper ratio of fuel and air must be drawn into the engine's cylinders in order to be compressed by the pistons and ignited by spark or compression, the force of which pushes the piston back down providing the energy used to turn your propeller before the engine kicks into the exhaust stage where it expels the by-products.

If any of these four functions fail, so does the engine itself. To learn more about engine functions, systems, and maintenance items refer to the engine manufacturer's owner's manual found as part of your owner's information packet.

In addition, be diligent about referring to the information packet as engine and drive propulsion manuals are found there along with most on board component manuals, parts information, and product warranty disclosures. These documents usually include repair station information along with key internet and phone contact options. It is highly recommended that the operator of the craft share the owner's information packet documents with the crew should they be required to access for troubleshooting, etc. should the skipper be unable to assist in these needs. **Bottom line is be prepared!!!**

# Engine (Stern Drive) & Controls

## Regal Owner's Manual

Your Regal owner's manual covers *basic* operations of the propulsion systems as they relate to the running of the vessel but it should not be thought of as a shop manual. Included is basic maintenance regarding gas and diesel propulsion systems along with troubleshooting guides and technical drawings that cover the basic boat systems.

Following in this section are basic engine checks of the engine and drive lubrication systems, power steering, cooling, and trim system fluids.

Components used on multiple propulsion systems available on this model such as the battery management panel are found in the systems chapter since the information is shared by gas, diesel, and outboard models.

For more specific information refer to your Volvo engine operator's manual.



VOLVO GAS ENGINE SHOWN ABOVE

## Volvo Stern Drive Engine Owner's Manual

It is important that you read your stern drive engine manual carefully and become completely familiar with the operation as well as necessary maintenance on the engine and propulsion systems before operating the vessel. Pay careful attention to the sections on winterization if you live in freezing climates. Extensive damage can result if winterization procedures are not followed properly.

Contact your closest authorized Regal dealer for information regarding technical issues and parts. For more specific information refer to your gas or diesel Volvo operator's manual.



## WARNING

PREVENT INJURY OR DEATH!  
READ ALL MANUFACTURER'S STERN DRIVE  
ENGINE AND PROPULSION OWNER'S  
MANUALS BEFORE OPERATING  
YOUR VESSEL.



## WARNING

PREVENT INJURY OR DEATH!  
ALWAYS STOP THE ENGINE(S)  
BEFORE PERFORMING  
ANY ENGINE MAINTENANCE!

## Pre-Checklist (Before Starting Engines)

Every engine option may require different checks before each use, but a general engine checklist is included here as a guide.

- Check crankcase engine and out drive oil levels. Use engine manufacturer's specifications and recommendations.
- Check power steering fluid at reservoir.
- Check power trim fluid at trim pump.
- Check power trim for operation.
- Check control lever clip and safety lanyard for functionality (if applicable).
- Check fuel gauge on Garmin screen and ensure the level is sufficient for the trip with a 1/3 reserve.

## Starting Engines- Earlier (Volvo System)

Below are basic starting instructions for your vessel using the earlier Volvo system. Refer to the Volvo engine operator's manual for more detailed information on gas and diesel starting procedures.

1. Start all blowers. Run for at least 5 minutes before attempting to start the engines.
2. On earlier systems ensure you press the E-key "on" button to provide power to the batteries and engine ignition panel.
3. On earlier systems make sure the remote control station is activated in the neutral position.
4. On earlier systems depress the "ignition" switch for each engine which will show a green light.
5. On earlier systems depress the port start/stop switch on the Volvo panel until the engine starts. Repeat with the starboard start/stop switch until the engine starts.
6. Allow engines to idle and reach normal operating temperatures. Advance the throttle only button as necessary. Monitor Garmin engine gauge display.



## Engine Systems

### Engine Cooling System

Your typical engine normally utilizes a raw water system for cooling the engine with intakes on the drive shaft housing. It is important that this system continues to run unobstructed at all times to avoid hazardous situations and to ensure a safe voyage. Raw water is drawn up into the vertical drive shaft housing through pick-up feeds in the housing.

Periodically, the coolant system's impeller and water pump should be inspected for debris, damage, or excessive wear due to water chemistry factors such as mineral and/or silt conditions.

If the temperature gauge starts yielding abnormal readings, it may become necessary to look at or replace the engine thermostat after determining whether it is functioning properly.

The thermostat reads the temperature of coolant and determines whether to open or close a valve to allow warm sea water to pass into the exhaust manifolds. The thermostat may recirculate hot coolant for the purposes of reaching standard operating temperatures.

Water passes through an engine mounted thermostat which controls how much water circulates through the cylinder head and engine water passages. The cool water absorbs heat produced by the engine, before being emitted via the coolant exhaust system.

Select engine types use a closed water system featuring a radiator like heat exchanger to keep the engine water at optimum temperature. These systems feature anti-freeze in the closed system side which requires periodic maintenance.

See your engine manual for maintenance schedules.

### Freshwater Flushing Attachment

Your engine features a fresh water flushing system. After linking up to a fresh water hose at the flush port, water can be pumped through the engine's raw water cooling system to flush out all salt and debris that may be left behind.

Normally the flush fitting is found on the engine behind the alternator or at the port side of the transom shield. See manufacturers operator's manual for visual and more specific information.

*Note to always remove the ignition keys while connecting up the flush device.*

After the connection is opened a garden hose is connected to the fitting. Always tighten all connections. Verify that the hose will deliver the correct amount of water pressure (see engine owner's manual for water pressure specification). Turn on the water and check for leaks. The engine can be flushed as it is run at neutral idle speeds. It is best to connect the flushing system up when the engine is warm since the thermostat is open at this time to allow water to circulate through the entire head rather than bypassing the cylinder head areas. Do not run the engine over idle while using the flushing device as engine damage may occur.

*Note never to shift into gear while the engine is being flushed.*



## WARNING

PREVENT INJURY OR DEATH FROM  
PROPELLER BLADES!  
NEVER SHIFT REMOTE CONTROL INTO  
GEAR WHILE FLUSHING THE ENGINE!

## Engine Electrical System

Your engine utilizes a great deal of electronic equipment. Some equipment sends signals between the engine and the Garmin, while other systems set off alarms, and still others are used by the engine to generate a spark and ignite the fuel. The helm mounted battery management panel controls DC electrical power distribution to the boat systems through the house and engine cranking battery systems.

To regularly maintain your DC electrical system, inspect the battery charge before each trip. Test all gauges and control equipment prior to departure, and replace as necessary. Spark plugs should be replaced according to your engine owner's manual maintenance schedule.

## Gauge Electrical Signals

Your engine transmits signals by electrical harnesses to individual components through the use of NMEA 2000 connections and a "backbone system". A single Garmin 22" screen plotter or dual Garmin 16" screen plotters display the engine functions including fuel and depth readings.

## Alarms

When a malfunction with your engine occurs, the Garmin plotter alerts the skipper of a problem. Common engine problems include overheating, low oil pressure, or a miscommunication with equipment. Learn the alarm system faults that apply to your engine by consulting your engine manufacturer's owner's manual at the fault code register page.



# CAUTION

AVOID ENGINE DAMAGE OR FAILURE!  
DISCONTINUE ENGINE OPERATION  
AFTER AN ALARM HAS SOUNDED.  
ADDRESS MALFUNCTION BEFORE  
RESTARTING ENGINE.

## Spark Plugs

The spark plugs are the piece of equipment that generates ignition or spark. As electrical potential builds on one side of the gap based upon the energy distributed by the distributor, the potential eventually grows large enough to cause the electric current to jump the gap on the spark plug. This spark is what ignites the compressed fuel generating a controlled explosion that will power the piston down and deliver power to the drive shaft.

## Alternator

Under normal circumstances, the starter battery system would wear down after being used so often to generate a spark for the engines. This isn't an ideal setup because a strong battery is needed for continual operation. A weak battery does no good out on the water. Each engine features a 105 amp hour alternator to recharge the batteries while the engines are running.

However, in an effort to conserve battery life, the battery switch should still be turned off after every trip and turned on at the start of every trip. This limits the drain on the battery while the boat is not in use. As standard equipment a battery charging system (50 amps) charges batteries while the dock side cord is hooked up and engines are off.

## Batteries

Never disconnect a battery cable with the engine running as spontaneous charging system damage will occur. On wet cell batteries periodically check for correct electrolyte cell level and fill as needed only with distilled water.

## Engine Exhaust System

Your engine expels the by-products of the engine operation through an exhaust system, just like cars do. In boats however, this exhaust system mixes the debris left over after the power stroke of the engine with hot water expelled after cooling the engine.

Basically the exhaust flows through the exhaust manifolds before expelling the exhaust through the vertical drive housing.

## Engine Fuel System

Refer to the system chapter of this manual for fuel system specifics. Read & follow warnings below:



### **WARNING**

NEVER USE E-15 OR E-85 ALCOHOL ENHANCED FUEL AS IT CAN LEAD TO DETERIORATION OF THE FUEL SYSTEM COMPONENTS. THIS CAN RESULT IN FIRE AND POSSIBLE EXPLOSION ALONG WITH VOIDING ENGINE WARRANTY.



### **WARNING**

GASOLINE VAPORS CAN EXPLODE! BEFORE STARTING ENGINE. PERFORM SNIFF TEST AND CHECK BILGE FOR GASOLINE LEAKS OR VAPORS.



### **WARNING**

PREVENT INJURY OR DEATH DUE TO FIRE OR EXPLOSION! RUN BLOWER AT LEAST 4 MINUTES BEFORE STARTING ENGINES. RUN BLOWER BELOW CRUISING SPEEDS.

## Gasoline Octane Requirements

For stern drive engines use **unleaded** gasoline with the following minimum octane rating:

- In the U.S.A: (R+M)/2 (AKI) - 87
- Outside U.S.A.: (RON) - 90

*Note that mid-grade and premium unleaded fuels may provide increased performance and fuel system protection due to the addition of injector cleaners and other additives as used in fuel injected engines.*

*Note that engine damage caused by lower octane gasoline than specified above is not covered by the warranty.*

*Note that leaded gasoline is found in certain markets especially at select gas stations. Leaded gasoline will damage the catalysts and is not to be used in engines with catalytic convertors. Failure of catalysts due to improper fuel is not covered by warranty.*

## Engine Break-In All Models

All propulsion systems require a pre-determined “break in” period. During this time the engine should not be run at a full load condition for extended periods. Various engine load and speed conditions assist the internal engine parts such as bearings, valves and piston rings to “seat” properly which will help ensure a longer engine life. See operator’s manual for further information.

During the “break in” period it is necessary to check the engine oil more frequently since it is normal that the engine will use more oil. If engine oil is required be sure to check the engine manual for proper grade and viscosity.

Check the maintenance schedule in your engine owner’s manual and contact your Regal yacht dealer to set up the first maintenance inspection. Normally the engine oil, filters, and drive oil inspections and maintenance are performed during this inspection along with other items.



## Reference Drawing- Typical Gas Engine Maintenance & Service Component Locations

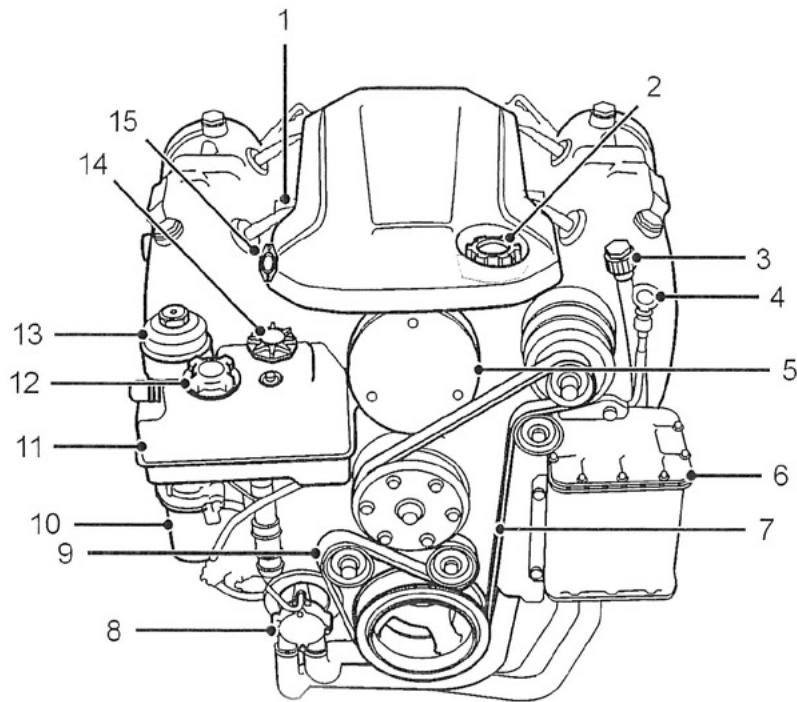

- |   |                      |    |                                      |
|---|----------------------|----|--------------------------------------|
| 1 | Fuse and Relay Box   | 8  | Seawater Pump                        |
| 2 | Oil Fill Cap         | 9  | Belt Tensioner                       |
| 3 | Engine Flush Fitting | 10 | Fuel Filter                          |
| 4 | Engine Oil Dipstick  | 11 | Coolant Expansion Tank               |
| 5 | Flame Arrestor       | 12 | Coolant Fill Cap                     |
| 6 | Heat Exchanger       | 13 | Engine Oil Filter                    |
| 7 | Serpentine Belt      | 14 | Power Steering Dipstick              |
|   |                      | 15 | Auxiliary Stop Button <sup>(4)</sup> |

## Engine/Drive Lubrication System-Oil Change



# CAUTION

AVOID ENGINE DAMAGE OR FAILURE!  
CHECK ENGINE/DRIVE OIL LEVELS  
BEFORE EACH OUTING. IF LOW ADD  
APPROPRIATE OIL TYPE AND QUANTITY.

### Engine Lubrication System-Adding Oil/Change

Be sure to read the engine operator's manual regarding engine oil change recommendations. Be sure to follow the Volvo recommended oil type and viscosity. Note that if Volvo oil is not available an alternative oil can be used as specified in the Volvo operator's manual (oil approved for catalyst equipped engines). Be sure to change the oil filter each time the engine oil is changed. The engine oil change is an important factor in obtaining engine longevity since impurities enter the crankcase over time through the combustion process and build up in the engine oil.

Never exceed a 12 month period between oil changes especially with diesel power since sulfur tends to enter the lubrication system through the fuel combustion process over a period of time.

After changing oil always check level with dipstick (see drawing). Add approved oil type and quantity as needed. Wipe the dipstick with a clean cloth. Recheck oil level again. Make sure the oil level is between mark A & B on the dipstick (C). Remember not to overfill the engine crankcase with oil as the engine requires a precise oil level to operate at top efficiency.

Overfilling can result in loss of power, air in the oil, high operating temperatures, and overall reduced engine longevity.

Oil capacity for later V8's is 7.5 U.S. quarts (7.1L) which includes an oil filter change. The oil filter used is a replaceable paper element filter type. Note the O ring as part of the oil filter replacement kit. Coat O ring with fresh engine oil before installing. See the engine reference drawing for oil filter location. Always dispose old filter element in an environmentally friendly way.

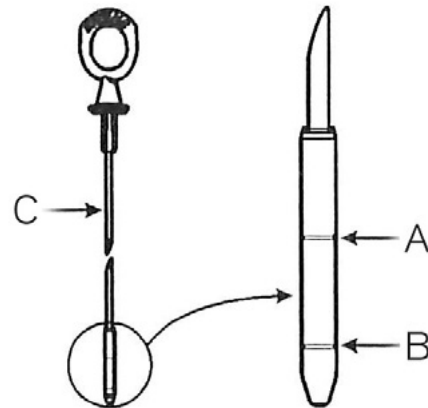

\*Courtesy of Volvo Penta

## Drive Lubrication System-Adding Oil/Change

The stern drive oil protects the gears and bearings in the vertical drive and gearcase. Like the engine drive oil needs to be checked on a periodic basis preferably before each outing. Do not check if vessel is in the water. Make sure you use the correct type and amount per your engine manual.

Remove the dipstick from the top of the drive unit as shown in the drawing. Note the flat section (A) on the dipstick. This is the top and bottom full range for the drive unit. If it is down from the top of the high mark add oil through the top of the drive unit in small amounts. Wipe dipstick with a clean cloth and reinstall. Recheck for proper level.

If unit is too high, remove oil from the drive until the level is correct. Check dipstick O ring for any gouges or signs of cracking. Re-install dipstick and torque to 48-72 inch pounds. See the service and maintenance manual or contact your closest authorized Regal yacht dealer or authorized Volvo repair facility for further information.

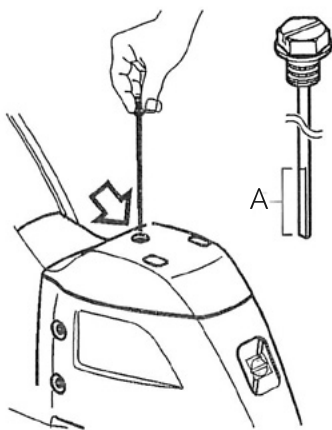

\*Courtesy of Volvo Penta

## Drive Oil Troubleshooting

When checking for drive oil levels pay close attention to the color of the drive oil on the dipstick. Fresh oil will be amber in color. As drive oil ages it normally darkens in color due to heat and chemical reactions between the internal metal parts such as gears and bearings. Normally a darker color should alert the operator to the need for changing the drive oil.

*Note that on Ocean drives only after changing the drive oil there is a drive sensor that needs to be reset or an alarm will sound. Refer to the manufacturer's operating manual for more information.*

Another item to monitor with the drive oil dipstick is to look for a milky drive oil color. A milky consistency indicates there is water mixed in with the oil. Normally this is caused by a seal failure at the prop shaft or more unlikely the intermediate housing. Fish line is one item that gets wrapped around the prop shaft in front of the propellers and can eventually cut the seals due to the prop shaft turning around the line. Removing the propellers and a visual inspection may show the fish line around the prop shaft. In any case do not continue to run the propulsion unit with water in the oil as it could cause internal bearing failure due to overheating. Call your closest authorized Regal yacht dealer for assistance.

Lastly, monitor the drive oil dipstick for drive oil that appears to contain metal flakes or small metal particles. They appear shiny in the oil with day light. Causes of excessive metal particles are premature gear or bearing wear due to overheating. Discontinue use and contact your Regal dealer.

## Power Steering-Checking/Adding Fluid

The power steering system utilizes a fluid used in the internal hoses and cylinder to assist in turning the stern drive as the steering wheel is rotated. This is another one of those checks which is best to be preformed before each outing.

Find the power steering reservoir on the engine. See drawing here as it displays the major parts including the power steering dipstick. Unscrew the power steering dipstick by turning it counterclockwise. Fluid level on dipstick (B) should be in the (A) range as shown in the drawing. Add Volvo Trim/Tilt and Power Steering Fluid to the reservoir. Wipe the dipstick with a clean towel, reinstall, and check fluid level to the (A) requirement. Do not overfill the reservoir. Ensure that foreign particles do not enter the reservoir when checking or filling it.

Note that in lieu of Volvo Penta fluid use Dextron 2 or higher such as Dextron 3. Never use other brands, types, or viscosities of fluids not approved since they may cause steering problems and/or component damage.

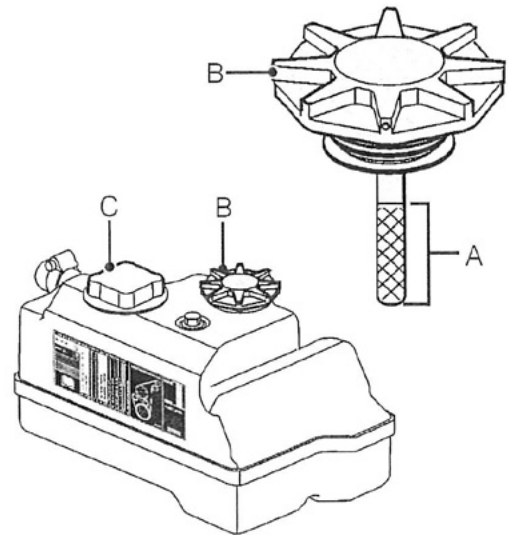

\*Courtesy of Volvo Penta



## Fresh Water System-Checking/Adding Coolant

The fresh water coolant needs to be checked before each outing. Read and understand the following fresh water coolant system warnings:



### WARNING

PREVENT INJURY DUE TO HOT LIQUIDS!  
DO NOT OPEN THE COOLANT CAP  
WHEN THE ENGINE IS HOT AS STEAM OR  
HOT ANTI-FREEZE COULD CAUSE BURNS!



### WARNING

PREVENT INJURY OR DEATH!  
ETHYLENE GLYCOL COOLANT IS  
POISONOUS TO HUMANS AND ANIMALS  
IF INGESTED. DISPOSE OF ALL COOLANT  
IN A ENVIRONMENTALLY FRIENDLY WAY!



### CAUTION

AVOID EYE IRRITANT POTENTIAL!  
WEAR EYE PROTECTION  
WHEN WORKING WITH COOLANT.  
WEAR GLOVES & WASH HANDS OFTEN!

Note that the engine coolant reservoir uses a special yellow VCS Volvo coolant. Never mix coolant types such as green or pink anti-freeze with the more advanced type yellow VCS. This yellow VCS coolant adds more corrosion protection and prevents clogging for newer engines using a variety of metal alloys. VCS is a silicate-free coolant based on OAT (organic acid technology).

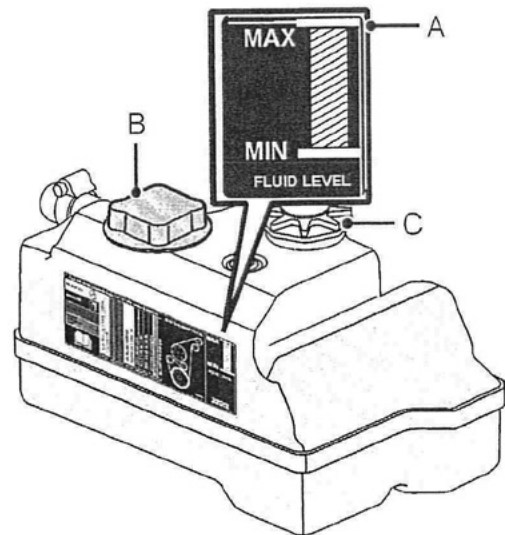

\*Courtesy of Volvo Penta

Overall, the inhibitors provide additional protection against corrosion, cavitation, and deposits.

*Note that that VCS still contains glycol to prevent freezing in cold climates.*

Monitor the visual minimum and maximum levels on the side of the reservoir. Add VCS coolant to the reservoir by removing cap B (do not remove cap C as it is for power steering fluid). Fill the reservoir using a funnel. Make sure you do not overfill the reservoir beyond the MAX. level A.

Obtain VCS coolant from an authorized Regal or Volvo dealer. It is available in a pre-mixed container or if using full strength anti-freeze be sure to dilute to 50/50 mix of anti-freeze and distilled water. If refilling entire cooling system refer to coolant capacity guidelines in the Volvo operator's manual.

## Fuel System-Replacing Water Separator Filter

Open the engine hatch completely to provide accessibility and to ventilate the engine compartment. Remove keys from ignition and follow label below.

To change the engine mounted water separator filter the following items are needed; new fuel filter, wrench to remove and install filter, clean engine oil, along with container/clean rags.

Install a container under the fuel filter and position in place using clean rags. Wrap the filter wrench around the fuel filter and turn counterclockwise to break the filter loose. Turn until filter is free and carefully dump the filter contents into the container outside of the engine compartment.

Examine fuel for small droplets in the bottom of the container which normally end up to be water. Also, check for dark foreign particles in the fuel which could originate from where the fuel was purchased. Always obtain your fuel from a facility that sells large amounts of fuel as chances of problems existing from older fuel batches is lowered.

Lubricate the gasket or O ring on the new fuel filter. Screw the new filter on to the pump assembly. Hand tighten. Do not overtighten with a wrench. Clean up any spilled fuel. Discard container and rags in an environmentally friendly fashion.

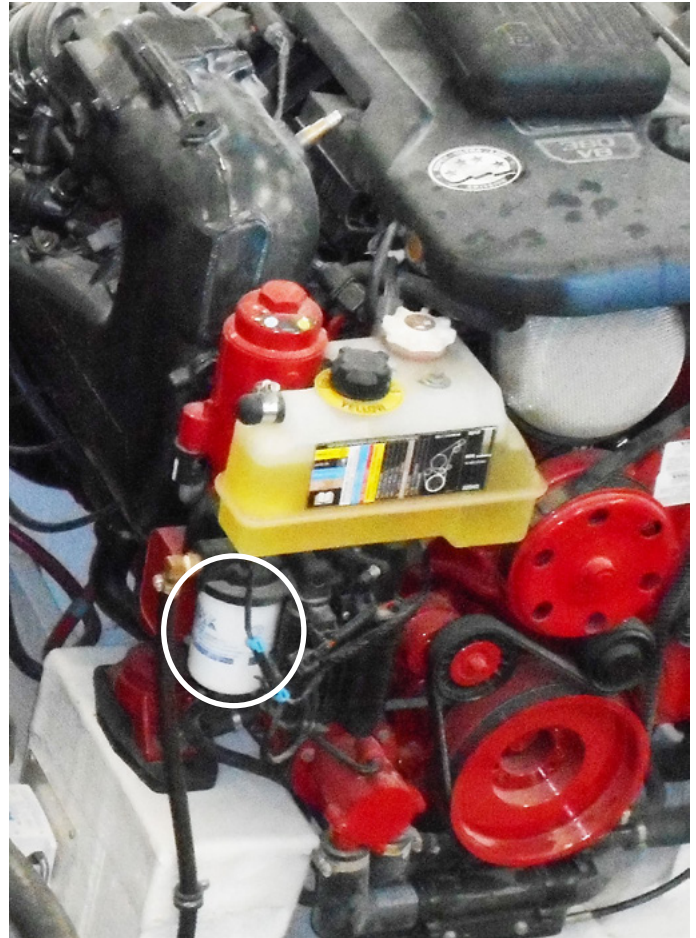

**It is recommended to run the blower for at least 4 minutes to vent engine space and below cruising speeds.** Start the engine and check for leaks especially around the filter area. Read and understand the label below.



# DANGER

**AVOID BODILY INJURY OR DEATH DUE TO EXPLOSION OR FIRE!  
IF YOU DETECT ANY FUEL LEAKAGE TURN OFF THE ENGINE IMMEDIATELY.  
CORRECT ANY LEAKAGE!**

## Helm Controls

### Digital Instrumentation

The Regal yacht helm station (dash) is equipped with a chart plotter system which monitors the condition of the gas stern drive propulsion components. This digital system replaces individual analog propulsion gauges. Propulsion signals are read digitally and sent to the plotter for display and monitoring through a system called NMEA 2000. Close observation of the plotter system is the responsibility of the captain while cruising. Periodically scan the screen for all the key propulsion readings. The plotter system also provides GPS and navigational information for components such as radar (if installed) and monitors the Fusion® entertainment system.

Other standard and optional dash instruments called displays present digital information on various systems. Become familiar with all the displays and their functions through their normal operating specifications as outlined in this manual and the Volvo engine operation manual. Display options may include a windlass remote, Seakeeper panel, Flir thermal camera, Fusion Apollo™ entertainment, VHF marine radio panel, battery management display, gas vapor detector, trim tab control and various others. We will touch on select displays in this manual. Refer to the manufacturer's manual for more specific information.

After educating yourself in the functionality of the chart plotter be sure to train another person as the skipper's backup. This person should know how to read the screen and how to recognize and respond to system "fault" codes should they occur.



## Helm Systems/Gas Stern Drive (Typical Overview)

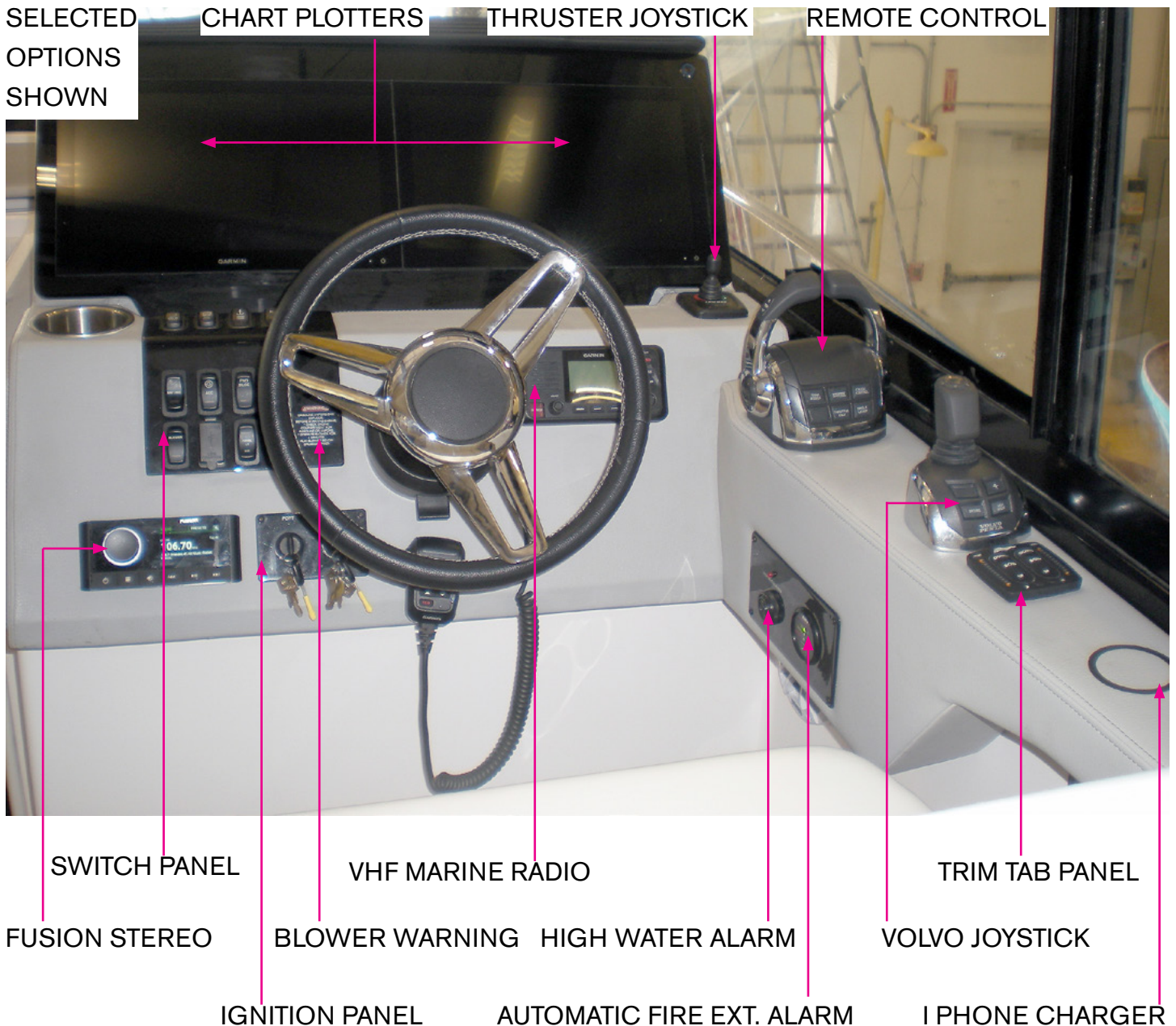

### Helm Overview

The helm station is equipped with the ability to monitor engine functions through a Garmin chart plotter. Close observation of the digital display is recommended throughout the trip as you can split the screen to accommodate GPS functions along with monitoring basic engine systems including fuel usage and hours for maintenance cycles.

*Note that select items above may be optional components and may not be installed on your vessel.*

The Garmin chartplotter system is available as a single or dual screen component.

*Note that with the battery switches at the battery activation panel in the "off" position, there is no power to the helm and the ignition switch.*

Select components are protected by the main DC distribution panel located in the cabin. Refer to the systems chapter for additional information or contact your closest authorized Regal dealer.



## Garmin Engine Monitoring Display



Typical Display Shown

A Garmin single or dual chartplotter is standard equipment on your outboard vessel. The unit displays many GPS features along with the ability to monitor engine system functions including tachometer; engine revolutions per minute (rpm's), GPS speed, voltage, fuel flow rate, trim, and temperature along with tracking engine hours.

Fusion uses its own display screen on the chartplotter for audio controls on the vessel.

Note that the Garmin and Fusion circuitry use individual DC sources to power up the system. The key switch does not power up these 2 systems.

1. To power up the Garmin plotter ensure the house main battery button is pressed on the battery activation panel. Then press the on button located at the upper chartplotter display.

2. The function AV/Gauges,Controls will appear as one of the choice boxes. Press the box. Another screen with engine will appear.

3. Press the engine box and the engine gauge displays will appear (oil pressure is engine code driven only).

4. The Garmin plotter provides setting up very personalized displays such as the Favorites one shown below. Refer to the Garmin owner's manual for further information.



## Helm Switch Panel



### Helm Seat

This switch controls the forward and backward helm seat movement.

### Sun Roof

This switch controls the hard top sun roof forward and aft movement. It is a good idea to close the sun roof when leaving the vessel for extended periods and during rough sea conditions.

### Windlass

This switch supplies current to the windlass up and down switch mounted at the anchor rope locker. Also, it activates the windlass remote control.

### Horn

This momentary switch controls the electric horn at the hardtop. Make sure the horn is tested before each outing.

## Nav/Anc

This on/off/on switch energizes the center bow red/green navigation light and stern light as a standard configuration as the top portion of the switch is pressed. When the bottom portion of the switch is activated the anchor light all-around portion illuminates on the hard top. Check navigation lights before each outing to ensure the bulbs are working properly and the wiring circuitry is delivering current to the light fixture.

## Acc

This switch controls any after market component that may be added to the vessel. Always ensure that the amperage draw of the component is safely within the amperage limits of the switch circuit.

## Fwd. Bilge

This switch covers the forward bilge pump. This pump is located below the cabin steps under the floor hatch. It is close to the shower box. Periodically check the pump float mechanism to ensure it is activating properly and the pump grate for debris.

## Aft Bilge

This switch controls the aft bilge pump which is located below the Lazarette compartment storage hatch in the aft bilge. Periodically check the float mechanism to ensure it is activating properly and the pump grate for debris.

## Blower

This switch controls the DC powered ventilation blower at the starboard hull side of the bilge. The powered ventilation system is used on gas stern drive engines and generators. It removes any fuel vapors via hoses installed in the lower third of the bilge. Always run the blower for at least 4 minutes before starting the generator. Activate blower during generator usage.

***Note to read and understand the blower warning label on the lower right side of the switch panel.***



## USB Charging Port

This charging port features dual USB ports (4.8 amps) and a water resistant dust cover. This component features intelligent device recognition for rapid charging of phones, tablets, and other mobile devices. When not in use snap the protective cover in place to protect the ports from moisture and corrosion.

## Panel LT

This switch controls the helm station lighting. When you depress and hold the BRIGHT segment of the switch the helm lighting will ramp up the brightness. When desired light level is reached release the switch. Depress the lower DIM segment and hold to dim the helm lighting to a desired level.

## Windshield Wiper

This switch controls the windshield wiper and wash systems. Note the switch is “off” when the handle is in the down position.

As the handle is moved up a series of wiper speed positions are available. The highest speed position is found at the top of the switch.

To operate the wash system simply press on the wash icon on the switch while operating the wiper and water will eject from the wiper frame on to the glass.

Note not to run the windshield wiper over a dry windshield as debris could cause scratching of the tempered windshield glass.

*Note that select switches may represent optional equipment not installed on your vessel.*

## Volvo EVC Remote Control

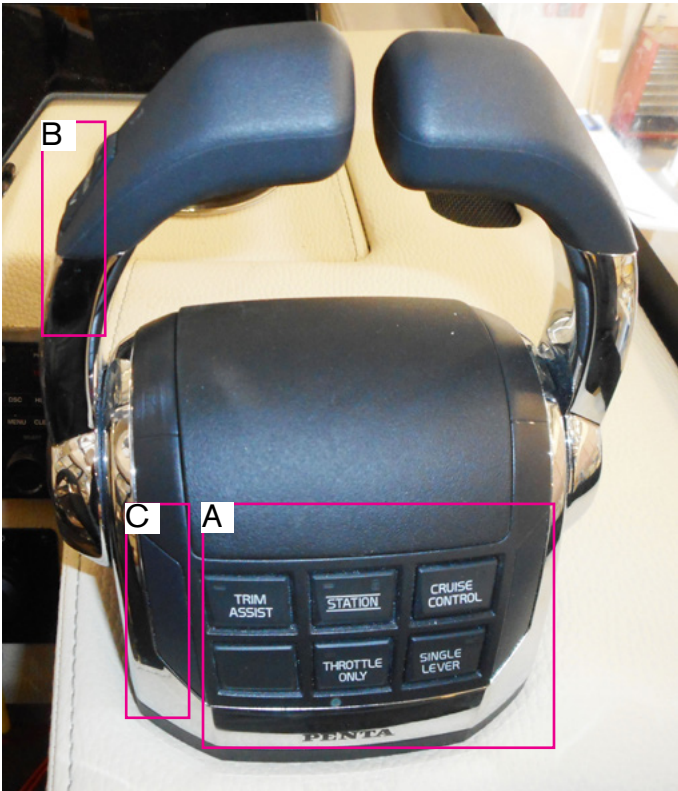

TYPICAL STERN DRIVE REMOTE CONTROL

The following is a description of functions as seen in zone **A** shown above. Refer to the engine manual for more specific operational information or contact an authorized Regal yacht dealer.

**Trim Assist-** The Power Trim Assistant button adjusts the trim angle automatically according to engine speed (rpm).

**Station-** This button is lighted when the helm station is activated.

**Cruise Control-** when this button is pressed it permits the operator to fine tune engine speed by increasing or decreasing engine rpm with the button on the forward side of the control. Use the + or - on the button to increase or decrease engine rpm.

**Throttle Only button-** when pressed it disconnects the shift function. At this point the control lever only effects the engine speed.

**Single Engine-** Pressing this button permits the operator to control both engines with one lever.

At Zone **B** the following function is indicated:

**Trim-** Pressing this button with twin engines permits the drives to be trimmed in or out as a synchronized unit.

**Neutral position-** This symbol shows that the engine and drive are not in gear. Note that a safety device keeps the control from starting in gear.

At Zone **C** the following functions are indicated:

**Warning triangle-**This triangle lights up when a system fault is recognized. It will project on the side where the driveline with the problem exists. If an emissions (MIL) light fault appears contact an authorized dealer.

 **CAUTION**

PRACTICE YOUR REMOTE CONTROL  
SHIFTING IN A WATER  
ENVIRONMENT WITHOUT HEAVY  
BOAT TRAFFIC.

 **CAUTION**

TO PREVENT POSSIBLE BODILY INJURY  
AND/OR PROPERTY DAMAGE  
DO NOT ATTEMPT TO ADJUST SHIFT  
OR THROTTLE CONTROLS!  
CONSULT A MARINE PROFESSIONAL.



## Volvo Joystick (Maneuvering Component)



### TYPICAL STERN DRIVE JOYSTICK

The joystick is a component used to maneuver and dock the vessel at low speed. Note that only the docking and high mode functions are used with twin stern drive propulsion. See your manufacturer's engine manual for specific information.

 **CAUTION**

PRACTICE YOUR JOYSTICK DOCKING AND  
MANEUVERING IN A WATER  
ENVIRONMENT WITHOUT HEAVY  
BOAT TRAFFIC.

**High Mode-** This mode may be used to offset sea conditions such as a strong current or high wind. To use make sure the docking button is lighted. Activate high mode by pressing the high mode button on the lower right side of joystick. An audible signal indicates that high mode is activated and the button perimeter lights up.

The high mode function can be deactivated by pressing the button again. An audible signal will sound twice to indicate the high mode is deactivated and the light will go out.

At this point the joystick is in the docking mode.

**Docking Mode-** *Note that when the docking mode is activated, engine speed (rpm) is limited and the vessel steering can only be accomplished through the joystick.*

To activate the docking mode the following pre-conditions must be met:

1. Both engines must be running.
2. Both remote control levers in neutral.
3. Helm station must be activated.
4. Joystick must be in center position.

Press the docking button to activate the docking mode. An audible signal will emit and indicate the docking mode is activated. The docking button light will be visible.

To deactivate the docking mode press the docking mode button. An audible signal will be emitted twice to indicate the docking mode is deactivated. The docking light will go out.

*Note the docking mode will be activated if the remote controls are moved from the neutral position.*

# JOYSTICK FUNCTIONS

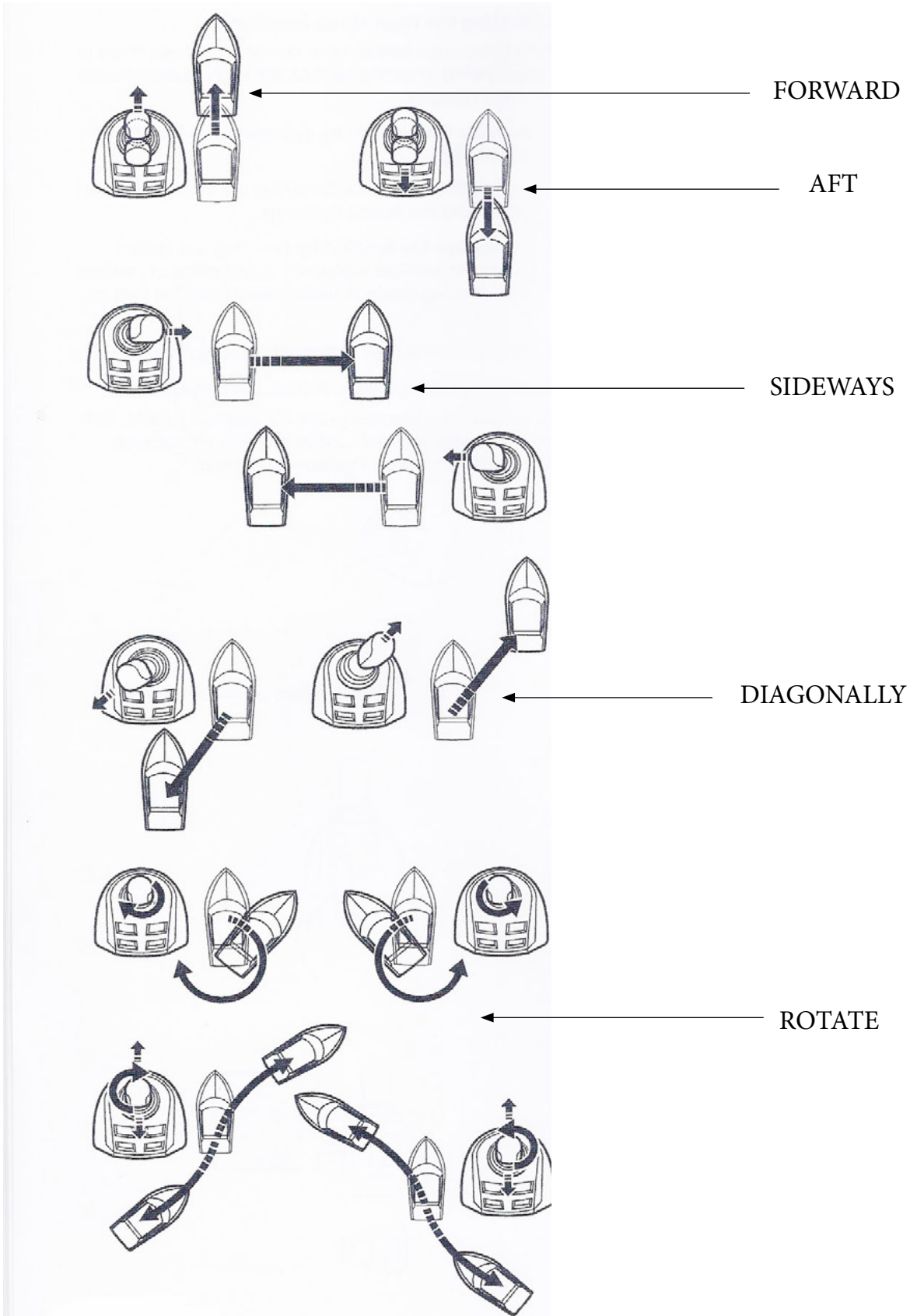

# Engine (Outboard) & Controls

## Introduction



It is important that you read your Yamaha outboard engine operator's manual carefully and become completely familiar with the function as well as necessary maintenance and safety warnings on the engine and propulsion systems. Pay careful attention to the sections on winterization if you live in freezing climates. Extensive damage can result if proper winter storage is not followed in freezing climates. Contact your Regal dealer for information regarding technical issues and parts. Also, refer to the maintenance section of this manual.

 **WARNING**

PREVENT INJURY OR DEATH!  
READ ALL MANUFACTURER'S OUTBOARD  
ENGINE AND PROPULSION OWNER'S  
MANUALS BEFORE OPERATING  
YOUR VESSEL.

This chapter is intended to give general information about the location and function of typical outboard engine and controls. Control systems, engine operation and components can change during a product's production life cycle. Refer to the specific engine owner's manual for your equipment that would include the following information in greater detail.

Engines function is based from four principles; fuel, compression, ignition, and exhaust. The proper ratio of fuel and air must be drawn into the engine's cylinders in order to be compressed by the pistons and ignited by a spark the force of which pushes the piston back down, providing the energy used to turn your propeller, before the engine kicks into the exhaust stage where it expels the by-products. If any of these four functions fail, so does the engine itself.

Beyond these basic concepts of engine functionality there are other factors including engine cooling, lubrication, and electrical systems. The specific details of these systems can be found in the outboard manufacturer's owner's manual for the specific engine option you chose on your Regal boat.

## Engine Removal

In the event an outboard engine needs to be removed from the transom consult your Regal dealer. He has the factory trained knowledge and equipment to remove the engine safely and efficiently.

## Engine Checklist Before Each Outing

Every engine option may require different checks before each use, but a general engine checklist is included here. Refer to your outboard owner's manual for more detailed maintenance information.

- Check engine crankcase and gear case oil levels.
- Check steering fluid.
- Check power trim fluid.

### At Helm/ Deck

- Check power trim for operation.
- Check control lever for operational defects. Check the clip and safety lanyard for functionality.
- Check plotter displays for system readings.
- Check fuel level and ensure the level is sufficient for the trip with a reserve.

## Engine Cooling System

Your typical engine normally utilizes a raw water system for cooling the engine with intakes at the gear case. It is important that this system continues to run unobstructed at all times to avoid hazardous situations and to ensure a safe voyage.

Raw water is drawn up into the outboard vertical drive shaft housing through pick-up feeds in the gear case vicinity.

Water passes through a power head thermostat which controls how much water circulates through the power head. The cool water absorbs heat produced by the engine, before being emitted via the coolant exhaust system.

There is a access hole on the port side of the power head which shows a visual stream of water at all times. If no water is visible with the engine running shut down the engine and investigate the problem. At times this relief hole can be plugged by debris.

### Impeller/ Water Pump

Periodically, the coolant system's impeller and water pump should be inspected for debris, damage or excessive wear due to use, water chemistry such as mineral and/or silt conditions. Damaged parts will affect the system's ability to function, and may cause engine overheating or damage. Contact your closest Regal dealer for more information and outboard manufacturer for maintenance schedules of key outboard engine systems.

### Thermostat

If the temperature gauge starts yielding abnormal readings, it may become necessary to look at or replace the power head thermostat after determining whether it is functioning properly. The thermostat reads the temperature of coolant and determines whether to open or close a valve to allow warm sea water to pass into the exhaust manifold. The thermostat may recirculate hot coolant for the purposes of reaching standard operating temperatures.



If standard operating temperatures have been reached, the thermostat will open a valve and allow hot raw water to exit through the exhaust manifold. For more information read your outboard engine manual or contact the closest Regal dealer. Dealers have the necessary knowledge and tools to troubleshoot any engine related problems.

 <b>WARNING</b>
PREVENT INJURY DUE TO HOT SURFACE! AVOID TOUCHING THE THERMOSTAT OR ITS COMPONENTS WHILE THE ENGINE IS HOT.

 <b>CAUTION</b>
TO PREVENT ENGINE DAMAGE DUE TO OVERHEATING AVOID RUNNING THE ENGINE WITHOUT A FUNCTIONING THERMOSTAT.

### Freshwater Flushing Attachment

Your outboard features a fresh water flushing system. After linking up to a fresh water hose at the flush port, water can be pumped through the engine's raw water cooling system to flush out all salt and debris that may be left behind. Normally there is a hose thread fitting on the side of the engine. After the connection is opened a garden hose is connected to the fitting and the engine can be flushed. It is best to connect the flushing system up when the engine is warm since the thermostat is open at this time to allow water to circulate through the entire head rather than bypassing the cylinder head areas. Do not run engine while using the flushing device as engine damage may occur.

### Engine Electrical System

Your engine utilizes a great deal of electronic equipment. Select equipment sends signals between the engine and the Garmin, while other systems set off alarms, and still others are used by the engine to generate a spark and ignite the fuel. The battery switch controls electrical power distribution to the boat systems.

To regularly maintain your DC electrical system, inspect the battery charge before each trip. Test all gauges and control equipment prior to departure, and replace as necessary. Spark plugs should be replaced according to your engine owner's manual maintenance schedule.

### Gauge Electrical Signals

Your outboard transmits signals through electrical harnesses to different components through the use of NMEA 2000 connections and a "backbone system". A standard Garmin plotter displays the engine functions Also, idiot lights are display tolerances that are classified as being abnormal.

### Alarms

When a malfunction with your outboard engine occurs, the Garmin plotter alerts the skipper of a problem. Common engine problems include overheating, low oil pressure, or a miscommunication with equipment. Learn the alarm systems that apply to your engine by consulting your engine owner's manual.



# CAUTION

AVOID ENGINE DAMAGE OR FAILURE!  
DISCONTINUE ENGINE OPERATION  
AFTER AN ALARM HAS SOUNDED.  
ADDRESS MALFUNCTION BEFORE  
RESTARTING ENGINE.

## Spark Plugs

The spark plug is the piece of equipment that helps make ignition occur. As electrical potential builds on one side of the gap based upon the energy distributed by the distributor, the potential eventually grows large enough to cause the electric current to jump the gap on the spark plug. This spark is what ignites the compressed fuel generating a controlled explosion that will power the piston down and deliver power to the drive shaft.

## Stator

Under normal circumstances, the starter battery would wear down after being used so often to generate a spark for the engine. This isn't an ideal setup because a strong battery is needed for continual operation. A weak battery does no good out on the water. The stator recharges the batteries while the engines are running.

However, in an effort to conserve battery life, each battery switch should still be turned off after every trip and turned on at the start of every trip. This limits the drain on the battery while the boat is not in use. As standard equipment a battery charging system charges batteries while using the dock side cord.

## Fuses

Your engine also comes equipped with fuses that will burn out or “blow” when engine components attempt to draw more power than the piece of equipment or wiring can handle. When the fuse blows, it breaks the circuit, and electricity stops flowing. Before replacing the fuse, investigate the cause of the problem, and why the equipment was overworked. Your outboard engine uses a helm mounted fuse box which is accessible by lifting the starboard bow backrest while others feature in-line fuses, while still others feature a mixture of both. Refer to your outboard engine owner's manual for complete details on your electrical system and the location of any engine mounted over current protection.

## Engine Exhaust System

Your engine expels the by-products of its operation through an exhaust system, just like cars do. In boats however, this exhaust system mixes the debris left over after the power stroke of the engine with the hot water that is expelled after cooling the engine.

Basically the exhaust flows through the power head before expelling the exhaust through the vertical drive housing either just above the propeller, or through the prop shaft.

## Engine Fuel System

Refer to the system chapter of this manual for fuel system specifics. Be sure to read and understand the following warnings.



## WARNING

USE OF ALCOHOL ENHANCED FUEL, OR ANY FUEL OTHER THAN GASOLINE CAN LEAD TO DETERIORATION OF THE FUEL SYSTEM COMPONENTS. THIS CAN RESULT IN FIRE AND POSSIBLE EXPLOSION.



## WARNING

GASOLINE VAPORS CAN EXPLODE!  
BEFORE STARTING ENGINE  
CHECK COMPARTMENTS AND MOTOR WELL  
FOR GASOLINE LEAKS OR VAPORS.



## WARNING

PREVENT INJURY OR DEATH  
DUE TO FIRE OR EXPLOSION!  
RUN GENERATOR BLOWER AT LEAST 4  
MINUTES BEFORE STARTING GENERATOR.

### Engine Lubrication System

Whenever two components rub together, friction causes wear on both components. To minimize the wear on your engine, a lubrication system has been put in place to help components slide next to each other easier. This is particularly important within the inner workings of an engine. It is important to ensure your lubrication system is working properly at all times.

Your Regal utilizes lubrication and fluids that need regular check ups. Refer to your outboard engine owner's manual for specific details regarding the proper maintenance of the lubrication system.

*Note that your outboard uses other lubricants in addition to engine oil such as power trim fluid and prop shaft gear case lubricants to reduce wear on moving components. These fluids should be checked according to the recommended maintenance procedures determined by the outboard manufacturer.*

### Engine Oil

The purpose of engine oil is to lubricate the internal components of the engine and ensure parts that regularly move against each other have reduced friction to lessen wear and noise between components. An oil filter keeps metal particles and water out of the engine's interior.

Yamaha engines performing on regular oil should have the oil drained and replaced after the first 20 hours of operation or 3 months, and every 100 hours or at 1 year intervals thereafter. Ensure the correct oil is used by referring to Yamaha outboard engine manual

### Gear case Oil

Gear case oil keeps all the mechanical components of the prop shaft gear assembly functioning optimally. It reduces friction in the gear case as the gears revolve. Sometimes gear case oil is called gear lubricant. Gear case oil should be inspected periodically according to factory maintenance schedules. Use the outboard manufacturer's recommended oil.

### Power Trim Fluid

Power trim fluid allows your outboard to trim up or down. This is particularly useful when trying to get your boat to plane.

Power trim fluid is used in hydraulic rams that maneuver the outboard unit. Power trim fluid should be checked regularly in the reservoir which is located in the bilge.

## Propeller System

Regal has carefully tested and chosen the propellers to give your outboard boat the best possible performance based on the engines and propulsion package you choose. We have allowed for the additional weight in equipment that might be added to the boat. It is recommended to carry a spare set of propellers and hand tools onboard in order to handle emergency propeller changes.

Each Yamaha propeller displays the following information:

1. Propeller pitch shown by inches.
2. Propeller type (L for left or R for right).
3. Propeller diameter in inches.

Your Regal features twin outboards. The port engine rotates counterclockwise and uses a left hand propeller. The starboard engine rotates clockwise (standard) and use a right hand propeller. Read and understand the label below.

 **WARNING**

AVOID A POSSIBLE ACCIDENT!  
NEVER USE A STANDARD PROPELLER  
ON A COUNTER ROTATION ENGINE, OR A  
COUNTER ROTATION PROPELLER ON A  
STANDARD ENGINE. THE VESSEL COULD  
GO IN THE OPPOSITE DIRECTION EXPECTED  
FOR EXAMPLE;  
(REVERSE INSTEAD OF FORWARD)

TYPICAL PROPELLERS SHOWN

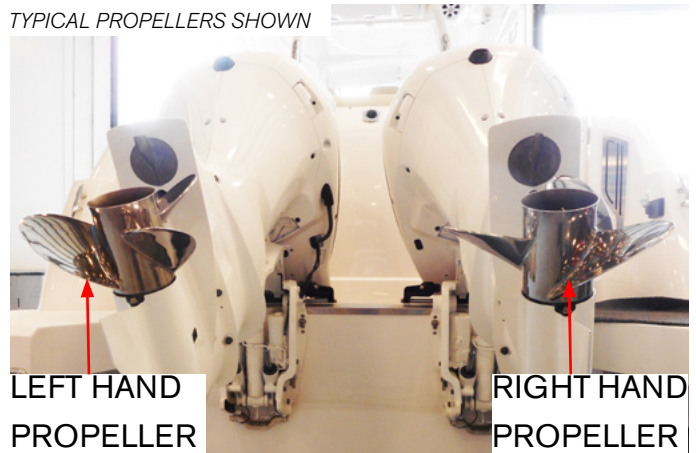

Refer to the outboard manual for procedures, as the application is unique to the manufacturer. Call a marine professional or your Regal dealer to order a spare propeller set.

## Propeller Checklist

At least twice a year, check the propeller for:

- Loose, missing, or corroded hardware.
- Nicks, dings, or missing propeller material
- Bent propeller blades.
- Objects wrapped around the prop (fish line)
- Decomposing propeller blades (electrolysis symptom).
- If equipped, check the propeller rubber hub for slippage

Contact a propeller shop or your closest Regal dealer if any of the above symptoms exist. They have purchased special equipment to refurbish polished stainless steel propellers.



## Checking Engine Mounted Fuel Filter (Typical)

As part of select outboards under the motor shroud (engine cover) on the lower port side of the outboard engine is a fuel filter. Periodically check to ensure the fuel filter/element is clean and free of water. Check for leaks after starting the engine.

Note the fuel filter bracket must be loosened in order for the fuel filter to be removed. It is recommended to carry extra fuel filter elements on board in a clean, dry container.

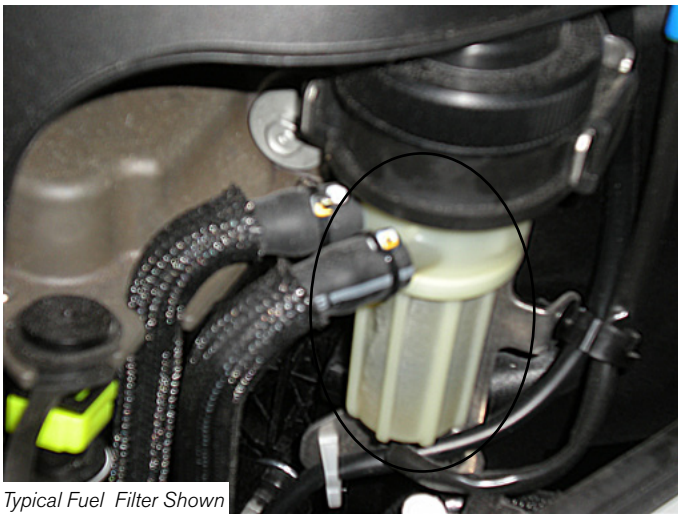

Typical Fuel Filter Shown

For detailed information on filter maintenance refer to the outboard manufacturer's owners manual or contact a Regal dealer or marine professional.

## Checking 10 Micron Water Separator Filter



Periodically before embarking on a cruise check the fuel filters. A 10 micron in-line water separator filter for each engine is installed in the aft bilge. Use an oil spanner type wrench and turn the filter

counterclockwise to remove the element. With a clean pan empty the filter contents into it. Water in fuel tends to hug the bottom and will show a different color than the fuel. Also, when you tilt the container you will see any water droplets travel along the container bottom.

At least yearly or on an as needed basis replace the filter element. Fill the element up with fresh unleaded fuel of the correct octane rating and turn it clockwise until tight. Finish tightening with the spanner wrench. As always check visually for leaks and preform a sniff test to detect any fumes before starting the engines.

If your outboard propelled vessel is outfitted with a generator run the bilge blower system for at least 4 minutes.

It is a great idea to keep extra filter elements on board in protective wrap for emergency use. These filters are available on-line, through marinas, retail marine outlets, or can be ordered via your closest Regal outboard dealer.

## Checking Engine Crankcase Oil

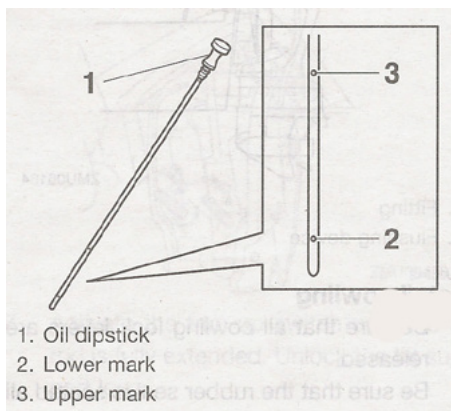

Your Yamaha outboard features 4 cycle engine operation. Unlike 2 cycle outboards which mix gas with oil

technology, the 4 cycle engine uses crankcase 4 cycle oil to lubricate internal moving parts. This operation is similar to automobile engine technology. As part of this process, there is a dipstick placed in the crankcase to offer periodic checking of engine crankcase oil.

To check the crankcase oil do the following:

1. Ensure the outboard is setting in a flat vertical position or the dipstick may not display an accurate oil level.
2. Remove the crankcase oil dipstick and wipe it clean.
3. Reinstall the crankcase oil dipstick completely into the hole. Remove it again.
4. The oil level should be between the upper and lower dipstick holes. .As needed add the manufacturer's recommended oil or contact your closest dealer especially if the oil is contaminated with water which will show a milky color verses a clear look. Refer to the outboard manufacturer's owners manual for oil changing maintenance schedules.

## Checking/Filling Crankcase Oil- (Cont.)

When adding crankcase oil be sure to utilize the manufacturer's recommended type and viscosity. For changing crankcase oil contact your closest Regal dealer for additional information since they have the special tools and knowledge for these maintenance procedures.

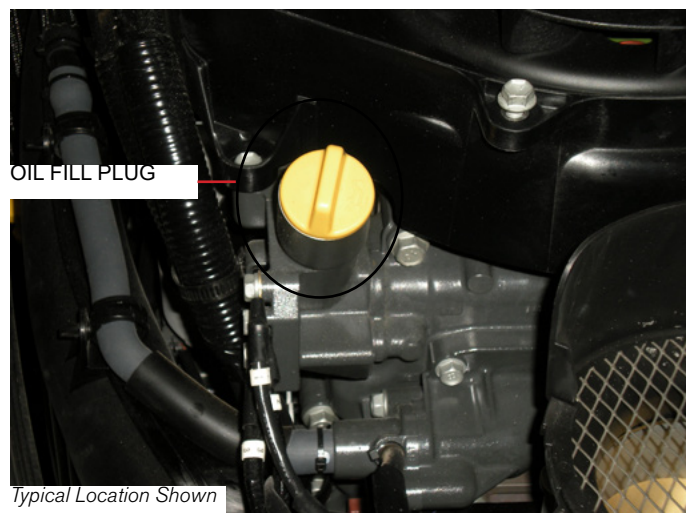

## Flushing Device

Your Yamaha outboard features a flushing device which when connected to a garden hose circulates fresh water through the engine to purge unwanted debris such as found in salty, brackish, and silty water.

To use open the flushing device by turning it counterclockwise. Notice there is a garden hose bib thread. Attach the male end of a garden hose to the fitting and tighten it. Make sure the fitting does not leak as the power head could overheat and cause internal damage. It is best to perform this flushing procedure with the engine still warm from a cruise as the thermostat will be open and will permit more efficient water circulation thru the powerhead and water jacket components. Turn on the fresh water supply. When flushing completed remove the garden hose from the fitting and reattach the hose connections and of course check for tightness.

*Note not to start engine during this procedure as overheating and engine damage may occur.*

*Note that the location of your flushing device is model dependent and may differ from photo. Refer to your Yamaha operator's manual for further information.*



*Typical Flushing Device Shown*



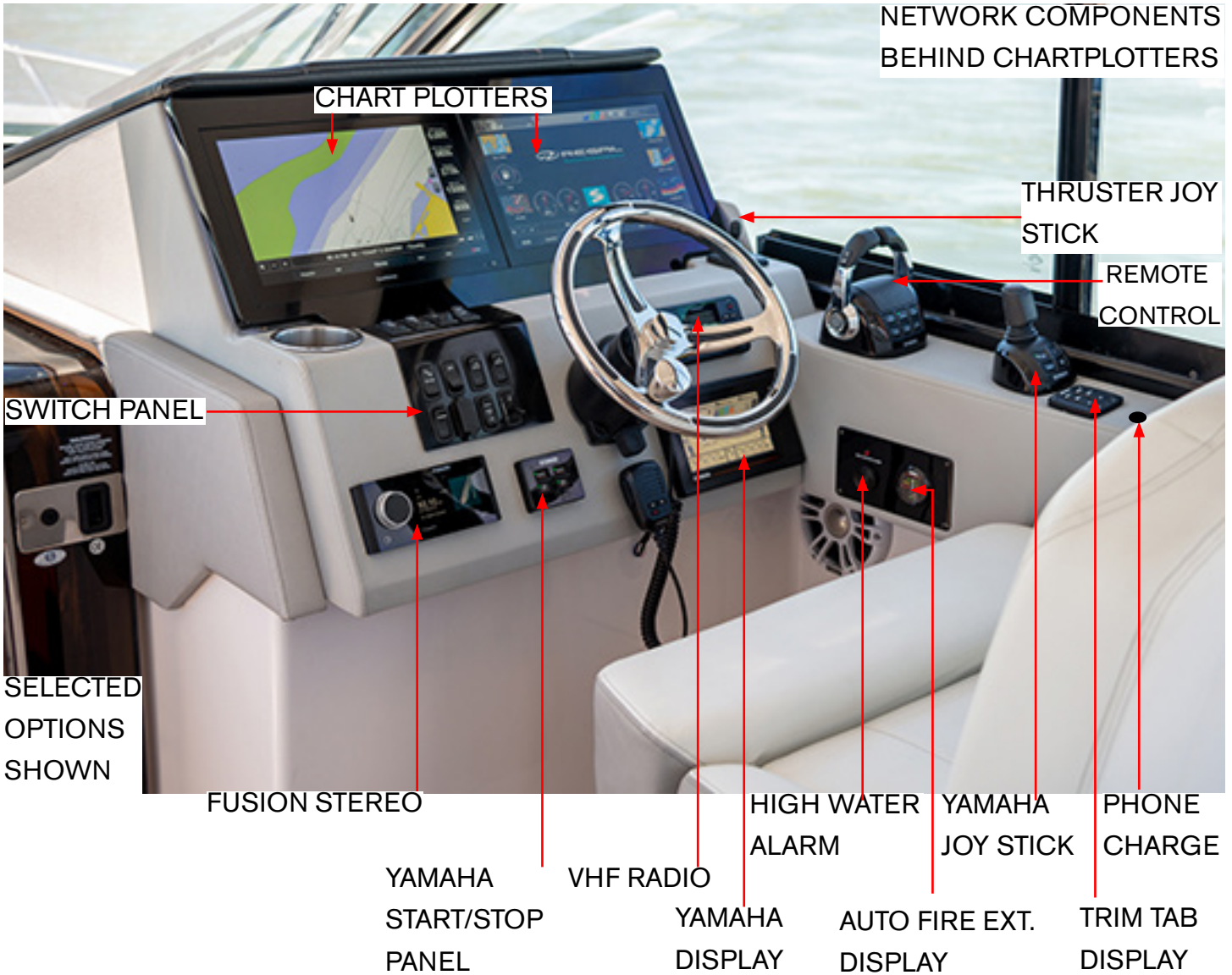

Helm Overview

The helm station is equipped with the ability to monitor engine functions through a Garmin chart plotter. Close observation of the digital display is recommended throughout the trip as you can split the screen to accommodate GPS functions along with monitoring basic engine systems including fuel usage and hours for maintenance cycles. This works in addition to the outboard engine manufacturer’s alarm system.

The Garmin chartplotter system is available as a single or dual screen component.

*Note that with the battery switches at the battery activation panel in the “off” position, there is no power to the helm and the ignition switch will not function.*

Select components are protected by the main DC distribution panel located in the cabin. Refer to the systems chapter for additional information.

*Note that the trim tab display panel is just below the Yamaha joystick as it is not shown in photo above.*

*Note that select items above may be optional components and may not be installed on your vessel.*



## Garmin Engine Monitoring Display



Typical Display Shown

A Garmin single or dual chartplotter is standard equipment on your outboard vessel. The unit displays many GPS features along with the ability to monitor engine system functions including tachometer; engine revolutions per minute (rpm's), GPS speed, voltage, fuel flow rate, trim, and temperature along with tracking engine hours.

Note that there is a certain amount of redundancy as the Garmin display along with the Yamaha CL7 display may overlap information.

Fusion uses its own display screen on the chartplotter for audio controls on the vessel.

Note that the Garmin and Fusion circuitry use individual DC sources to power up the system. The key switch does not power up these 2 systems.

1. To power up the Garmin plotter ensure the house main battery button is pressed on the battery activation panel. Then press the on button located at the upper chartplotter display.

2. The function AV/Gauges,Controls will appear as one of the choice boxes. Press the box. Another screen with engine will appear.

3. Press the engine box and the engine gauge displays will appear (oil pressure is engine code driven only).

4. The Garmin plotter provides setting up very personalized displays such as the Favorites one shown below. Refer to the Garmin owner's manual for further information.



## Helm Components-Typical (Behind Chartplotters)

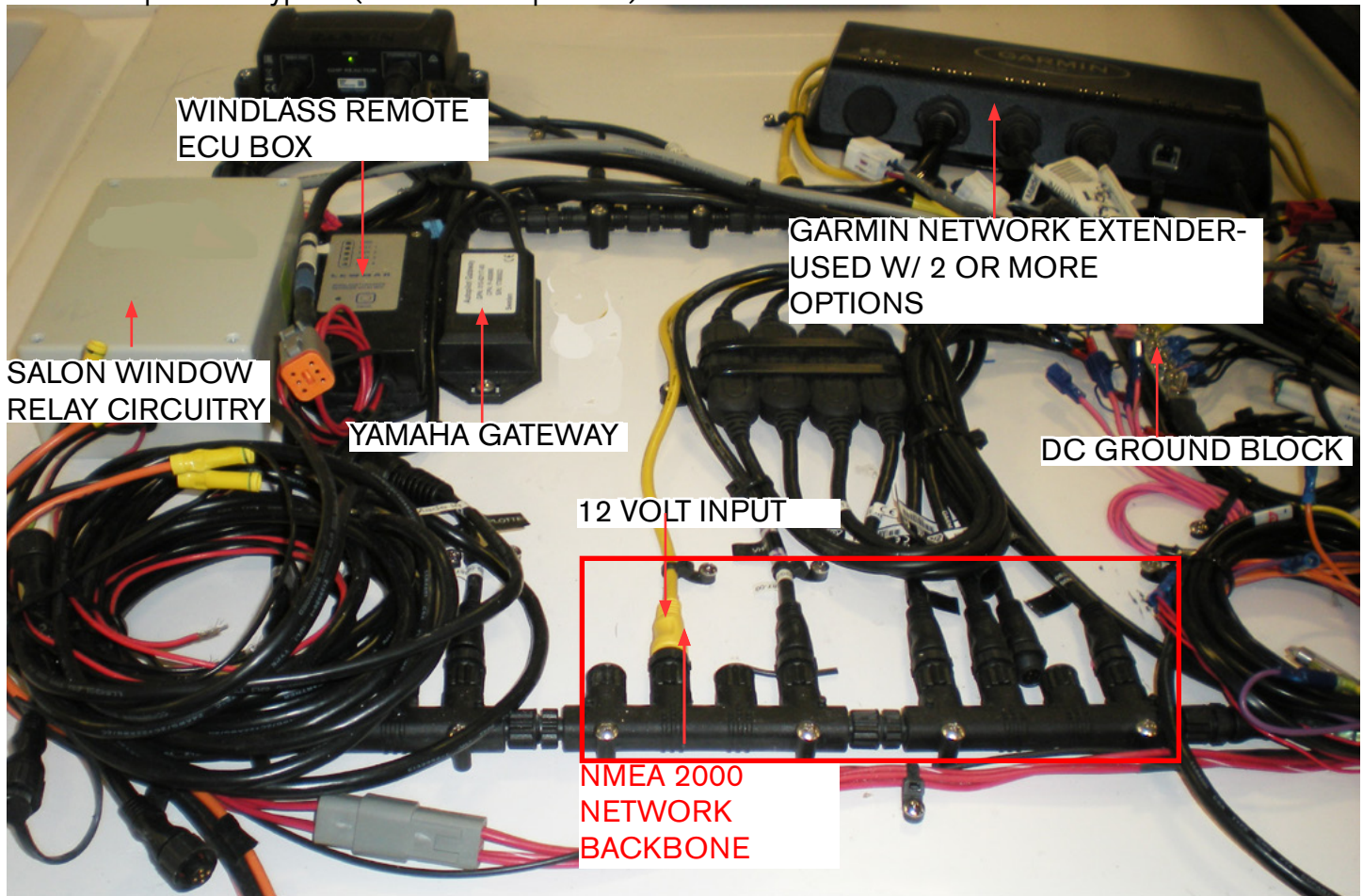

There are several major systems and related components housed behind the helm. To access for service first unplug the shore power cord from the vessel inlet plug. Then turn off all battery switches at the battery activation panel. Remove the screws holding the Garmin plotters and all components are now accessible. Shown above is the outboard version.

*ECU= Electronic Control Unit*

*Note drawings are available in the technical section of this manual which further define the wiring circuits and components.*

## Helm Switch Panel



### Helm Seat

This switch controls the forward and backward helm seat movement.

### Sun Roof

This switch controls the hard top sun roof forward and aft movement. It is a good idea to close the sun roof when leaving the vessel for extended periods and during rough sea conditions.

### Windlass

This switch supplies current to the windlass up and down switch mounted at the anchor rope locker. Also, it activates the windlass remote control.

### Horn

This momentary switch controls the electric horn at the hardtop. Make sure the horn is tested before each outing. There may be an adjustment screw on the horn top to alter the horn tone.

## Nav/Anc

This on/off/on switch energizes the center bow red/green navigation light and stern light as a standard configuration as the top portion of the switch is pressed. When the bottom portion of the switch is activated the anchor light all-around portion illuminates on the hard top. Check navigation lights before each outing to ensure the bulbs are working properly and the wiring circuitry is delivering current to the light fixture.

## Acc

This switch controls any after market component that may be added to the vessel. Always ensure that the amperage draw of the component is safely within the amperage limits of the switch circuit.

## Fwd. Bilge

This switch covers the forward bilge pump. This pump is located below the cabin steps under the floor hatch. It is close to the shower box. Periodically check the pump float mechanism to ensure it is activating properly and the pump grate for debris.

## Aft Bilge

This switch controls the aft bilge pump which is located below the Lazarette compartment storage hatch in the aft bilge. Periodically check the float mechanism to ensure it is activating properly and the pump grate for debris.



## Blower

This switch controls the DC powered ventilation blower at the starboard hull side of the bilge. The powered ventilation system is used on outboards when an optional generator is installed. It removes any fuel vapors via hoses installed in the lower third of the bilge. Always run the blower for at least 4 minutes before starting the generator. Keep the blower on during generator usage.

***Note to read and understand the blower warning label on the lower right side of the switch panel.***

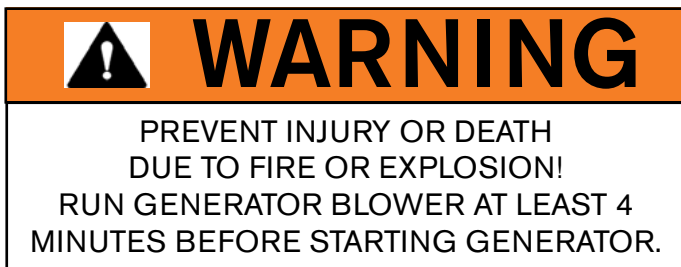

## USB Charging Port

This charging port features dual USB ports (4.8 amps) and a water resistant dust cover. This component features intelligent device recognition for rapid charging of phones, tablets, and other mobile devices. When not in use snap the protective cover in place to protect the ports from moisture and corrosion.

## Panel LT

This switch controls the helm station lighting. When you depress and hold the BRIGHT segment of the switch the helm lighting will ramp up the brightness. When desired light level is reached release the switch. Depress the lower DIM segment and hold to dim the helm lighting to a desired level.

## Windshield Wiper

This switch controls the windshield wiper and wash systems. Note the switch is “off” when the handle is in the down position.

As the handle is moved up a series of wiper speed positions are available. The highest speed position is found at the top of the switch.

To operate the wash system simply press on the wash icon on the switch while operating the wiper and water will eject from the wiper frame on to the glass.

Note not to run the windshield wiper over a dry windshield as debris could cause scratching of the tempered windshield glass.

*Note that select switches may represent optional equipment not installed on your vessel.*



# Engine Starting/Stopping Controls

## Overview



The following general information covers basic starting and stopping of your outboard engine(s). Read and understand all information on remote controls, fueling and operational procedures. Pay particular attention to all labels. Refer to the outboard engine owner's manual for further in depth propulsion system starting information.

## Start-Up/ Stop Operation

### ELECTRONIC KEY SWITCH



INDICATOR LIGHT

See the photo above showing the working parts of the electronic key switch/ ignition panel.

Make sure each engine battery switch button is pressed at the **battery activation panel**. Pressing the switches at the activation panel supplies current to the Yamaha electronic key switch/ignition panel. Start engine only in a well ventilated location to avoid CO buildup.

The electronic key switch ignition system utilizes a key fob to unlock and lock the Y-cop anti theft system.

To unlock the security system you must swipe the wireless key fob close to the top of the ignition panel. You will hear 2 short bipes. The indicator light will flash. Press the ignition button for each engine and then press start/stop button once and release for each engine.

To lock the security system when leaving the vessel swipe the key fob close to the top of the ignition panel. You will hear 1 short bipe and the indicator light will flash indicating the ignition and fuel injection system have been disabled.

Note when activated there is a green light bar in the corner of each switch function.

After engines start monitor the Garmin engine and Yamaha display panels for alerts. Also, ensure there is water spraying from the engine coolant water pilot hole on the side or the aft end of the lower cowling. *Note that location of water pilot hole may vary by outboard model. See photo on the next page.*

To stop each engine after starting press the start/stop button. Repeat with other engine.

Make sure the control is in the neutral idle position before attempting to shut down the engine(s). Always let the engines idle for a few minutes after a hard run.

Press and hold the start/stop button for each engine.

Note after starting no water is emitting from the pilot hole stop the engine and identify and rectify the problem. For more information refer to the Yamaha owner's manual or contact your nearest authorized Regal or Yamaha dealer.



WATER PILOT HOLE 425 YAMAHA SHOWN

**! WARNING**

PREVENT INJURY OR DEATH!  
KEEP PASSENGERS SEATED WHILE  
UNDERWAY AND CHILDREN AWAY  
FROM HELM CONTROLS.

**! WARNING**

AVOID INJURY OR DEATH RESULTING FROM  
LOSS OF CONTROL!  
NEVER LEAVE THE HELM  
WHEN THE ENGINES ARE RUNNING!  
KEEP EVERYONE SEATED WITH LIFE VESTS  
ON WHILE VESSEL IS UNDERWAY!

**! CAUTION**

AVOID ENGINE DAMAGE OR FAILURE!  
CHECK THE ENGINE CRANKCASE  
OIL LEVEL  
BEFORE STARTING ENGINE(S). IF LOW ADD  
APPROPRIATE OIL TYPE AND QUANTITY.

## Remote Control

Dual outboard vessels use a twin binnacle control for shifting and throttle operations. The remote control handles control forward, neutral, and reverse outboard shifting operations for both engines. The control handles can be used independently for maneuvering in tight quarters. The control features power trim up and down functions. See the following information for component description and features. Read and understand the outboard motor manufacturer's manual before attempting to operate the vessel remote control.

Practice docking operations using the remote control in a controlled environment to learn the basic control functions.

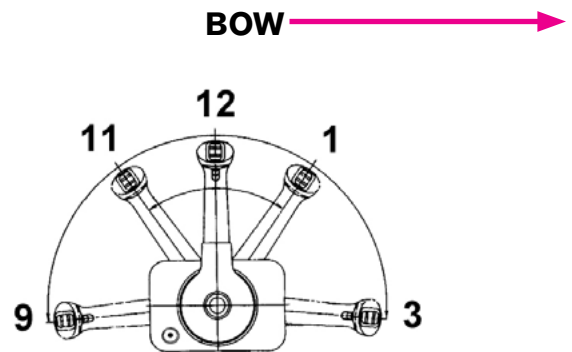

Profile Of Typical dual Engine Control Lever Showing Five Positions



Shown in the neutral position with idle throttle control. This is the detent position for starting and stopping the engine(s). Pushing the detent button in and pushing the throttle handle forward will afford increased neutral rpm throttle advancement.



Pushing the throttle control lever forward from the neutral 12 o'clock position to the 1 o'clock position will engage forward gear with minimal throttle. From

the 1 o'clock position to the 3 o'clock position, the vessel is in forward gear with differing levels of throttle selections.



Pulling the throttle control lever back from the neutral 12 o'clock position to the 11 o'clock position will engage the reverse gear with minimal throttle. From

the 11 o'clock position to the 9 o'clock position, the vessel is in reverse gear with differing levels of throttle selections.

As you shift from neutral to forward or reverse, push the neutral release button, this allows the control lever to come out of the indented position.

The control lever features a *neutral safety switch* which ensures the outboard engine and control are in the indented neutral position for starting the engine. You will hear a distinct sound and see a blinking light and will feel the remote control's rotation lock in the detent position.

*Note that if you turn the key and press the start/stop button and the engine starter doesn't crank the engine, ensure the control lever is in the neutral position.*

Your control lever also features a trim control switch. This switch allows the captain to set the trim for the outboard drives from the helm either up or down to achieve a desired outboard running position.

Follow these points when shifting:

- DO NOT shift quickly from forward to reverse gear positions. Drive system damage may occur.
- DO NOT "pump" the throttle in neutral as it is normally not needed since today's engines use an enrichment valve system that requires very little starting throttle.
- DO NOT try to shift into forward or reverse gear at high rpm's. Personal injury, drive system, or property damage may result.
- Only use idle throttle positions when docking or maneuvering in tight quarters.
- Wear your safety lanyard at all times.
- Never shift the controls with the engine not running. Control, linkage, and/or outboard drive gear damage may occur.
- For more information, read your outboard engine manufacturer's manual before operating the remote control.



# Yamaha Remote Control Operation w/Twin Outboards

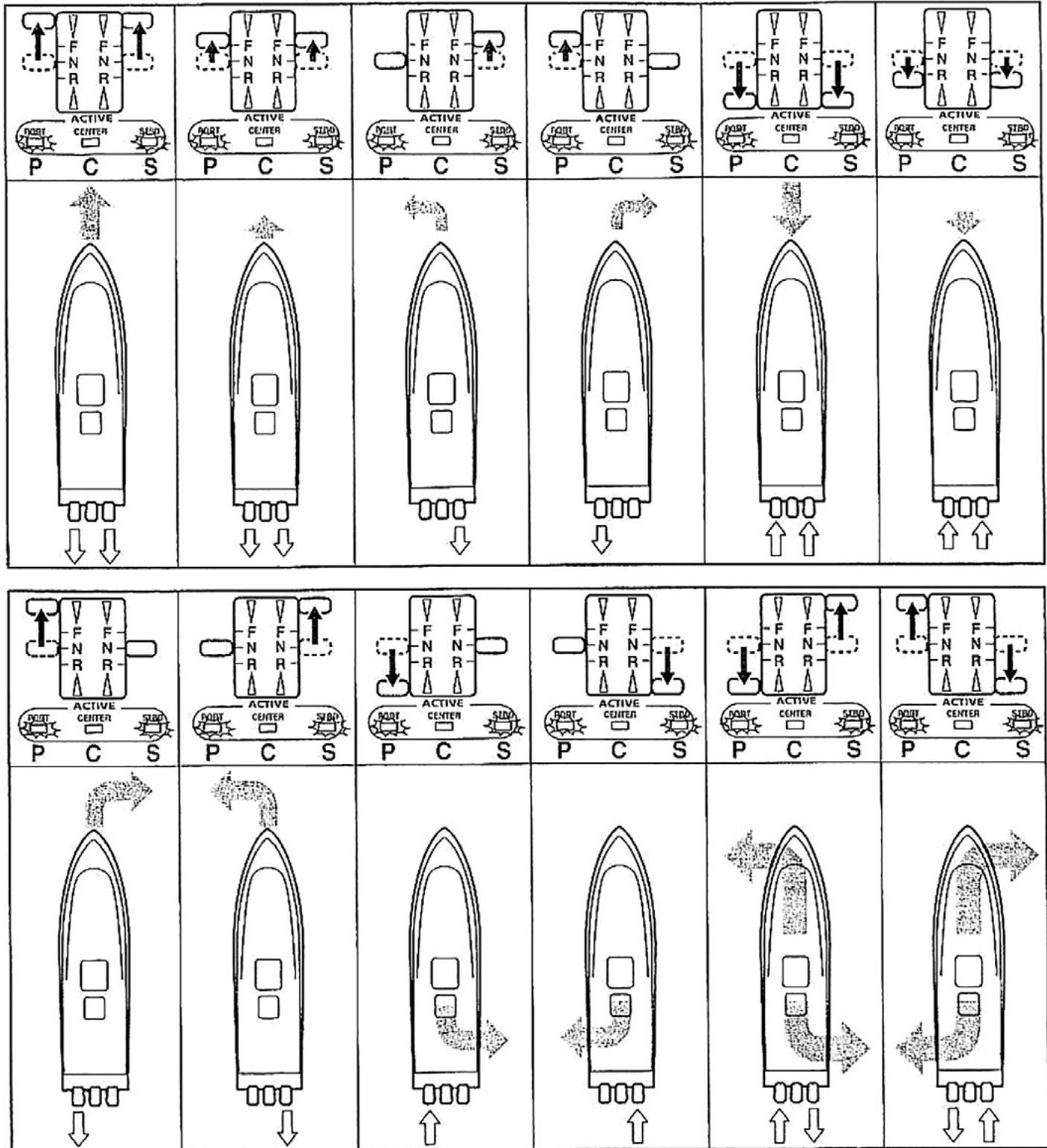

Courtesy of Yamaha

## Safety Lanyard (Interrupter Switch)

The safety lanyard (found on the ignition panel) sometimes called an interrupter switch is attached to the operator and the ignition panel. Should the operator lose control of the vessel and become dislodged from his/her seat or fall overboard, the lanyard will shut the engine off. Make sure the lanyard is installed to a part of clothing such as a belt before operating the vessel.



**SAFETY LANYARD  
ATTACH HERE**

Ensure the lanyard is secured to the ignition panel post or the engine will crank but not start. Keep passengers seated and away from controls.

*Periodically test the safety lanyard once the engine is started at the dock by simply pulling the lanyard from its latching mechanism and the engine will stop indicating the safety lanyard circuit is working properly.*



## **WARNING**

LANYARD MUST BE ATTACHED TO THE OPERATOR WHILE THE ENGINE IS RUNNING. A QUALIFIED OPERATOR MUST BE IN CONTROL AT ALL TIMES. READ AND UNDERSTAND THE OWNER'S MANUAL BEFORE OPERATING VESSEL.



## **WARNING**

IF THE LANYARD IS IN THE "OFF" POSITION THE ENGINE WILL CRANK OVER BUT WILL NOT START. ENSURE SAFETY LANYARD IS ATTACHED CORRECTLY AND SWITCHED TO THE RUN POSITION ON THE IGNITION PANEL.

## Joystick

As part of the Yamaha outboard Helm Master control system a joystick is installed on your vessel. The joystick permits the vessel to maneuver in tight mooring situations even made more opportunistic with wind and water conditions such as current. The joystick permits the boat to move 360 degrees and features a boost feature.

Joystick controls both port and starboard engines.

To activate the Helm Master joystick engage both port and starboard remote control handles in a neutral position.

Press the joystick button on the joystick and that segment will light green. This also engages both engines to joystick mode for docking. Note when pressed the high mode button permits a higher rpm range window for high wind and current situations.

The basic joystick movements are the following:

1. Pushing the handle forward causes the vessel to make headway.
2. Pulling the handle backward causes the vessel to move backward.
3. Moving the handle 90 degrees sideways causes the vessel to move in a port or starboard direction.
4. Twisting the top of the joystick to the right causes the vessel to move to starboard.
5. Twisting the top of the joystick to the left causes the vessel to move to port.

See the basic joystick function information on the next page for a “cause and effect” view of joystick operations.



For further information regarding the engine joystick operation refer to the engine operator's manual or Helm Master manual located in the owner's information packet or visit the Yamaha web-site.

# BASIC JOYSTICK FUNCTIONS

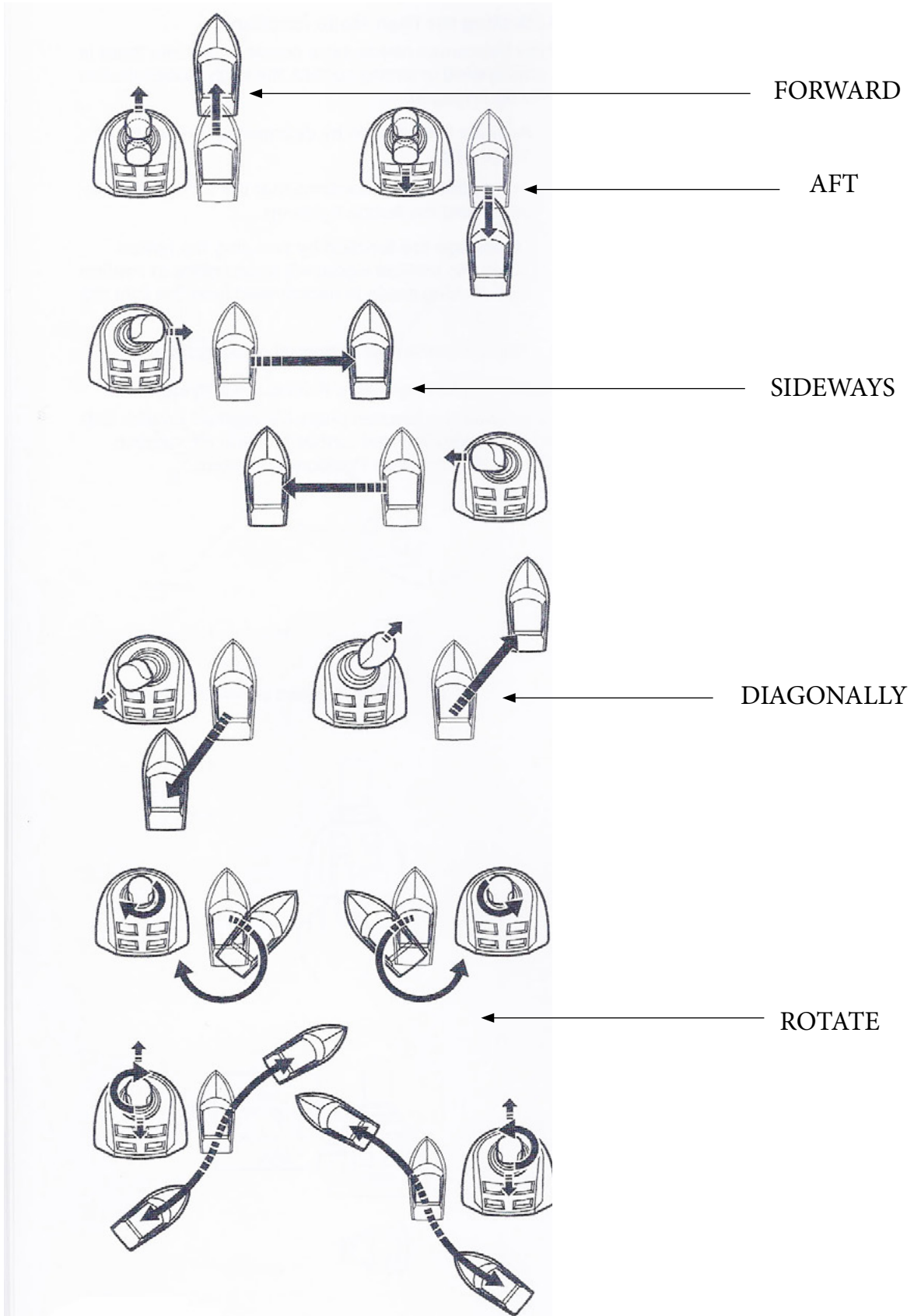



## Helm Master Steering System w/Twin 5.6L (425 hp) Yamaha Outboard Propulsion

### System Overview

**The Yamaha 5.6L (425 hp) propulsion system** utilizes a fully integrated control system called Helm Master. Components can include an automated boat positioning system, digital remote control, joystick control, CL7 display panel, digital steering helm, powertrain control unit, steering control unit along with the electronic key switch. The Helm Master uses electronic components integrated into the engine itself. This electronic is sometimes referred to as a “fly by wire” system.

We will briefly describe each system component. Reference your 5.6L Yamaha operators manual for more detailed system information.

### Component Description

**Digital Remote Control-** This control is designed to integrate with the electronic helm and joystick.

A green LED is lighted when any of the following buttons are selected:

**Speed Control-** sets RPM through a full operating range of the outboard.

**Single Lever-** permits port lever to control shifting and speed of both outboards.

**Trim Assist-** synchronizes the trim angle to a certain RPM so both outboards will automatically trim to the desired trim angle.

**Free Throttle-** permits unit selected to be throttled up with the shift function disengaged as programmed through the CL7 display.

**Joystick Control-** integrates the shift, throttle, and steering controls. The joystick permits the vessel to move fore, aft, port, starboard or diagonally. The joystick control features the ability to rotate for positioning and turning the vessel. There is a high mode for increased engine RPM which assists in tight maneuvering or extreme weather conditions.

**Electronic Key Switch-** This system powers the ignition panel with the use radio frequency activated key fob. Pass the key fob close to the ignition panel and the panel is energized for starting engines.

**CL7 Display-** This system displays a variety of Helm Master functions and features expandable sophisticated operation modes. The display includes operator settings such as trim assist, steering friction, off timer, and joystick calibration.

*Note that there are display settings that can only be changed by an authorized tech. These settings include auto configuration, air purge, steer sensor, lever sensor, toe in/out adjust, joy thrust, lock to lock, and steering friction set.*

**Second Station-** This feature is not used on the 36 Grand Coupe or Outboard.

**Digital Steering Helm-** This helm incorporates an adjustable tilt feature for operator comfort. The unit is controlled electronically by two harnesses that split into four connections; two for the joystick and two for the remote control unit.

**Powertrain Control Unit-** This unit receives signals from the electronic helm unit to operate the electric pump system. There is one PCU per outboard engine.

**Steering Control Unit-** This unit receives signals from the steering cylinder position sensor and the PCU to permit steering and joystick control operation.

**Steering Cylinder-** This component features sensors that control engine positioning.

**Power Steering Pump-** This unit used on select units incorporates hydraulic pressure to the steering system.

**Bypass Valve-** The purpose of this valve on select units is to permit the hydraulic system at the hydraulic pump to be by-passed for emergency return to a safe haven capability or for service measures.

# 36 XO TWIN 5.6L (425 hp) YAMAHA OUTBOARD HELM MASTER STEERING SYSTEM SCHEMATIC

7/23/2020

VK Battery Management System Electronic Steering EL-131.jpg

Subject Work Instruction: VK Battery Management System Electronic Steering	Issue Date: 08/25/2020	Rev: 1	Document No. EL-131
Approved By: Mark Journey	Written By: Kyle Quisman	Rev Date: 07/23/2020	Page: 1 of 1

Battery Management System  
Through-hole Stud

[ REFERENCE ONLY ]

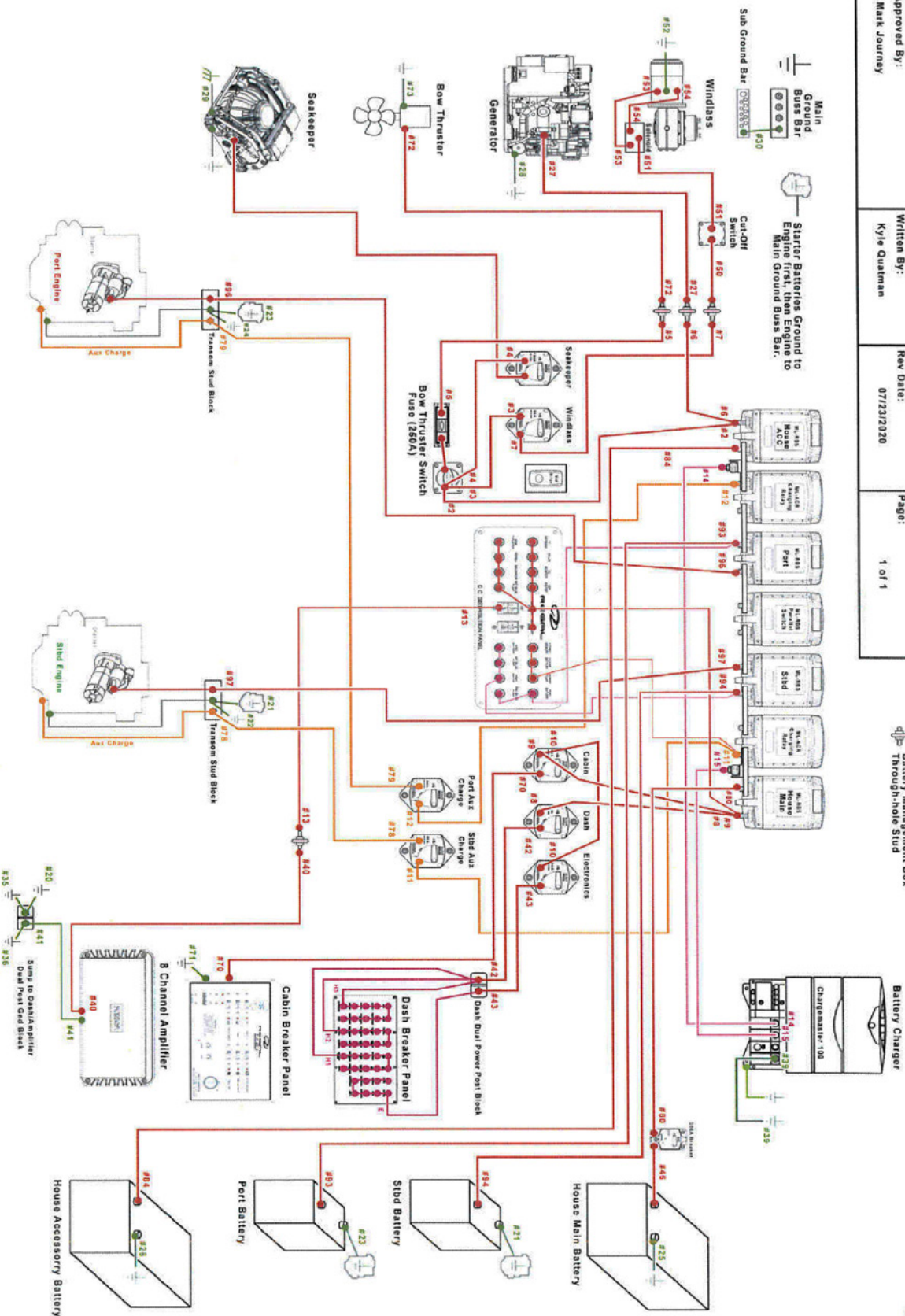

## Hydraulic Power Steering System w/Twin 5.3L (350 hp) Yamaha Outboard Propulsion

### System Overview

Your vessel may feature twin 5.3 Yamaha 350 hp outboard engines as standard equipment with a Yamaha hydraulic steering system.

*Note that the general helm components of the hydraulic steering system are similar to the 5.6 Yamaha outboard system but the power steering operation uses hydraulic pumps and other related components which differ. Refer to the following pages that include a 5.3 wiring schematic w/ components and a description of the hybrid system parts and operation of the the system.*

We will briefly describe the hybrid system and their system function. Overall this system lends itself to twin outboard installations well with an effortless “power steering” feel. In addition, this system features light friction at low speed and higher friction at higher speed to provide a higher degree of maneuverability. Furthermore, it can be programmed for toe-in and toe-out settings which provide optimum vessel performance.

The hardware at both the helm and engine must be checked regularly for tightness, lubrication, and leaks. Check the steering system for full steering to port and starboard before disembarking.

The main system components are the electronic helm, steering control unit, hydraulic steering pump and “smart cylinder”. Note the adjacent drawing which shows normal system components. For service contact your closest authorized Regal dealer.



# 36 XO TWIN 5.3L (350 hp) YAMAHA OUTBOARD HYDRAULIC STEERING SYSTEM WIRING SCHEMATIC

7/23/2020

VK Battery Management System Hydraulic Steering EL-127.jpg

Subject Work Instruction:	Issue Date:	Rev:	Document No.
VK Battery Management System Hydraulic Steering	08/25/2020	1	EL-127
Approved By:	Written By:	Rev Date:	Page:
Mark Journey	Kyle Quatman	07/23/2020	1 of 1

Battery Management Box Through-hole Stud

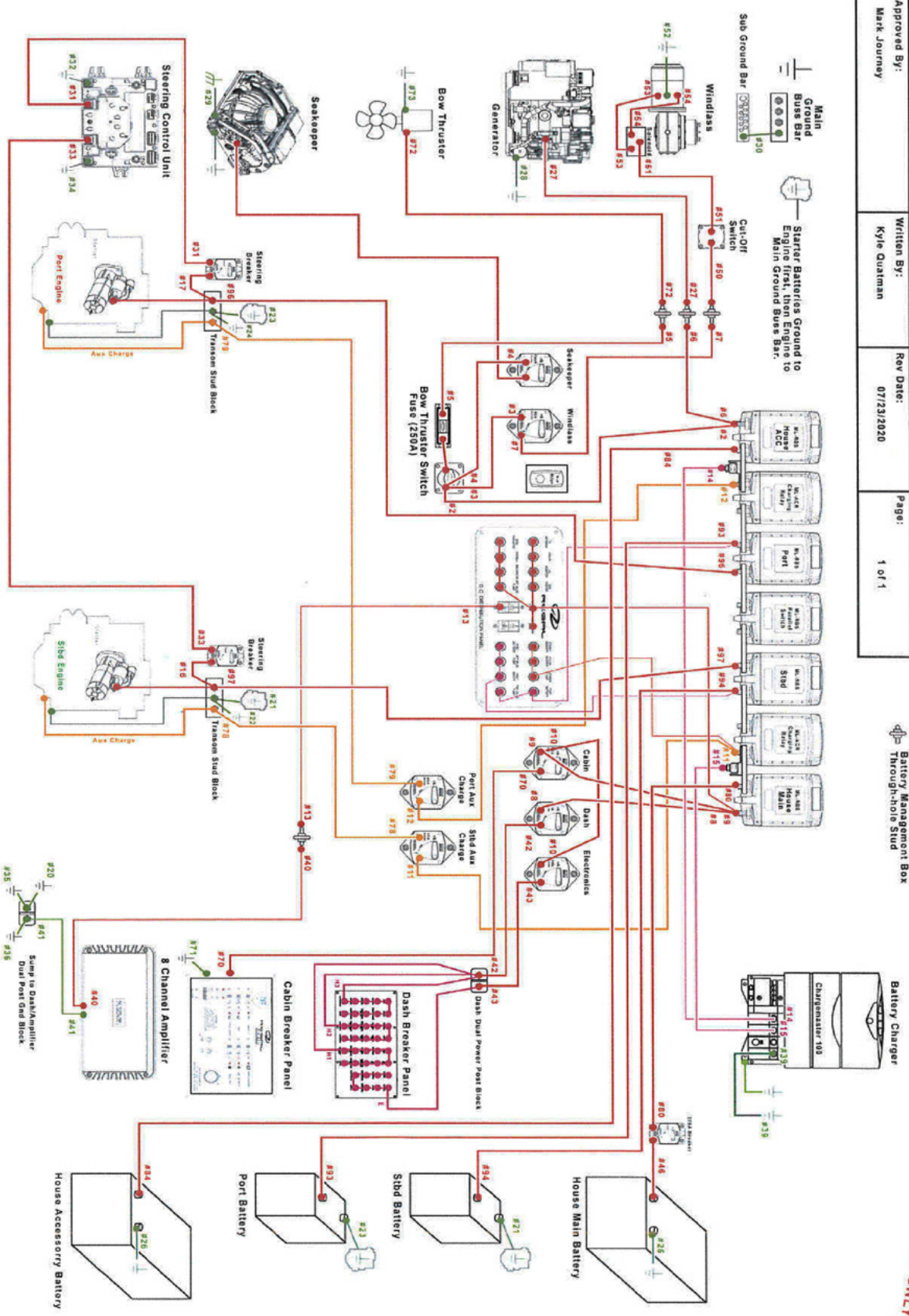

[ REFERENCE ONLY ]

# Yamaha Hydraulic Steering System

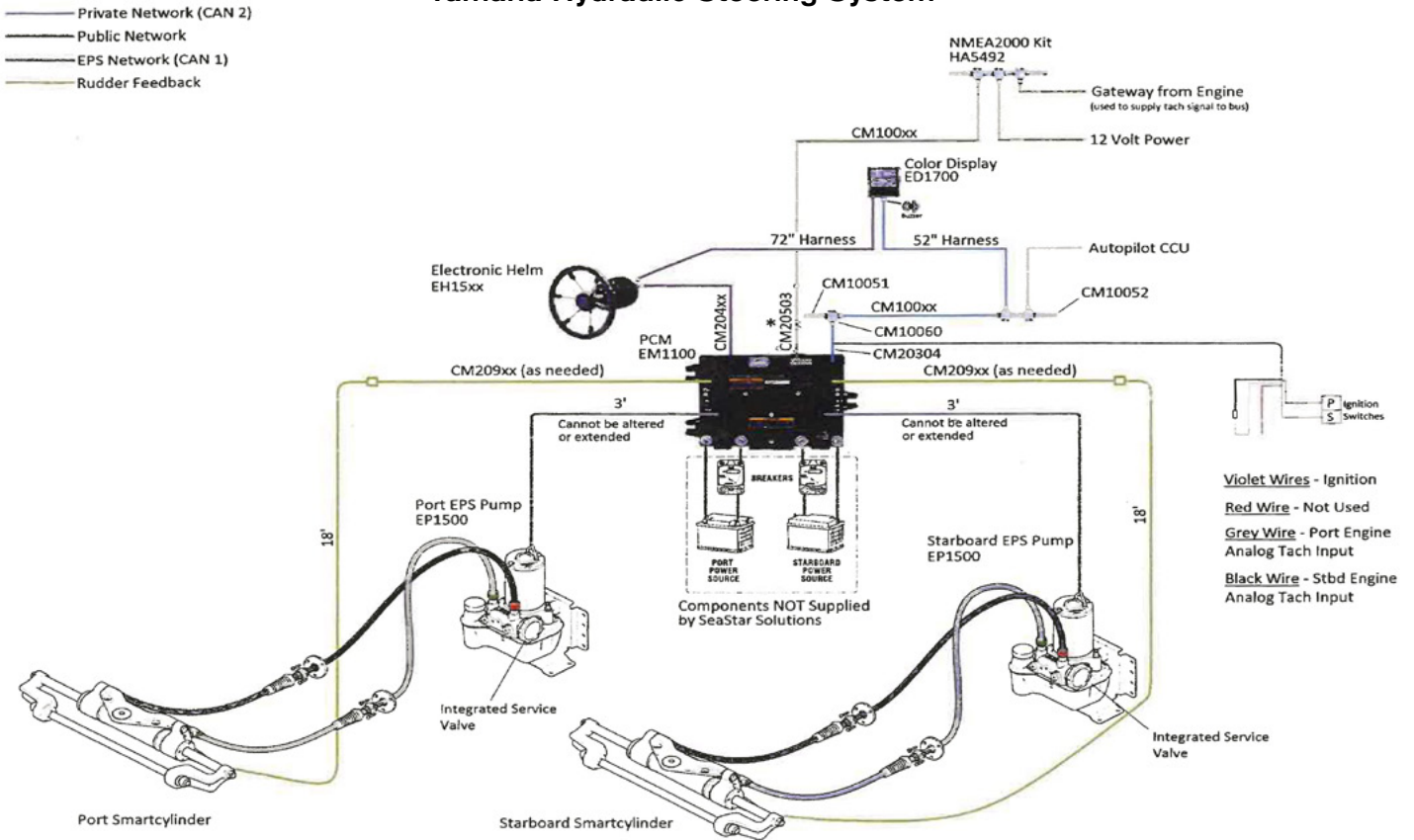

## Electronic Helm

The electronic helm features a sport steering wheel and several tilt positions for maximum control taking into account individual driver needs and body types. The steering wheel motion can be adjusted to various lock to lock turning positions, along with the ability to adjust wheel friction tension through the cruising rpm range to afford the greatest driver control and feel at the helm.

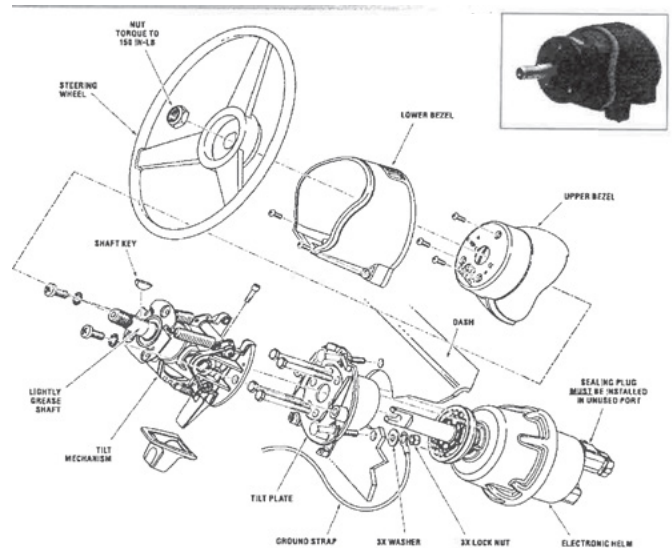

## Power Steering Wiring

The electronic power steering is an on demand system using minimal power. The system uses two 60 amp breakers (one per starting battery) located near the battery source. The breakers are between each battery (twins) and the PCM mounting board. The illustration below shows a typical twin engine steering setup.

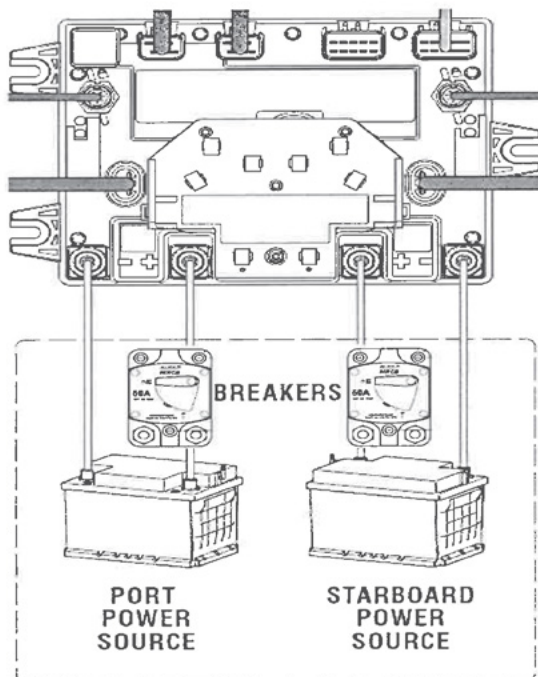

## Hydraulic Steering Pump



Located in the Lazerrete compartment is the steering system hydraulic pump system. Each pump controls the port or starboard steering cylinder. The Yamaha hydraulic steering system uses HA5482 EPS power steering fluid. Do not use any substitutions. It is a good idea to have extra fluid, funnel and cloth on board for emergency filling of the system. Also, note that there is a service valve located on each pump. It allows for manual realignment of the engines during service or a system fault. Use the decal information as needed for manual realignment situations. Engine(s) must not be running while performing these realignment procedures.

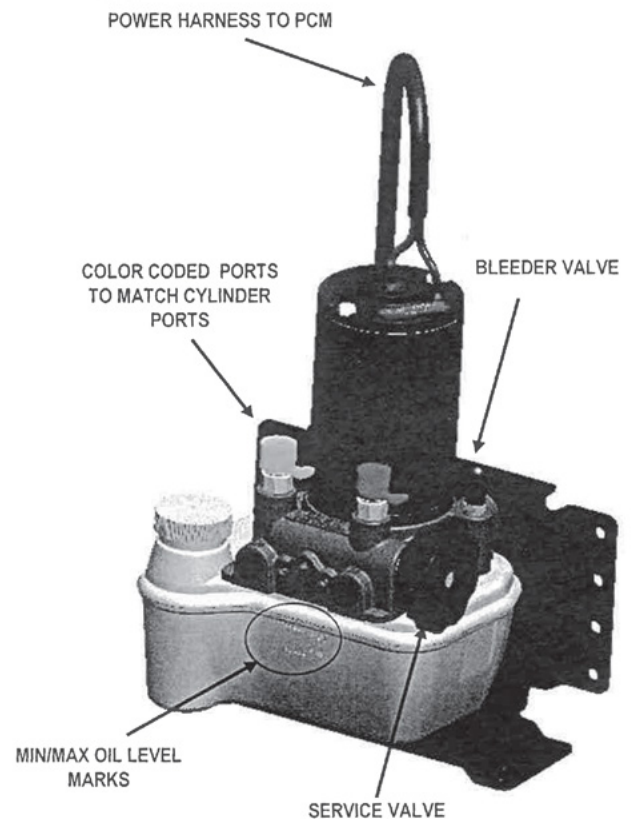

## Smart Cylinder

Located on the engine front is the steering “smart cylinder”. It is foot printed with redundant sensors to determine the steering response to the wheel movement. If one sensor should fail there are back-up ones on each cylinder. The stainless steel cylinder includes ORB fittings with bleeders to purge air as needed.

## Smart Cylinder Description

For information purposes components used in the smart cylinder are shown in the drawing. This illustration may be useful too for ordering needed parts as well as a troubleshooting breakout. Contact your closest Regal dealer to order parts.

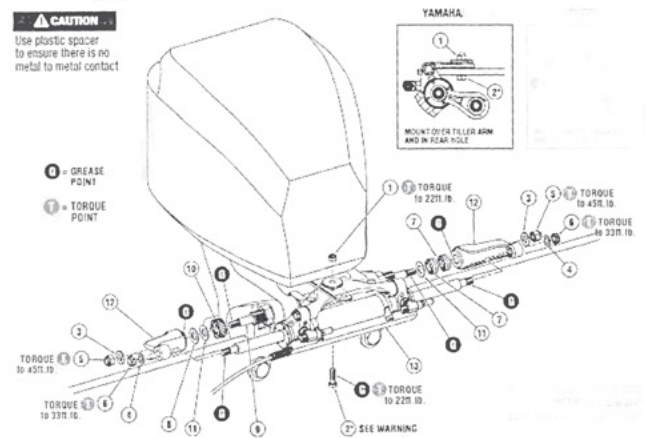

Figure 2-11

ITEM	PART #	QTY	DESCRIPTION
*1	112529	1	Nut, 3/8" NF Nylok® SS
*2	113225	1	HHCS 3/8" UNJFX 1.35 HSS
3	731625	2	Washer, Flat, 7/16" SS
*4	731720	2	Nut, 7/16" NF Nylok® SS
5	202027	2	Washer, Flat, 1/2" SS
*6	192126	2	Nut, 1/2" NF Nylok® NI Plate Br
7	995876	2	Spacer, Thick
8	996689	1	Spacer, Thin

ITEM	PART #	QTY	DESCRIPTION
9	730229	1	Support Rod
10	828085	1	Adjusting Nut & Screw, SS, Teflon Coated
11	202300	2	Washer, Flat, 5/8" SS
12	839120	2	Support Brackets
13	907099	1	SmartCylinder (EC5310) or 907033 SmartCylinder (EC5340)
14	728994	1	Spacer, Medium (size 1995 to 1998)
15	113350	1	HHCS 3/8" NF x 1-1/2" SS



# Chapter 6

## Vessel Operation

### Getting Underway

#### Pre-departure Questionnaire

- Have all fluid levels been topped off?
- Is the fuel tank full?
- Is all safety equipment accounted for and easily accessible?
- Are navigation lights and horn operating properly?
- Is the bilge free of water and does the bilge pump operate?
- Is the outboard engine and propeller in good working condition?
- Is the drain plug in place ?
- Have all passengers been briefed on emergency procedures and seated for departure? Is the boat load balanced?
- Is the operator sober, alert and ready to skipper the vessel?
- Have all passengers been fitted for life jackets?
- Has a float plan been filed and left with a component person?

- Has the bilge been sniffed and the fuel system leak checked?
- Are sea cocks open (if applicable)?
- Is all communication equipment in good operating condition?
- Has a second person been briefed on operational procedures should the skipper become disabled?
- Are all gauges and electrical switches functioning properly?
- Has weather information been gathered and analyzed?

#### Underway Questionnaire

- After casting off have all dock lines and fenders been stowed?
- Are all passengers seated and all doors closed and latched?
- As skipper are you monitoring the dash gauges and/or Garmin plotter for changes?
- As skipper are you on the lookout for changing weather?
- Is the remote control safety lanyard tightly secured to your belt or clothing?

## Disembarking Questionnaire

Have you removed the keys from the ignition and secured them?

- Have all systems been checked for leaks?
- Have the battery switches been turned to the “off” position on the display panel?
- Are all sea cocks closed (if applicable)?
- Has the fuel tank been filled enough to prevent condensation?
- Is the vessel properly tied and covered with equipment stored?

## Fueling

 **DANGER**

AVOID SERIOUS INJURY OR DEATH!  
GASOLINE IS HIGHLY FLAMMABLE  
AND EXPLOSIVE MATERIAL.  
PRACTICE “NO SMOKING” AND EXTINGUISH  
ALL FLAMMABLE MATERIALS  
WITHIN 75 FEET  
OF THE FUEL DOCK

 **WARNING**

AVOID INJURY OR DEATH FROM FIRE  
OR EXPLOSION  
RESULTING FROM LEAKING FUEL!  
INSPECT ENTIRE FUEL SYSTEM AT  
LEAST ONCE PER YEAR.

 **WARNING**

SINCE GASOLINE IS AVAILABLE  
IN SEVERAL GRADES  
INCLUDING ETHANOL AND VARIOUS  
OCTANE LEVELS, REFER TO THE ENGINE  
MANUFACTURER'S OWNER'S MANUAL FOR THE  
CORRECT GAS TYPE/GRADE.  
USING THE IMPROPER OCTANE LEVEL  
OR THE WRONG GASOLINE TYPE CAN CAUSE  
ENGINE DAMAGE AND VOID THE WARRANTY!

### Before Fueling

- Make sure a working fire extinguisher is available.
- Stop engines and any device that can cause a spark.
- Disembark all passengers and crew not needed for fueling.
- Fuel if possible during the daylight hours.
- Check to ensure nobody is smoking in the boat or near the fueling dock.
- Close all portholes, hatches and doors to keep vapors from blowing aboard and settling in the bilge.
- Tie up your boat securely at the fuel dock.
- Identify the fuel fill. Unfortunately, people have mistakenly filled the water or waste with fuel.
- Visually inspect all fuel system components before each filling.
- Avoid using fuels with E-15 alcohol additives. It can attack fuel system parts along with hoses and cause deterioration.

## During Fueling

- Keep the fuel nozzle in contact with the fuel fill to guard against static sparks. The fuel fill pipe is grounded through the fuel system wiring to protect against static electricity.
- Avoid overfilling the fuel tank. Leave room for expansion. Also, if fuel exits the fuel vent indicating the tank is full, this situation is dangerous and unfriendly to the environment.
- Avoid spilling any fuel. Clean up any fuel accidentally spilled with a clean rag and dispose of it on shore.

## After Fueling

- Close all fuel fill openings tightly. Use a fuel key if needed.
- Open all portholes, hatches and doors if applicable.
- Sniff in the bilge and engine area for gas fumes. If fumes are detected continue to let the area ventilate until the odor is gone. Look for any traces of fuel droplets or spillage. Do not start the engine(s), smoke or run any electrical components until the fumes can no longer be detected and the source of the fumes is found and corrected.

## Dock Line Basics

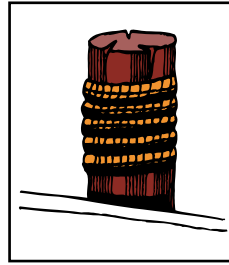

Most skippers use dock line terminology fairly loose but there is more to the basics than just bow or stern lines. There are several lines that can be secured to the bow and stern and depending on their direction and use, can be called other names. Remember that “forward” and “aft” refer to the direction that a spring line runs from the vessel, and not where it is secured on board.

## Bow/Stern Lines

There is only one true bow line. It is secured to the forward cleat and run forward along the dock to prevent the vessel from moving to the stern. The stern line leads from a rear cleat to a piling or cleat on the dock astern of the vessel. This line keeps the boat from moving ahead. For small vessels these are the only lines needed for normal wind and current conditions. If located in a tidal environment, keep slack in the lines.

## Breast Lines

These lines are attached to the bow and stern that lead to nearly right angles from the center of the vessel to the dock. They help keep larger vessels from moving away from the dock, or are pulled in to help people board the vessel. Larger vessels may use bow or quarter breast lines.

## Spring Lines

Most small boats use two spring lines although it is possible to have four. They are called the after bow spring and forward quarter spring.

Bow springs are secured at the vessels bow area.

Forward spring lines lead forward from the boat to the dock and control movement toward the stern. After springs stem aft from the vessel, and stop movement ahead. Spring lines are used to prevent movement in a berth, ahead or astern. They are really useful in controlling the effects of a real active tidal surge. Spring lines are useful where fenders need to be kept in place against piles.

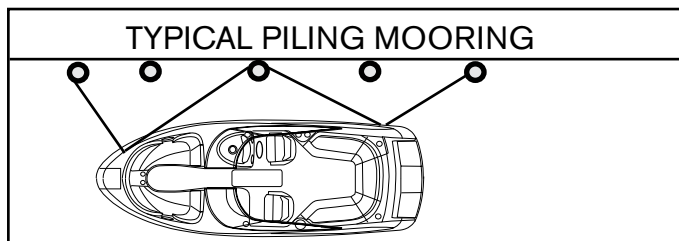
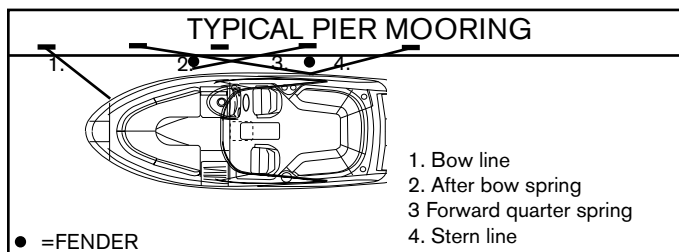

## Boat Mooring

Most boats can be secured to a dock using four lines. The after bow spring line is crossed with the forward quarter spring and secured to individual dock cleats or pilings. This ensures longer springs and can be snugged up tighter for more efficient tidal control.

Remember, if you only have one piling available, position the vessel so this point is opposite amidships. Run both spring lines to it. These lines will be shorter but still useful. The bow and stern lines should be relatively at a 45 degree angle with the dock. The stern line can be attached to the near-shore quarter cleat, but will work more efficiently to the offshore quarter cleat. The longer line will allow the boat flow with the tide with less time checking the vessel.

## Dock Line Sizing

Most dock lines today are made of nylon, either of twisted rope or braided core and cover. The most often used material is nylon because of its stretching abilities absorbing shock loads. It is chafe resistant for extended life and is easier on bare hands.

The line's size varies with the vessel. Normally, a vessel in the 20' to 40' boats will use 1/2" diameter nylon lines. Larger yachts use 5/8" and 3/4" diameter nylon lines. Smaller boats can use 3/8" nylon lines.

Dock lines need to have the strength to hold the vessel and have enough density to resist chafing. They shouldn't be too heavy that they lose their shock-absorbing capabilities. Use the right size line for the vessel since a line too large for the boat will pull hard against the vessel since it won't be forced to stretch. If the line is too small for the vessel, there is no margin for wear and chafe when under strain.

## Securing Dock Lines

When mooring your boat, make sure the dock lines are secured at both ends. Depending on your situation you may need to loop the eye splice of the dock line around a piling.



Sometimes the mooring line will lead down sharply from the piling to the deck cleat. Loop the eye splice around the piling twice to keep it from being pulled up off the pile.

Pull the line through the looped eye if the mooring line is too small to go around the piling twice or too small to fit over once.

If you must drop a line over a piling that already holds another boat's line, run the eye of the line up through the first eye from below, then loop it over the pile. This will allow either line to be removed without disturbing the other. If another line is dropped over yours, simply reverse the process. Secure a little slack in the other dock line, then slip your eye up through its loop and over the top of the pile. Your line can be dropped through the other eye.

When debarking from a dock, it is easier to release the line from a cleat or piling, from on board the boat, as soon as you leave the dock. Loop a long line around the cleat or pier and leading both ends on board you can release the line easily. Slip one end around the cleat or pile, then pull it back on board. Release the line without the eye splice, so it will run freely from around the pile without hanging up on the splice.

## Fenders

Fenders are normally made of a rubberized plastic and are usually filled with air. Most have a fitting like a basketball so they can be inflated or deflated. Fenders are available in a wide range of sizes and shapes to fit both small and large vessels. Fenders are normally designated in inches. They are used between piers, docks, sea walls and the boat.

They protect the top sides of the boat from rubbing against rough objects. Most fenders have eyes of attachment which allow a line to be inserted vertically or horizontally. This will permit the fender to be tied off to fit a variety of marina, dock and tidal situations. Be sure the fender is correct for the vessel size. It is a good idea to carry extra fenders but half a dozen is normally an acceptable number. Remember to store fenders on board so they can be easily accessed. Some people incorrectly call fenders "bumpers".

Note that optional fender clips are available for your vessel.



There is a variety of fender styles and types, each selected for specified uses. When choosing fenders, contact a marine dealer or supply house. Explain how you moor and use your vessel so they can recommend the best fender type for you. We suggest the type with a fill plug so you can inflate them with a hand pump like the ones used for bicycles.

## Maneuvering

Directing propeller energy (thrust) makes slower speed maneuvering easier. The propeller discharge current is turned from one side to the other which results in turning forces. Rudder boats need water to flow by the rudder to be efficient. Drive units are designed to have reduced shaft angle, so the propeller does not produce as much unequal blade thrust and resistance. Large horsepower boats do produce more thrust and steering torque but your vessel has the advantage of assisted power steering.

## Gathering Headway

When a vessel is not moving forward or reverse in the water and the propeller is not turning, (shift in neutral) the boat will not react to the helm steering wheel.

As soon as the vessel is shifted into forward gear propeller action creates a discharge motion and generates energy in the form of thrust. If the outboard drive is centered, the discharge motion is directed straight back causing the vessel to advance forward.

You may notice that if you advance the throttle quickly in initial take-off (make sure you have a firm grip on the wheel), the boat has a tendency to pull the stern of the vessel to port or starboard. There may be a trim tab (also serves as a sacrificial anode) located on the drive housing. This trim tab helps compensate for the low speed steering torque. Once the boat increases headway and the propeller is operating in a faster water flow this torque effect decreases.

Sometimes on select outboards the trim tab may need adjustment. Contact your Regal dealer for further information or consult your engine manufacturer's manual.

## Turning

Once the boat has gathered headway, with the boat planing at the correct bow angle and with the drive unit and helm straight the boat tends to stay on a uniform course heading. To assure the boat trim angle is correct use the chart plotter screen trim gauge as a guide while activating the trim button on the remote control panel.

When the helm wheel is turned to the right or starboard, the drive unit is turned in the same direction. The propeller's discharge force is directed to starboard forcing the boat's stern to port. Water flowing past the hull strikes the stern drive gear housing in its starboard side, creating additional turning torque. The stern starts a move to port, forcing the bow to starboard.

If the helm is turned to the left or port the drive turns to port, the stern of the boat goes starboard as the bow turns to port.

As the vessel operator gains experience, he will better gauge each maneuver and speed situation. In this way he will understand the handling characteristics of his boat. He needs to keep the safety of his passengers in the highest priority.

## Backing Down

If your boat has the steering wheel and drive straight with the control in reverse, the stern will be pushed a bit to port by the reversing propeller thrust. This tendency to back to port can be eliminated by turning the drive to starboard.

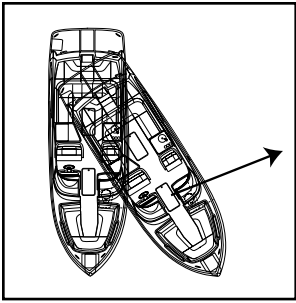

When the vessel begins to gather speed to stern, the water passing by the lower gear case housing will continue to increase steering torque. If the helm wheel is turned to

starboard, and will direct the propeller thrust to port, tracking the stern to starboard.

Wind and current will affect how a vessel backs. Select boats tend to be light displacements and when backing down in a strong crosswind, the bow will tend to fall toward the windward. This may cause steering problems.

### Stopping

Remember that your boat does not have any brakes. It uses reverse thrust from the propellers to stop. If the vessel has headway, with the helm and propeller in reverse the propeller thrust is directed backwards, past the lower gear case. Depending on how far the throttle is advanced, the discharged thrust may not be strong enough to reverse the water flowing by the gear case. As the power is increased, the propeller thrust becomes strong enough to stop the flow of water past the lower unit, and, as the throttle is advanced it reverses its flow more completely.

When water is flowing past the gear case, steering torque is increased, but when the thrust stops the water flow, the boat will not respond to the helm. This is a short lived event and is overcome quickly when the water again flows past the gear case. Furthermore, added to the energy of the water hitting the lower gear case, the propeller thrust is directed by turning the drive unit which can add to the steering torque.

The prop tends to throw the stern to port. This is why experienced skippers undertake a port side landing when wind and current conditions permit. They allow the prop to move the stern to port toward the dock. With a forward motion when the helm wheel is turned hard to one side, the vessel pivots around a point about 1/3 its length abaft to stern.

### Docking

When docking twin engines it is recommended to use both engines. Most docking situations can be accomplished by working the control levers back and forth in gear without the use of additional throttle positions.

There are times when wind and/or current may demand the use of port or starboard control handles to increase idle throttle a bit to maneuver in tight situations.

## Power Trim/Trim Tabs

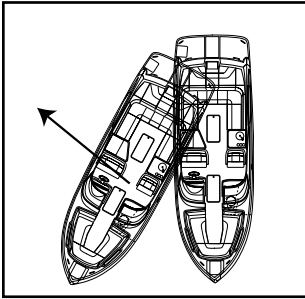

Both stern drive and outboard boats have the ability to angle in or out their drive unit in relationship to the transom. This is accomplished by hydraulic shocks located

along with an electrical sender unit that reads the drive angle and sends information to the chart plotter showing a reading.

### Purpose of Power Trim

The purpose of the power trim/tilt is to enable the operator to change the angle of the drive while at the helm. Changing the angle of the drive or “trimming” provides the following benefits:

1. Improves acceleration onto a plane.
2. Maintains boat on plane at reduced throttle settings.
3. Increases fuel economy.
4. Provides smoother ride in choppy water.
5. Increases top speed.

In short, it is a way of fine-tuning the performance of your boat and will enable you to get the most efficient and comfortable ride possible, whatever the conditions.

### Using Power Trim

The power trim is normally used prior to accelerating onto a plane, after reaching the desired RPM or boat speed and when there is a change in water or boating conditions.

Position passengers and equipment in the boat so that the weight is balanced correctly fore and aft as well as side to side. Trimming will not compensate for an unbalanced load.

To operate the trim, push the switch until the desired bow position is reached. The trim may be operated at any boat speed or at rest. Avoid operating the trim system when running in reverse. Observe the trim/tilt gauge which indicates the boat's bow position achieved by the trim angle of the vertical drive unit. “Bow-Up” corresponds to the upper portion of the trim range on the gauge while “Bow Down” corresponds to the lower portion of the trim range on the gauge.

To determine the proper trim angle, experiment a little until you are familiar with the changes in your boat. The vessel will be properly trimmed when the trim angle provides the best boat performance for the particular operating conditions. A trim position that provides a balanced steering load is desirable. To familiarize yourself with the power trim, make test runs at slower speeds and at various trim positions to see the effect of trimming. Note the time it takes for the boat to plane. View the chart plotter screen, tachometer and speedometer readings as well as the ride action of the boat.

### Operation In “Bow Up”

The “Bow Up” or out position is normally used for cruising, running with a choppy wave condition, or running at full speed. Excessive “bow up” trim will cause propeller ventilation resulting in propeller slippage. Use caution when operating in rough water or crossing another boat's wake.



Excessive “bow up” trim may result in the boat’s bow rising rapidly, creating a hazardous condition.

#### Operation In “Bow Down” Position

The “Bow Down” or in position is normally used for acceleration onto a plane, operating at slow planning speeds, and running against a choppy wave condition. It is also used when pulling water skiers, tubers, knee boarders, etc. In this position the boats’ bow will want to go deeper into the water. If the boat is operated at high speed and/or against high waves, the bow of the boat will plow into the water.

#### Operation In ‘Level” Position”

In normal running conditions, distribute passengers and gear so boat is level. At or below cruising speeds, trim the vessel for optimum performance. The trim gauge will show somewhere in the center of the gauge. This position will also enhance running visibility and overall stability. Again, each outing provides different wave, load and running conditions. Be prepared to make trim changes as needed.



## CAUTION

THE BOAT TRIM SHOULD BE ADJUSTED TO PROVIDE BALANCED STEERING AS SOON AS POSSIBLE EACH TIME YOU GET UNDERWAY. SOME BOAT/ENGINE/ PROPELLER COMBINATIONS MAY CREATE BOAT INSTABILITY AND/OR HIGH STEERING TORQUE WHEN OPERATED AT OR NEAR THE LIMITS OF THE “BOW UP”OR “BOW DOWN” POSITIONS. BOAT STABILITY AND STEERING TORQUE CAN ALSO VARY DUE TO CHANGING WATER CONDITIONS. IF YOU EXPERIENCE BOAT INSTABILITY OR HIGH STEERING TORQUE SEE YOUR AUTHORIZED REGAL DEALER.

### TRIMMED "TO FAR IN" POSITION



### TRIMMED "TOO FAR OUT" POSITION

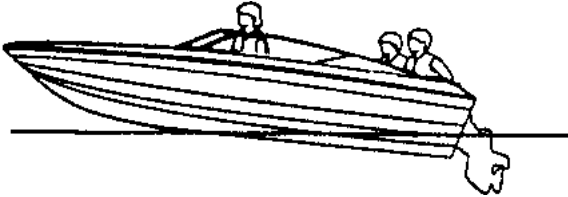

### WELL TRIMMED "LEVEL" POSITION

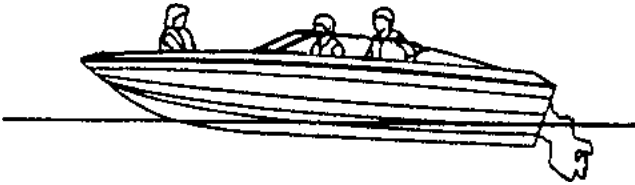

### Shallow Water Operation

Operating your vessel in shallow water presents various hazards. You are more apt to hit a submerged object such as a rock, sand bar, stump coral, or other unmarked objects.

Pay close attention to your charts for descriptions of any shallow areas along with marked submerged objects. Always post a lookout when operating in shallow water. Trim your drive up as needed to provide adequate draft. Set the alarm on your depth sounder and travel at a speed that will keep the boat level in these shallow areas.

***If your boat strikes a submerged object stop immediately and check for hull, drive, and propeller damage.***

Typical Trim Angle Generic Examples Above

## Anchoring

Selecting the correct anchor is an important decision. The anchor style in part depends on the usage and boat type. Regal boats designate an anchor type and or model. Some models incorporate chain, line with an optional windlass. Contact an authorized Regal dealer for more information.

Anchoring is easier with another person on board. First be certain that the line for the anchor is properly attached, to avoid losing the anchor and anchor line overboard.

For most anchors to perform more efficiently, you should attach 3 to 6 feet of chain. The chain will stand up to the abrasion of sand, rock, or mud on the bottom much better than a nylon line. It should be galvanized to reduce corrosion. Next, attach a length of nylon line to the other end of the chain. The nylon will stretch under a heavy strain cushioning the impact of waves or wind on both the boat and the anchor.

To anchor, select a well protected area, preferably with a flat bottom. Contrary to modern belief, you do not throw the anchor over while the boat is making headway, or moving forward. In fact, the bow of the boat should be brought slowly backward, while easing the anchor slowly over the side of the boat until it hits the bottom. To “snub the line” means to stop its outward “pay” or movement. Usually the length of anchor line used should be 5 to 10 times the depth of the water.

After you have anchored, check your position with landmarks if possible. You need to continue to monitor landmarks to make sure you are not drifting.

Since anchoring can also be an emergency procedure, the anchor and line should be readily accessible.

For increased holding power in windy conditions, two anchors are sometimes set. If your primary anchor drags, you can run out your secondary anchor without picking up the primary one. The important thing is to lay them out at an angle. When setting two anchors, make sure they are fastened to separate rodes or cleats. This is done in case you need to adjust one later so the line is accessible. If two anchors are used ahead of a boat, make sure to set the rodes at an angle than in a straight line to reduce the chances of tangling as the boat moves in wind and current. See the illustration.

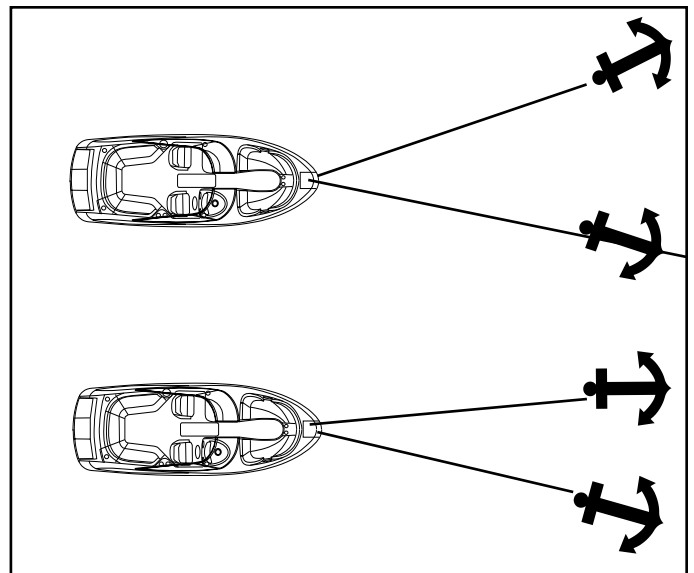

## The Law Of Salvage

The Admiralty law sometimes referred to as the salvage law was founded primarily on English law fundamentals and basically says that a vessel distressed, in danger of flounder, if rendered assistance from a towing company or private agency, can be forced to relinquish a portion of the vessels' worth for the assistance received.

# NOTICE

IN THE EVENT  
YOUR VESSEL IS IN DISTRESS,  
PRIOR TO ALLOWING ANY TOWING  
COMPANY OR PRIVATE AGENCY THE  
RIGHT TO PASS A LINE TO YOUR VESSEL,  
BE SURE TO ESTABLISH THAT YOU  
DO NOT AGREE TO SALVAGE RIGHTS.  
ESTABLISH WITH THE CAPTAIN  
OR OPERATOR THAT YOU WISH TO BE  
ASSISTED IN A CONTRACT BASIS AND  
ESTABLISH A PRICE.  
OF COURSE IN CERTAIN SITUATIONS,  
YOU MAY NOT HAVE THIS OPTION.

USE YOUR BEST JUDGEMENT!

## Towing

In case you find yourself aground or in need of a tow, or should you want to tow another vessel, keep in mind that it is best never use deck hardware or cleats to secure lines for towing!

Deck hardware is intended for mooring and anchoring, and is not designed to withstand the strain and pull of towing. Rather than tie the line to your cleats on deck, it is suggested that you tie a bridle by passing a line completely around the hull of your boat to avoid damage.

When towing, always stand clear of a taut line, as any type of line breaking under stress can be extremely dangerous. The preferred line for towing is double-braided nylon, as it has sufficient elasticity to cushion shock loads. Move slowly and cautiously.





# WARNING

AVOID INJURY OR DEATH!  
DO NOT USE DECK HARDWARE  
INCLUDING CLEATS  
FOR TOWING.

## Knots

Knots are useful in docking, towing and other emergency situations. Learning to tie knots requires practice. As they say “ Practice makes perfect”. Some of the knots used in boating are the square, bowline, anchor bend, clove hitch, figure eight and half hitch. There are several periodicals available that explain various knots and how to tie them effectively. An experienced skipper will know the basic nautical knots and will use them when on the water. Take the time to know the basic knots.

**Figure 8 Knot  
Tied To Cleat**



A useful knot to learn for general docking is the figure eight with one end reversed. By turning the free end of the line back under, the knot can be released without disturbing the boat. After some practice one person can secure a vessel easily to a dock or pier in a variety of weather conditions. This knot normally is used to tie the bow and stern. Then the vessel can further be fastened by tying the spring line in the figure eight knot. Wrap it around the cleat 2 or 3 times.

## Emergencies

Always be ready to help others on the water if possible, but do not take any unnecessary risks. Use equipment to save a life, but do not risk a life to save equipment. Consult earlier information in this manual concerning accidents, etc. Also, read other literature concerning on the water emergencies. Be alert and prepared!

## Fires

Fire aboard a vessel can spread quickly and can cause tremendous alarm among everyone. Most fires can be prevented by keeping the bilge free from oil and debris. Keep all equipment stowed and maintained in working order. Carry a backup fire extinguisher on board. If something becomes a possible fire hazard, remove that possibility at once. Never use water on gasoline, oil or electrical fires. When you dump water on an electrical fire you can be shocked since water conducts electricity.

Follow these instructions if a fire breaks out:

- A. Fit everyone aboard with a life jacket. Turn off the ignition.
- B. Try to keep the fire downwind. If the fire is to the stern, head the bow toward the wind. If forward, put the stern to the wind.
- C. If the engine should catch fire, shut off the fuel supply. Usually there is a fuel tank access that you can crimp the fuel feed line.

D. Use a hand fire extinguisher. Make sure to point it at the base of the flames. Use short bursts and sweep the extinguisher side to side.

*Note that a 4 lb. extinguisher discharges in approximately 20 seconds.*

These actions help prevent the fire from spreading to other parts of the boat. You can extinguish fires quickly if you act swiftly. Have a plan of action in motion in case a fire breaks out.

## First Aid

Knowing first aid can save lives. A first aid kit and the ability to use it are important ingredients for the safety of a skippers' passengers, crew and vessel. Having confidence and competence in handling medical emergencies on board is a must for the skipper. Invest your time in a first aid course available at the American Red Cross.

## CPR (Basic Life Support)

If a person is seriously injured have someone call for help while the injured person is being attended.

Check for possible danger signs; loss of breathing, unconsciousness, severe bleeding and heartbeat. If you determine the individual is not breathing or unconscious place the victim on their back on a hard surface and do the following:

1. If unconscious, open the airway. Neck lift, head lift or chin head lift.

2. If not breathing, begin artificial breathing. Pinch the nose. Give 4 quick breaths. If airway is blocked, try back blows, abdominal or chest thrusts and finger probe until airway is open.

3. Check for pulse. Begin artificial circulation. Depress sternum 2".

15 compressions rate 80 per minute. 2 quick breaths. Continue uninterrupted until advanced medical support is available.

## **Follow up immediately with medical authorities!**

## Hypothermia

Hypothermia is a condition where the body temperature decreases because the body can't generate enough heat to maintain its normal temperature. It can be serious and usually occurs where victims have been immersed in water (under 68 degrees) for extended periods of time. If you encounter a possible hypothermia victim call for help on the radio and get the person out of the water.

Symptoms are:

1. Shivering that if condition is advanced may stop.

2. Confusion, clumsiness or slurred speech.

3. Rigid muscles.

4. Semiconscious to unconscious.

Treat hypothermia by the following:

- Remove wet clothing.

- Monitor the victim's pulse and breathing.
- Rapidly apply heat to the body core by using blankets, naked bodies or warm water.
- Do not give the person any food or drink.
- Do not warm the arms and legs. Warming of these extremities can be fatal.

Follow up immediately with medical authorities!

### **Environmental Awareness**

There are numerous vessels operating on our waterways on a daily basis. Each boat has an impact on our environment. Boat operation habits, marine sanitation, and maintenance all play a role in a delicate battle to keep the ecosystem clean. Each of us has a role in doing our part as an environmentally conscious skipper to conserve our waterways.

The National Marine Manufacturer's Association lists their top ten of Eco-Boating Practices as follows:

1. Observe all regulatory agency policies regarding marine toilets.
2. If equipped with a holding tank, use marina pump-out facilities.
3. If used, make sure bottom paints are legal and ecosystem friendly.
4. Use only biodegradable cleaning agents.
5. Dispose of all garbage and litter on shore properly, not on the water.
6. Don't top off fuel tanks. Leave expansion room. Clean up spills.

7. Watch your wake and propeller wash.

8. Make sure your engines are well tuned and maintained.

9. Control your bilge water.

10. When fishing, practice the "catch and release" principle.

**Follow these basic practices when on the waterways. Treat the environment in a way that you would like to be treated.**

# Chapter 7

## Auxiliary Equipment Operation

### Overview

This chapter will assist the boat operator in understanding selected standard and optional equipment components on the vessel. *Select equipment described may not be installed on your boat or the pictorials may not exactly resemble equipment on your craft.* Remember, Regal is constantly improving its product line and therefore may make changes in vendor parts and specifications without notice.

For detailed information on equipment, please refer to the owner's information packet.

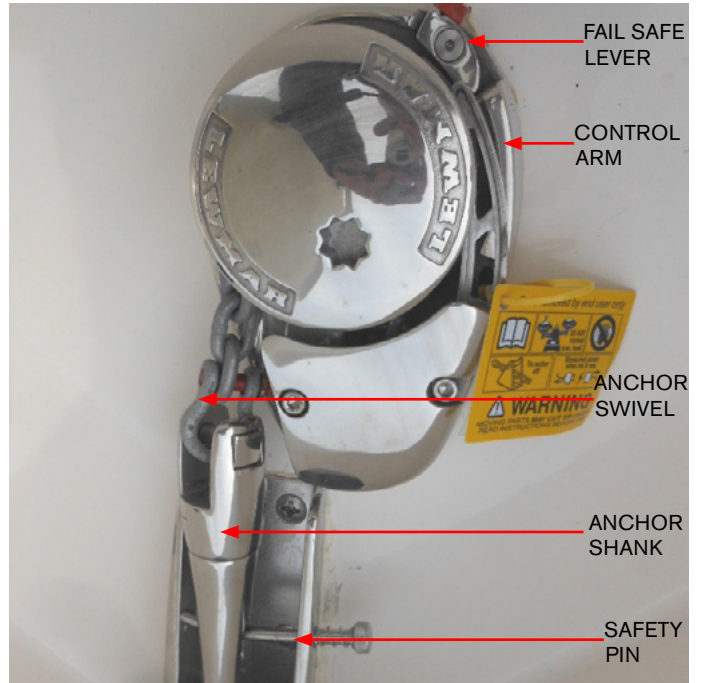

### Anchor Windlass (Typical)

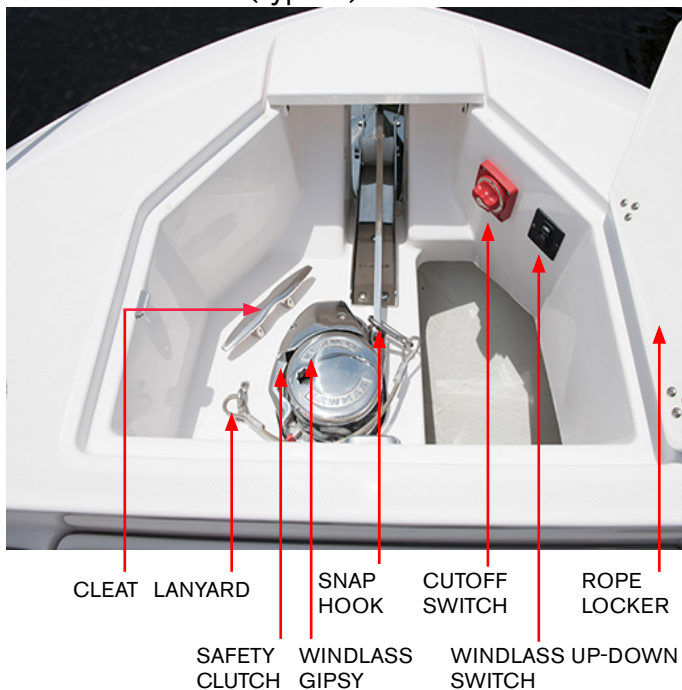

### Anchor Windlass Introduction



The windlass features a stainless steel polished "claw" style anchor complete with swivel. Claw's include high holding power in most seabeds.

A momentary windlass rocker switch located at the anchor locker controls the lowering and retrieving of the anchor through the windlass. A 50 amp breaker for windlass over current protection is located at the battery management panel. There is a lanyard with a snap hook to add holding power when the anchor is in the stored position. The cleat is for tying off the anchor rode rather than maintaining constant pressure on the windlass itself.



Note: Never use the windlass to break the anchor free from the bottom. This may cause excessive strain on the windlass motor and or hardware.

### Using Anchor Windlass

The windlass may be outfitted with a rode using 100' of 1/2" nylon rope along with 10' of galvanized chain. The chain is connected to the anchor shank which is next to the anchor. The chain acts as a safety margin to protect the rope rode from being damaged by sharp seabed objects such as coral that might sever the rope if it was next to the anchor.

**Note that all chain windlasses use a chain stopper to remove tension from the windlass itself.**

If needed for harsh sea bottoms the rode can be converted over to 100' of 6 mm galvanized chain with a small length of rope at the top for tying off the rode to a cleat.

The safety clutch is used to "pay out the windlass chain or to retrieve the anchor "rode". There is a handle in the anchor locker that inserts into the gypsy drive cap located on top of the windlass framework.

With the handle inserted in the cap, turn the handle *clockwise* which grips the "gypsy", locks it and **tightens the clutch**. Remove the handle and store it after usage.

To **loosen the clutch** with the handle inserted in the cap, turn the handle *counterclockwise* which will free up the "gypsy" from the drive train. Remove the handle and store it.

Before attempting to "pay out" the anchor **ensure that the fail safe pawl is disengaged from the gypsy and held clear of it by the fail safe lever**. See windlass owner's manual for further information.

**If installed, be sure to pull the safety pin from the anchor shank before using the system.** *The anchor will not pay out with this pin inserted.* This pin should be reinstalled after each anchor retrieval.



## WARNING

AVOID SERIOUS INJURY!  
ENSURE THAT ALL BODY PARTS & CLOTHING  
ARE KEPT CLEAR OF THE ANCHOR RODE  
AND WINDLASS DURING OPERATION.



## WARNING

AVOID SERIOUS INJURY!  
DO NOT "PAY OUT" ANCHOR UNTIL IT IS  
DETERMINED THAT THERE ARE NO  
SWIMMERS OR DIVERS NEAR THE AREA.

### Paying Out Anchor Using Gravity

To let out the anchor release any anchor locks, insert the clutch handle into the gypsy drive cap and turn it in a clockwise direction to tighten the clutch. When in a safe mode, pull back on the clutch until the anchor and rode begin to pay out. Control the rate of anchor descent by pushing the clutch lever forward. When the desired rode is paid out, tighten the gypsy drive cap.

### Paying Out Anchor Using Power

Make sure any anchor locks are disengaged and the pin through the anchor shank is pulled along with the lanyard hook. Stand clear of all windlass components when paying out. Using the windlass momentary switch, press and hold the lower portion of the switch.

When the proper ratio of anchor rode is paid out disengage the switch and tie off the rode to a cleat since it is not recommended to let the windlass mechanism be the only source holding the rode to the anchor on the sea bottom. Also, do not use the fail safe pawl to hold the anchor load as windlass damage could occur.

#### Hauling In Anchor-Manual Recovery

Insert clutch handle into the gipsy drive cap and turn clockwise until anchor is fully returned to the bow roller.

#### Hauling In Anchor-Using Power

When anchor rode is safe to haul in use the windlass momentary switch to haul in the anchor rode. Press and hold the upper portion of the switch until the anchor is returned to the bow roller position.

The fail safe pawl does not need to be disengaged during retrieval as it will act as a ratchet. When the anchor has been retrieved in the bow roller position the fail safe pawl should be left engaged in the gipsy to prevent accidental activation of the windlass while underway. Also, reinstall the pin through the anchor shank and the lanyard hook. Note that the fail safe pawl does not need to be disengaged from the gipsy before the anchor can be paid out again.

It is recommended that during the paying out process the engines be run to stern before full scope is reached. This will help prevent the rode from being tangled in the anchor on the sea bottom. It is recommended that during the retrieval process to use the engine to gather headway.

Do not let the vessel sit directly on top or over the area where the anchor lies because the chain rode could damage the hull topside.

As the anchor raises toward the scuff plate area, retrieve the last few feet very carefully to eliminate any hull damage.

Once the anchor is retrieved, check to ensure the fail safe pawl is engaged in the gipsy which will help prevent accidental activation.

#### Windlass Safety Tips

1. Read the windlass owner's manual.
2. Keep all body parts and clothing away from an activated windlass.
3. Do not exceed the maximum load designated by specifications.
4. Always tie off the anchor rode to the designated cleat.
5. Do not use the windlass to pull or tow another vessel.
6. Always shut off windlass breaker or main battery switch before servicing the component.
7. Always use engine power to gain headway before retrieving anchor.
8. Always look for swimmers or divers before deploying anchor.
9. Always secure rode/anchor while cruising or pulling vessel on highway.

## Autopilot

If installed, the autopilot is part of the onboard marine network and therefore can be programmed to maintain a course through the chartplotter route. Easy-to-use setup provides carefree auto-guided navigation in open waters.

### Autopilot Operation

The autopilot continuously adjusts the steering on your yacht to maintain a constant heading. The unit can be programmed for both automatic and manual steering functions and patterns.

Before using the auto pilot, be sure to read and understand the autopilot operation manual located in the owner's information packet.

 **WARNING**

TO PREVENT POSSIBLE BODILY INJURY, DEATH OR PROPERTY DAMAGE, NEVER LEAVE THE HELM UNATTENDED. BE PREPARED AT ANY TIME TO PROMPTLY REGAIN MANUAL CONTROL OF YOUR VESSEL.

Follow these steps to start-up the autopilot;

1. Energize the "house" battery switch at the battery activation panel located under the cockpit starboard cushion.
2. Press and hold the power button briefly to turn the autopilot on or off. If the power button is released quickly instead of briefly holding it the unit will seek the display adjustment screen verses the main screen.



### General Operation Keys & Descriptions

**Power-** Turns the autopilot on and off.

**Soft Keys-** These keys help to navigate the menus, select items, and change the autopilot steering bearing. The center soft key is used to select highlighted items and open a menu. The left soft key is used to engage the unit or to move back one screen. The right soft key is used to navigate through the menu screens.

*Note to press a soft key to activate the action indicated directly above it.*

**STBY (Standby)-** Press this button to start the standby function. Press STBY to stop the autopilot from any menu screen at any time. A time when you use STBY might be when you are beginning your route through a tight turning channel to a marina or to your favorite on the water restaurant.

**Note 1:** When you place the autopilot in standby mode be ready to regain manual control of the boat steering system.

**Note 2-** The heading sensor is a device that is integrated in the autopilot system that controls the direction inputs and outputs of the unit.

Status- If you press the STBY button on the heading screen “YOU HAVE THE HELM” appears in yellow cautionary lettering. At this point be prepared to manually take control of the helm steering. Under normal conditions on the heading screen the status reads “AUTOPILOT ENGAGED” in green lettering.

Heading- When you engage the autopilot, it takes over the helm steering control and steers the boat to maintain your heading. This heading can be programmed through the autopilot which uses an on board flux-gate compass for bearings based on a magnetic north verses a true north heading. The autopilot heading can also be programmed through the chartplotter to follow a set of way points.

Actual Heading Marker- A yellow triangle (actual heading marker) is displayed and is normally the bearing you are heading.

Note: If the arrow keys are pressed to manually adjust the heading, the heading dial on the heading screen displays your actual heading while the autopilot steers the yacht to the intended heading.

Pattern- This screen icon shows various steering patterns for fishing and other speciality patterns such as zigzag, circles, U-Turn, and Man Overboard. Read and understand the autopilot owner’s manual description of these patterns and make sure the water is free of obstacles and you have an unlimited area to practice these steering patterns.



## Bilge pump

Before each outing, check the operation of the bilge pump, automatic switch, and manual switch. The bilge pump should automatically activate when water reaches a pre-determined height in the engine compartment. Test the bilge pump manually at the dashboard with the switch. Periodically check for bilge debris around the grates of both the bilge pump and automatic switch, and also bilge pump impeller.

The automatic mode for your bilge pump works similarly to the manual method. Both methods control the bilge pump by a switch, but the automatic mode utilizes a float switch. Float switches feature a device that sits at water level, and when the float reaches a certain height, it trips the switch and activates the bilge pump.

Periodically you may need to disassemble the bilge pump from the grate in order to clean or access the inner mechanisms. To remove the bilge pump, utilize the quick disconnect tabs on either side of the bilge pump, squeezing them like a backpack clip while pulling up on the pump.

For switch control location, refer to the engine and controls chapter. For bilge and drainage system information and electrical system information, refer to the systems chapter. Refer to the vessel operations chapter for pre-departure use.

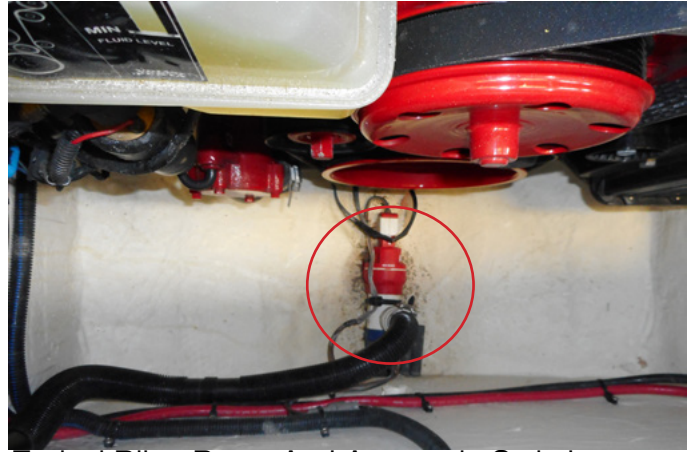

Typical Bilge Pump And Automatic Switch

## Bow Thruster

### General Safety Notices:



1. Be sure to read and understand the safety information and all thruster operation information before attempting to use the thruster system. Refer to the thruster manufacturer's

owner's manual for more detailed information.

2. Do not operate the bow thruster system close to swimmers as a high powered suction is produced at the propellers.

3. Make sure the propeller lock nut is torqued to the required foot pound specification.

### Thruster Usage

To use the thruster first make sure the battery switch is activated. If necessary there is a on/off battery switch in the bilge that is in-line with the thruster power cable feed. Make sure the switch is energized.

NOTE that there is a joystick on the helm. The thruster will assist in slow speed maneuvering especially around a dock or close mooring situations. It operates similar to a gaming or marine propulsion type joystick. To activate the joystick, push and hold the black button. The red icon will illuminate.

Never run the thruster dry; it will weld the relay contacts as it becomes a generator in spool down.

Do not make quick changes from one direction to the other direction, or it will damage the unit. The minimum running voltage for the thruster is 10.5 volts; therefore the outboard engine(s) should be running to maintain this voltage requirement.

There is an in-line ANL type fast activation fuse for over current protection behind the thruster switch panel.



Periodically check the thruster 5 blade propeller located in the forward hull sleeve for damage, debris and corrosion.

Also, if the vessel is left in salt water for extended periods check propeller for marine growth organisms such as barnacles.

## Cabin Entrance Door (Typical)



The companionway door is a lockable slider type engineered with heavy mechanical joints for added strength. The aluminum frame is typically finished in a weather resistant polyester powder coating. The tinted door surface is a high impact acrylic.

*Note that when underway always ensure the companionway door is closed and locked.*

When moored ensure that if the door is left open and the latch at the bottom track is flipped across the track to prevent the door from closing. See photo.

Read and understand the care instructions in the care and maintenance chapter since the door track and rollers may require periodic lubrication.

Note to safely secure an extra door key for emergency use.

## Cabin Entrance /Cockpit Drainage Grates

Located just aft of the door sill is a stainless steel grate cover and a drainage trough. It is a segment of the cockpit drainage system. Water enters through the grate slots and travels through scupper drains and hoses. It is then exited overboard.

Periodically remove the grate and clean any debris from the scupper screens located in the bottom of the drainage locker.

In addition, it is recommended that you periodically ensure all other cockpit drains/ scuppers are free of debris as select seats and components like the anchor locker as drains are integrated into them.

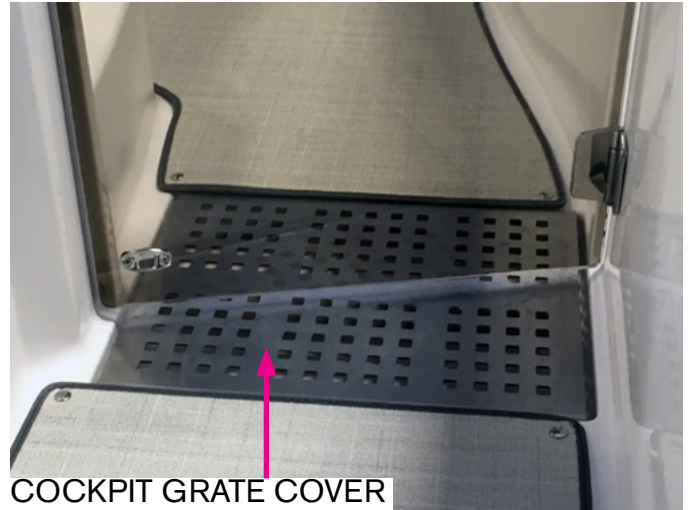

*Note that some cockpit drains use screened covers with circular grids and others use rectangular slots and others use no drain cover. Slotted drain covers tend to exit water at a faster rate and are less likely to clog with debris than finer circular grid drain covers.*

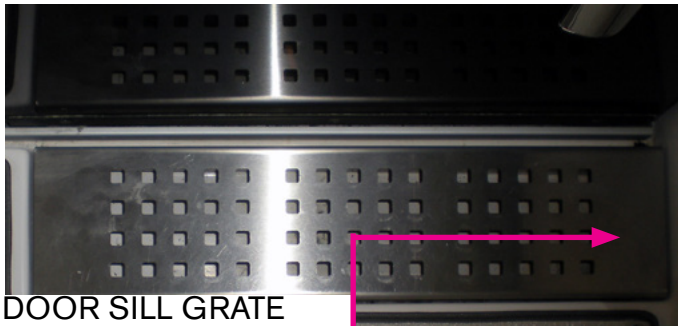

*Note that the cockpit drainage system is an important ingredient when the operator finds himself in high wind and rain environments.*

*Make sure to keep equipment away from the transom door as the majority of all water will flow under the transom door overboard while making headway besides the cockpit scupper drains.*



## Canvas (Typical)

Typically, there is a variety of canvas available for your vessel including a bow cover with cockpit seat cover, manual bow and sunshade covers and possibly a helm enclosure.

Of course any of the above selections will improve the overall comfort and longevity of the parts that they cover. See the care chapter for cleaning information on vinyl canvas types.

*Note that various vessel photos are shown below.*



## Cockpit Grill (Typical)

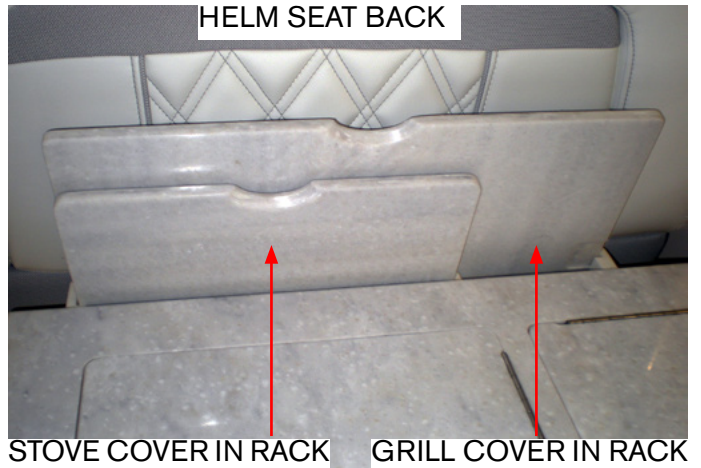

Be sure to read the grill owner's manual to become acquainted with all the safety features and proper modes of operation before operating the grill.

To operate the cockpit grill do the following:

1. You must either be on dock side power or have the generator running as the grill operates at 120 volts.
2. Activate the dedicated breaker on the ship's main AC panel.
3. Next, before energizing the grill controller at the face of the grill cabinet remove the grill cover and insert it into the bow facing slots in the rack behind the helm seat. It will only fit one way. Note that the aft slots are dedicated to the stove cover. See photo. at top right and next page. There is a grill micro switch at the bottom of the slot area of the rack. This micro switch monitors power to the grill controller.



4. Next, locate the grill controller on the face of the cabinet. Push the center button to activate the grill. Change the grilling temperature by using the plus or the minus buttons on the grill control. Always have a fire extinguisher handy.

There is a in-line GFCI breaker located on the grill power cord. Refer to the systems chapter for location and description. Access is provided to the GFCI inside the grill cabinet. It operates like other GFCI components.



## Cockpit Grill (Con't.)

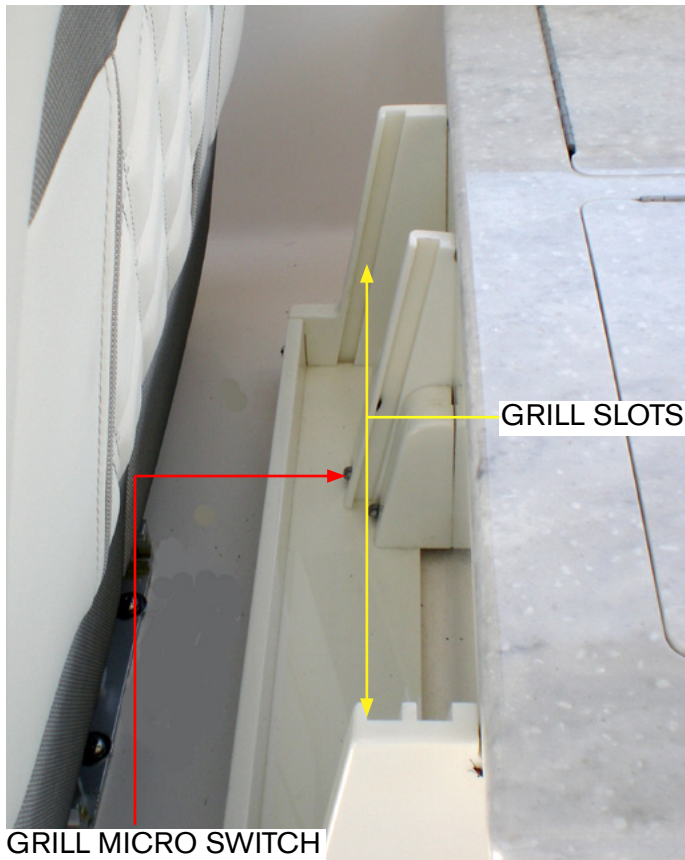

***Note that the grill will not operate without the cover in the dedicated slotted rack.***

***See the photo on previous page for correct cover positioning.***

## Cockpit Grill- Safety Instructions

1. The unit is designed to cook food like meat, fish or vegetables. Do not use it for any other purpose since it could be dangerous.
2. Do not operate the grill in rough seas or high winds.
3. Do not add burning type charcoal briquettes or volcanic stones to the unit.
4. Never operate the grill while making headway (under engine power).
5. Never grill with the canvas in the up position since smoke and odors from cooking could infiltrate the canvas fabric over time.
6. Keep combustible material away from the grill.
7. Keep children away from a hot grill surface.
8. Let the unit cool down before attempting to cover it.
9. Clean grill tray after each use to prevent fires.
10. Keep the grill covered when not in use.

# NOTICE

THE GRILL GFCI BREAKER  
IS ACCESSIBLE BY OPENING THE TOP  
CABINET DRAWER.  
REFER TO THE GFCI PAGES IN THE  
SYSTEMS CHAPTER FOR FURTHER INFO.

Always find the reason for a breaker tripping occurrence before resetting the GFCI breaker.



## Cockpit Refrigerator (Typical)

If installed, the cockpit refrigerator provides chilled and frozen storage areas for food and beverage with a volume of 49 liters or close to 1.75 cubic feet capacity. It features a brushed 316 grade stainless steel door and LED lighting along with an easy reach digital thermostat bank. The bin and bottle racks keep supplies secure in rough weather. Includes a freezer drawer. The unit operates at 12 volts DC voltage and draws approximately 6 amps along with requiring a minimum of 10.9 volts.

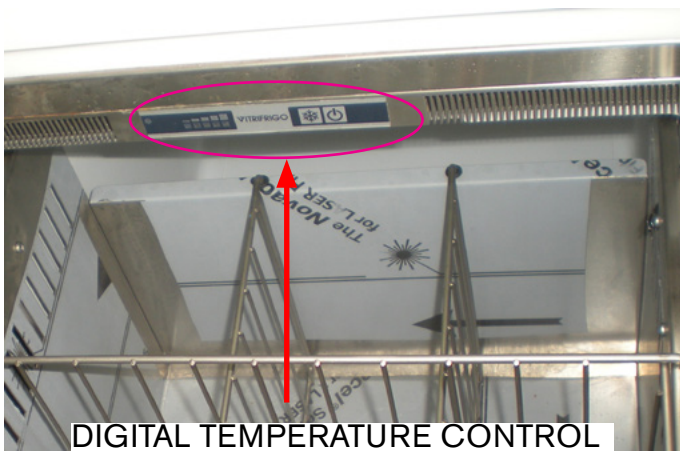

### Using Thermostat Control

*Note the thermostat (temperature control in the above illustration. This device digitally sets the refrigerator temperature and features 5 individual temperature levels.*

*Note the power “on” touch control on the right. The snow flake to the left is the power button on the refrigerator.*

*Note that an optional ice maker may be installed with the same type of digital bank control feature.*

## Usage Recommendations

- If possible, the refrigerator should be turned on for about 6 hours prior to filling food items.
- Frequent opening of the refrigerator door will result in greater consumption.
- Ensure that nothing blocks the refrigerator vent.
- Keep the inside of the refrigerator clean and dry.
- Keep the surface of the door clean and dry.
- The unit has been designed with a product lock protection in the event of low battery voltage. In the event of a compressor block, follow the instruction in the manufacturer’s owner’s manual or contact a marine technician.
- Note that the compressor can operate up to angles of 30 degrees; greater angles can cause damage to the compressor.
- Note that the unit contains refrigerant type 134 A. In the event of a loss of refrigerant contact a qualified certified technician.
- Periodically clean the condenser unit behind the refrigerator. Dust or vacuum the fan from any dust or lint debris.
- See the manufacturer’s owner’s manual for defrosting instructions.
- Consult the manufacturer’s owner’s manual for any troubleshooting information or contact your closest Regal dealer.

## Electronics

Various electronic components are available on the vessel including a cockpit hard top installed television, satellite KVH system, VHF radio, HD closed radar system, FLIR camera system and autopilot.

Each component utilizes individual operator's manuals. Refer to the appropriate electronic component operator's manual for detailed product information since the vast amount of information can not be covered here.

These manuals will cover features, operation, alarm and safety systems along with maintenance schedules. Limited component information and notes are found in this chapter.



## Fender Clips

The fender clip option features receivers integrated into the vessel hull side and quick release pins. The quick release pins attach to fenders with lines so they are ready to deploy as needed. When the vessel approaches a mooring the quick release pin with fender is attached to the receiver and pushed into place. This will help protect the boat from dock “rash” which could damage the rub rail or gel coat. When leaving the dock the pins feature a quick release mechanism which detach easily.



FENDER CLIP RECEIVER



FENDER CLIP RELEASE PIN



FENDER CLIP COMPLETE

## FLIR Camera System



If installed, the FLIR infrared camera system features the ability to pan objects ahead, to the side and tilt 90 through 110 degrees. The camera uses an automatic window along with 320 x 240 resolution thermal sensor and H264

encoded IP digital video stream. The camera is typically located on the hard top.

Basic operation uses thermal imaging (infrared) cameras to see clearly in low-light and no-light conditions. The camera is a network device that communicates over an Ethernet network (network extender/router located in the cabin under the headliner.

The camera is controlled with the video menu on either chartplotter. Read and understand the FLIR operator's manual before using the camera system.

Read all related safety labels.

Note that in cold weather climates the camera utilizes window heaters to de-ice the lens window.

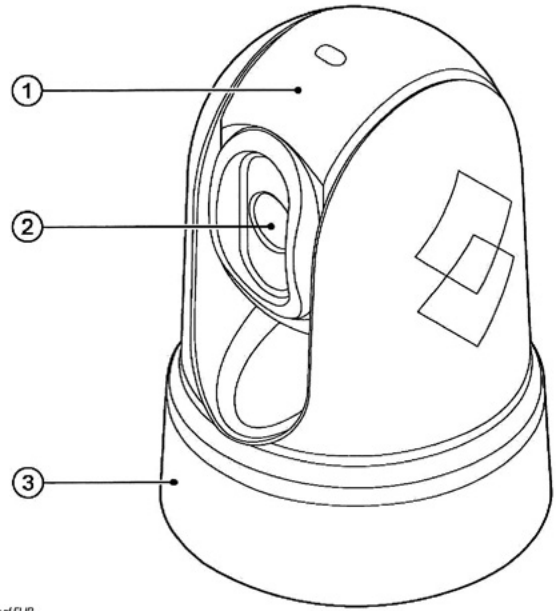

Courtesy of FLIR

1. Tilt assembly
2. Thermal camera lens window
3. Pan assembly



## Deck (Aft) UltraLounge Seat Operation

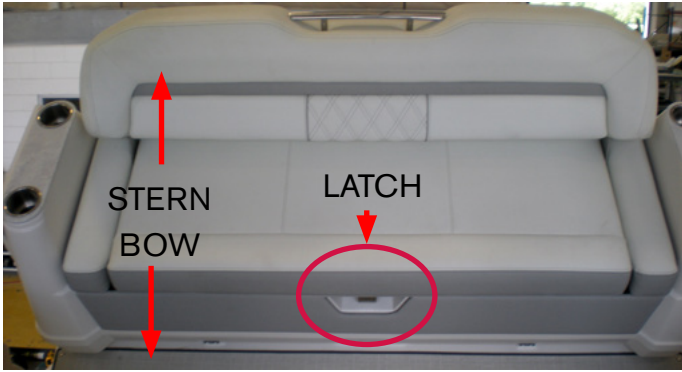

SUN LOUNGER IN FWD. FACING SEAT POSITION

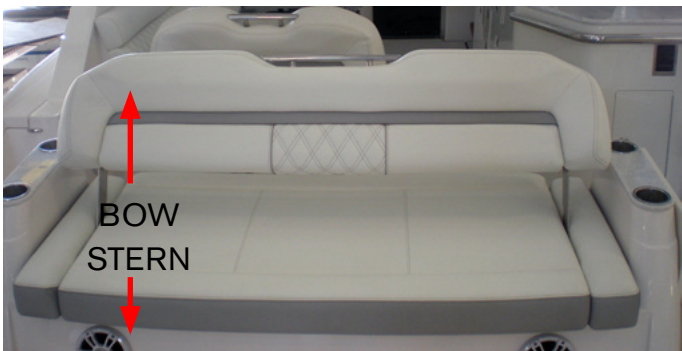

SUN LOUNGER IN AFT FACING SEAT POSITION



SUN LOUNGER IN FULL SUN LOUNGE POSITION

The aft UltraLounge seating is versatile with multi-function positions. It can be converted to a sun lounge position or to a bench seat style facing forward or aft.

1. By pulling on and holding the latch you will be able to push the seat back toward the stern for a forward facing bench seat position.

2. By pulling on and holding the latch you will be able to pull the seat back toward the bow for a rear facing bench seat position.

Once in the forward facing bench position pull on the latch again and work the seat down to a completely flat full sun lounge position.

*Note that it is recommended for passenger safety that the UltraLounge aft facing position is not to be occupied when the vessel is underway.*

## Deck (Aft) UltraLounge Seat Operation Con't.)



AFT SEAT STERN VIEW-MID POSITION SHOWN

The aft (UltraLounge) slide away seat features the ability to travel an estimated 12" aft from the full forward position for additional cockpit entertainment space.

This feature is only to be used only when the vessel engines (stern drives or outboards) are not in use.

To move the slide-away seat toward the stern press and hold the aft portion of the switch. The seat will move aft up to 12" depending on the original position.

To move the seat toward the bow press and hold the fwd. portion of the switch. The seat will move forward up to 12" depending on the original position. See photo at upper right.



Read and understand the label above.

For running purposes with passengers occupying the seat ***position the aft seat in the most forward position before making headway.*** This will assist the vessel to achieve an enhanced running position with persons weight distributed more proportionally.

Also, ***before opening the hatch*** to the bilge ensure the seat is in the most forward position.

*Note that when the aft seat is not in the most forward position the transom door will not latch tight.*

## Foredeck Seating Operation (Typical)



SUN LOUNGER POSITION

The foredeck features beverage holders, hand holds and a huge sun lounger that can be converted to a bench seat. To convert to seat pull forward on the center seat section. Lift up and engage the hinged seat back into the seat floor pocket.

Duplicate the above process to create a double wide foredeck seat.

To convert back to a sun lounger pull up on the hinged back and lift to clear the seat pocket. Move the hinged seat back aft of the seat pocket and let it slide into the sun lounger position.

It is not recommended to occupy the foredeck during periods of high waves and stormy conditions.



HINGED SEAT BACK & POCKET

	<b>WARNING</b>
AVOID DEATH OR SERIOUS INJURY FROM FALLING OVERBOARD! DO NOT OCCUPY THE SUN LOUNGE WHEN THE VESSEL IS MAKING HEADWAY.	



BENCH SEAT POSITION



## Helm Seat Operation (Typical)



The helm seat features a teak footrest at its front. Simply pull up on the stainless steel legs until fully extended and lower the footrest. See photo.

Helm seat technology integrates a seat riser for increased visibility and/or additional space at the helm. Just swivel the riser up to use.

Also, the helm seat can travel forward and/or backward by energizing the helm switch. The upper switch portion controls forward motion and the lower portion of the switch controls backward motion.

Note there is a rack behind the seat for magazines and for storing the stove and grill counter top covers.



## Mid-Berth Setup (Typical)

The mid cabin settee can be converted to a large sleeping berth. The fill cushions are located under the port side berth cushion. Under the port settee cushion are molded cut-outs.

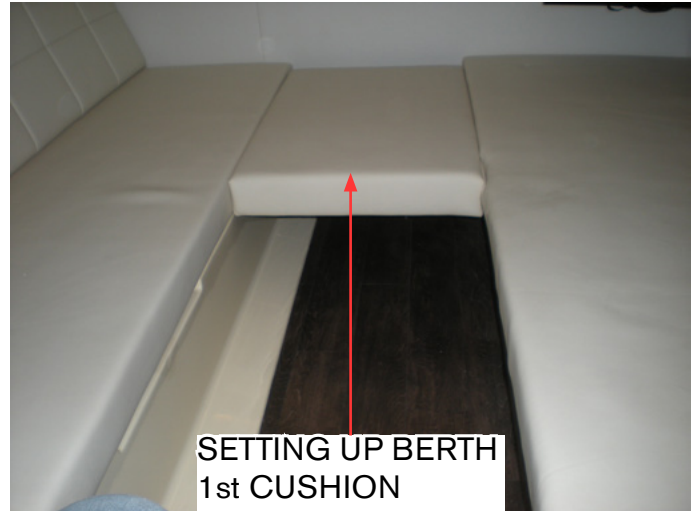

Remove the settee cushion to allow space to fill in each berth cushion with the support rail. As a filler cushion is added to form a berth the filler cushion support rail fits between the cut-out spacer and the cut-out inside radius for support. See the photo below.

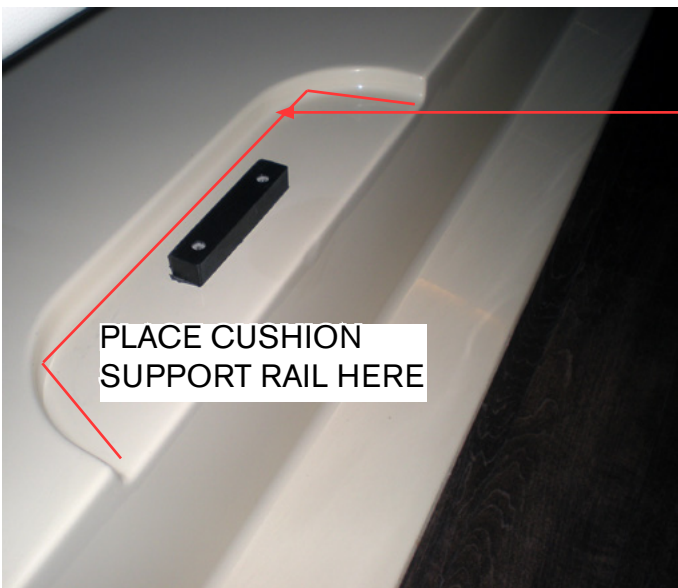

MID BERTH COMPLETE



## Radar-Garmin Radome HD Closed Array

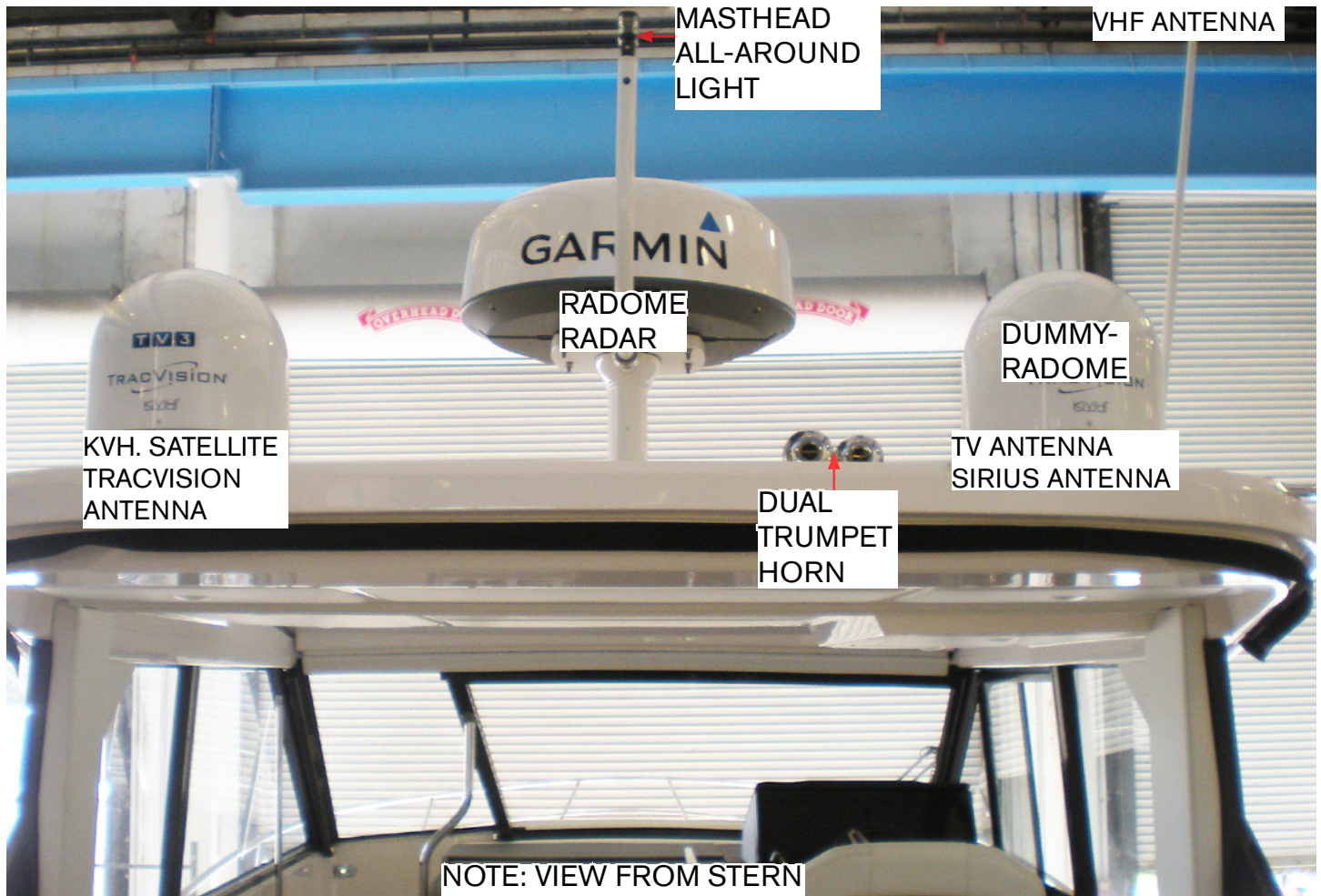

### Overview

As optional equipment a 4KW (4000 watts) high definition radar dome is installed on a hard top mast. The mast also serves as a masthead/anchor light. The unit features a dome with a maximum range of 48 miles. The radar is very customer friendly. The radar features a narrow beam width which provides a high resolution image. Dual range operation provides a fully independent split-screen display of far and close radar views in full 8-bit color. See chart plotter manual for additional features.

Read and understand the radar operator's manual along with all safety labels before attempting to use the component.

*Note that the standard "dummy" radome depending on boat options may house other electronic equipment inside such as KVH satellite TV.*

## Radar Continued

### Operation

To start up the radar do the following:

1. Ensure that the battery management panel is energized.
2. Depress the power button on the chart plotter to energize the plotter.
4. Choose radar menu on the home screen. You can make it a favorite.
5. Navigate to desired next menu buttons for more specific radar functions.
6. Note that radar over current protection is located at the breaker panel found on the bulkhead starboard side of helm seat.

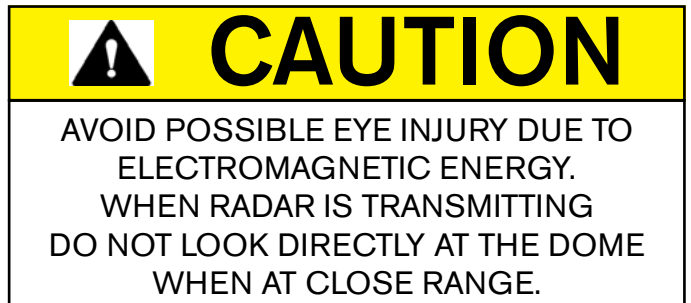
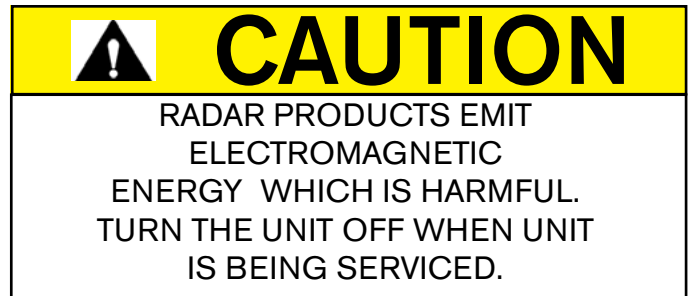

## SeaDek



As an option SeaDek® is featured on select vessel cockpit sole areas. The non-skid, closed cell material is derived from UV protected non-absorbent foam. You will find the product easy to clean with a high stain resistance.

Other features include noise reduction, great traction even when wet, body comfort when standing, walking or leaning on the swim platform.

To clean small dirt particles first try soap, hot water and a stiff brush. For surface dirt and footprints use glass cleaner and a clean rag.

If a more thorough cleaning is needed the manufacturer recommends you use bleach, 409, Simple Green, or Soft Scrub. Be sure to rinse thoroughly. Stay away from using any acid base cleaners.



## Seagrass Mat- Cockpit



If installed, cockpit sea grass mats feature urethane backing for marine environments. The mats provide style, comfort and durability as well as additional protection in environments where microbes are a concern.

Chilewich® products contain Microban®. This antimicrobial protection inhibits the growth of stain and odor-causing bacteria, mold and mildew for the product's life.

When storing your sea grass mats, always roll with the face of product out with the backing facing in. Do not fold or crease as the backing may split. Vacuum or hose off for regular cleaning. Dry face up or hang. Do not machine wash. Matting may be cleaned with a mild detergent and a sponge. Rinse with fresh water. Do not pull on material when removing from cockpit, but lift the snap instead to disengage it.



## Seakeeper

If installed, the Seakeeper uses gyroscopic principles to reduce boat motions in waves and wakes independent of boat speeds. A typical unit consists of a Gyro assembly, a CAN communications cable, and a helm display.

If installed, the Seakeeper is located under the aft cockpit of your vessel. The unit's cycling is controlled by an electronic controller and a hydraulic brake throughout each roll cycle as to supply maximum anti-roll torque and limits mechanical contact with the hard stops that limit the gimbal angle travel.

The Seakeeper operates from DC (direct current) and the unit is part of a dedicated 2 house battery system. There is a dedicated 100 amp breaker on the fire wall.

### Seakeeper Display

The display located on the port cabin wall is used to start, operate, monitor and shutdown the Seakeeper. Sensors, alarms, and shutdowns are provided to allow unattended operation. The display provides information in the event of an alarm. Select alarms can cause precession to stop and start the unit to coast down.



## TYPICAL SEAKEEPER



## WARNING

AVOID SERIOUS INJURY!  
DO NOT REMOVE THE COVERS FROM THE UNIT OR CONTACT ANY PARTS WHILE THE UNIT IS PRECESSING. MAINTENANCE SHOULD NOT BE DONE UNLESS THE SEAKEEPER IS LOCKED AND FLYWHEEL HAS STOPPED SPINNING.



## WARNING

AVOID SERIOUS INJURY!  
ENSURE ALL BODY PARTS & CLOTHING ARE KEPT CLEAR OF THE SEAKEEPER WHILE IT IS CYCLING.

After 12 volt DC power is present. the Seakeeper screen will energize and a home screen will appear. Here the ON/OFF touch screen button will appear grey (OFF). Once the button is pressed it will change to a blue color (ON).

When the menu button is pressed, a menu bar will appear or disappear at the screen bottom. The menu bar is used to navigate between pages. Refer to the Seakeeper operation manual for further information regarding the display, operation and understanding the alarm screens.

Also, specifications, troubleshooting, winterization, warranty, and periodic maintenance requirements are found in the operation manual.

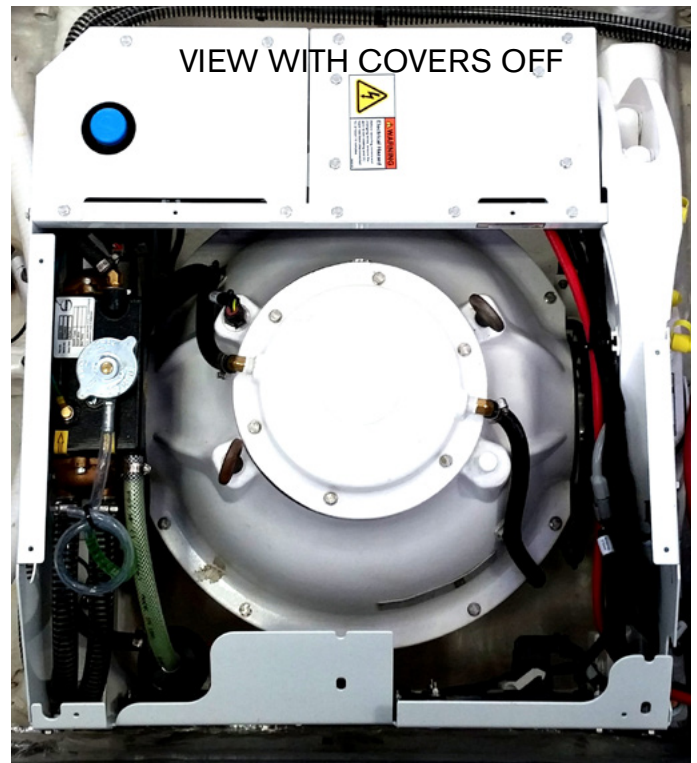

## Stereo/Entertainment



### Fusion Stereo

#### Introduction

Your Fusion stereo is part of the Apollo family which makes it simple to customize your audio entertainment and speakers for superior sound quality in any area of your vessel. A selection of Fusion technology features are found below. **Refer to your Fusion owner's manual for complete operating instructions.**

The Fusion stereo unit installed in your vessel is designed and engineered for the harsh marine environment. Head units are globally IPX5 rated against water ingress. When you leave your boat after a cruise weekend you can count on all selections being saved through a stereo memory system featured on your vessel, even with the main battery switch turned off.

Regal offers durable marine speakers and optional speaker LED lighting for ambiance.

The unit offers independent control of your audio entertainment including balance, sub woofer, and volume level from multiple audio zones as part of the optional stereo performance package.

The stereo features Fusion-Link™ an entertainment integration process which permits **Fusion to be displayed and controlled on your Garmin chart plotter using a NMEA 2000 network which communicates with each component.**

## Features

**Digital Sound Processing (DSP)-** A technically superior listening experience using precisely calculated loudness curves optimized for the human ear ensure quality, full range audio at every volume level with distortion controls in place.

**Party Bus\*-** A system of additional enabled stereos that gives you the option of joining Party Mode and play the same synced audio source through your entire vessel. You can go into Personal Mode and listen to available audio sources from your stereo in area of your choice without disrupting Party Mode in other sectors of the boat.

*\*Note that PartyBus and over the air software updates require the integration of an external network router or Apollo RA 770 stereo which may be available on line or from a Fusion dealer.*

**Over-The-Air Software Updates-** Available from your smartphone or compatible device through the free Fusion-Link app.





**More Source Options-** Bluetooth, UPnP, Optical Audio, advanced SiriusXM features and DAB + radio available, AM/FM radio, AUX and USB connections are readily available.



**Advanced SiriusXM features (USA Only):** Includes Instant Replay, TuneStart, TuneMix, SportFlash, along with Artist, Song and Game Alerts.

*Note that a SiriusXM subscription and tuner are required to access SiriusXM satellite radio (available in USA only) DAB + radio requires the addition of an MS-DAB100A module (sold separately).*



## Stereo/Entertainment (Con't)

Button	Function
Dial	<ul style="list-style-type: none"> <li>Turn to adjust the volume. <ul style="list-style-type: none"> <li>When adjusting the volume, press to switch between zones.</li> <li>When adjusting the volume, press and hold for at least one second to adjust the subwoofer levels.</li> </ul> </li> <li>Turn to move through the menus or adjust a setting.</li> <li>When in a menu, press to select the highlighted option.</li> <li>On a screen with tabs, press and hold for at least one second to open the other tab, such as the PARTYBUS tab.</li> </ul>
	<ul style="list-style-type: none"> <li>Press to turn on the stereo.</li> <li>Press to mute and un-mute the audio.</li> <li>Press and hold to turn off the stereo.</li> </ul>
	<ul style="list-style-type: none"> <li>Press to open the menu.</li> <li>Press to return to the previous screen from the menu.</li> <li>Press and hold to exit the menu.</li> </ul>
	<ul style="list-style-type: none"> <li>Press to change the source.</li> <li>Press and hold to open the PARTYBUS menu.</li> </ul>
	<ul style="list-style-type: none"> <li>Press to skip to the beginning of the track or to the previous track, when using an applicable source.</li> <li>Press and hold to rewind the track, when using an applicable source.</li> <li>AM, FM, or SiriusXM (in Live Mode) source: <ul style="list-style-type: none"> <li>Press to tune to the previous station or preset.</li> <li>Press and hold for faster tuning (manual mode only).</li> </ul> </li> <li>SiriusXM (in Replay Mode) source: <ul style="list-style-type: none"> <li>Press to skip to the previous track.</li> <li>Press and hold to rewind the current track.</li> </ul> </li> <li>DAB source: <ul style="list-style-type: none"> <li>Press to return to the previous DAB station in the ensemble. When you reach the beginning of the current ensemble, the stereo automatically changes to the last available station in the previous ensemble.</li> <li>Press and hold to change the ensemble.</li> </ul> </li> </ul>

	<ul style="list-style-type: none"> <li>Press to pause or resume media playback.</li> <li>AM/FM: <ul style="list-style-type: none"> <li>Press to cycle through the tuning modes (auto, manual, and presets).</li> <li>Press and hold to save the selected station as a preset.</li> </ul> </li> <li>SiriusXM source: <ul style="list-style-type: none"> <li>Press and hold to switch between Replay Mode and Live Mode.</li> <li>In Live Mode, press to cycle through the tuning modes (manual, category, and presets).</li> <li>In Replay Mode, press to pause and play.</li> </ul> </li> <li>DAB source: press to scan for DAB stations.</li> </ul>
	<ul style="list-style-type: none"> <li>Press to skip to the next track, when using an applicable source.</li> <li>Press and hold to fast-forward the track, when using an applicable source.</li> <li>AM, FM, or SiriusXM (in Live Mode) source: <ul style="list-style-type: none"> <li>Press to tune to the next station or preset.</li> <li>Press and hold for faster tuning (manual mode only).</li> </ul> </li> <li>SiriusXM (in Replay Mode) source: <ul style="list-style-type: none"> <li>Press to skip to the next track, if applicable.</li> <li>Press and hold to fast-forward the current track, if applicable.</li> </ul> </li> <li>DAB source: <ul style="list-style-type: none"> <li>Press to advance to the next DAB station in the ensemble. When you reach the end of the current ensemble, the stereo automatically changes to the first available station in the next ensemble.</li> <li>Press and hold to change the ensemble.</li> </ul> </li> </ul>

### Stereo Screen

The information displayed on the screen varies depending on the source selected. This example shows the device playing a track on a device connected using Bluetooth® wireless technology.



①	Source
②	Network status ( <i>Network Status Icons</i> , page 11)
③	Album art (if available from a compatible source)
④	Track details
⑤	Elapsed time, track duration, and the current track number out of the total number of tracks in the playlist (if available)

### Selecting a Source

- 1 Select .
- 2 Turn the dial to highlight a source.
- 3 Press the dial to select the source.

**NOTE:** Some sources appear in the source selection screen when they are not connected to the stereo. The USB icon is red when a USB device or cable is not connected.

Activate the Garmin plotter screen to control the stereo display functions and features. In addition the system can be controlled by activating the Apollo unit at the passenger side of the cockpit.

More product information along with operation manuals can be downloaded at the following web address:

[www.fusionentertainment.com/marine](http://www.fusionentertainment.com/marine)

See the troubleshooting chapter for system assistance or contact Fusion web-site.



## Stereo/Entertainment NMEA 2000 Network

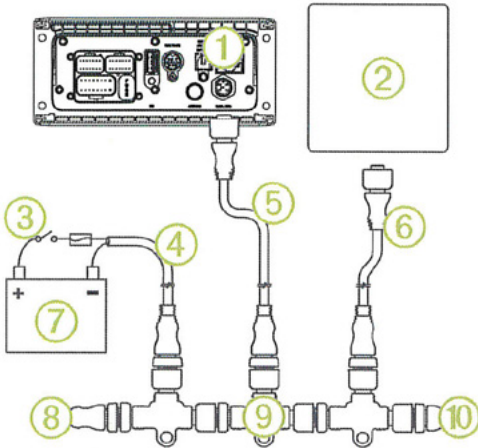

①	Stereo
②	Supported chartplotter MFD or compatible FUSION NMEA 2000 remote control
③	In-line switch
④	NMEA 2000 power cable
⑤	NMEA 2000 drop cable from the stereo, up to 6 m (20 ft.)
⑥	NMEA 2000 drop cable from the chartplotter MFD or compatible FUSION NMEA 2000 remote control
⑦	9 to 16 Vdc power supply
⑧	NMEA 2000 terminator or backbone cable
⑨	NMEA 2000 T-connector
⑩	NMEA 2000 terminator or backbone cable

Above is a typical NMEA 2000 network as used with the Apollo Fusion series entertainment package. Note the backbone to which all individual components including the Garmin plotter are connected to for communication purposes. The system uses 12 DC power and is protected by a fuse located under the dash inside the yellow sleeve connector. Note the terminator plugs on each end of the backbone. They must be intact for the backbone to operate efficiently.

Should the system stop working check the fuse, all backbone connections and the terminators for missing caps.

Note that a majority of the backbone can be accessed behind the Garmin starboard helm display. Also, check for proper system DC grounding. Ensure that system voltage is at 9 or higher as low battery voltage will effect NMEA 2000 operation.

## Sirius XM Satellite Stereo

With the optional satellite antenna installed and an activated subscription you will be able to program and preset Sirius XM audio stations through the “glass cockpit” chart plotter.

Before the subscription can be activated you must have the radio ID on the rear of the Sirius XM tuner. For more information, call 1-866-635-2349 domestically.

## Stove- Cooktop

### Overview

The electric stove (cooktop) on your vessel will afford you years of service. Read and understand the information here and in your cooktop owner's manual. Pay close attention to all safety instructions. The cook top features 120 volts of AC electricity for carefree cooking similar to a home unit.

Note that prior to activating the stove control the stove cover must be inserted in the aft set of slots. As circled below there is a switch that controls power to the stove. **Only when the cooktop cover is properly aligned in the assigned slots will the control panel be able to be activated.**

The stove will not operate without the cover in the correct slots. See the photo below and to the right to assist placing the stove cover in the aft slots.



COCKPIT SINGLE BURNER COOKTOP

Note in the photo below that the scallops are facing up on both the cooktop and grill cover.

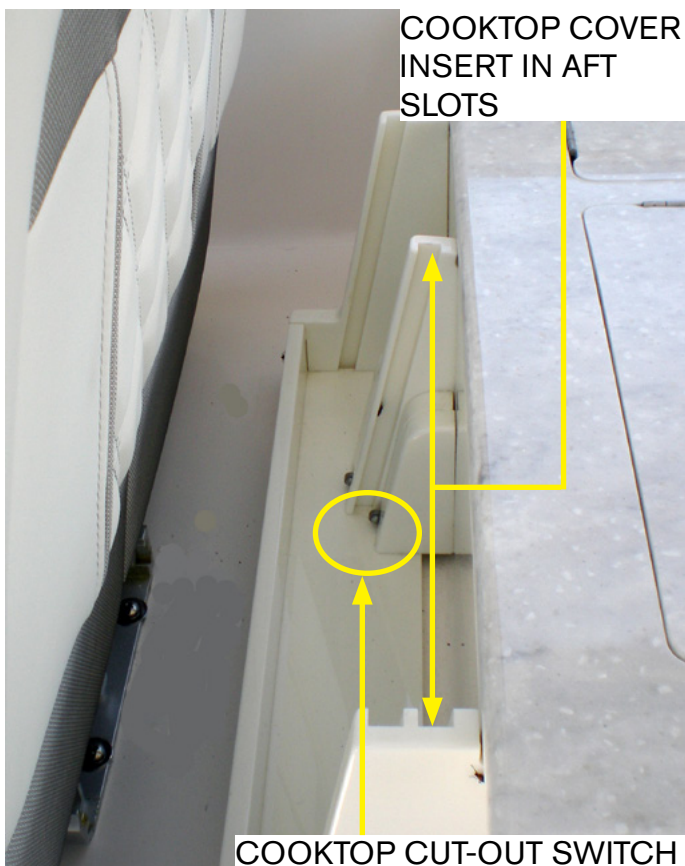

COOKTOP COVERS IN PROPER SLOTS FOR ACTIVATING CONTROL PANELS

## Cook Top Operation

**If this is the first time use make sure the plastic film covering the cooktop has been removed and the recommended cleaner is used to coat the surface. Refer to cooktop manual.**

As a quick start for the stove do the following and refer to the cooktop owner's manual as needed for further information.

1. Energize the stove (cooktop) breaker at the ship's main AC panel.
2. Remove the cover from the cooktop and insert it into the aft slots in the rack behind the helm seat. Make sure it is inserted completely in the slots. Power is now available at the cook top master control at the burner.

*Note to refer to the following pages for basic cook top start up information or review the cook top owner's manual in the owner's information packet.*



# Touch Controls

## Power ON Indicator

This display indicates whether the grill is ON or OFF

## Power Level Display

Digital display indicates heat output of the selected element. The indicator lamps follow the sweep of the screened graphic. There are eight possible heat levels.

## (+) Power Sensor

Touching this sensor will increase the heat output of the selected element in increments of one.

## (-) Power Sensor

Touching this sensor will decrease the heat output of the selected element in increments of one.

## Power Level Graphic

Depicts the level of heat output by the element. The line sweeps from thin to thick, indicating low to high power.

## Master Power Sensor

This is the main power control for the selected element. Touching this with the element OFF will activate the controller and turn the element ON. Touching this sensor with the element on will shut the element OFF.

## Calibration

Upon application of electrical power to the cooktop, the controller will run a self-calibration process. The controller will then sound an audible confirmation tone and the display will briefly illuminate. The cooktop is now ready to be used.

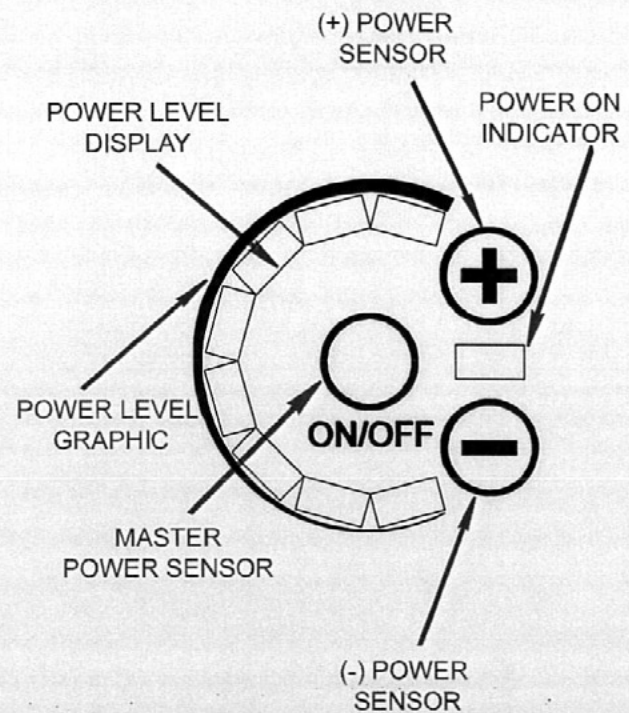

CONTROL GRAPHICS



## IMPORTANT!

The glass panel must be clean prior to powering on to ensure proper calibration.

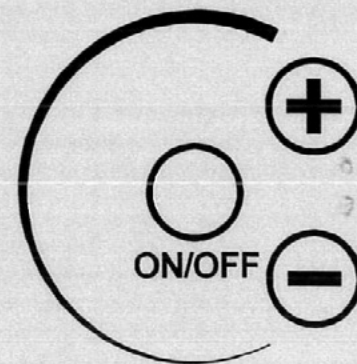

Courtesy Of Kenyon



### Energizing the Elements

To turn the selected element ON, touch and hold the Master Power Sensor for two seconds. The controller will then beep and the Power On Indicator will illuminate.

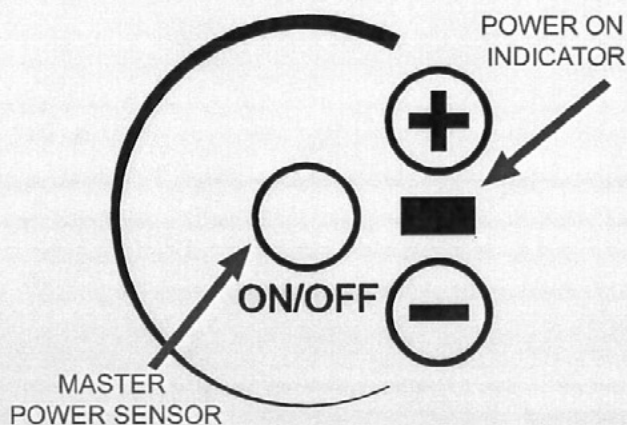

### Heat Settings

Your KENYON cooktop has 8 different heat settings, from 1 through 8, selected using the (-) and (+) sensors. The heat setting is displayed as shown below. The heating element cycles at different time intervals to vary the heat level. As the setting is increased, the heating element will remain on for a longer period, increasing the cooking temperature of the grill.

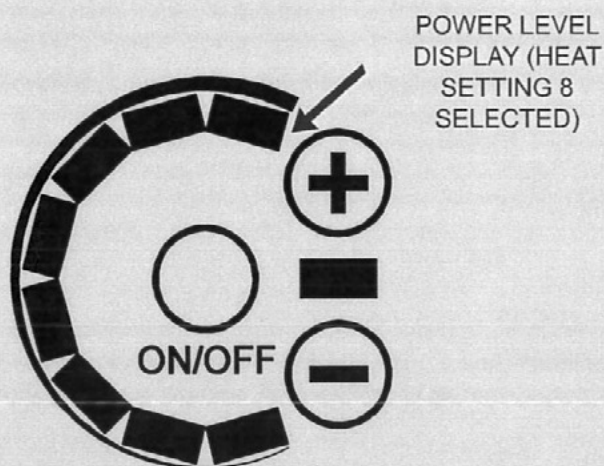

### Automatic Shut-Off

The cooktop is programmed to automatically shut-off if it is left unattended for an extended period of time. If left on high (8), it will switch off after one hour if no control changes are made. This time period is dependant upon the power level. The lower the power level, the longer the time period (maximum time is 2 hours).

The control will also power off after ten seconds if a heat setting is not selected upon initially applying power to the cooktop. The table below provides the auto shut-off time for each power setting.

SETTING	AUTO SHUT-OFF (min)
1	90
2	90
3	90
4	60
5	60
6	60
7	60
8	60

### Temperature Setting Guide

SETTING	USES
1 Bar	Melting butter and chocolate Heating delicate sauces Warming food
2 Bars	Simmering sauces Steaming rice Melting large quantities
3-5 Bars	Steaming vegetables Heating soups, pudding and milk Simmering Frying
5-7 Bars	Sauteing Quick frying Browning Boiling of large quantities
8 Bars	Boiling water Deep frying

## Sunroof



Your vessel features a retractable sunroof to catch some sun rays and to provide further cross ventilation. When closed the sunroof design of smoked acrylic protects from the direct rays of the sun but yet is translucent permitting constant sunlight. To operate utilize the helm switch for the desired opening. Be sure to close the sunroof when leaving the vessel for an extended period.



## WARNING

AVOID SERIOUS INJURY!  
KEEP ALL BODY PARTS  
CLEAR OF SUNROOF COMPONENTS  
WHILE THE DEVICE  
IS EITHER OPENING OR CLOSING.



## Sunshade System (Typical)



REFERENCE VESSEL SHOWN

Optional manual bow and cockpit sunshades may be installed on your vessel. The foredeck shade is referred to as a Bahama shade. The shades feature fiberglass poles, easy to use fastening system and durable Sunbrella canvas material.

*Note that instructions for use are found on the poles themselves.*

*Note that although a different model the photo above displays the bow Bahama shade system.*

*Other options include an aft canvas system without isinglass called a palm beach enclosure . Also, there is an cockpit enclosure with isinglass. Furthermore, as an option a Macralon salon enclosure system is available.*

## Bahama (Foredeck) System Safety Tips/Notes

1. Do not use the sunshade system while making headway.
2. Do not pull the pole out further than the length shown.
3. Do not use the sunshade system when it rains.
4. The finish on the sunshade poles is carbon fiber which can conduct electricity. Caution must be used around power and lightning.
5. Always store poles in their designated enclosure
6. Roll sunshade verses folding it.
7. Periodically clean sunshade and rinse until dry.
8. Prolonged exposure to sunlight may result in discoloration of poles.
9. Make sure the pole sockets installed in the deck are free of water which will promote rusting.

Read and understand the warning label and drawing adhered to the poles. There is a QR code on the pole label which can be scanned with your phone for the pole owner's manual.

## Table (Typical)

The teak table is located under a cockpit seat. The table features teak a hardwood known for beauty and durability. There is a pedestal base on the bottom of the table to insert the table leg.



A



PATIO TABLE SET UP



COCKPIT TABLE SET UP

## Setting Up Table

1. Remove the table from the locker.
2. Find the table leg.
3. Insert the leg into the table pedestal.
4. Lift the table and leg assembly up and insert into the receiver. Wiggle the sides of the table as needed force the table leg completely down inside the receiver.
5. To disassemble table reverse the process.

*Note that it is recommended that the table assembly be stored before making a major cruise into rougher seas or other adverse weather conditions.*

### TABLE RECEIVER



*There are table receivers in various locations depending on the vessel model.*



## Television/Entertainment



COCKPIT TELEVISION OPTION

### KVH Satellite Television: Use Following Instructions- At Sea Operation

1. Activate the entertainment breaker at the ship's main AC panel located in the cabin.
2. Activate the entertainment breaker on the DC panel located in the cabin as a portion of KVH system is 12 volts.
3. Activate the ship's antenna at the DC distribution panel.
4. Push the ship's antenna button (B). This will power up the special antenna to receive satellite signals.
5. Power up the satellite receiver. Refer to the KVH owner's manual for further information.

One feature of the cockpit television is that with the plotter energized to a particular screen the skipper can display that screen at the television. Just choose HDMI 1 or HDMI 2 on the cockpit television remote.

All television coaxial splitters and the booster for the television mushroom antenna are behind the main ship's AC panel. **With the shore power disconnected at the vessel inlet** access can be found by removing the panel's phillips head screws.

*Note there is an optional television available for the mid cabin (berth).*

Refer to the television system overview drawing on the next page for furthermore.

*Note that components, specifications, and circuit wiring can change at any time.*

## Television/Entertainment-Continued

If installed the mid-berth television requires 120 volts AC. The entertainment breaker on the AC portion of the ship's master cabin panel controls the mid-berth television. Therefore, it must be on to view the mid berth television. Follow the same procedure as the cockpit television.

### Television Antenna Switch

The television antenna switch (sometimes called the A-B switch) is located above the monitor panel in the cabin close to the ship's main AC panel. The purpose of the antenna switch is two-fold:

**At sea-** Press the ships antenna or B button. This permits the mushroom television antenna installed on the hard top to find possible TV stations through the use of the antenna and its booster. *Note that in some circumstances you may not be able to receive any type of signal.*

**At shore-** Press the shore button (A). Now you are using a land signal brought through your coaxial cable.



MID BERTH TELEVISION OPTION



HDMI PLUGS

Note for further system information regarding the TV antenna wiring or HDMI's and related component wiring refer to the drawing on the previous page.

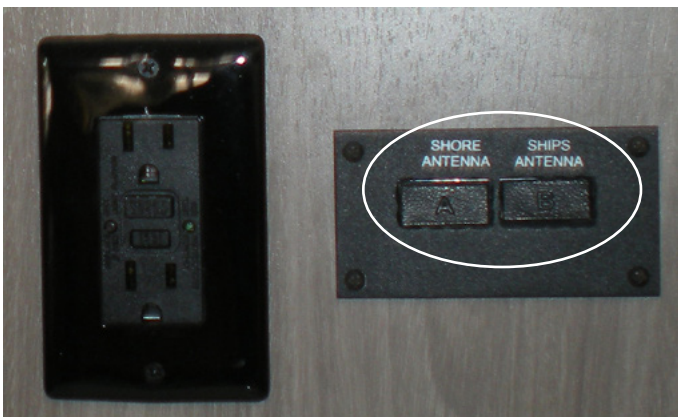

## Satellite Television (KVH TracVision 3)

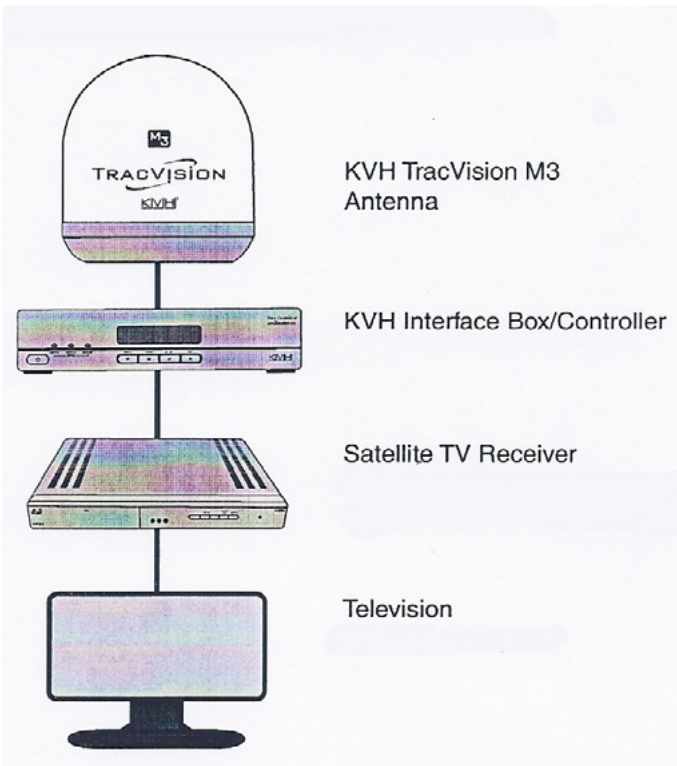

### Overview

The optional KVH TV3 Series uses a 14.5" antenna which extends service to cruising areas located within 100 nautical miles offshore in North America.

Under the starboard "dummy" dome is the TV saucer-shaped antenna.

The KVH satellite breaker is controlled by the entertainment breaker at the ship's main AC panel.

## Satellite Television Components

If installed, the satellite television option typically features the ability to viewing hundreds of television channels using the vessel 120 volt HD televisions. Basically, the signal is transmitted through an antenna system installed on the hardtop which features a satellite tracking system that automatically finds the satellite for crystal-clear television reception. **To activate satellite television a subscription must be secured. For more information call 1-800-970-9623. Read notice below.**

# NOTICE

SATELLITE TELEVISION REQUIRES SUBSCRIPTION TO OPERATE. CALL 1-800-970-9623 TO INITIATE SUBSCRIPTION. ONCE ENROLLED THE CORRECT REGIONAL RECEIVER WILL BE ISSUED TO YOU.

### System Components-Antenna

The antenna uses modern technology to quickly acquire and track the correct satellite, switch between satellites, and send signals to the interface box. Internal gyros allow the antenna to track the satellite at all times, even with the vessel on the move!

### Interface Box-Controller

The interface box supplies power to the antenna system and delivers satellite TV signals to the satellite receiver. This component is also used to set-up the LCD display.

## Satellite Television Receiver

The Dish network receiver has been chosen because of its compatibility with the KVH components and is region-specific. This unit receives HD (high definition) signals from 3 DISH network satellites including DIRECTV, DISH network and Bell TV in North America.



The satellite receiver shown is located in the mid berth attached to the inside of the starboard top shelf accessed through the removable panels on either side of television.



Television/Entertainment -HDMI (Typical)

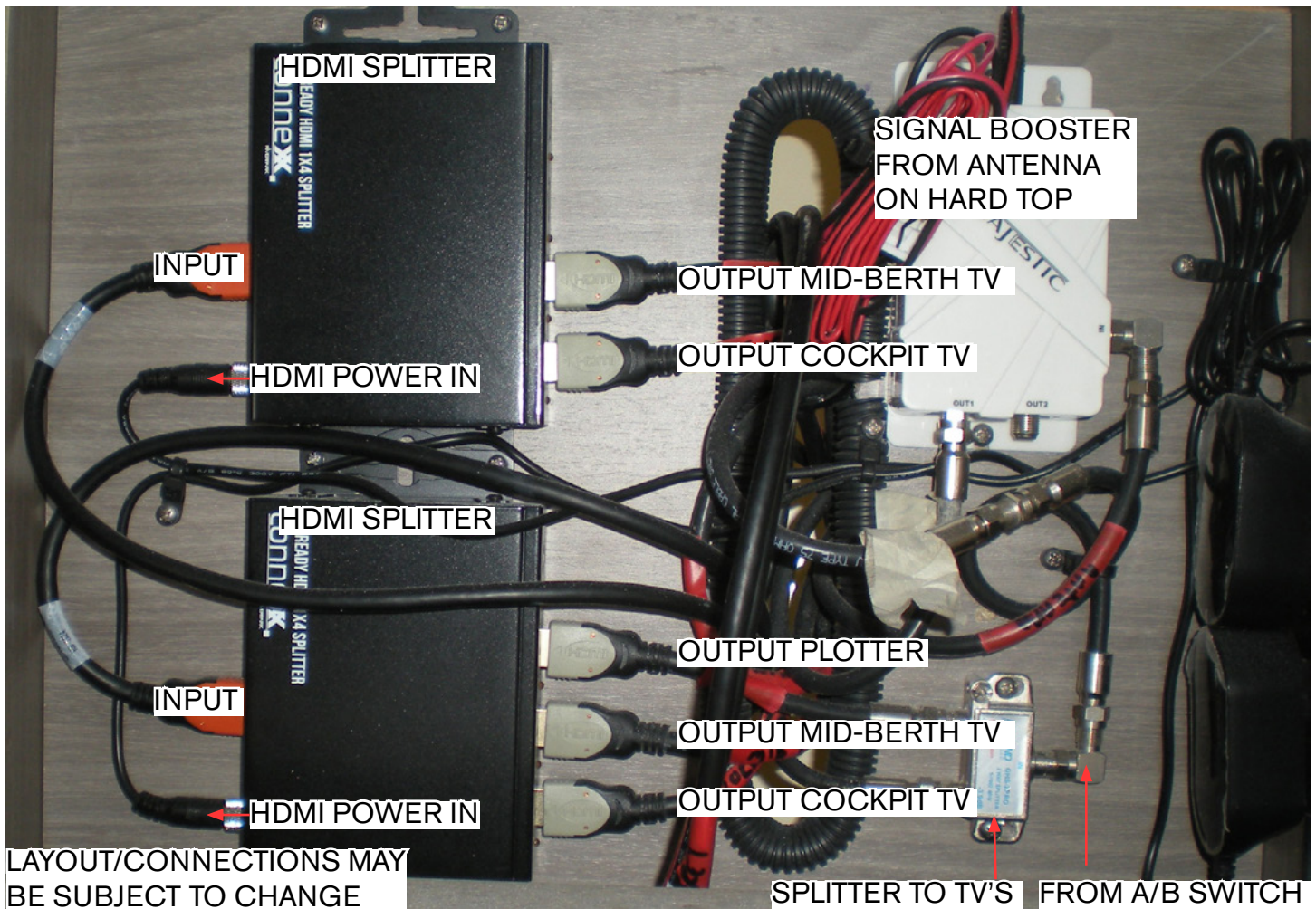

Photo above shows typical electronic components shown on previous page inside forward starboard cabinet access in the mid berth.

To access components remove the forward upholstered cover.



# TV SYSTEM COMPONENTS/WIRING

Subject Work Instruction: VJ/VK TV System	Issue Date: 04/24/2020	Rev: 0	Document No. EL-114
Approved By: Dion Colbourne	Written By: Kyle Quatman	Rev Date: ----	Page: 1 of 1

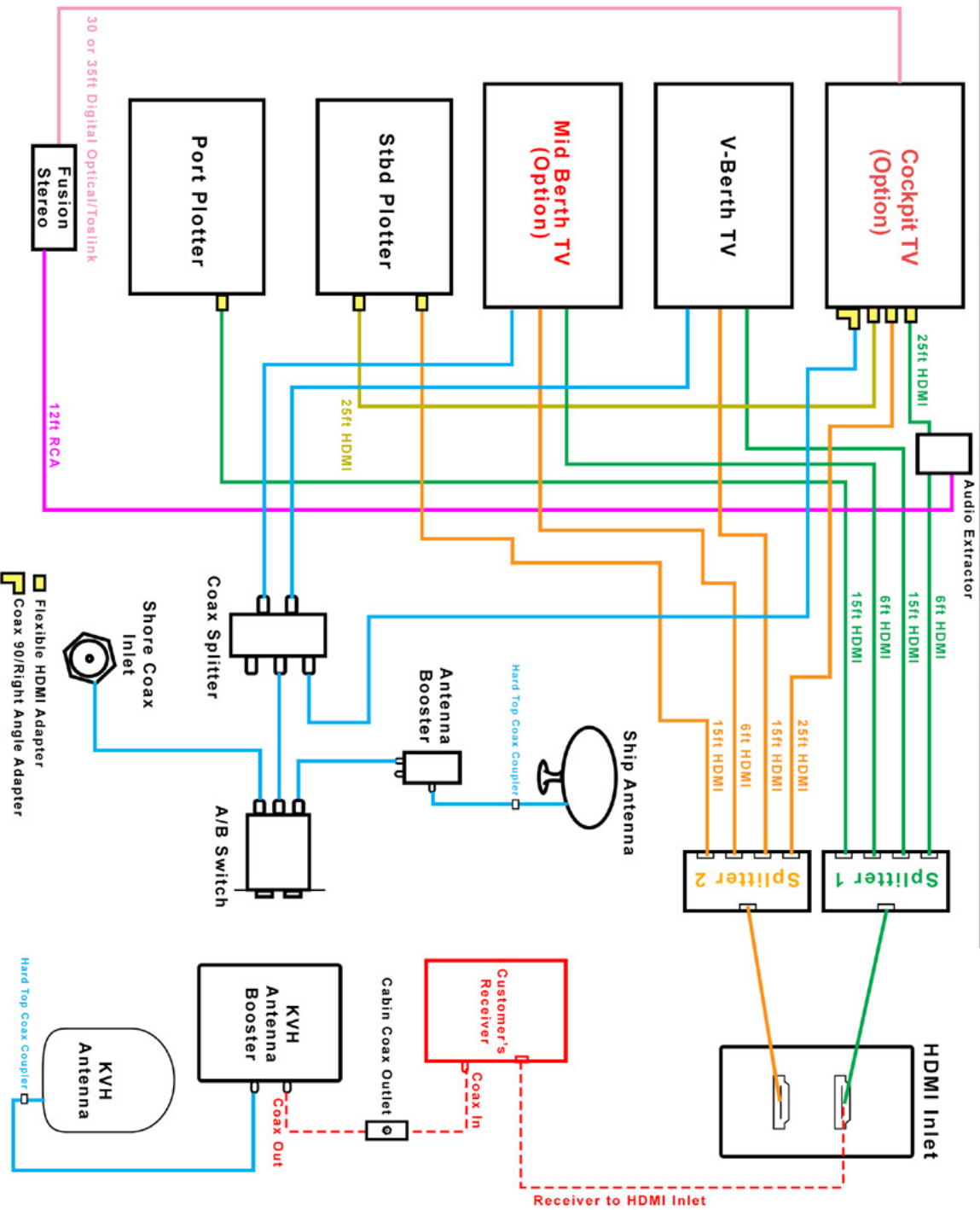

# TV SYSTEM HARNESS ROUTINGS COAX NETWORK

Subject Work Instruction: V/J/K Coax Network	Issue Date: 03/10/2020	Rev: 0	Document No. EL-125
Approved By: Dion Colbourne	Written By: Kyle Quatman	Rev Date: ....	Page: 1 of 1

*[ REFERENCE ONLY ]*

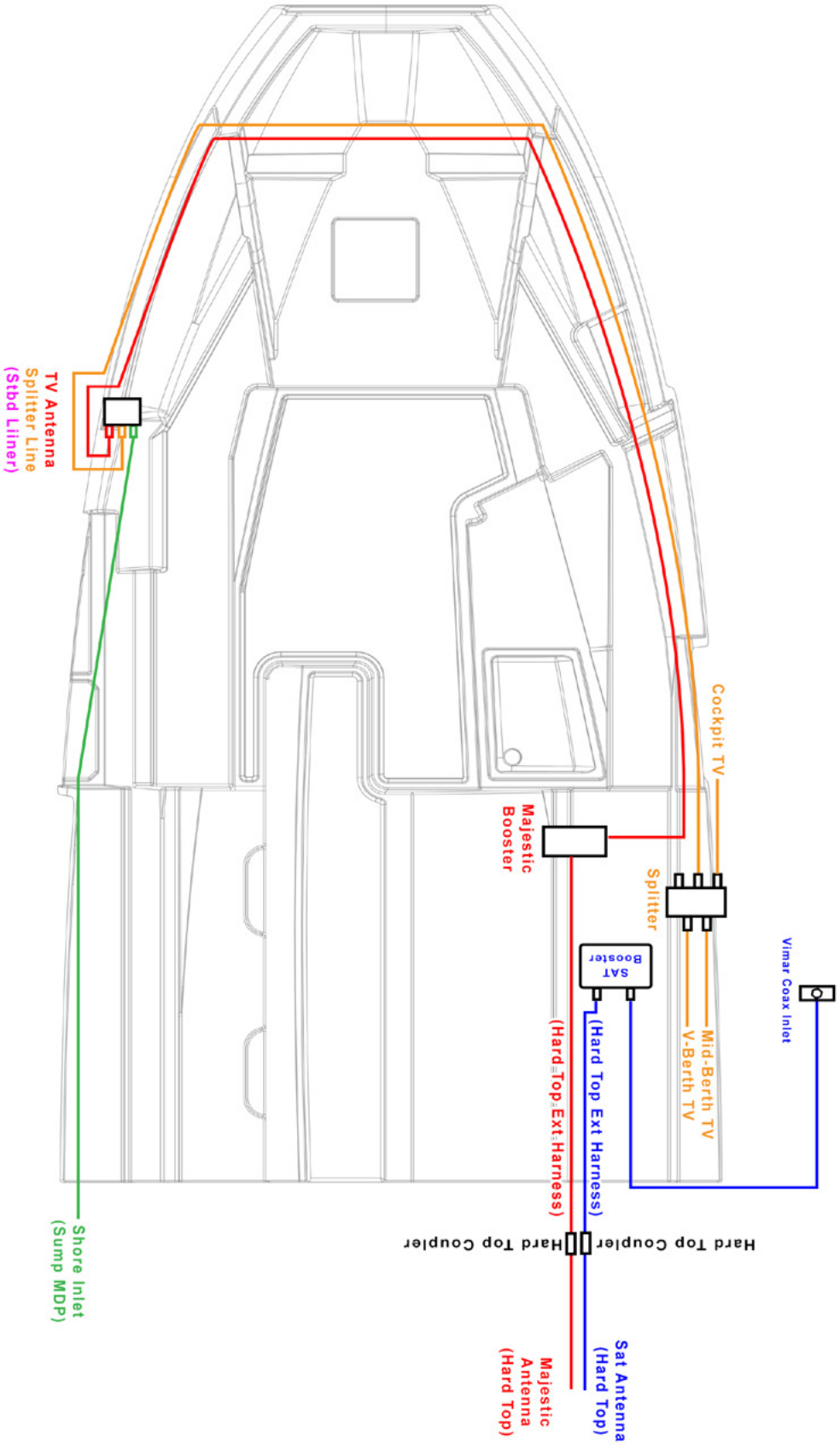

## Transom Door (Typical)

The transom door provides access to the swim platform and may be useful in certain mooring situations by providing easier access while disembarking.



To open the transom door use the latch mechanism and open until the magnet on the seat engages the door frame.

To close the transom door pull shut and ensure it is latched.



Read and understand the following label.

For the safety of all passengers ensure that the transom door is closed and latched when engines are running.

**Remember to position the slide-away aft seat completely forward to latch correctly.**



## Trim Tabs (Typical- Stern Drive/Outboard

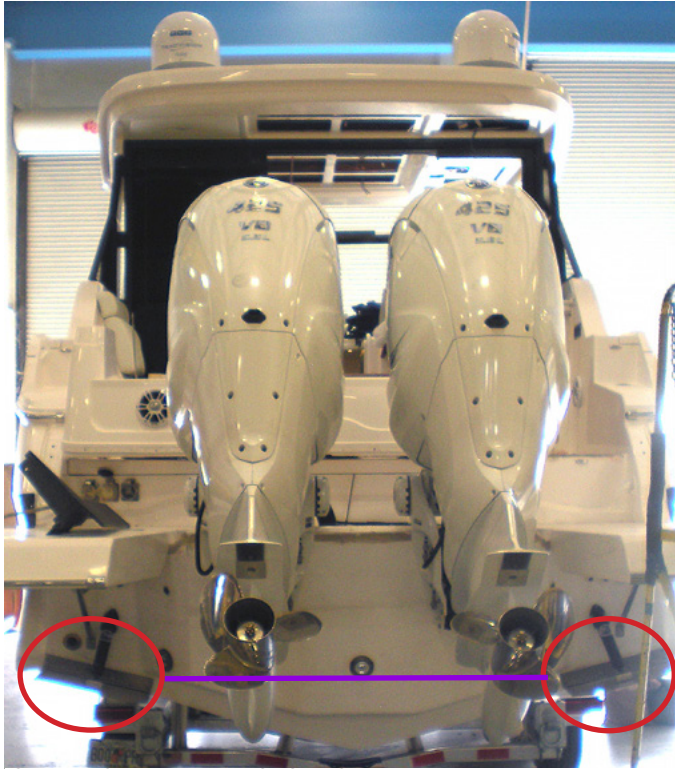

OUTBOARD TABS SHOWN HERE

Trim tabs are located on the lower hull of the transom. Water is deflected and redirected as the trim tabs are raised and lowered from the starboard helm located trim tab switch. This change in water flow creates upper pressure under the tabs, and raises the stern. When the stern rises the bow is lowered. Lowering the port tab will cause the port stern to rise, making the starboard bow lower. Lowering the starboard tab will cause the starboard stern to rise, making the port bow lower. The pressure originates from a pump and valve system at the aft bilge. When used with the engine power trim a fine tuned ride can be achieved. The trim tabs will compensate for uneven weight distribution, listing, water conditions, and other factors that cause inefficient operation. Remember, that trim tabs are trimming the hull while power trim is trimming the drives.

## Obtaining A Trimmed Position

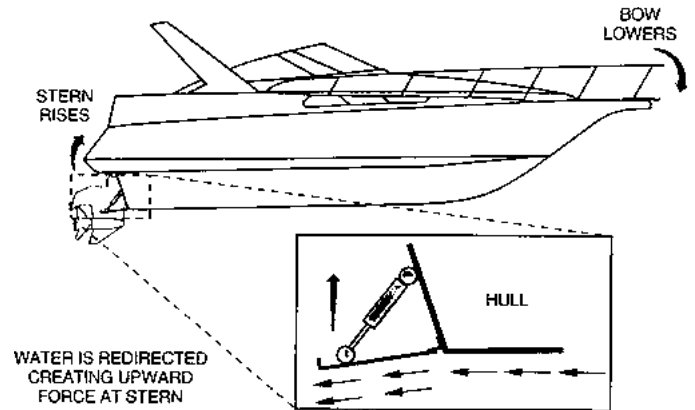

Your vessel will reach a planing position at a specific speed. This speed is determined by bottom design, weight distribution, water conditions, and on board equipment. As the throttle is advanced the stern squats and the bow rises initially. The trim tabs allow your boat to plane at a slower speed than natural conditions allow. *Note a stern drive example above.* In short bursts both trim tab rocker switches are pushed simultaneously in the “bow down” position which causes the trim tabs to move down. As the boat breaks over the bow high attitude the boat speed accelerates and visibility increases.

If the boat is over-trimmed, it will plow the bow and the boat will lose maneuverability. If this occurs, simply short burst the “bow up” trim tab rocker switches simultaneously.

In the “learning curve” process, press the tab switches in half second bursts. You will notice a slight delay from the time the switches are pushed until the boat reacts depending on vessel speed. You will know after awhile the optimum planing angle and speed and will be able to set trim by using the indicator lights on the outside of the display panel.

When running in heavy seas press the “bow down” position which will assist the vessel to cut through the waves. This will produce a drier and more comfortable ride. In a following sea run the tabs in a fully retracted angle for maximum drive response. Sometimes you can watch the bow spray or stern wake and the rooster tail (mound of water produced by outboards). In a bow up position the spray is far aft to the hull, the wake is high and the rooster tail is high.

When trimmed or in the bow down position, the bow spray is farther forward, the wake and rooster tail are smaller, and positioned further behind the vessel. Also, when trimmed you will notice that tachometers show an increase in rpm’s.

#### Rectifying A List

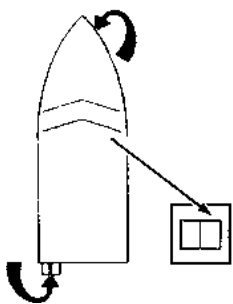

Your vessel can use the trim tabs to rectify a list. The trim tabs adjust the boat’s attitude in the direction the helm rocker switch is pushed.

If the port bow is high, push the left-hand “bow down” direction on the dash rocker and the port bow will lower. If the starboard bow is high, push the right-hand “bow down” direction and the starboard bow is lowered.

#### Using Power Trim With Trim Tabs

##### TRIM TABS WITH POWER TRIM

- Trim Tabs Trim Hull
- Power Trim Trims Prop

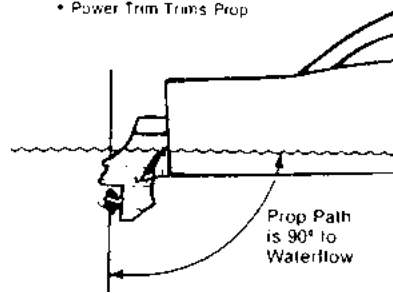

Adjust the trim tabs to achieve a planing attitude. Use the power trim to position the prop path parallel to the water flow. At this point the trim tabs

may need a fine adjustment.

One advantage of the trim tab system is that they allow trimming of the hull while the power trim results in trimming the props.

*Note that Illustration above displays stern drive units.*



The indicator lights display the relative position of both port and starboard tabs at all times.

## Underwater Lights

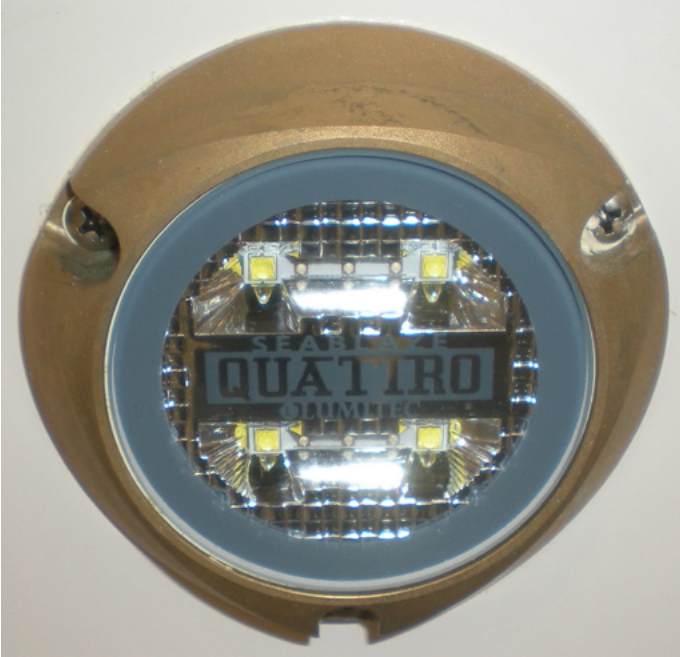

Dome shaped blue LED clusters make up the underwater lighting system. The lights are located on the transom along with the port and starboard hull sides. There is a dash switch for energizing the lights and a breaker under the dash to protect the system.

## Vacuum Cleaner System- Central

The vacuum system is located in the forward state-room at the starboard wall of the berth. Included is a netted bag of hoses and various vacuum attachments normally stored under the forward berth.

### Safety Warnings

1. This is a dry vacuum system. Do not use on wet surfaces.
2. Never operate the vacuum without filters and bags in place.
3. Use careful monitoring when children are around. Do not let the vacuum cleaner be used as a toy.
4. Do not try to repair the vacuum as the unit is sealed. Return the unit to InterVac or an authorized repair center for proper repairs.
5. Use only as described in this manual. Use only factory attachments and bags.
6. Do not use with any blocked openings. When the secondary filter becomes dirty, rinse in warm water or replace the filter. Filters must be completely dry before using.
7. Never drop or put any object into any opening.
8. Turn off the accessory breaker at the ship's AC panel to deactivate the vacuum cleaner.
9. Keep all body parts and clothing away from any moving parts.

10. Do not pick up anything that is burning or smoking such as cigarettes, matches, hot ashes or sharp objects. Do not use without dust bag or filters in place.

11. Do not attempt to operate the unit with a wet hose.

12. Do not store objects close to the vacuum unit.

13. Do not pick up flammable or combustible liquids such as gasoline, or use in areas where they might be present such as the bilge.

14. Do not step on the hose, nozzles or pull hard on the hose.

### Operation

1. To operate the vacuum energize the appropriate accessory breaker at the main ship's main AC panel.

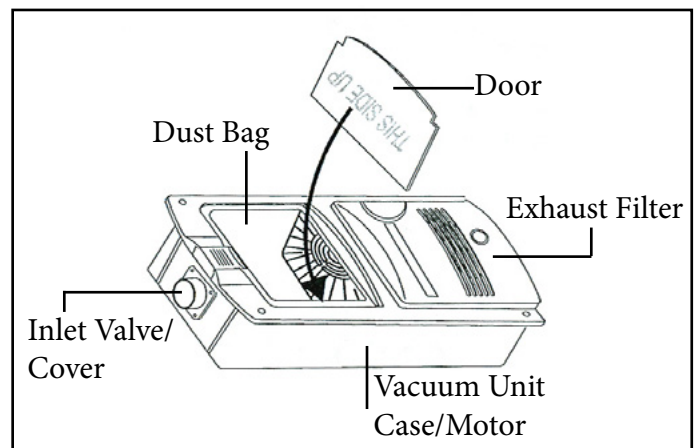

2. Lift the inlet cover on the vacuum unit.

3. Insert the hose cuff (one with the metal band) with a slight twist and the vacuum cleaner should start.

4. To remove, turn hose in either direction while pulling the hose toward you and the vacuum cleaner will stop.



## Vacuum Cleaner System- Central Continued



INSERT HOSE CUFF HERE

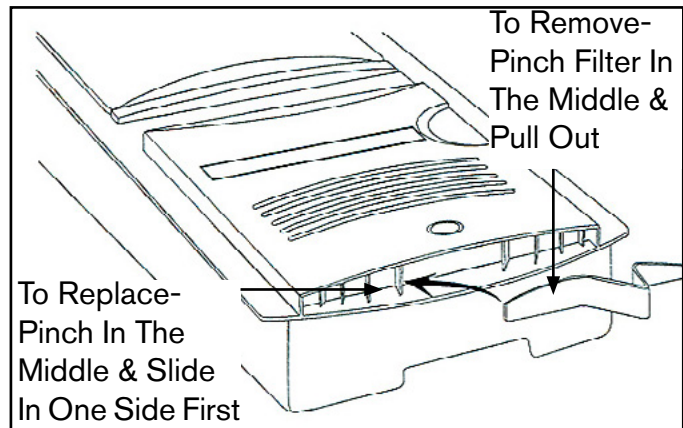

REPLACING EXHAUST FILTER

## If The Motor Stops Suddenly:

1. The most common cause is a clogged hose. Try to unclog the hose with a long object or by shaking the hose until the debris falls out.
2. The bag is overfilled and fine dust has clogged the bag.
3. The vacuum cleaning tools are clogged.
4. The motor (exhaust) filter is dirty and should be cleaned or replaced.
5. While the vacuum cleaner is being used keep the berth open to provide additional air to the unit. This will help the unit from shutting down.

*Note if the motor stops the thermal protector on the unit will reset automatically after about 1/2 hour. This is normal for the vacuum cleaner.*

## Windshield Wiper

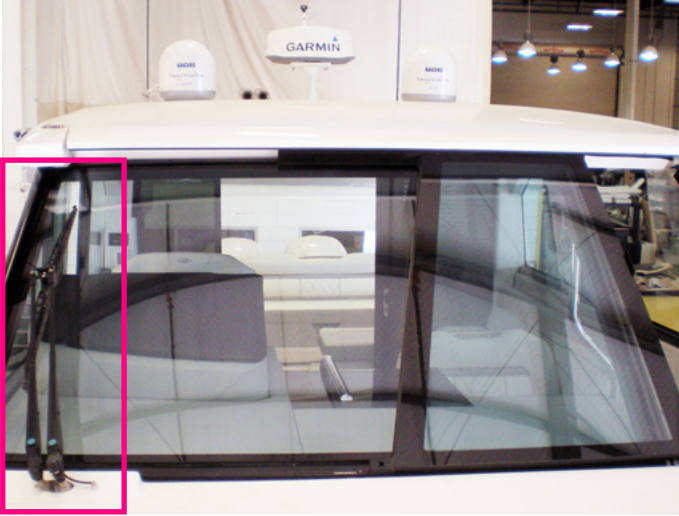

The windshield wiper installed on your vessel features a planographic design which keeps constant pressure on the wiper blade to ensure a more efficient removal of water on each sweep.

The wiper switch features continuous low and high speed positions including 6 intermittent delay intervals ranging from 3-18 seconds. Also, the switch incorporates an LED night light indicator.

*Note that windshield damage may result if the wiper blade is run over a dry windshield.*

Periodically check the wiper blade for excessive wear and replace the wiper blade as needed. It is always a good idea in rain prone environments and areas of high seas to store an extra set of wiper blades on board.

When you press the “wash button” below the wiper icon on the wiper switch fresh water from the potable tank is pumped through the wiper housing and onto the windshield. This cycle is triggered by a solenoid located near the wiper motors under the headliner.

## Windshield Door Latch



When underway keep windshield door closed and latched. Read and understand the caution label below.

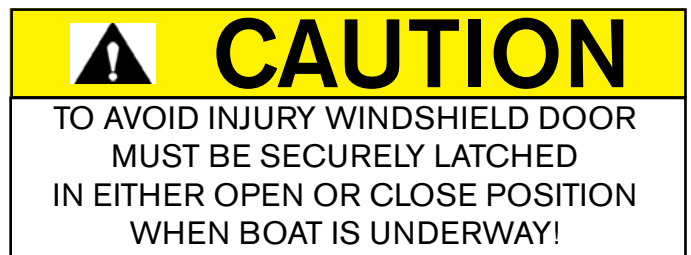

# Chapter 8

## **Cosmetic Care & Maintenance**

### **Cosmetic Care Introduction**

This section covers the care and maintenance of your Regal boat. Many cosmetic care topics including exterior hardware, upholstery, fiberglass and canvas are covered along with major equipment and systems. Refer to the owner's information packet and the appropriate outboard engine manufacturer's manuals for further detailed instructions.

## Acrylics

The companionway door is one item made from a heavy acrylic material. Use warm water and a couple drops of mild detergent. The cleaning rag should be lint free and thoroughly rinsed. Do not substitute paper towels, which could lead to fine scratching of the surface. With the right cleaning materials, you can easily remove most dust and grime without creating an additional static discharge.

Do not use an abrasive or scouring pad. Acrylic must not be exposed to organic, oil-based solvents.

This includes:

- Acetone/nail polish remover
- Paint thinner or comparable
- Benzene
- Rubbing, denatured, or other alcohol-based solutions
- Carbon tetrachloride

For scratches and other marks that do not respond to basic cleaning, polishing is the way to renew your acrylic. Again, use a soft, lint-free cloth. You can hand polish or use a polishing machine.

Apply the polish in a snake like S pattern across the surface first horizontally and then vertically. Smaller polish jobs can use an L shape followed by a circular motion. If you are still not able to remove the blemish the scratch is probably too deep. In these situations, the only recourse is an incremental wet sanding, finishing with an #800 grit abrasive, and another coat of polish.



## Canvas

Boat canvas is in most cases subjected to more severe punishment than practically any other type of material. Moisture, dirt and chemicals from industrial fallout, heat, ultraviolet rays and salt water are all factors which accelerate the deterioration of your boat canvas. These elements can cause serious damage if left unchecked.

The boat top and other canvas supplied on your Regal boat are manufactured from top quality materials to provide you with years of trouble free service. The following information on the care, cleaning and proper storage of the fabrics and fasteners that make up your marine canvas is being provided to help you maintain the appearance and ease of operation.

## Sunbrella Canvas- General Information

Sunbrella is used on bow and aft manual sun shades (if installed). Sunbrella is a woven fabric made from 100% solution dyed acrylic fiber. It is color fast and will withstand long term exposure to the sun (ultraviolet rays) without excessive fading.

Even though it is treated with water repellency some "misting" through the fabric is typical. With new canvas, the greatest potential for leakage is through any sewn seams. Because Sunbrella and the long term thread used is synthetic, the holes created by sewing will not swell up and seal when exposed to water as cotton does. Usually the movement of the fabric in use will move the fibers enough to seal the holes. You may apply Apeal or Uniseal to the seams to speed up this process.

When the canvas is new, the fit will normally be tight. It is designed this way because Sunbrella stretches as it ages, The initial tight fit allows for a suitable fit for the life of the canvas. The Sunbrella fit will vary slightly in the heat, cold, and rain.

## Sunbrella Cleaning Instructions

Sunbrella canvas should be cleaned regularly before substances such as dirt, roof particles, etc., are allowed to accumulate on and become embedded in the fabric. The fabric can be cleaned without being removed from the boat. Simply brush off any loose dirt, hose down, and clean with a mild solution of natural soap in lukewarm water. Rinse thoroughly to remove soap. **DO NOT USE DETERGENTS!** Allow to air dry.

For heavily soiled fabric, remove the top from the frame.

Soak the fabric in a solution that has been mixed to the following proportions.: 1/2 cup of bleach and 1/4 cup of Ivory or Lux soap (liquid or soap) per each gallon of lukewarm water. Allow the fabric to soak until the bleach has killed the mildew and the stains can be brushed out with a common kitchen scrub brush. Rinse the fabric thoroughly in cold water to remove all the soap. This may require several rinsings. Incomplete rinsing can cause deterioration of sewing threads and prohibit the fabric from being properly retreated. Allow the fabric to dry completely. **DO NOT STEAM PRESS OR DRY IN AN ELECTRIC OR GAS DRYER!** Excessive heat can damage and shrink the fabric since it is heat sensitive.

This method of cleaning may remove part of the water and stain repellent that was applied to the fabric during its manufacture. It is recommended to retreat with such water repellency products as Apseal and Uniseal. We do not recommend any wax based treatments such as Thompson's Water Seal or any of the silicone products such as SC-15 or Aqua-Tite. Wax based products prevent the fabric from breathing, and encourage mildew growth while the silicone products interact with the original fluorocarbon finish and seem to cause a rapid loss of water repellency.

### Clear Vinyl, Zipper & Snap Care

Never store canvas wet or in an unventilated, moist area. Always roll the canvas instead of folding. This is of particular importance on side curtains or any other part with the clear vinyl "glass". Roll the top carefully around the bows and cover with the storage boot provided.

The clear vinyl "glass" used in side curtains, aft curtains, visors, and camper enclosures is very susceptible to heat and cold. Keep vinyl curtains from touching metal tubing to minimize burning the vinyl. If the boat is stored with top, side curtains and aft curtain in place, heat build up inside the boat may discolor the vinyl. To clean the clear "vinyl" glass, use a solution of Ivory or Lux soap, liquid or flakes, and lukewarm water. Allow to air dry. Never use any type of abrasive cleaner as it will scratch the "vinyl" glass. There are many cleaners and scratch removers on the market specifically for clear vinyl. Handle the clear curtains carefully. They are soft and prone to scratching.

Canvas parts are designed with zippers. When zippers are new they can be a little difficult to use. Zip carefully without forcing the zipper or the material. They will loosen with use. A zipper lubricant may be used to help new zippers as well as maintaining used ones. The most vulnerable part of the zipper is the starts. Use care when closing the zipper.

Canvas snap fasteners should be unsnapped as close to the button as possible. Never remove canvas by pulling roughly on the edge of the material. This can damage the canvas as well as the fasteners. Use petroleum jelly on snaps to keep them from developing corrosion especially in harsh environments.

## Fabric- Interior

Clean flat good interior fabrics with dry cleaning fluid style cleaners approved for use with soft fabrics. Allow adequate ventilation and follow the label instructions carefully. Use a soft cleanser with feldspar to clean stubborn marks or stains on wallpaper. Normal interior vinyl such as used on the headliner on cruisers and head clean up with a mild soap and water solution. Rinse immediately with clean water and wipe dry. Always test an area with a cleaner before applying it to a larger area.



## DANGER

AVOID SERIOUS INJURY!  
WAXED GELCOAT SURFACES CAN BE VERY SLIPPERY! DO NOT WAX NORMALLY USED AREAS OF THE DECK, LINER, OR GUNWALES. DO NOT WAX ANY TEXTURED OR NONSKID SURFACES SUCH AS FLOORS, WALKWAYS, STEPS, LADDERS, OR SWIM PLATFORMS. WEAR NON-SLIP FOOTWEAR WHEN WALKING ON VESSEL SURFACES!



## DANGER

AVOID SERIOUS INJURY!  
GEL COAT AND FIBERGLASS RESIN ARE FLAMMABLE! WORK IN A WELL VENTILATED AREA FREE FROM OPEN FLAMES. DO NOT SMOKE!

Routine maintenance is the only practical way to keep the surface of your boat looking shiny and new. Most objects left outdoors will gradually deteriorate from exposure to the sun, water, dust and pollution. Such outdoor exposure can cause your boat's gel coated surface to change or fade. Darker colors tend to fade more rapidly than lighter colors because they absorb more of the sun's rays (ultra-violet and infrared).

Basic maintenance includes monthly washing of the boat's surface to remove normal accumulation of soil and stain.

Use a mild detergent such as dishwasher powder or liquid. Do not use automatic dishwasher detergent. Avoid any kind of alkaline cleaners such as trisodium phosphate (TSP), abrasives, bleaches and ammonia. For best results use cleaners that are recommended for fiberglass.

It is recommended that you wax the gel coat surface twice yearly to prevent loss of gloss and to protect the finish. Use only waxes for fiberglass and follow the label instructions. Apply a 3' x 3' section at a time using clean applicator cloths or a buffing bonnet. When a haze develops, use a power buffer at low speeds (1200-2000 rpm) to remove the haze. Keep the buffer moving to avoid heat buildup. The power buffer is very efficient at removing contaminants from gel coat. Never wax gel coat in the direct sun.



When the washing and waxing as recommended does not restore the shine it may be necessary to use a fine rubbing compound. Do not apply rubbing compound in direct sunlight. A power buffer at low speed does an excellent job to remove impurities from the gel coat that cause dulling. Use light pressure and keep the buffer moving. Re-wax after compounding to buff the surface.

“Hairline cracks” or “spider webbing” could develop in the gelcoat surface of a hull or deck. This can be caused by impact or other factors. Small air pockets or gouges may also occur through normal wear.

These do not affect the strength of the hull or deck and can be repaired by yourself, a marine professional or a Regal dealer.

The affected area should be chipped or sanded away and a thin layer of color matched gel coat applied. This layer is then sanded smooth and buffed to its original luster.

Most minor scratches, nicks, and dents can be removed by compounding the surface. Marine type compounds can be found at most auto body supply stores. Specify a number 25 which is a coarser compound up to a number 55 being less coarse. Various glazes and polishes are available as needed. Ask your marine professional or Regal dealer for more information. Fiberglass hulls are strong but they can be damaged. A fiberglass hull has virtually no internal stresses. Thus when a part is broken or punctured, the rest of the hull retains its original shape. A severe blow will either be absorbed or result in a definite localized break. A break of this nature should be checked and repaired by a marine professional or a Regal dealer.

## Minor Repairs

You will need the following materials for minor repairs:

- Gel coat
- Clear Liquid Catalyst
- Putty Knife
- Razor Blade
- Fine Sandpaper (400,600,1000)
- Wax Paper (to cover repair area)

For minor repairs refer to the following procedure:

1. Clean the area to be repaired and get rid of any wax or grease residues.
2. Clean out scratches, chips, and nicks.
3. Sand area to be repaired so gel coat will bond.
4. In a separate container, measure only the amount of gel coat you will need. Mix a ratio of 2% ratio of catalyst to the amount of gel coat being used (a spoonful of gel coat will require only a drop or two of catalyst). Do not pour any unused portions of the gel coat/catalyst mixture back into either original container.
5. Apply gel coat to area leaving a slight lift above the surface.
6. Cover the area with wax paper. It will help the mixture to set up faster.
7. Remove wax paper and shave off any extra gel coat with a razor blade.

8. After the area is shaved smooth, start with the 400, 600, and finally 1000 grit sand papers.

9. Buff the area with compound, polish and a finish wax. You may notice a difference between the repaired area and the original finish due to the natural weathering process.

## FLIR Camera System



The camera housing and lens will require occasional cleaning. You should clean the lens when image quality degradation is noticed or excessive contaminant build up is seen. Clean the interface between the yoke and base often to prevent the build up of salt deposits and debris.

When cleaning the camera:

1. Do not wipe the lens window with a dry cloth, or with abrasive materials such as scrub brushes or paper as this could scratch the surface.
2. Do not use acid or ammonia based cleaners.
3. Do not use a pressure washer.

Particular care should be taken when cleaning the lens window; this features a protective anti-reflective coating which may be damaged by improper cleaning.

1. Switch off power to the unit.
2. Clean the camera body with a clean, soft cotton cloth. Moisten the cloth and use a mild detergent if required.
3. Clean the camera lens.
  - a. Rinse the lens with fresh water to remove all debris and salt deposits; allow to dry naturally.
  - b. If any residual smears or spots remain, wipe gently the lens window with a clean microfibre cloth or soft cotton cloth.
  - c. If needed use isopropyl alcohol (IPA) or a mild detergent to remove any residual marks or spots.

# NOTICE

THIS PRODUCT CONTAINS NO USER SERVICEABLE PARTS. REFER ALL MAINTENANCE AND REPAIR TO AUTHORIZED FLIR DEALERS. UNAUTHORIZED REPAIR MAY VOID THE WARRANTY.

## Hull Bottom

Never use wire brushes or highly abrasive scouring pads on your hull bottom. It could damage the gel coat surface or the bottom paint. The bottom of your boat needs to be clean since the build up of natural coatings from water or marine life can potentially create drag and affect your boat's performance. Read and understand the following label!

# NOTICE

WIRE BRUSHES, SCOURING PADS, OR OTHER ABRASIVE TYPE MATERIALS AND SOLUTIONS SHOULD NEVER BE USED ON THE HULL OR DECK. THEY CREATE SMALL SCRATCHES THAT COLLECT MARINE GROWTH.



## Metal/Stainless Steel



Stainless steel is an alloy made from nickel, chromium and iron. It has been very successful in marine environments due to its ability to resist rusting. If the stainless steel product such as a bow rail is exposed to elements such as ocean spray it will begin to rust over time.

If your stainless steel shows signs of rusting:

1. Wash with fresh water.
2. Clean with a good quality chrome polish periodically but no less than annually. "Brasso" is another product that works well.
3. Also, using a good quality car wax will provide extra stainless steel protection.
4. For polished finishes that show grit lines an abrasive such as "Scotch Brite" or sand paper can be used. Always test a spot first and "go with the grain".

Do not use harsh solvents or cleaners on stainless steel. Do not use steel wool or wire brushes. They will damage the finish. Do not use any type of acids. To maintain their finish annually polish the stainless steel and other bright works. Use commercially available cleaners for metal and read the labels carefully before use.

Refer to the flyer in the owners information pouch. Most marinas and boating retail outlets carry metal care products.

## Plastic

Use plastic cleaners and polishes recommended for marine use only. Use proper applicators. Read all instructions carefully. Test the product in a small area first. Use a soft rag and always rinse the surface with water. Ammonia based cleaners and abrasives will damage plastic parts.

# NOTICE

AVOID CLEANING PLASTIC SURFACES WITH A DRY CLOTH OR GLASS CLEANING SOLUTIONS CONTAINING AMMONIA. NEVER USE SOLVENTS OR WIPE WITH ABRASIVES.

## Upholstery

Cockpit and interior vinyl require periodic cleaning to maintain a neat appearance and to prevent the build up of dirt, mildew and contaminants that may stain and reduce the vinyl life if they are not removed. The frequency of cleaning depends on the amount of use and conditions to which the vinyl is subjected. Most common stains can be cleaned using warm, soapy water and clear rinses. Scrubbing with a soft bristle brush will help loosen soiled material from embossed surfaces and under welting. If the stains are not removed with the above method use a mild cleaner such as Fantastic. This cleaner should be used only as needed and not the normal means.

With more stubborn stains, rubbing alcohol or mineral spirits may be tried cautiously. Widespread solvent use can severely damage or discolor vinyl. Try to remove stains immediately before they have a chance to penetrate the surface of the vinyl. Powdered abrasives, steel wool, or industrial strength cleaners are not recommended for cleaning our vinyl. Lacquer solvents will cause immediate damage. Dilute chlorine bleach before using. Do not wax the vinyl as it may cause cracking. Always wear protective gloves and make sure there is sufficient ventilation when cleaning vinyl. Wear eye protection. Remember that suntan oil will damage vinyl. Use suntan lotion instead of suntan oil. Exposure to the sun is a natural enemy of vinyl upholstery.

<b>FREQUENT STAINS/CLEAN-UP STEPS</b>	<b>1</b>	<b>2</b>	<b>3</b>
Coffee, Tea, Chocolate.....	B		
Permanent Marker*.....	E	B	C
Household Dirt.....	A	B	
Grease.....	D	B	
Ketchup, Tomato Products.....	A	B	
Latex Paint.....	A	B	
Oil Base Paint.....	D	B	
Mustard.....	A	B	C
Suntan Oil.....	A	B	
Asphalt/Road Tar.....	D	B	
Crayon.....	D	B	
Engine Oil.....	B		
Spray Paint.....	B		
Chewing Gum.....	D	A	
Shoe Polish*.....	D	B	
Ballpoint Pen*.....	E	B	A
Lipstick.....	A	B	
Eyeshadow.....	E	B	
Mildew*.....	C	B	A
Wet Leaves *.....	C	B	A

A= Soft brush; warm soapy water/rinse/ dry

B= Fantastik cleaner

C= One tablespoon ammonia, 1/4 cup of hydrogen peroxide, 3/4 cup of warm water/ rinse/dry

D= Scrape off residue ( use ice to lift gum)

E= Denatured alcohol/rinse/dry

\* These products contain dyes which leave permanent stains.

# Maintenance

## Maintenance Introduction

This section covers select maintenance topics of interest on your Regal boat. Maintenance covered here is basic. Refer to the Regal owner's information packet for additional component manufacturer maintenance schedules and product guides. Also, more detailed information can be found in the Yamaha outboard owner's manual.

Sampling of topics covered here include air conditioning, batteries, dockside cords, fuel systems, galvanic corrosion, and both stern drive and outboard engine information.



## AC Condenser Coil Cleaning

Note: It is best to get an air conditioning expert familiar with marine a/c to do the periodic maintenance mentioned below. The information will assist the technician.

1. With the system turned off at the ship's AC electrical panel, disconnect the inlet and outlet connections of the condenser coil.

2. Use chemical resistant hoses (MAS white PVC 5/8" I.D., etc.) to connect the inlet of the condenser coil to the outlet of a chemical resistant, submersible pump (MAS P-500 pump, etc.) and let the hose connected to the coil outlet flow freely into the container mentioned below.

3. Place a strainer or piece of screen over the inlet of the pump and submerge the pump into a container filled with a 5% solution of muriatic or hydrochloric acid and fresh water or use a premixed over-the-counter solution. Use as large a container as possible to hold the solution (2 to 5 gallons).

4. Power the pump and circulate the solution through the condenser coil for 15-45 minutes depending on the size of the coils and the extent of the contamination. Visual inspection of the solution in the container should indicate when the contamination removal has stopped.

5. Circulate fresh water through the coil to flush any residual acid from the system.

6. Restart the system and check operational parameters to ensure thorough cleaning has taken place. Additional cleaning may be necessary with extreme contamination.

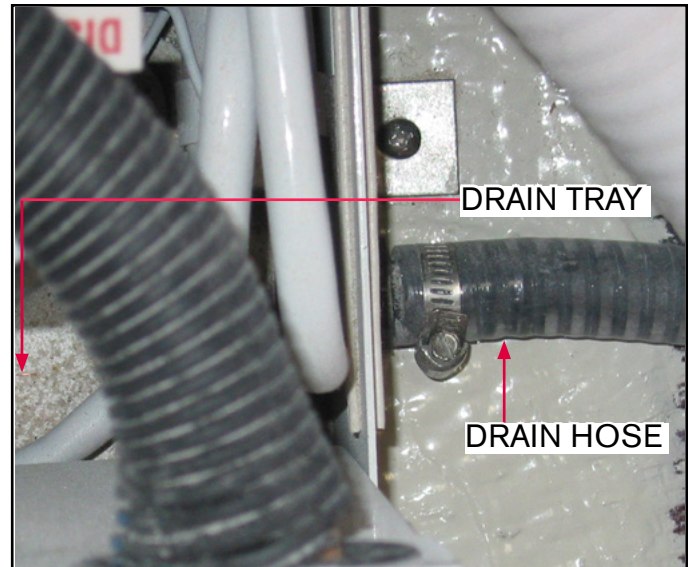

## Air Filters

Check the air filter located at both A/C condensation units monthly and clean as necessary. To clean the filter, remove it from the unit, rinse with water, air dry and reinstall. Blow with compressed air as needed. See the illustration and other chapters of this manual for air filter location on the vessel.

## Batteries



Frequently check your battery terminals for corrosion build-up. If you find a greenish, powdery substance, remove the cable connections and clean

both the both the terminals and the connectors with a wire brush. When the cleaning is finished reconnect the battery cables and coat the terminal with an approved grease or petroleum jelly to help prevent further corrosion.

Check the electrolyte level at least every 30 days, more often in hot weather. The level should be maintained between the top of the battery plates and the bottom of the fill cap opening.

Add distilled water as needed after charging the batteries or periodically as needed. Do not over-fill because sulfuric acid could run over and cause burns or an explosion.

Batteries should be charged outside the boat. Do not smoke or bring flames near a battery that is being or has recently been charged. The hydrogen gas generated by battery charging is highly explosive. Set batteries on a block of wood rather than concrete since this procedure will help the batteries from losing their charge.

Do not allow a metal object or loose wires to spark across battery posts while working close to the battery. Contact across terminals will cause a short circuit and personal injury may result.

Tighten all battery connectors securely. Check their tightness by pulling on the connectors. They should not move from their tightened position. Be sure to reinstall the positive boot over the battery terminal after tightening the battery post connection. While using the boat, use the volt meter to monitor the charge level of the battery. Monitor the charge with the engines turned off (static condition).

The engine alternators recharge the batteries. A fully charged battery will indicate between 12.3 and 12.6 volts on the voltmeter. Readings below this could indicate a dead battery cell or a charging system malfunction which should be checked by a marine professional.



## WARNING

**AVOID SERIOUS INJURY!**  
BATTERIES CONTAIN SULFURIC ACID (POISON) WHICH ALSO CAN CAUSE BURNS. AVOID CONTACT WITH THE SKIN, EYES, AND CLOTHING. IF CONTACTED, FLUSH WITH WATER FOR AT LEAST 15 MINUTES. IF SWALLOWED, DRINK LARGE AMOUNTS OF WATER, OR MILK. FOLLOW UP WITH MILK OF MAGNESIA, BEATEN EGG, OR VEGETABLE OIL. GET MEDICAL ATTENTION IMMEDIATELY!



## WARNING

**AVOID SERIOUS INJURY!**  
WEAR GOGGLES, RUBBER GLOVES, AND A PROTECTIVE APRON WHEN WORKING WITH A BATTERY. BATTERY ELECTROLYTE CAUSES SEVERE EYE DAMAGE AND SKIN BURNS. IN CASE OF SPILLAGE, WASH AREA WITH A SOLUTION OF BAKING SODA AND WATER.

Make sure all terminals are clean. As discussed earlier, a battery cleaner tool along with a toothbrush should be used to clean both the positive and negative terminals. Use a small amount of baking soda and water. Remove any acid residue from the terminal area and battery top with a damp cloth. Be sure to wear plastic gloves and eye protection. See the illustration.

Install an anti-corrosion lubricant to the posts before reinstalling the terminals. This lubricant is available as a paste or spray type and can be found at most marina or auto supply stores.

Be sure to reinstall any red (+) battery (anti-short) boots on the battery terminals.

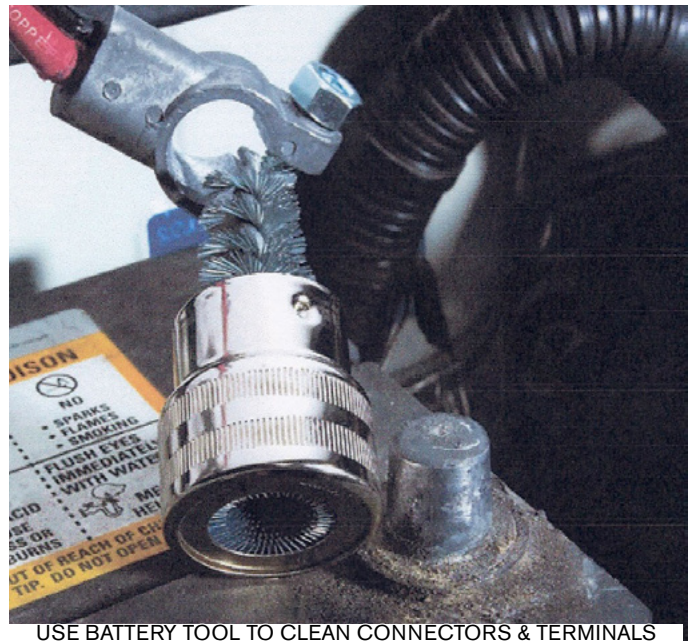



## Dockside Cords

### 1. GENERAL INFORMATION

To minimize shock and fire hazards:

- a) Turn off the boat's shore connection switch before connecting or disconnecting shore cable.
- b) Connect shore power cable at the boat first.
- c) If polarity warning indicator is activated, immediately disconnect cable.
- d) Disconnect shore power cable at shore outlet first.
- e) Close shore power inlet cover tightly.
- f) DO NOT ALTER SHORE POWER CABLE CONNECTORS

### 2. STORAGE

This cable set is intended for use outdoors. To prolong the life of the cable set, store under cover where not exposed to sunlight or weather when not in use.

### 3. PREVENTIVE MAINTENANCE

Most boat owners are faithful in the care and maintenance required to insure their boat's beauty and sea-worthiness. However, they often overlook the maintenance of its "dockside life support system" — the AC shore power system.

The boat's shore power inlet, cable set and adapters, and the dockside receptacle require a minimal amount of time and effort to inspect and maintain. Doing so can prevent power interruptions to the conveniences supplied as original equipment or those added later. There are a few basic checks, but before performing any maintenance on these items, make sure you turn off the boat's main shore power switch and disconnect the cable set from the dockside power source.

The metallic parts of marine wiring devices are made to resist corrosion. In a salt water environment, the life span of the devices can be increased by periodically rinsing the exposed parts in clean water, drying them completely and spraying them with a moisture repellent before using the devices again. This process should especially be followed if either the boatside or dockside connector is ever accidentally immersed in salt water. It is imperative that all salt water or brackish water be cleaned from a device before reusing it. A common cause of failure is the result of contamination on a device in one of two forms. The first is contamination of the device's contacts (with corrosion, dirt, etc.) which impedes the flow of electricity, leading to overheating and possible failure. The other type is contamination (salt, water, etc.) of the face of the device which allows current to flow across an insulating surface causing a short circuit.

This brings up a common but often misunderstood problem — the "bad plug/bad receptacle syndrome". The basis of the problem is that if a bad device is mated to a good one, then the good device can be rendered inoperative.

A high-resistance connection can be made between the contaminated contacts on the bad device and its mating contacts on the good device.

Many people think a problem like this occurs because the connected devices cannot carry their rated current load. This is not true. The overheating results from the current passing through a poor connection. This high-resistance connection gradually degrades as arcing occurs and "pits" the contacts which adds to the problem. This type of connection can heat up to a point where the metal contacts melt away and the insulating body burns. If you ever experience this problem to any degree, make sure both devices are replaced. If only one device is replaced, the other bad device will cause the process to be repeated.

The key to the situation is inspection. Periodically check all device exposed contacts for "pitting", burn or "flash" marks, or signs of deterioration/discoloring of the plastic. If any of these conditions exist, there is an indication of poor contact or high resistance connections and the devices should be replaced. When docking at a marina other than your home berth, it is a good idea to check for a bad receptacle by feeling the plug after 15 minutes and again after an hour. If the plug feels uncomfortably warm to the touch, a bad connection is indicated. Contact the dockmaster immediately.

The third common cause of failure in dockside power devices is the result of the mechanical abuse of devices. If the exposed contacts of the plug are misaligned due to abuse (such as being bent when dropped, stepped on, or run over) and are not realigned before connecting to the mating device, the contacts on the mating device can be distorted and possibly fail. Making sure that exposed male contacts are in the same position as they were when new will prolong the life of mating devices.

One final area of concern is the appearance of the yellow vinyl jacketed cable on dockside power cable sets and adapters. A soiled cable can be cleaned with a grease cutting household detergent or a good vinyl cleaner. A periodic application of a vinyl protector will help the cable keep its original appearance.

**WARNING:** This product contains chemicals, including lead, known to the state of California to cause birth defects or other reproductive harm.

***Wash hands after handling.***



## Fuel System

At least annually inspect all fuel system components for loose clamps at the vent, fill and feed locations. Access to the above components is in the forward bilge near the firewall. Examine each hose for signs of deterioration and leakage. Check the fuel sender for loose bolts, nuts, and leaks at all areas of contact. Ensure the sender ground wire is tightly fastened. Note the photos for gas and diesel tank senders.

Also, inspect the fuel tank for signs of leakage or abrasion especially at welded joints on metal tanks and all hose clamps. Tighten all components as needed.

Be sure to check all system fuel filters for water and debris on an on-going basis.

If fuel is to be stored in the fuel tank for an extended period of time (winter) make sure you add the proper amount of fuel additive (stabilizer) to the fuel tank.

 **WARNING**

AVOID SERIOUS INJURY OR DEATH DUE TO  
FIRE OR EXPLOSION RESULTING FROM  
LEAKING FUEL!  
INSPECT ENTIRE FUEL SYSTEM  
AT LEAST ONCE PER YEAR.

PORT COCKPIT SEAT

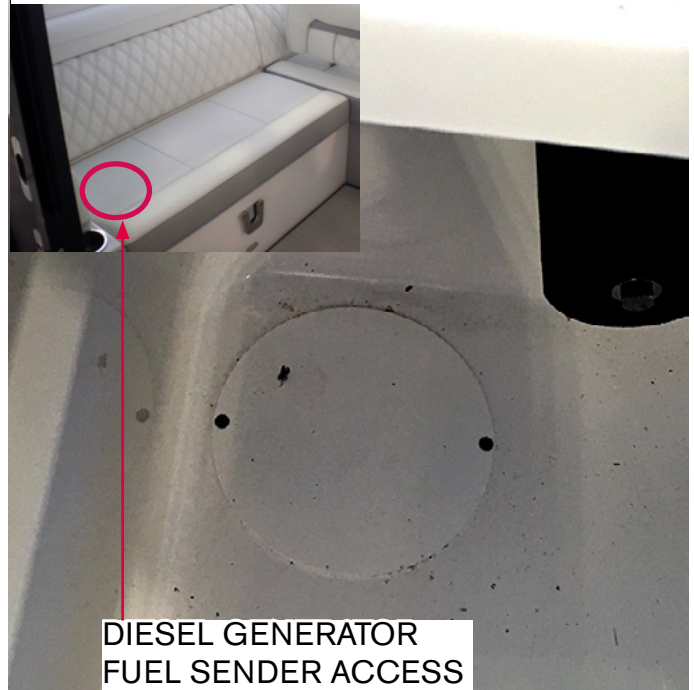

DIESEL GENERATOR  
FUEL SENDER ACCESS

At the back side base of the port cockpit seat is an access plate to inspect the diesel fuel tank sender (if diesel generator option is installed).

Inspect all components at least once per year.

At the aft end of the patio seat base is an access to the gasoline fuel tank sender. Inspect all components at least once per year.

PATIO SEAT

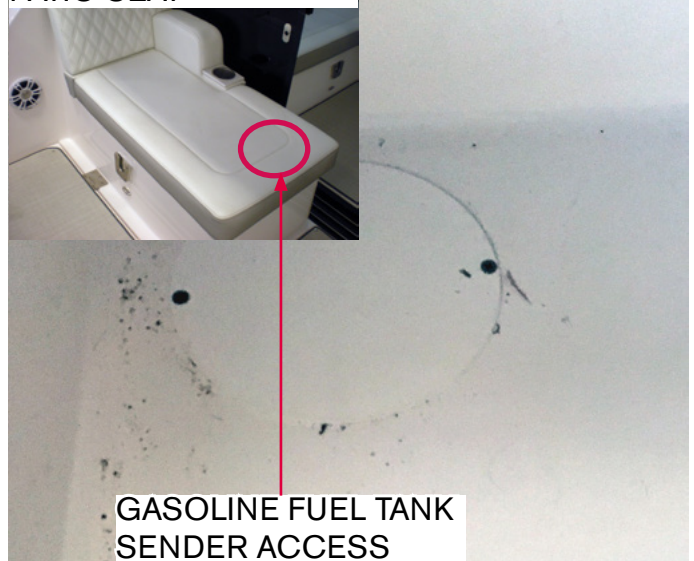

GASOLINE FUEL TANK  
SENDER ACCESS

## Galvanic Corrosion/Stray Current

Metal parts underwater can be subjected to two basic styles of electrolysis: galvanic corrosion and stray current corrosion. Both can damage the outboard drive, propeller, underwater parts, boat and motor if not correctly monitored (testing at 2 week intervals) and avoided.

Galvanic corrosion is an electrochemical reaction between two or more metals. Drive systems consist of several different metals. Some are more active than others.

Galvanic corrosion of the more chemically active metals can occur whenever two or more dissimilar metals that are “grounded” (connected by actually touching each other, or through a wire or metal part) are immersed in a conductive solution (any material that can conduct electricity). Anything but pure water is conductive. Saltwater, fresh water with a high mineral content and polluted freshwater are highly conductive. Conductivity increases with temperature. That is why Florida boats experience more corrosion than boats in Maine.

Specifically look at a typical outboard marine drive unit with a stainless steel propeller. The aluminum is the more chemically active metal (called the anode) and the stainless steel propeller is the less chemically active metal (called the cathode).

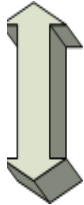
CORROSION TABLE	
Gold	 <p>Least Active</p> <p>Most Active</p>
Stainless Steel	
Bronze	
Copper	
Brass	
Steel	
Aluminum	
Zinc	
Magnesium	

Typically electrons flow from the anode (the aluminum drive unit), via the external conducting path to the cathode (stainless steel propeller). If there is a very large anode connected to a small cathode, the anode will corrode very slowly. If a very large cathode is connected to a small anode, the anode will corrode very quickly. Obviously, if you do not control galvanic corrosion, over time the aluminum will corrode away.

The first sign of galvanic corrosion is paint blistering (starting on sharp edges) below the water line- a white powdery substance forms on the exposed metal areas. As the corrosion advances, the exposed metal will become deeply pitted as the metal is actually eaten away.

Another condition which will increase galvanic corrosion is the removal or reduction in surface area of the sacrificial anodes. Never add aftermarket products that are connected to the engine ground such as stainless steel steering aids and trim planes.

Zinc connected to aluminum will form a corrosion cell but the aluminum (drive) becomes the cathode and the zinc (anode) corrodes.

Even though your boat may not have shore power aboard current from nearby vessels with shore power can produce stray current galvanic corrosion. Stray current corrosion occurs when metal with an electrical current flowing into it is immersed in water that is grounded (lake, ocean, pond). The current can leave the metal and flow through the water to ground. This will cause rapid corrosion of the metal at the point where the current leaves.

When a vessel nearby is plugged into shore power, they can potentially tie your outboard drive unit to their boat via the green grounding shore power lead. Your outboard drive unit could be the receiving end of a large galvanic cell (a battery) interconnected with nearby vessels or even through the marina's metal structures via their electrical system.

The vessel should be tested every couple of weeks to determine the integrity of the anode protection system. Another way to test the system is to measure the hull potential. This is accomplished by immersing a reference electrode, usually a silver/silver chloride into the water about six inches behind the outboard drive. With leads attached to a digital multi-meter the hull potential is read on the DC scale and compared to recommended specifications for the water body type. See the owner's information vendor packet for more information or contact your nearest authorized Regal dealer.

#### Tips To Aid In Maintaining Galvanic Integrity

1. Test the galvanic integrity of your vessel every 2 weeks. Raise the drive and inspect anodes/parts for signs of galvanic corrosion, stray current corrosion or loose fasteners. Contact your closest Regal dealer/marine professional where signs of galvanic corrosion exist.

2. Never paint over anodes as they will become inoperative. Always leave at least one inch between bottom paint and any underwater fitting such as sea cocks, swim platform stanchions and all drive and propulsion related underwater parts.

3. Periodically remove vessel from water and clean/pressure wash all outboard, anode and hull bottom areas to remove growth.

4. Ensure vessel is using the correct anode metal for the body of water that it is moored. See the outboard engine manufacturer's manual for more information or contact an authorized dealer.

5. Ensure that the drive is completely "in" down to provide more complete anode protection when vessel is moored.

6. Do not attempt to use magnesium anodes in saltwater. They will provide over protection.

7. If marina moored, contact appropriate personnel if signs of galvanic corrosion appear on your drive system. Ask them to check for stray electrical current which may be originating from a nearby vessel's faulty DC wiring or from a marina pier, piling or dock carrying leaking marina ground wiring such as a dock side cord partially submerged.

<b>GALVANIC/STRAY CURRENT CORROSION</b>	
<b>Cause/Observed Condition</b>	<b>Corrective Action</b>
Sacrificial anodes consumed	Replace anodes when 30% consumed
Sacrificial anodes not grounded to drive	Remove anodes, clean contact surface, reinstall, check for continuity
Loss of continuity between underwater parts & ground	Provide good ground connections
Nearby vessel with stray current	Contact appropriate personnel Remove your vessel from water
Paint on drive heavily worn, exposing more metal	Prime and repaint or install additional anodes
Sacrificial anodes painted	Remove paint or replace anodes
Drive tilted/anodes out of water	Leave drive down, install additional anodes below water
Power trim cylinders only corroded	Provide a good ground to drive, all parts must be grounded
Corrosion in area of exhaust outlets	Remove deposits
Corrosion occurring after vessel is removed from saltwater	Wash exterior and flush interior with freshwater
Stainless steel parts corroding	Clean parts, remove foreign material, ensure continuity
Underwater drive parts corroded, sacrificial anodes OK	Oxide film on anode (fresh water only) Replace anode Poor ground. Scrape anode



Sacrificial zinc anodes may be located on outboard and stern drive housings, trim cylinders and/or prop shaft to protect softer metals exposed to the water. Electrolysis attacks the least noble metals first. Because zinc is a less noble metal, it will decompose before other metals. Check these zinc anodes periodically and have them replaced when they are 30% consumed. Notwithstanding, zinc is the most popular metal used to protect parts that are exposed to saltwater, freshwater or brackish water. See the photos below for anode location on your outboard.

Zinc anodes in brackish or salt water need to be checked more frequently. If the anodes seem to be requiring frequent replacement there may be a boat leaking DC current into the water taxing the anodes. This is especially possible around a marina environment. Contact a marine professional who can measure the galvanic activity with a special electrode and electric VOA meter. Refer to the engine manufacturer's manual for exact anode location and detailed information.

Inspect the ground leads for tightness if attached.

*Note that parts damage due to galvanic or stray current corrosion is not covered under warranty.*

*Never paint anodes as they will lose their sacrificial abilities in galvanic corrosion control.*

*Note in the above photo the trim tabs use zinc anodes. Check with trim tab manufacturer for periodic inspection and replacement information.*



TYPICAL STERN DRIVE ANODE LOCATION

TYPICAL OUTBOARD ANODE LOCATION

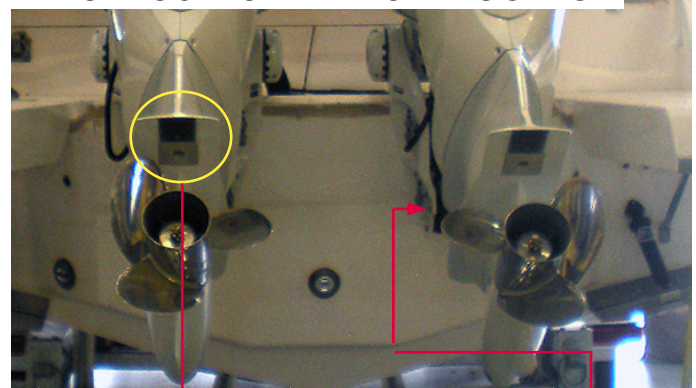

UNDER CAVITATION PLATE STEERING HSG.

## Remote Control



Check the helm control box and make sure there is no roughness or tightness when shifting. Also, check to make sure the control box hardware is tightly secured. The shifting is done by a process called “fly by wire” Being the engines use electronics to shift it should be effortless. An application of silicone spray on the handles will help fight any corrosion.

Remember there are no actual mechanical shift and throttle control cables on your vessel. There is a friction control under the cover which may be altered to personal needs. Refer to your Yamaha manual or contact your closest authorized Regal dealer for further remote control information.

## Seating



Care of your seating includes periodic cleaning with products which are non-corrosive and are recommended for vinyl. Select seats use rams and hardware which needs to be periodically checked for tightness. See the cleaning vinyl section for more information.

## **Stereo**

The Fusion® stereo head unit requires little maintenance. When washing the cockpit, do not discharge water directly at the stereo unit. Possible damage may result. As with any CD unit clean your CD's to keep them from skipping. This process also aids in keeping dust out of the unit.

For further information, refer to your stereo owner's manual located in the owner's packet.

## Engine Maintenance-Stern Drive

A select portion of stern drive propulsion maintenance items are covered in chapter 5 including overviews of critical systems and ***checks of essential component lubricant levels.***

Since advanced ignition and fuel injection systems are used on stern drive engines along with special factory training and tools it is recommended to contact your authorized Regal dealer for more of the detailed service procedures and/or refer to your Volvo operator's manual for more detailed customer care information.



## Engine Maintenance-Outboards

A select portion of outboard maintenance items are covered in this chapter *mainly checking critical component lubricant levels.*

Since advanced ignition and fuel injection systems are used on outboard engines along with special factory training and tools it is best to contact your authorized Regal dealer for more of the detailed outboard service procedures and/or refer to your Yamaha outboard owner's manual for further customer care information.



### CAUTION

AVOID ENGINE DAMAGE!  
DO NOT RUN OUTBOARD ENGINE  
AT A CONSTANT RPM FOR PROLONGED  
PERIODS OF TIME DURING BREAK-IN  
PERIOD. CHECK ENGINE OIL OFTEN.



### CAUTION

AVOID ENGINE DAMAGE!  
DO NOT RUN OUTBOARD ENGINE  
OUT OF WATER UNLESS YOU USE  
AN OPTIONAL FLUSHETTE.  
FOLLOW MANUFACTURER'S ATTACHING  
AND RUNNING INSTRUCTIONS!



### CAUTION

AVOID ENGINE DAMAGE!  
FOLLOW ALL BREAK-IN PROCEDURES  
RECOMMENDED BY THE ENGINE  
MANUFACTURER. FAILURE TO FOLLOW  
BREAK-IN PROCEDURES MAY VOID  
THE OUTBOARD ENGINE WARRANTY.

## Yamaha Care Component Description

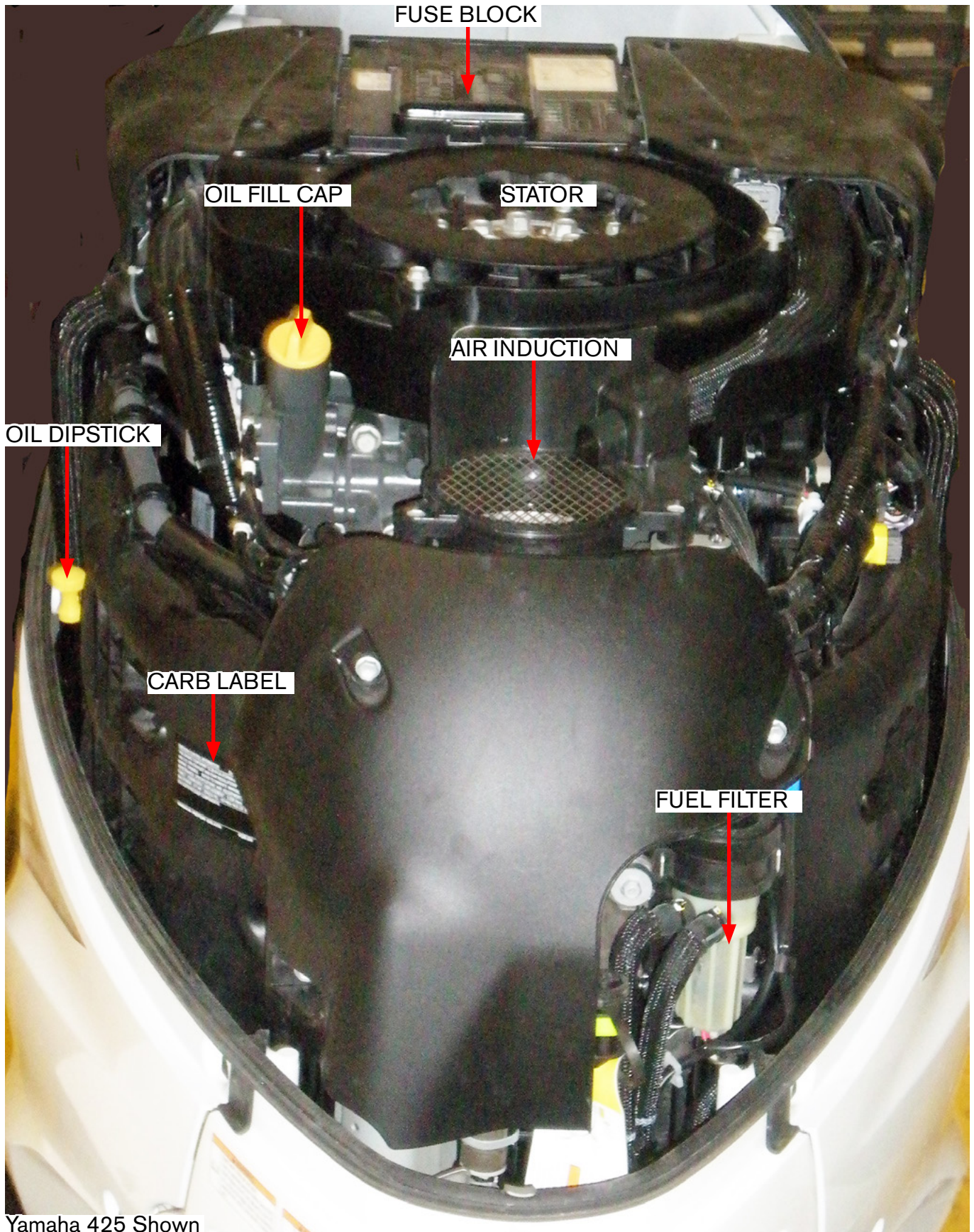

Yamaha 425 Shown



## Checking In-Line 10 Micron Water Separator Filter



Periodically before embarking on a cruise check the fuel filters. A 10 micron in-line water separator filter for each engine is installed in the aft bilge. Use an oil spanner type wrench and turn the filter

counterclockwise to remove the element. With a clean pan empty the filter contents into it. Water in fuel tends to hug the bottom and will show a different color than the fuel. At least yearly or on an as needed basis replace the filter element. Fill the element up with fresh unleaded fuel of the correct octane rating and turn it clockwise until tight. Finish tightening with the spanner wrench. As always check for leaks before starting the engine.

It is recommended to keep extra filter elements on board in protective wrap for emergency use.

## Checking Engine Mounted Fuel Filter

As part of select outboards under the motor shroud (engine cover) on the lower port side of the outboard engine is a fuel filter. Periodically check to ensure the fuel filter is free of debris and contains no water.

*Note that the fuel filter housing needs to be removed from the bracket allowing access to the fuel filter element.*

When reinstalling the filter tighten to manufacturer's specifications. Check for leaks after starting the engine. For more information refer to the Yamaha owner's manual or contact an authorized Regal dealer or marine professional.



FUEL FILTER ELEMENT  
INSIDE FILTER BODY

## Checking Engine Crankcase Oil

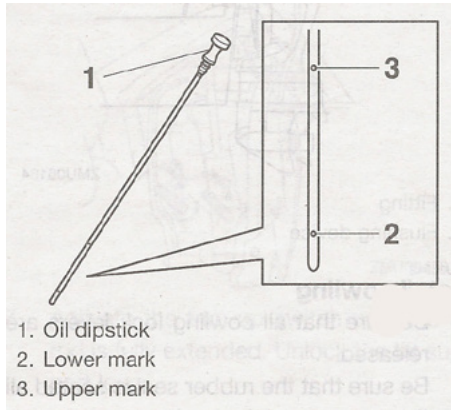

Your Yamaha outboard features 4 cycle engine operation. Unlike 2 cycle outboards which mix gas with oil

technology, the 4 cycle engine uses crankcase 4 cycle oil to lubricate internal moving parts. This operation is similar to automobile engine technology. As part of this process, there is a dipstick placed in the crankcase to offer periodic checking of engine crankcase oil.

To check the crankcase oil do the following:

1. Ensure the outboard is setting in a flat vertical position or the dipstick may not display an accurate oil level.
2. Remove the crankcase oil dipstick and wipe it clean.
3. Reinstall the crankcase oil dipstick completely into the hole. Remove it again.
4. The oil level should be between the upper and lower dipstick holes. .As needed add the manufacturer's recommended oil or contact your closest dealer especially if the oil is contaminated with water which will show a milky color verses a clear look. Refer to the outboard manufacturer's owners manual for oil changing maintenance schedules.

## Checking/Filling Crankcase Oil- (Cont.)

When adding crankcase oil be sure to utilize the manufacturer's recommended type and viscosity. For changing crankcase oil contact your closest Regal dealer for additional information since they have the special tools and knowledge for these maintenance procedures.

Note that oil fill plug location may vary by engine model. Refer to the Yamaha owner's manual for further information.

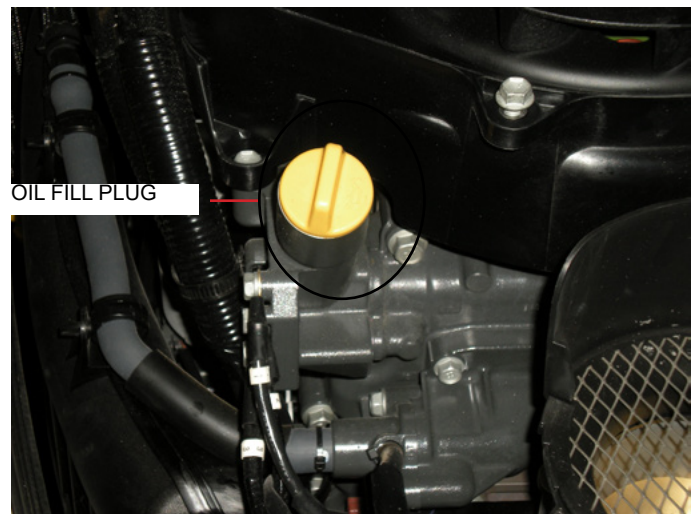



## Flushing Device

Your Yamaha outboard features a flushing device which when connected to a garden hose circulates fresh water through the engine to purge unwanted debris such as found in salty, brackish, and silty water.

To use open the flushing device by turning it counterclockwise. Notice there is a garden hose bib thread. Attach the male end of a garden hose to the fitting and tighten it. Make sure the fitting does not leak as the power head could overheat and cause internal damage. It is best to perform this flushing procedure with the engine still warm from a cruise as the thermostat will be open and will permit more efficient water circulation. Turn on the fresh water supply. When flushing completed remove the garden hose from the fitting and reattach the hose connections and of course check for tightness.

*Note not to start engine during this procedure as overheating and engine damage may occur.*



*Note that flushing device type and location may vary by engine model. Refer to the owner's manual for further information.*



**YAMAHA 425 SHOWN**

## Fuse Box/Cover Plate w/Fuse Identifier

As part of Yamaha outboards under the motor shroud (engine cover) on the port side or on top of the outboard engine is an electrical fuse box. Inside its cover is a variety of fuses protecting various engine components. There are also extra fuses stored along with a fuse puller. For further information, refer to the manufacturer's outboard engine manual.

*Note that fuse location may vary by engine model. Refer to the Yamaha outboard owner's manual for further information.*

## Engine Alarms/Alerts

The Yamaha display unit shows engine status and is a early warning system for the operator to recognize engine problems.

***Do not continue to run engine if an alert or alarm has activated.***

Contact your authorized Yamaha dealer if the problem cannot be remedied or found.

### **Common alerts include the following:**

1. Low oil pressure
2. Low fuel pressure
3. Water separator filter (accumulated water)
4. Low cooling water pressure
5. Low battery voltage
6. Steering malfunction
7. Engine trouble

***Do not continue to run engine if an alert or alarm has activated while cruising. Stop the vessel, turn off the engines and investigate the problem.***

If situation cannot be remedied return to port and contact your nearest Yamaha dealer.

## Propellers

Out-of-balance and nicked propellers will effect performance or cause vibration. Damaged props should be replaced, but those that are chipped or bent can usually be reconditioned by a marine dealer or a propeller repair facility. When cruising, consider carrying a spare set of props on board because many marinas do not carry a full inventory of replacement propellers. Also, carry an extra set of prop hardware. Refer to the outboard manufacturer's engine manual for appropriate propeller replacement.

Be sure to make a note of the propeller diameter and pitch while the vessel is in dry dock. They are pressed into the prop for easy reading.

Also, note that select propellers feature a rubber hub pressed into the center propeller that includes the hole for the prop shaft to slide through. Sometimes as a result of impact the rubber hub becomes damaged and the propeller will not let the boat perform to the rated revolutions per minute (rpm). In an emergency a stainless propeller blade may be straightened by laying the propeller blade on a 2 x 4 and hammering the bent portion of the blade until straight.



It is advantageous to carry the needed tools to change propellers including pliers to pull cotter key and deep socket and ratchet to remove the propeller shaft nut. See the appropriate outboard manufacturer's owner's manual for further information.

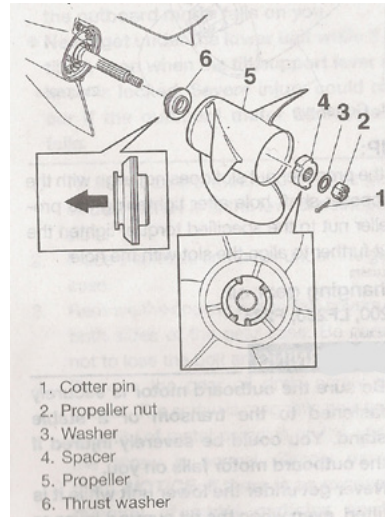

Removing the propeller- Before removing the propeller make sure the remote control is in neutral and the ignition keys are removed to prevent the outboard engine starting and possibly causing bodily injury.

Always wear gloves

when removing or installing propellers since the component blades are very sharp.

1. Use pliers to straighten the cotter key which will permit it to be pulled through the prop shaft.

2. Do not use your hand to hold the propeller while removing the nut.

3. Wedge a 2 x 4 between the skeg and the propeller. Then use a deep socket and ratchet to remove the propeller nut.

4. Next, remove the washer and spacer. Remove the propeller. Remove thrust washer and see note below.

Note: Check the prop shaft seal behind the propeller for fish line and debris that could cut prop shaft seal.

Installing propeller- Before installing parts back on to the prop shaft make sure you lubricate the prop shaft with the recommended lube.

1. Install the thrust washer on the prop shaft first as indicated in the illustration above. Then install the propeller.
2. Align the spacer protrusions with the cutouts of the propeller.
3. Install the spacer, washer, and propeller nut. Tighten the propeller nut to manufacturer's recommended foot pounds with a torque wrench.
4. Next, line up the protrusions on the spacer with the cut outs on the prop itself.
5. Align the propeller nut slot with the prop shaft hole.
6. Install a new cotter key and carefully bend the cotter pin ends over .

Note: Using an old cotter key increases the chances of the propeller working itself off the shaft since the cotter pin ends become stressed and weak after being bent over and constant engine vibration weakens the cotter key ends.

Note: If the prop shaft nut does not line up to insert the cotter key, tighten the nut to the point where it does line up with the prop shaft.

See drawing on previous page or refer to the Yamaha owner's manual for detailed information.

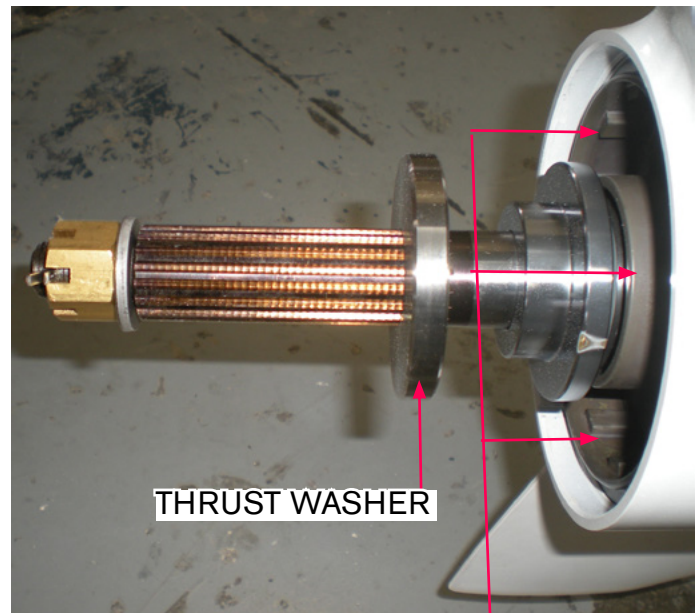

INSPECT SEAL AREA INSIDE EXHAUST HSG. & BEHIND THRUST WASHER FOR FISH LINE



# Chapter 9

## Troubleshooting

The following diagnostic information will assist you in identifying minor electrical, fuel, and mechanical problems. Some of the items listed require technical training and tools. Additional assistance is available in the outboard engine manufacturer's owner's manual. Also, you can contact your closest Regal dealer or marine professional for more information.

Sometimes a problem can be solved by performing a logical sequence of elimination and/or root cause techniques.



### **WARNING**

AVOID SERIOUS INJURY OR DEATH!  
BEFORE PERFORMING ANY MAINTENANCE  
WORK, TURN OFF THE BATTERY SWITCH  
AND REMOVE THE IGNITION KEY  
FROM THE SWITCH.



### **WARNING**

AVOID SERIOUS INJURY OR DEATH!  
USE ONLY APPROVED MARINE  
REPLACEMENT PARTS THAT  
ARE IGNITION PROTECTED.

# ENGINE DIAGNOSTIC CHART

<b>Problem</b>	<b>Possible Cause</b>
Engine Overheating	<p>Water pick-up feeds are blocked by debris</p> <p>Cooling system leak</p> <p>Impeller is worn or blocked by debris</p> <p>Propeller is over propped for the circumstances, causing the engine to work extra hard</p> <p>Debris in oil is holding heat more than normal - bad oil filter</p> <p>Defective thermostat</p> <p>Low octane fuel</p>
Starter Will Not Crank	<p>Battery weak or dead</p> <p>Starter defective</p> <p>Fuse for electric start relay blown</p> <p>Control not in neutral</p> <p>Defective start panel button</p>
Excessive Steering Play	<p>Air in steering lines (Bleed)</p> <p>System low on steering fluid</p> <p>Mechanical parts-loose connection</p>

# ENGINE DIAGNOSTIC CHART

Problem	Possible Cause
No Power To Helm	Battery switch turned off  Batteries are weak or dead.  Main breaker tripped  Loose connection
Engine Cranks But Will Not Start	Fuel flow obstructed/water in fuel  Low battery voltage  Engine ignition system malfunction  Timing belt broken  No fuel in tank  Safety lanyard not attached  Control not in neutral
Hard Starting	Vacuum In Fuel System  Fuel lines obstructed  Water in fuel  Debris in fuel/clogged fuel filter
Engine Idles/ Runs Rough	Fuel quality  Faulty spark plugs  Fuel contaminated/ clogged anti-siphon

# ENGINE DIAGNOSTIC CHART

<b>Problem</b>	<b>Possible Cause</b>
Power Loss	Damaged propeller  Improper trim angle  Spark plugs fouled  Fuel system malfunction  Hull bottom fouled with debris  Excess water in bilge (leak)  Low Octane Fuel
Excessive Vibration	Damaged propeller  Damaged propeller shaft  Loose/broken motor mount  Steering pivot loose or damaged  Debris caught on propeller  Ignition malfunction  Motor mount bolts loose (transom)



# ENGINE DIAGNOSTIC CHART

<b>Problem</b>	<b>Possible Cause</b>
Buzzer Sounds/Icon Lights	Cooling system malfunction  Engine oil level low or incorrect type  Wrong spark plug heat range  Oil feed pump malfunction

# DC ELECTRICAL SYSTEM DIAGNOSTIC CHART

Problem	Possible Cause
No 12 Volt Power At Battery	Battery switch turned off  Weak or dead battery  Battery cables loose/disconnected
Battery Not Charging While Engine Is Running	Faulty stator  Faulty circuit wiring
Battery Will Not Hold Charge	Faulty/ old battery  Loose battery cables  Corroded battery terminals
12 Volt Equipment Not Working	Fuse blown-Take time to investigate why the equipment was drawing too much current or why it had a short circuit. Check fuses at fuse block and under the engine shroud  Weak or dead battery if all 12 volt equipment fails to function.  Corroded / loose wire connection  Internal equipment short /failure

# AC ELECTRICAL SYSTEM DIAGNOSTIC CHART

<b>Problem</b>	<b>Possible Cause</b>
No Voltage At Main AC Panel	Ships dock side cord not plugged in  Dock side breaker tripped  ELCI breaker tripped  Faulty dock side power cord
AC Panel Indicates Reverse Polarity	Dockside wires reversed at marina power supply.
No Voltage At GFCI outlets	GFCI outlet tripped (reset)  Outlet breaker off at AC main ship's panel  Unplug faulty equipment-short
Main AC Panel Breakers Trip When All Equipment Is Energized	Turn off equipment as needed to balance load on shore 1 and shore 2

# Chapter 10

## Storage & Winterization

Storage procedures are outlined in this chapter. These are general guidelines to follow before longer periods such as over the winter in colder climates. Be sure to familiarize yourself with all relevant information in the owner's sacht.



TYPICAL VESSEL ABOVE SHOWING HULL SUPPORTED BY TRAILER

Special winterization procedures are necessary for the boat equipment and systems. Use the enclosed checklists to help you identify areas of concern and maintenance. Call a Regal dealer or marine professional for further information regarding storage/maintenance procedures. Also, more specific information can be found in the outboard engine manufacturers owners manual.



### WARNING

AVOID SERIOUS INJURY OR DEATH  
DUE TO FIRE AND EXPLOSION!  
DO NOT FILL FUEL TANK TO RATED  
CAPACITY. LEAVE ROOM FOR EXPANSION.

### NOTICE

REMOVE BATTERIES WHEN VESSEL  
IS IN LONG PERIODS OF STORAGE  
ESPECIALLY IN COLD CLIMATES  
BATTERIES CAN FREEZE AND POSSIBLY  
LOSE ELECTROLYTE.

### NOTICE

AVOID SERIOUS OUTBOARD ENGINE  
DAMAGE! USE ONLY FACTORY APPROVED  
PRODUCTS FOR OUTBOARD ENGINE AND  
DRIVE DURING STORAGE PERIODS.



### CAUTION

PREVENT STRUCTURAL HULL DAMAGE  
FROM BLOCKING HULL!  
NEVER BLOCK UP THE BOAT HULL.  
SUPPORT VESSEL ON CRADLE  
OR ADJUSTED TRAILER.  
STRUCTURAL HULL DAMAGE FROM  
BLOCKING IS NOT COVERED UNDER  
REGAL WARRANTY!



## Decommissioning Checklist

### Engine Winterization/Maintenance

- Run engine. Pour approved fuel stabilizer/conditioner in the fuel tank. Allow time for it to circulate through the fuel system.
- Change all engine fluids as referenced in the outboard engine manufacturer's owners manual. Contact a Regal dealer.
- Check engine hoses, clamps, and system wiring for loose connections, abrasion, and corrosion.
- Spray all exterior parts with a rust preventative.
- Perform maintenance as referenced in the engine manufacturer's owners manual. Contact your Regal dealer.
- Remove propeller. Refurbish as needed.

### Engine Care

- After cleaning use touch up paint on unit as needed.
- Apply coat of wax to engine drive.

### Boat

- Check hull bottom for any fiberglass damage.
- After cleaning apply a coat of wax to hull and deck surfaces.

- Pour a pint of 50/50 antifreeze into bilge pump.
- **Never block up boat bottom as structural damage may result which is not covered under Regal warranty.**



TYPICAL VESSEL LIFTED FROM WATER SUPPORTED BY LIFTING STRAPS

- Before attempting to lift the vessel using straps from a travel or stationary lift be sure to position slings correctly. **Use proper blocking and protection between the vessel and lifting straps.** Note if you are not sure of correct sling positions contact your closest authorized Regal dealer for additional information.

- Remove batteries. Use a trickle charger as needed.
- Remove all loose gear and electronics from boat. Inspect all equipment for wear and damage. Store in a clean, dry environment.
- Remove drain plug. Clean drain plug hole of debris as needed. Enclose drain plug in plastic bag and tie to steering wheel.
- Make sure bow is higher than stern to permit proper drainage.
- Clean all upholstery and store so it breathes.
- Conduct a visual inspection to ensure boat is balanced properly on the trailer, cradle or blocks.
- Cover boat with appropriate cover. Tie down for protection from rain, snow and/or wind. Prop up cover to provide proper ventilation. Do not cover up the fuel vents.
- Drain the fresh water system per instructions in this chapter.
- Use sling locations for lifting boat via Chapter 12 drawing.

#### Trailer

- Repack all wheel bearings per manufacturer's specifications.
- Check all trailer parts for excessive wear. Replace/ refurbish as needed.
- Use touch up paint on trailer as needed.

## Typical Fresh Water System

1. Activate the fresh water pump switch.
2. Open all faucets including transom shower (if equipped) and allow tank to empty.
3. Drain the water tank. Shut off fresh water pump switch.
4. Mix nontoxic antifreeze with water in accordance with the manufacturer's recommendations. (Available at marina & RV stores)
5. Pour solution into the fresh water tank.
6. Turn on fresh water pump switch.
7. Open water faucet and purge until a steady stream of nontoxic antifreeze flows from the faucet. If equipped, do the same to the transom shower. Turn the fresh water switch to the "off" position.

## Waste System

1. With chemical heads, make sure to dump both upper and lower tanks. Rinse well with fresh water. Sanitize chemical head as needed.
2. With electric head, pump out holding tank. Add nontoxic antifreeze to toilet and holding tank. Pump from toilet to holding tank to eliminate any water remaining in supply lines.

# NOTICE

AVOID VESSEL AND/OR OUTBOARD ENGINE DAMAGE! CONTACT A MARINE PROFESSIONAL FOR WINTERIZATION ASSISTANCE. DAMAGE CAUSED BY IMPROPER WINTERIZATION IS NOT COVERED BY REGAL OR OUTBOARD ENGINE MANUFACTURER.

## Recommissioning Checklist

### Engine

- Check all components per outboard engine manufacturer's owner's manual especially fluid levels.
- Run engine on "ear muffs" (flushette) before launching. Check for fuel, exhaust, oil, and water leaks.

### Boat

- Install drain plug.
- Install battery and tighten all terminals.
- Check all equipment, switches, alarms, gauges and breakers for proper operation.
- Add necessary chemicals and water to chemical head.
- Add water to fresh water tank. Turn on faucet to purge tank. Refill water tank.
- Make sure all safety gear is on board and in excellent working condition.
- Before attempting to lift any vessel using straps from a travel or stationary lift be sure to position slings correctly. ***Use proper blocking and protection between the vessel and lifting straps.*** Note if you are not sure of correct sling positions contact your closest authorized Regal dealer for additional information.

- After launching, check controls and gauges for proper operation.

### Trailer

- Make sure all equipment is in excellent working condition including lights, brake system, winch/cable, wheel bearings, wheels, and tires.



# Chapter 11

## Glossary & Index

Below is a brief list of nautical terminology. For more detailed glossaries we recommend you check your local library, book retailer, marine store or internet.

### Glossary

**Abeam:** at right angles to the fore and aft line and off the boat

**Aboard:** on or in the boat

**Above:**the part of the boat on a vessel which is above the interior of the boat

**Aft, After:** aft is the boat section toward the stern or back of the boat

**Amidships:** toward the center of the boat from either side to side or rear to front

**Beam:** the width of a boat at its widest part

**Bilge:** the lower interior of the hull of the boat

**Bitter end:** the end of a line also the end of an anchor line

**Bow:** the front, or forward part of the boat

**Bulkhead:** the vertical partition or wall of a boat

**Cast off:** to let go or release

**Chine:** the line fore and aft formed by the intersection of the side and bottom of the boat

**Chock:** deck fitting used to secure or guide anchor or tie lines

**Cleat:** deck fitting with protruding arms around which lines are secured

**Cockpit:** the seating space used to accommodate passengers

**Cuddy:** a small cabin in the fore part of the boat

**Deck:** the open flooring surface on which crew and passengers walk

**Draft:** the depth from the waterline of the boat to the lowest part of the boat, which indicates how much water is required to float the boat

**FasTrac-** a proven hull bottom design which incorporates a full, mid-beam step that reduces drag by forcing air under the hull to decrease drag and friction.

**Fathom:** a measurement of depth; one fathom equals six feet

**Fender:** a cushion hung from the side of a boat to prevent it from rubbing against a dock or against other boats.

Fend off: to push off to avoid sharp contact with dock or other vessel

Fore: the part of the boat toward the bow or front

Freeboard: the height of the top side from the waterline to the deck at its shortest point (The distance from sheer or gunwale to the water).

Gunwale: rail or upper edge of the side of the boat

Head: toilet

Hull: the part of the hull from the deck down

Keel: the lowest point of a boat; the backbone of the vessel

Knots: a measurement of speed indicating nautical miles per hour

Lee: the side opposite that from which the wind is blowing; the side sheltered from the wind

Leeward: the direction toward which the wind is blowing

PFD: personal flotation device; required for each person aboard

Port: the left side of the boat when facing forward (an easy way to remember the difference between "port" and "starboard" is that both "port" and "left" have four letters)

Shank: the main body of an anchor

Sheer: the curve of the boat's deck from fore to aft when seen from the side

Starboard: the right side of the boat when facing forward

Stern: the aft end of the boat

Stern drive: an inboard/outboard (I/O) unit

Stringer: strengthening integral unit fastened from fore to aft inside the hull and fiberglass encapsulated for added strength: much like the skeleton system of our body

## Index

### A

Accidents	39
Acrylics	269
Air Conditioning	121
All-Around Light	31
Anchor Light	31
Anchor Windlass	216
Anchoring	211
Audible Alarms	154
Automatic Fire Extinguisher	54
Autopilot	219

### B

Battery	61
	283
Battery Charger	81
Battery Switches	73
Bilge Pump	221
Boating Under The Influence	38
Bottom Blocking	309
Bow Thruster	222
Breaker Panel (DC)	67
Bridge Clearance	50
Buoys & Markers	48

### C

California EVAP Regulation	2
California Spark Ignition Warranty Info	2
Canvas	225
	270
Carbon Monoxide	35
Carbon Monoxide Detectors	148
Cardiopulmonary Resuscitation	214
Cockpit Sea Grass Mat	241
Controls (Helm)	163
	180

### D

Dealer Responsibilities	12
Decommissioning	310
Distress Signals	28
Diver's Flag	41
Docking	207
Door-Cabin Entrance	223
Door-Transom	261
Drainage Grates	224
Drain Plug	201

### E

EPIRB	11
Electrical System (DC)	57
Electrical System (AC)	94
Emergencies	213
Engine-Outboard Basics	171
Engine-Stern Drive Basics	151
Environmental Awareness	215
Exhaust	35

F		H	
Fender Clips	231	HIN (Hull Identification Number)	7
Fenders	205	Horn	34
Fiberglass	273	Hull Bottom	277
Filters-Air	122	Hypothermia	214
Filters-Gas/Diesel	114		
	120	I	
	162	Ignition Panel/Switch	164
	296		186
Fire Extinguishers	26	Index	316
First Aid	214	Interior Fabrics	272
Fishing	41	Interrupter Switch (Safety Lanyard)	190
FLIR camera	232		
Float Plan	9	K	
Fueling	202	Knots	213
Fuel System	114		
	120	L	
	128	Labels (Safety)	18
	286	Ladder	22
		Lighting	91
G		Life Raft	33
GFCI	105	Loading	20
Galvanic Corrosion	287		21
Galvanic Isolator	111	Law Of Salvage	212
Garbage Placard	33	Lubrication-Engine	158
Gathering Headway	206		178
Gelcoat Maintenance	273		
General Boating Safety	19	M	
Generator	115	Maneuvering	205
Getting Underway	201	Maintaining PFD'S	25
Glossary	314	Marpol Treaty	32
Grill	226	Masthead Light	32
		Metal Cleaning	278
		Minimum Required Equipment	34



N		S	
Navigational Aids	47	Safety Labels	18
Navigation Lights	31	Seacocks/Strainers	118
Navigation Rules	45		126
Neutral Safety Switch	168	SeaDek	240
	188	Seakeeper	242
Night Running	50	Seating	20
			233
			358
O			395
Oil Spills	32		
Overboard Discharge	146	Shallow Water Operation	210
Overloading	20	Shifting-Remote Control	168
	21		187
Owner's Information Packet	7	Shower	142
Owner's Registration	12	Shower Collection Box	144
Owner's Responsibilities	12	Signals-Navigation	44
		Smoke Alarm	55
		Sound Producing Devices	30
P		Spring Lines	204
Personal Flotation Devices	23	Stopping	207
Plastics	279	Stern Lines	203
Potable Water System	132	Stereo	244
Power Trim	208		292
	262		
Pre-departure questionnaire	201	Stove (Cooktop)	247
Propellers	176	Sunroof	251
	300	Sunshade	252
R			
Radar	238		
Radio Communications	30		
Recommissioning	313		
Refrigerator	229		
Required Safety Equipment	34		
Right Of Way	45		
Rules Of The Road	43		

T		Y	
Table Of Contents	5	Yacht Plate	7
Table	253		
Technical	320	Z	
Television	254	Zinc Anodes	290
Toilet	140		
Towing	212		
Trim Angle	208		
	210		
Trim Indicators	263		
Trim Tabs	262		
Troubleshooting	302		
U			
Underwater Lighting	264		
Upholstery	280		
V			
Vacuum Cleaner	265		
Ventilation	113		
Visual Distress Signals	29		
W			
Water Heater	138		
Water Tank (Potable) Filling	135		
	354		
Water Sports	41		
Warranty	14		
Waste System	145		
Weather	42		
Windshield Door Latch/Lock	267		
Windshield Wiper	267		
Winterizing	309		
Wiring Color Codes	58		

# Chapter 12

## Technical Info/Drawing Notes



### NOTICE

#### The Technical Chapter Features Three Sections:

1. Technical Information/Common Drawings (Grand Coupe & Outboard)
2. 36 Outboard Only Drawings (Vessel Hull Identification Number =VK (Stands For Model Designator)
3. 36 Grand Coupe Only Drawings (Vessel Hull Identification Number =VJ (Stands For Model Designator)

**NOTE AS PART OF REGAL'S COMMITMENT TO PRODUCT IMPROVEMENT SPECIFICATIONS, COMPONENTS , AND LOCATIONS DISPLAYED IN DRAWINGS AND/OR DOCUMENTATION MAY CHANGE AT ANY TIME. SELECT COMPONENTS ARE OPTIONAL.**

**NOTE TO READ SPECIFIC TITLE BOXES FOR DRAWING MODEL TYPE AND DESCRIPTION.**

**NOTE THAT INITIAL DRAWINGS WERE TITLED SC. THE VESSEL NAME IS NOW DESIGNATED AS THE GRAND COUPE.**

**TECHNICAL INFORMATION/  
COMMON DRAWINGS  
(GRAND COUPE & OUTBOARD)**

*NOTE AS PART OF REGAL'S COMMITMENT TO PRODUCT IMPROVEMENT SPECIFICATIONS, COMPONENTS, AND LOCATIONS DISPLAYED IN DRAWINGS AND/OR DOCUMENTATION MAY CHANGE AT ANY TIME. SELECT COMPONENTS ARE OPTIONAL AND MAY NOT BE INSTALLED ON YOUR VESSEL.*

*NOTE TO READ SPECIFIC TITLE BOXES FOR DRAWING MODEL TYPE AND DESCRIPTION. MODEL SPECIFIC INFORMATION ON INDIVIDUAL DRAWINGS IS NOTED BY AN \* SYSTEM. SELECT COMPONENTS ARE OPTIONAL.*

# TYPICAL DOMESTIC (EPA) COMPLIANT GASOLINE FUEL SYSTEM COMPONENTS

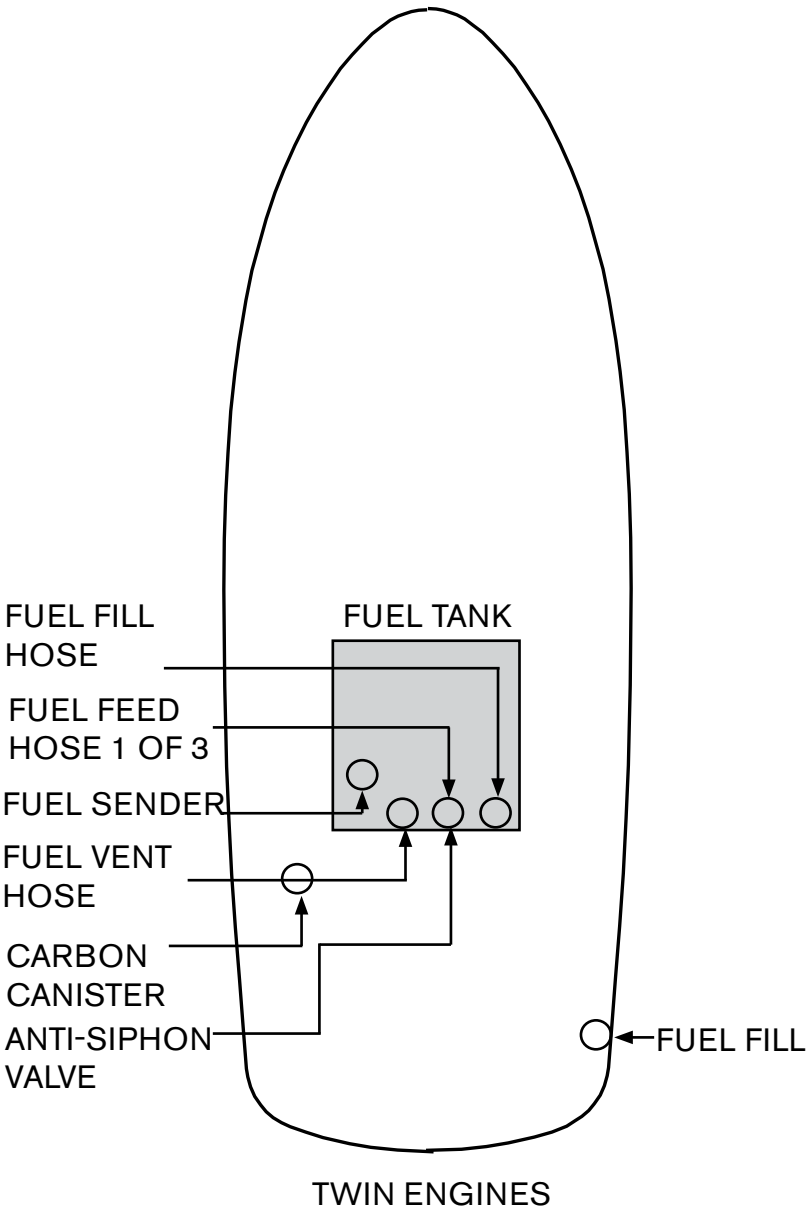

**\* NOTE THAT ABOVE PETRO TANKS FEATURE 2 ENGINE FUEL FEEDS & 1 GENERATOR FEED**  
**\*\* FOR DIESEL GENERATOR OPTION A SEPARATE FUEL TANK IS PROVIDED**



# TYPICAL LABELS & LOCATIONS

**WARNING**  
USE PROPER BLOCKING TECHNIQUES  
WHEN LIFTING BOAT

**NOTICE**  
**Retrieval of Windlass Chain**  
Winch operator may be required to periodically spread chain out within anchor locker



**CAUTION**  
TO AVOID INJURY WINDSHIELD DOOR  
MUST BE SECURELY LATCHED  
IN EITHER OPEN OR CLOSE POSITION  
WHEN BOAT IS UNDERWAY!



**WARNING**  
AVOID SERIOUS INJURY OR DEATH  
FROM FIRE OR EXPLOSION  
RESULTING FROM LEAKING FUEL.  
INSPECT SYSTEM FOR LEAKS AT  
LEAST ONCE A YEAR.

**WARNING**  
Electrical shock and fire hazard. Failure to follow these instructions may result in injury or death.  
(1) Turn off the boat's shore power connection switch before connecting or disconnecting the shore power cable.  
(2) Connect the shore power cable to the boat first.  
(3) If polarity-warning indicator is activated, immediately disconnect cable.  
(4) Disconnect shore power cable at shore outlet first.  
(5) Close shore power inlet cover tightly.  
**DO NOT ALTER SHORE POWER CABLE CONNECTORS**

**WARNING**  
ROTATING PROPELLER(S) MAY CAUSE  
SERIOUS INJURY OR DEATH!  
DO NOT APPROACH OR USE LADDER  
WHEN ENGINE IS RUNNING.

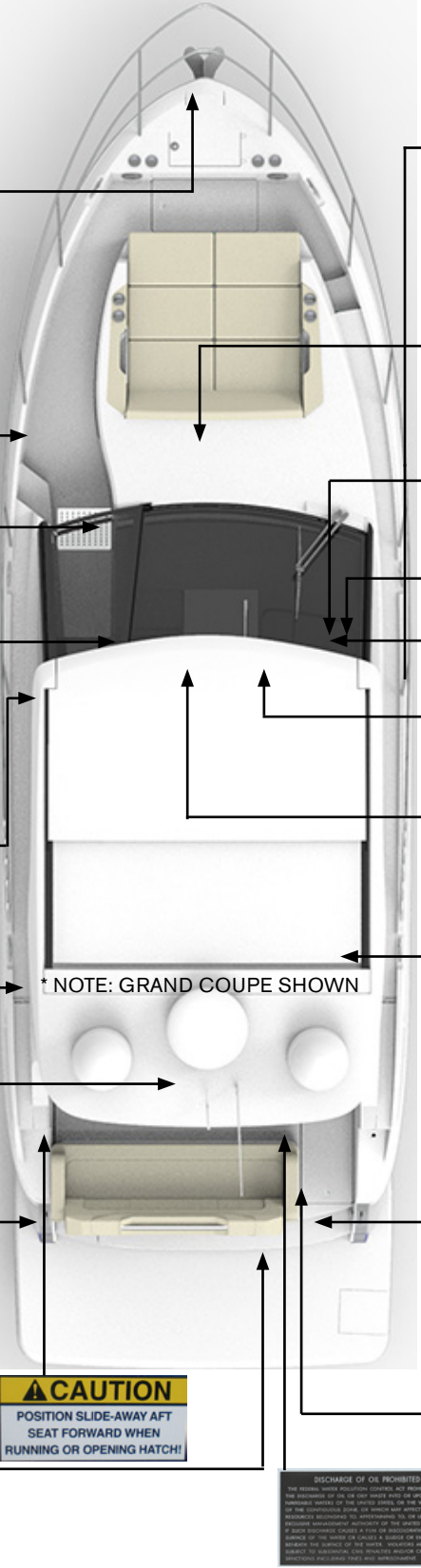

**WARNING**  
ROTATING PROPELLER(S) MAY CAUSE  
SERIOUS INJURY OR DEATH!  
DO NOT APPROACH OR USE LADDER  
WHEN ENGINE IS RUNNING.

**WARNING**  
Carbon monoxide (CO) can cause brain damage or death.  
Engine and generator exhaust contains odorless and colorless carbon monoxide gas. Signs of carbon monoxide poisoning include nausea, headache, dizziness, drowsiness, and lack of consciousness.  
Get fresh air if anyone shows signs of carbon monoxide poisoning.  
See Owner's Manual for information regarding carbon monoxide poisoning.

**WARNING**  
PREVENT INJURY OR DEATH  
DUE TO FIRE OR EXPLOSION!  
RUN BLOWER AT LEAST 4  
MINUTES BEFORE STARTING ENGINE.

MEETS U.S. EPA EVAP  
STANDARDS USING  
CERTIFIED COMPONENTS  
REGAL MARINE INC., ORLANDO, FL

**WARNING**  
AVOID PERSONAL INJURY!  
INTERRUPT SWITCH MUST BE ATTACHED TO OPERATOR  
WHILE ENGINE IS RUNNING. QUALIFIED OPERATOR MUST  
BE IN CONTROL AT ALL TIMES.  
READ OWNER'S MANUAL BEFORE USE.

**WARNING**  
CARBON MONOXIDE IS A TASTELESS, ODORLESS, AND  
INVISIBLE GAS THAT CAN CAUSE DISCOMFORT, SEVERE  
AND EVEN DEATH. EXERCISE CAUTION WHILE OPERATING  
A GENERATOR OR ENGINE IN CONFINED SPACES OR AT  
DOCK SIDE. DO NOT ALLOW HULL EXHAUST OUTLETS TO  
BECOME BLOCKED OR EXHAUST FUMES CAN BECOME  
TRAPPED IN OR AROUND THE CONFINES OF YOUR VESSEL.

\* NOTE: GRAND COUPE SHOWN

THE DISCHARGE OF ALL FORMS OF PLASTIC INTO ALL WATERS IS PROHIBITED

THE DISCHARGE OF ALL GARBAGE IS PROHIBITED  
into the navigable waters of the United States, and into all other waters except as specifically allowed.

**ALLOWED:** 3 to 12 nautical miles from land – Food waste ground to pass through a one-inch mesh screen.  
**ALLOWED:** 12 or more nautical miles from land – Food waste ground as above, and waste water, and cleaning agents, en route as far from shore as practicable, that are not harmful to the marine environment.

**MARPOL ANNEX V – SPECIAL AREAS**  
**GULF OF MEXICO & CARIBBEAN SEA** – Food waste en route ground to pass through a one-inch mesh screen.  
**WESTERN CARIBBEAN REGION** – Discharge of all garbage prohibited within 12 nautical miles of land.

Any person who violates the above requirements is liable for civil and/or criminal penalties and regional, state and local restrictions on garbage discharges may also apply.

REPORT ILLEGAL DISPOSAL TO THE U.S. COAST GUARD ON VHF RADIO CHANNEL 16

**DANGER**  
Carbon monoxide (CO) can cause brain damage or death.  
Engine and generator exhaust contains odorless and colorless carbon monoxide gas. Carbon monoxide will be around the back of the boat when engines or generators are running.  
Move to fresh air, if you feel nausea, headache, dizziness, or drowsiness.

**CAUTION**  
POSITION SLIDE-AWAY AFT  
SEAT FORWARD WHEN  
RUNNING OR OPENING HATCH!

**WARNING**  
TRANSOM DOOR MUST BE CLOSED  
AND SECURED WHEN ENGINE IS RUNNING

DISCHARGE OF OIL PROHIBITED  
The discharge of oil into navigable waters, or into any other waters, is prohibited. This prohibition applies to all oil, including but not limited to, motor oil, hydraulic oil, gear oil, transmission oil, and other petroleum-based oils. This prohibition also applies to oil-based paint, varnish, and other oil-based coatings. This prohibition does not apply to the discharge of oil from a boat that is being used for research or other purposes. For more information, see the owner's manual.

\* NOTE: LABEL LOCATION AND DESCRIPTION MAY CHANGE.

# SLING LOCATION DIMENSIONS

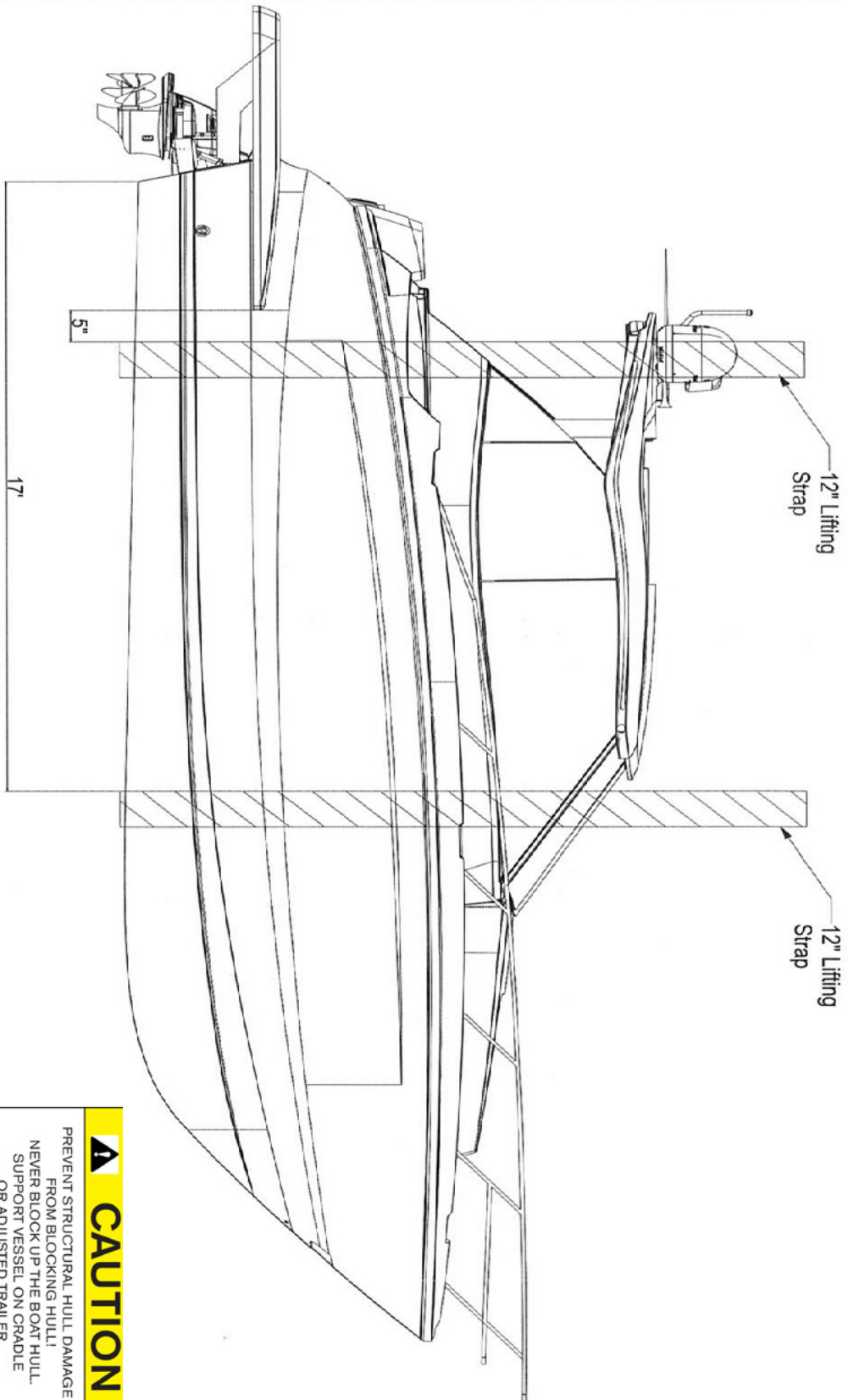

\* NOTE: STERN DRIVE MODEL SHOWN.

## REFERENCE ONLY

REGAL MARINE INDUSTRIES AND CO., INC. MAKES NO WARRANTY AND ASSUMES NO LIABILITY FOR THE USE OF THIS INFORMATION IN ANY MANNER. REGAL MARINE INDUSTRIES AND CO., INC. MAKES NO WARRANTY AND ASSUMES NO LIABILITY FOR THE USE OF THIS INFORMATION IN ANY MANNER. REGAL MARINE INDUSTRIES AND CO., INC. MAKES NO WARRANTY AND ASSUMES NO LIABILITY FOR THE USE OF THIS INFORMATION IN ANY MANNER.

## **CAUTION**

PREVENT STRUCTURAL HULL DAMAGE FROM BLOCKING HULL! NEVER BLOCK UP THE BOAT HULL. SUPPORT VESSEL ON CRADLE OR ADJUSTED TRAILER. STRUCTURAL HULL DAMAGE FROM BLOCKING IS NOT COVERED UNDER REGAL WARRANTY!

REGAL MARINE INDUSTRIES  
2000 W. STATE ST.  
DENVER, CO 80202  
TEL: (303) 733-1989

### 36 GC/XO Sling Locations

DATE	04/22/2020	VERSION	1 OF 2
DESIGNED BY	DMC	APPROVED BY	MWJ25F

# BATTERY MANAGEMENT SYSTEM-OVERVIEW

Subject Work Instruction: 36 V/1V/K Battery Management Assembly	Issue Date: 02/26/2020	Rev.: 0	Document No. WI-1638
Approved By: Mark Journey	Written By: Kyle Quatman	Rev Date: ....	Page: 6 of 11

[ REFERENCE ONLY ]

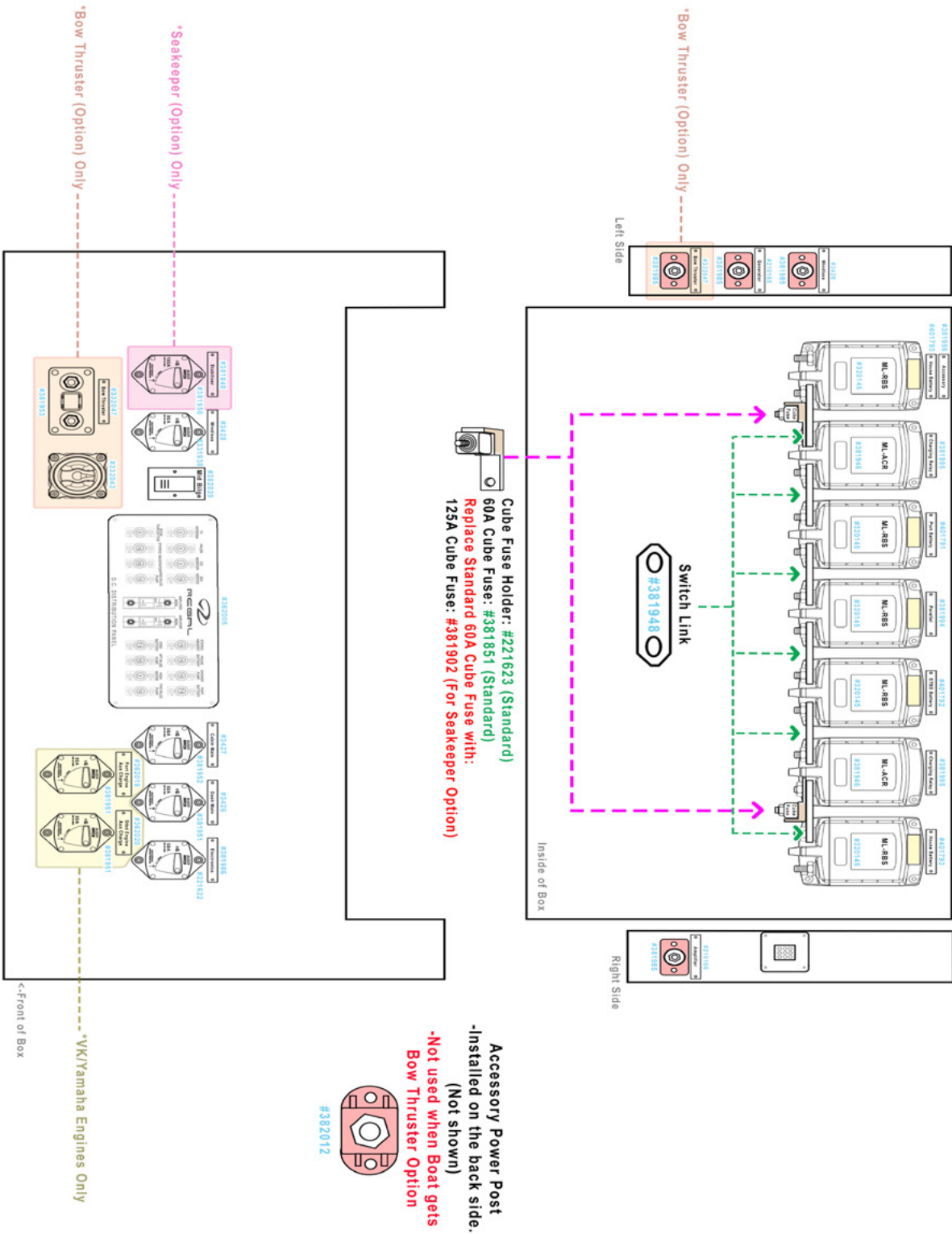

# BATTERY MANAGEMENT SYSTEM PANEL OPEN VIEW

Subject Work Instruction:	Issue Date:	Rev:	Document No.
36 V/1K Battery Management Assembly	02/26/2020	0	WI-1638
Approved By:	Written By:	Rev Date:	Page:
Mark Journey	Kyle Quatman	....	7 of 11

[ REFERENCE ONLY ]

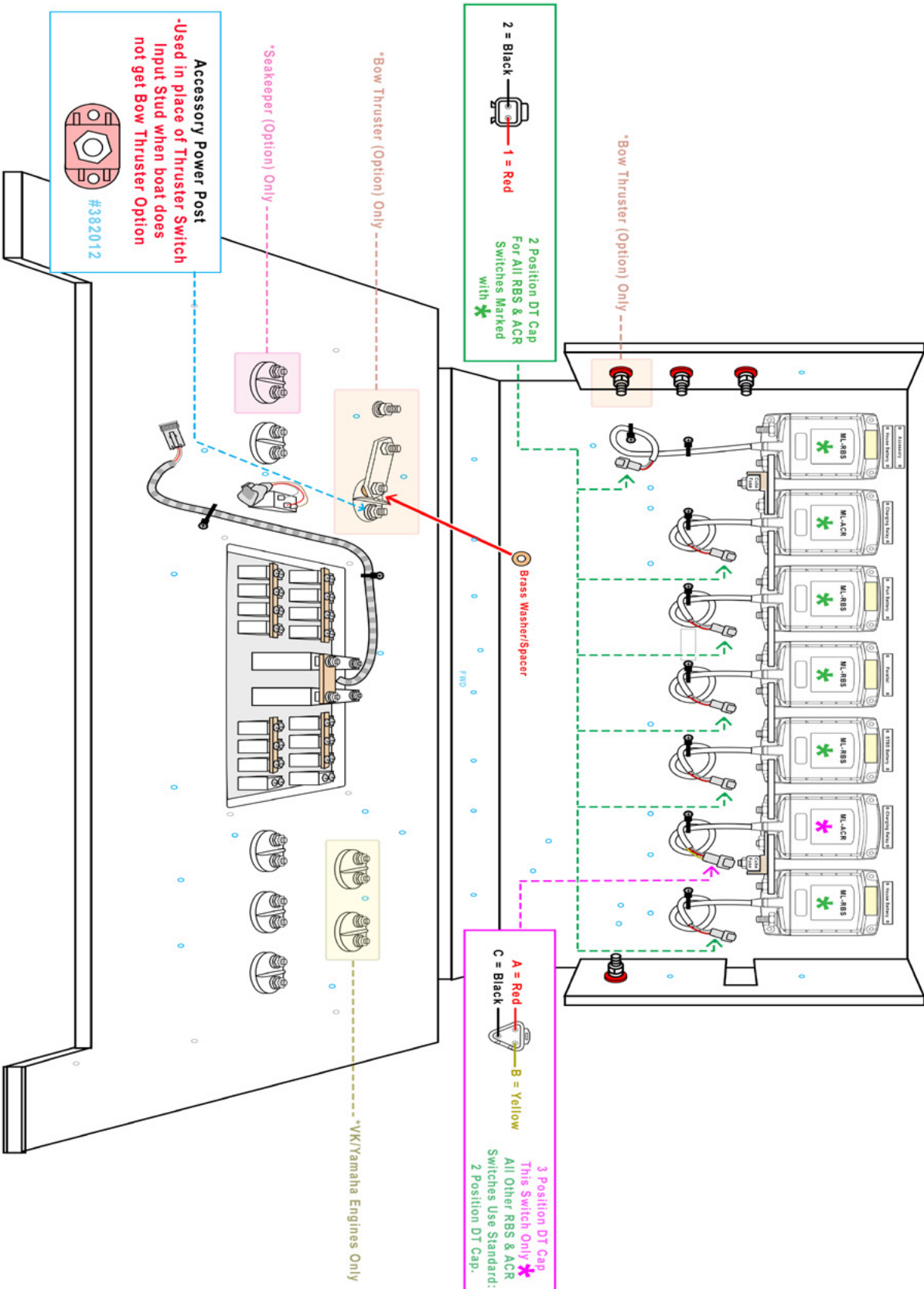



# BATTERY MANAGEMENT SYSTEM-CABLE RUN #1

Subject Work Instruction: 36 VJVK Battery Management Assembly	Issue Date: 02/26/2020	Rev: 0	Document No. WI-1638
Approved By: Mark Journey	Written By: Kyle Quatman	Rev Date: ....	Page: 8 of 11

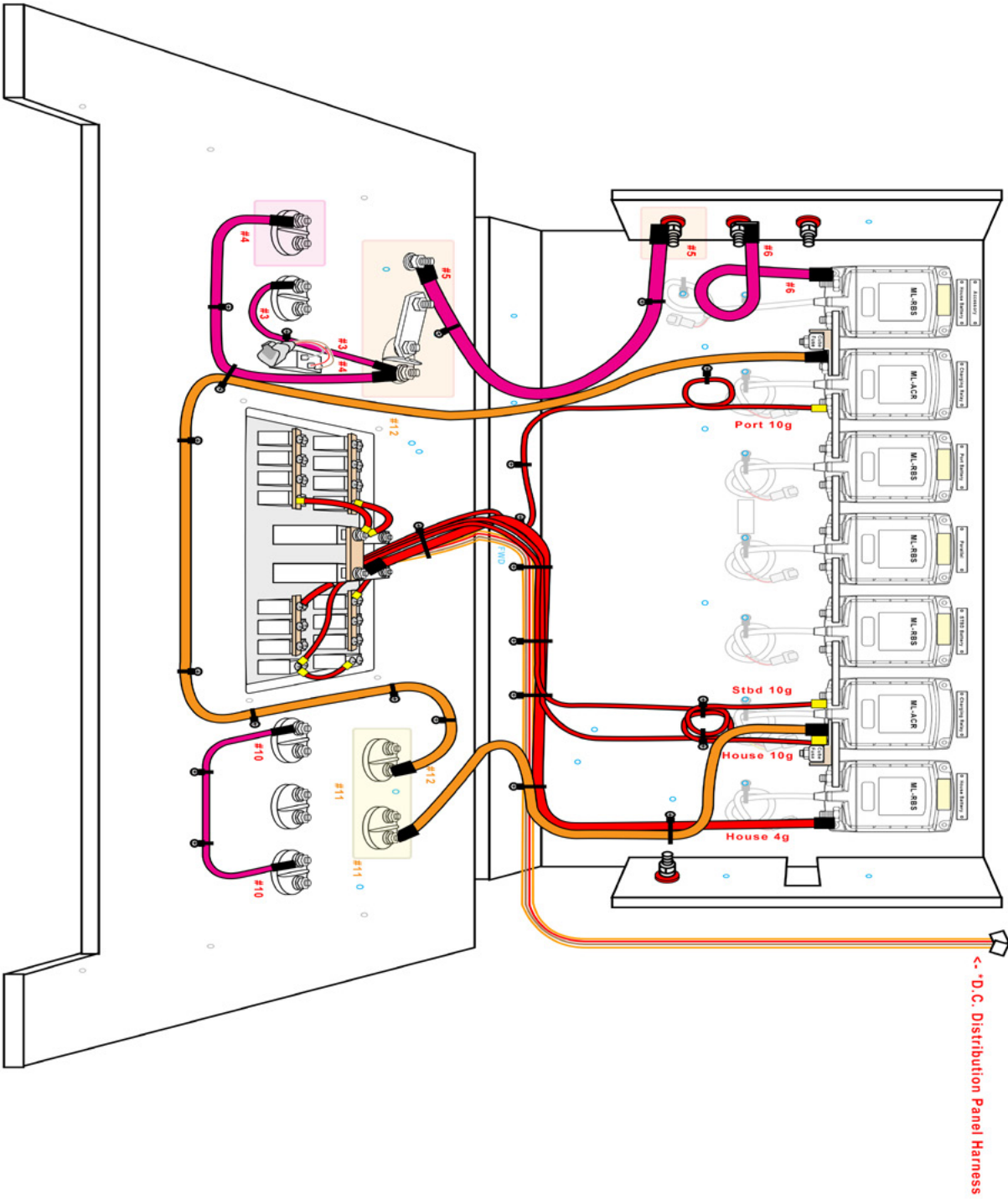

[ REFERENCE ONLY ]



# BATTERY MANAGEMENT SYSTEM-CABLE RUN #2

Subject Work Instruction: 36 VJVK Battery Management Assembly	Issue Date: 02/26/2020	Rev.: 0	Document No.: WI-1638
Approved By: Mark Journey	Written By: Kyle Quatman	Rev Date: ....	Page: 9 of 11

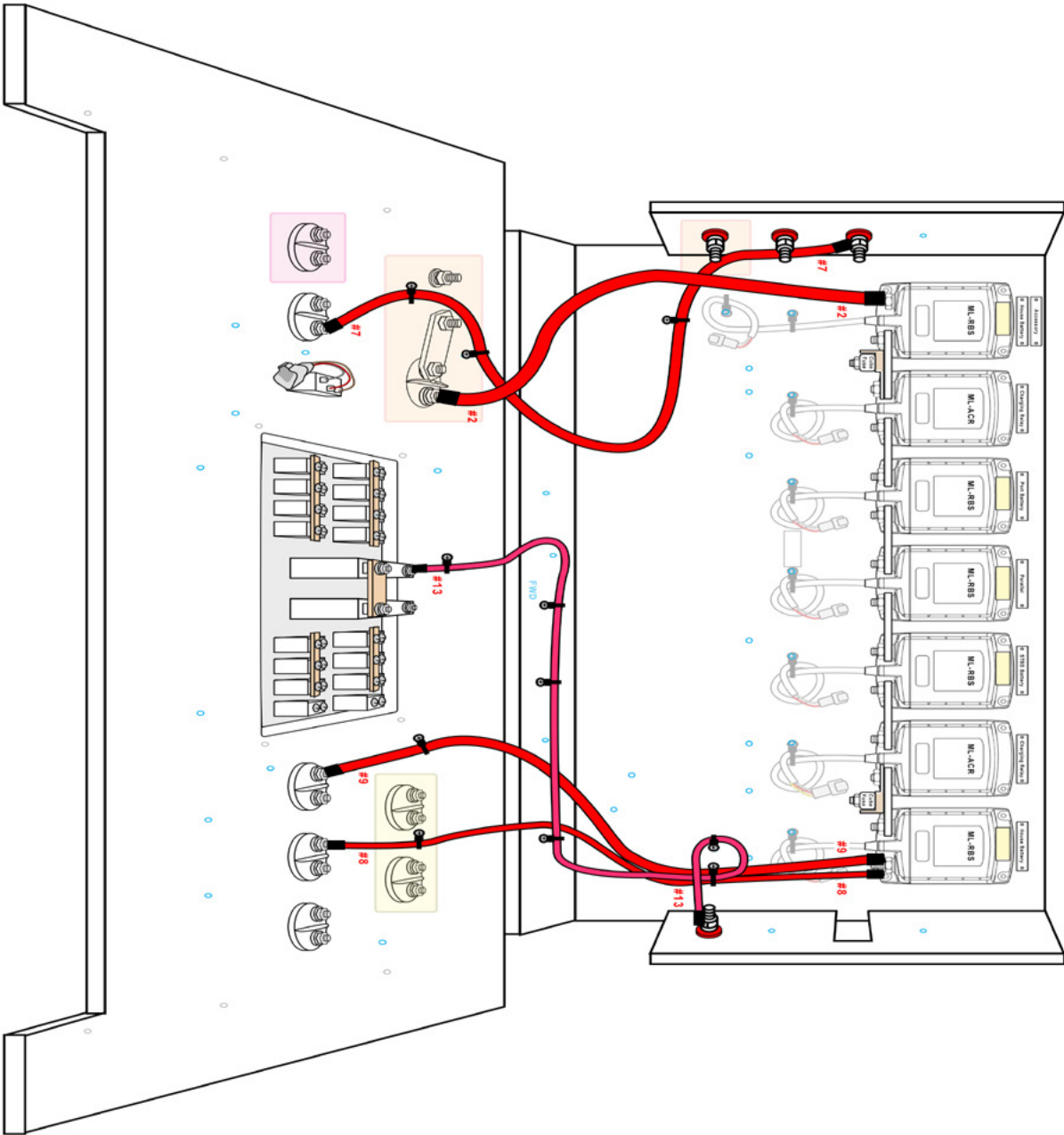

# BATTERY MANAGEMENT SYSTEM-CABLE RUN #3

Subject Work Instruction: 36 VJVK Battery Management Assembly	Issue Date: 02/26/2020	Rev.: 0	Document No.: WI-1638
Approved By: Mark Journey	Written By: Kyle Quatman	Rev. Date: ....	Page: 10 of 11

[ REFERENCE ONLY ]

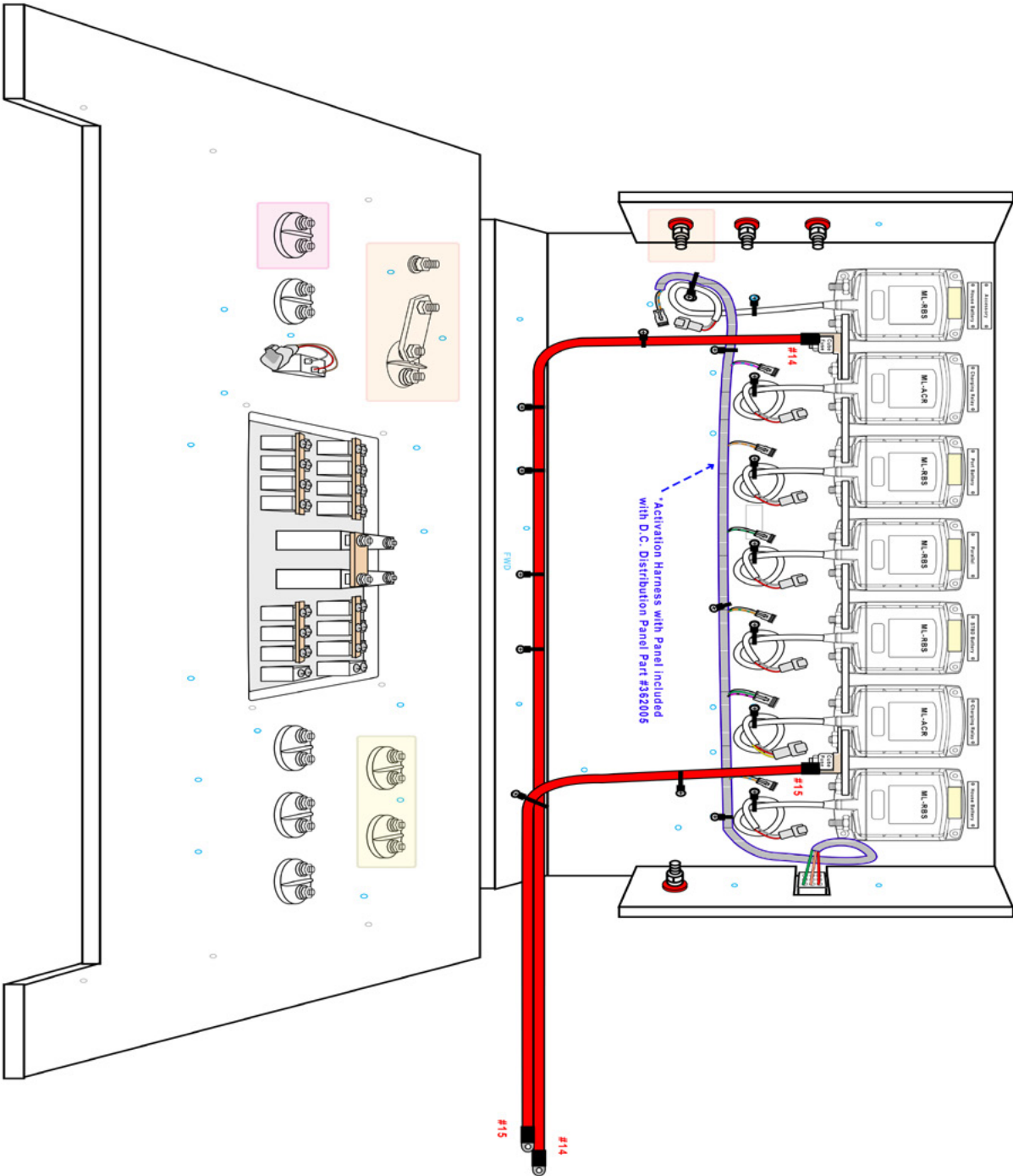

# BATTERY MANAGEMENT SYSTEM-FINAL CONNECTIONS

Subject Work Instruction:	Issue Date:	Rev:	Document No.
36 V/1K Battery Management Assembly	02/26/2020	0	WI-1638
Approved By:	Written By:	Rev Date:	Page:
Mark Journey	Kyle Quatman	....	11 of 11

[ REFERENCE ONLY ]

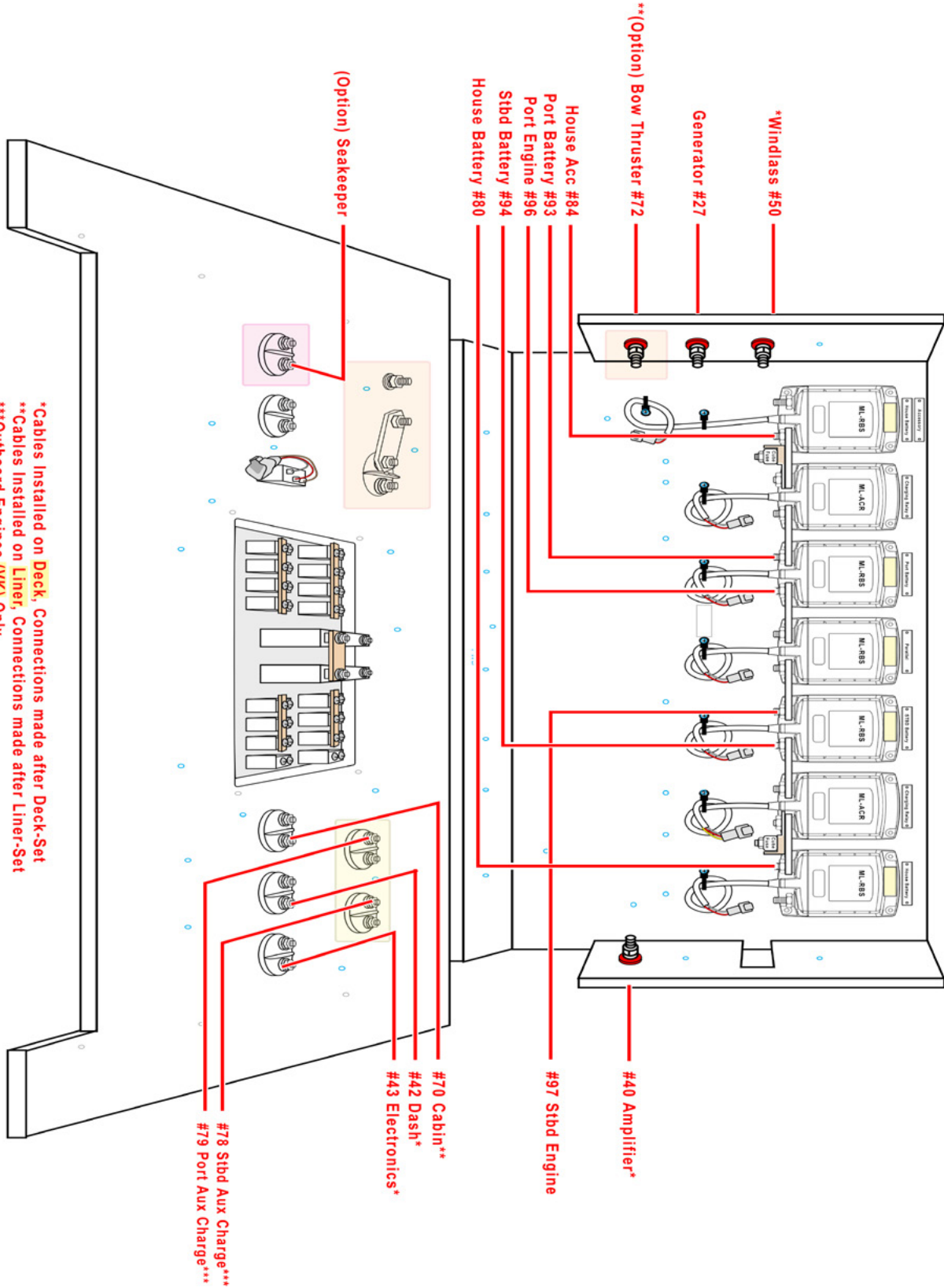

\*Cables Installed on Deck, Connections made after Deck-Set  
 \*\*Cables Installed on Liner, Connections made after Liner-Set  
 \*\*\*Outboard Engines (VK) Only

# AMPLIFIER RCA WIRING/SETTINGS

Subject Work Instruction: VJ/VK 36 Amplifier Wiring/Settings	Issue Date: 03/11/2020	Rev: 0	Document No. WI-1637
Approved By: Mark Journey	Written By: Mark Journey Kyle Quatman	Rev Date: ----	Page: 2 of 3

[ REFERENCE ONLY ]

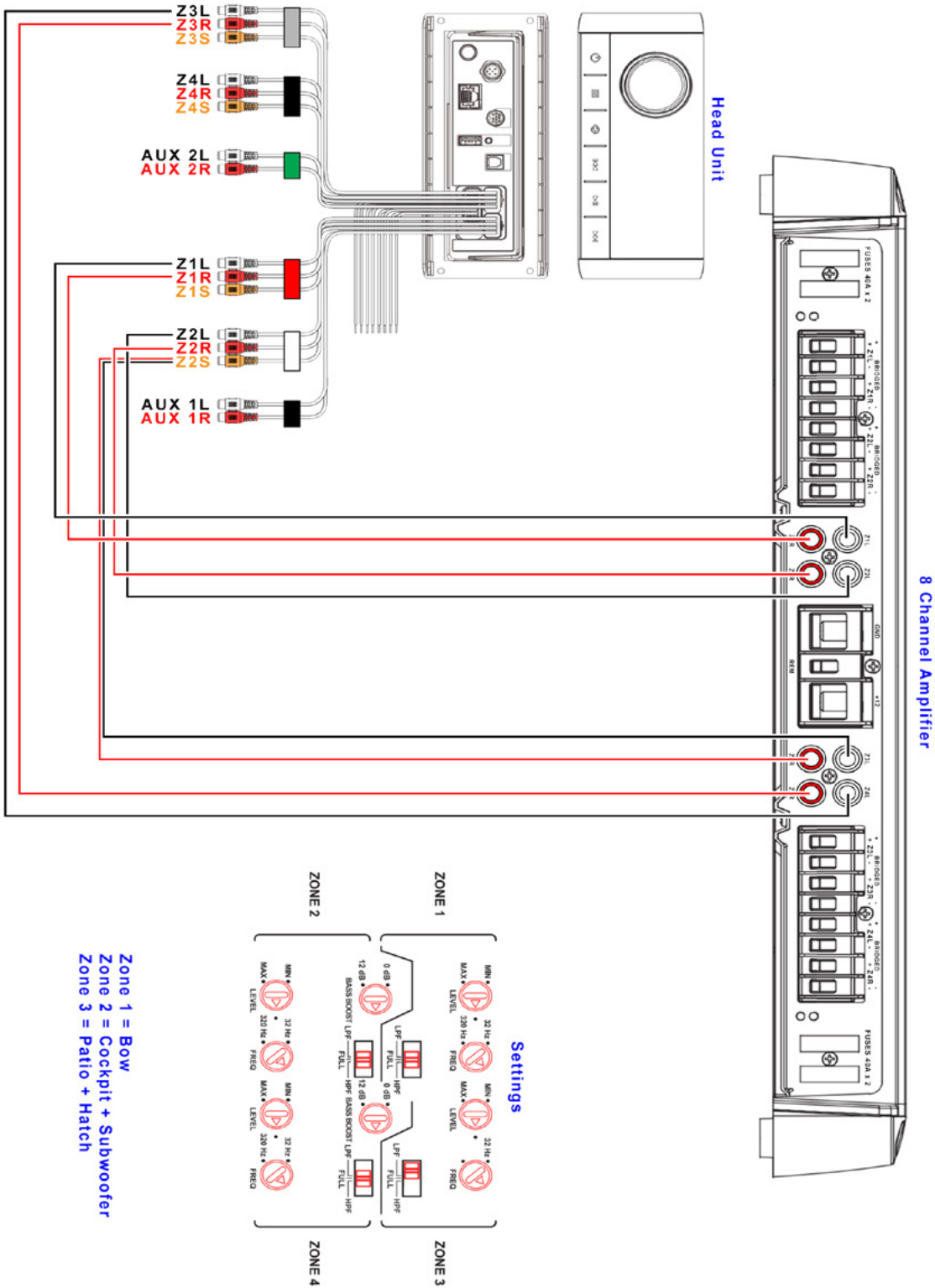

# AMPLIFIER WIRING/SPEAKERS

Subject Work Instruction:	Issue Date:	Rev:	Document No.
VJ/VK 36 Amplifier Wiring/Settings	03/04/2020	0	WI-1637
Approved By:	Written By:	Rev Date:	Page:
Mark Journey	Mark Journey Kyle Quatman	----	3 of 3

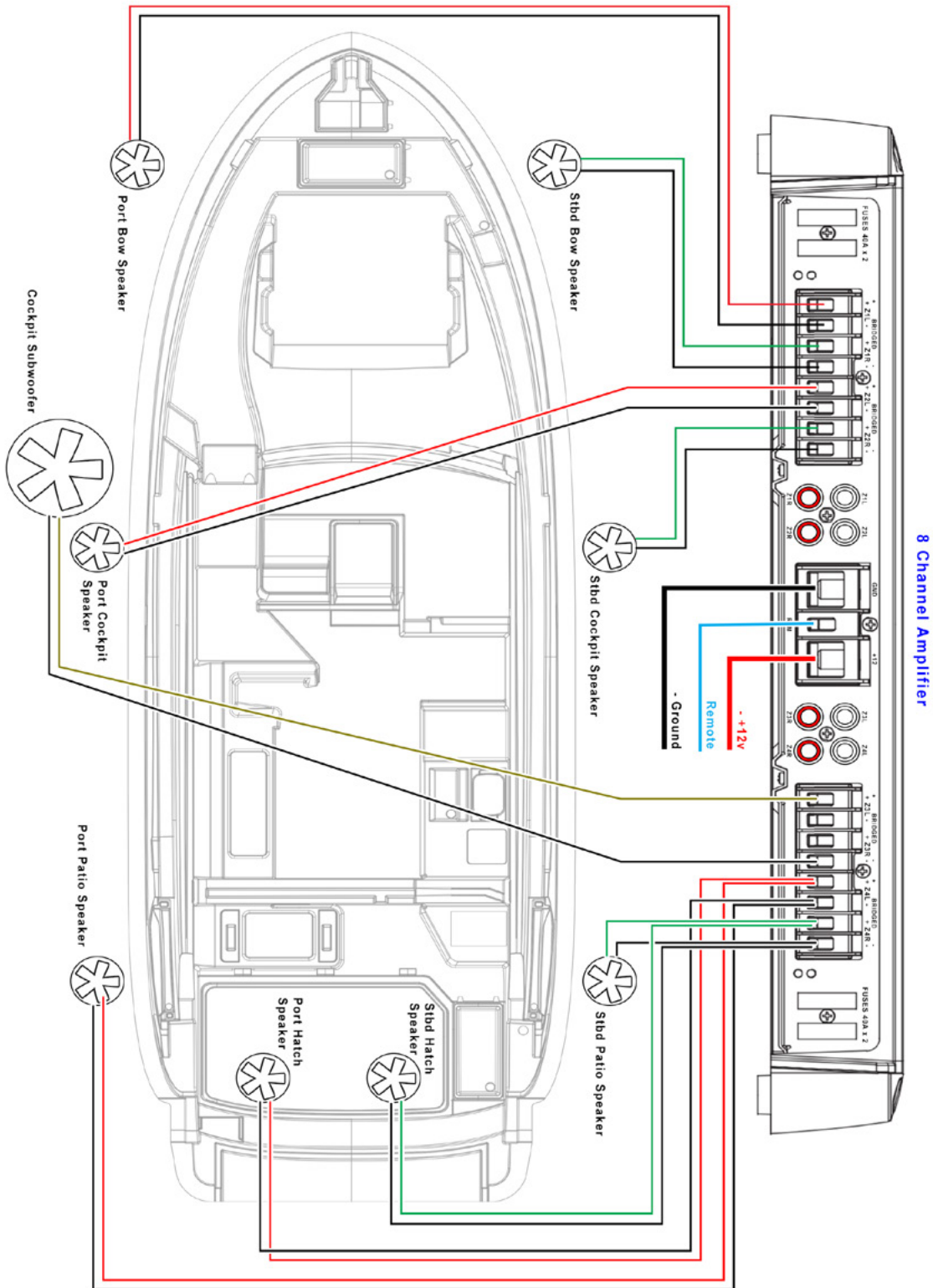

[ REFERENCE ONLY ]



# CABIN & HEAD LIGHTING

Subject Work Instruction: VJ/VK Cabin/Head Lighting	Issue Date: 04/24/2020	Rev.: 0	Document No.: EL-138
Approved By: Dion Colbourne	Written By: Kyle Quatman	Rev Date: ....	Page: 1 of 1

[ REFERENCE ONLY ]

## Head Switches

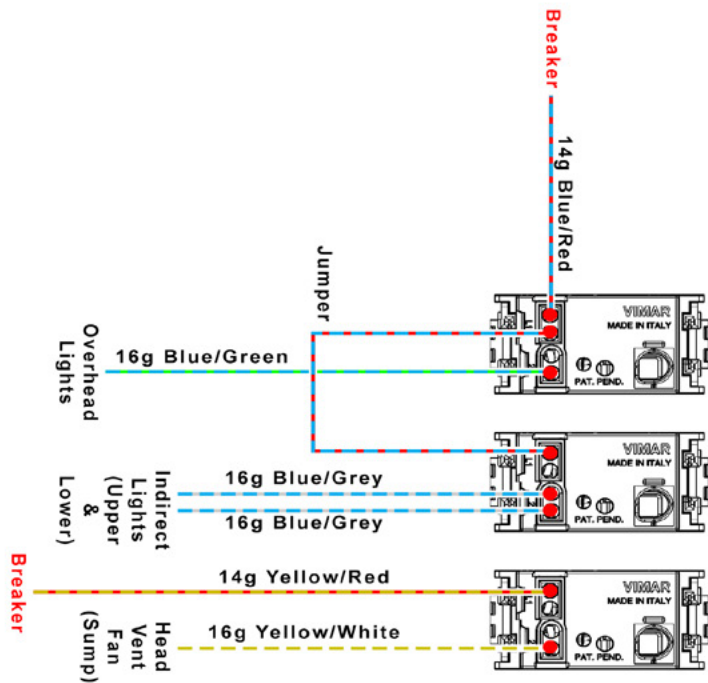

## Mid-Berth Lights

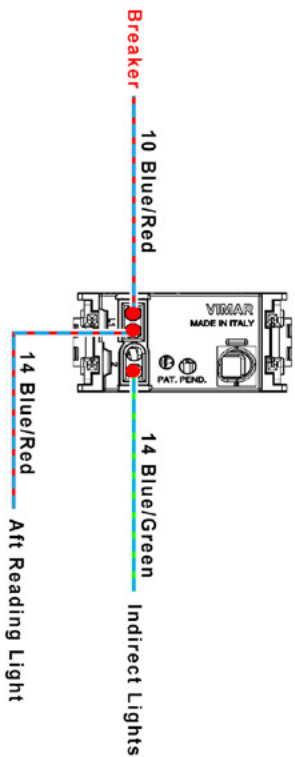

## FWD Cabin Lighting Switches

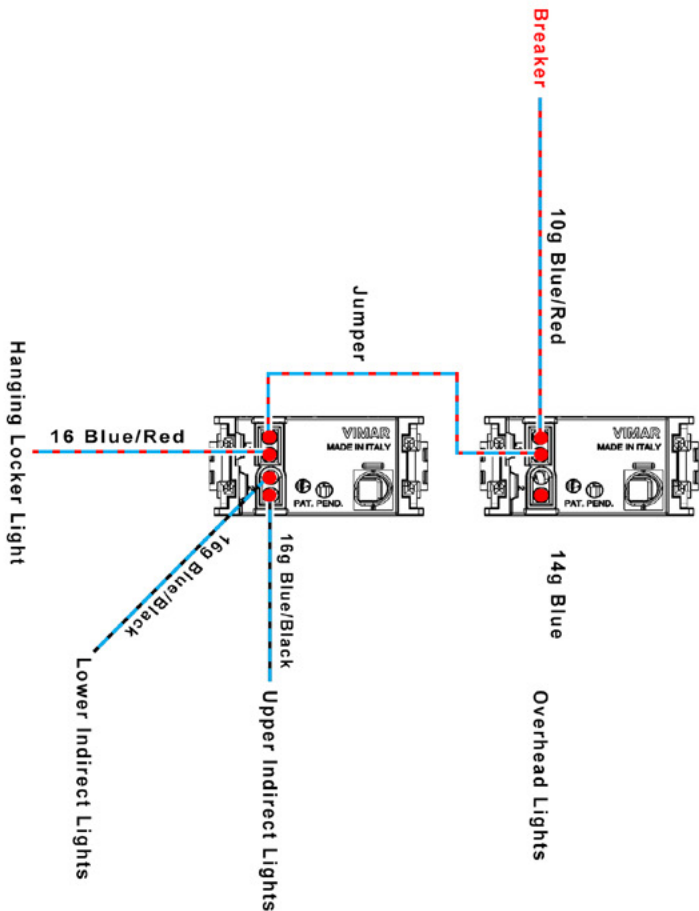

# SUB HARNESS ROUTINGS-LIGHTING

Subject Work Instruction: VJ/VK Liner Cap Lighting Harnesses	Issue Date: 03/20/2020	Rev: 0	Document No. EI-124
Approved By: Dion Colbourne	Written By: Kyle Quatman	Rev Date: ....	Page: 1 of 1

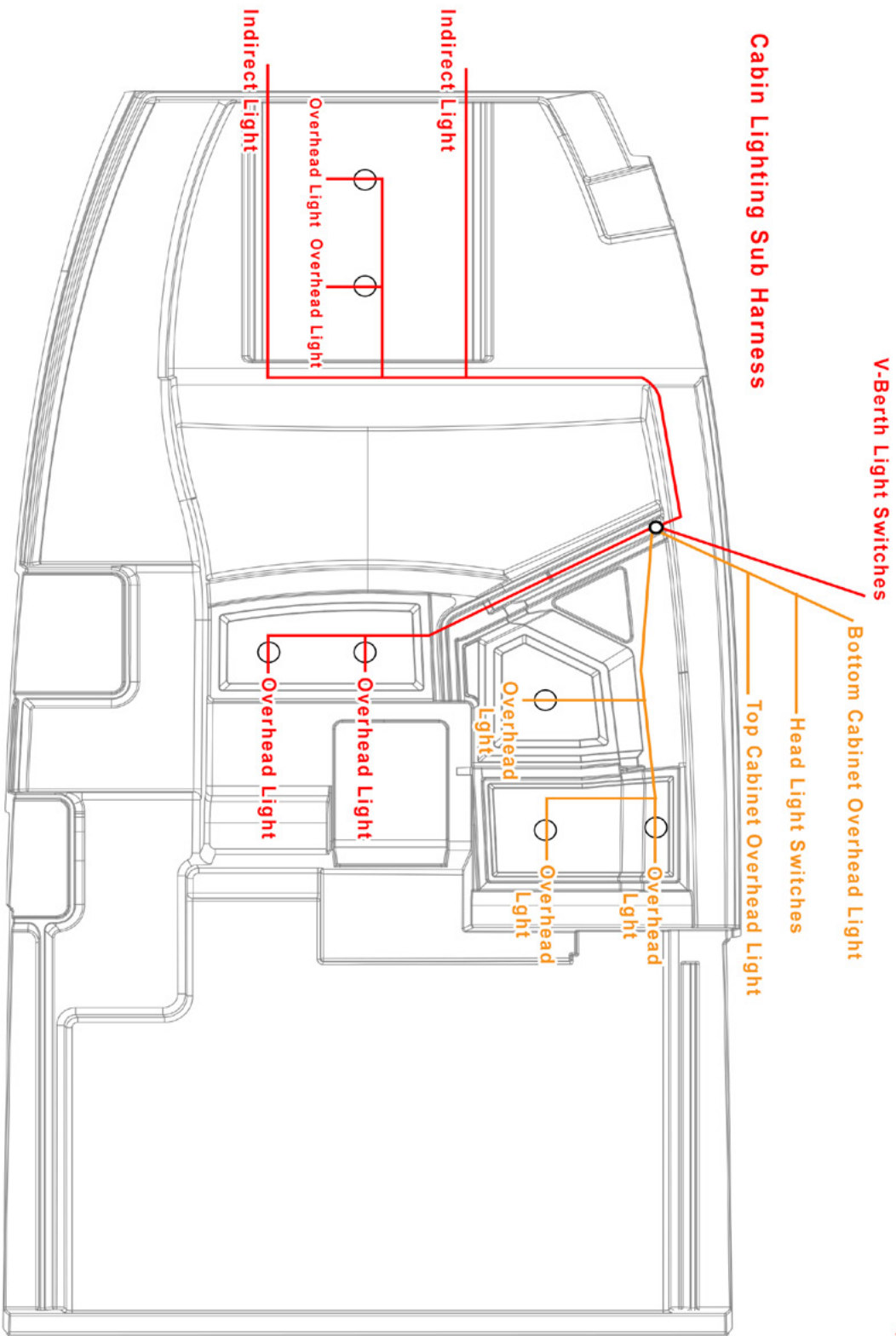

[ REFERENCE ONLY ]

# HARNESS ROUTINGS-FORWARD DECK/BILGE LIGHTING

Subject Work Instruction: VJ/VK Harness Routings Fwd Deck + Bilge Lighting Sub	Issue Date: 03/20/2020	Rev: 0	Document No. EL-102
Approved By: Dion Colbourne	Written By: Kyle Quatman	Rev Date: ....	Page: 1 of 1

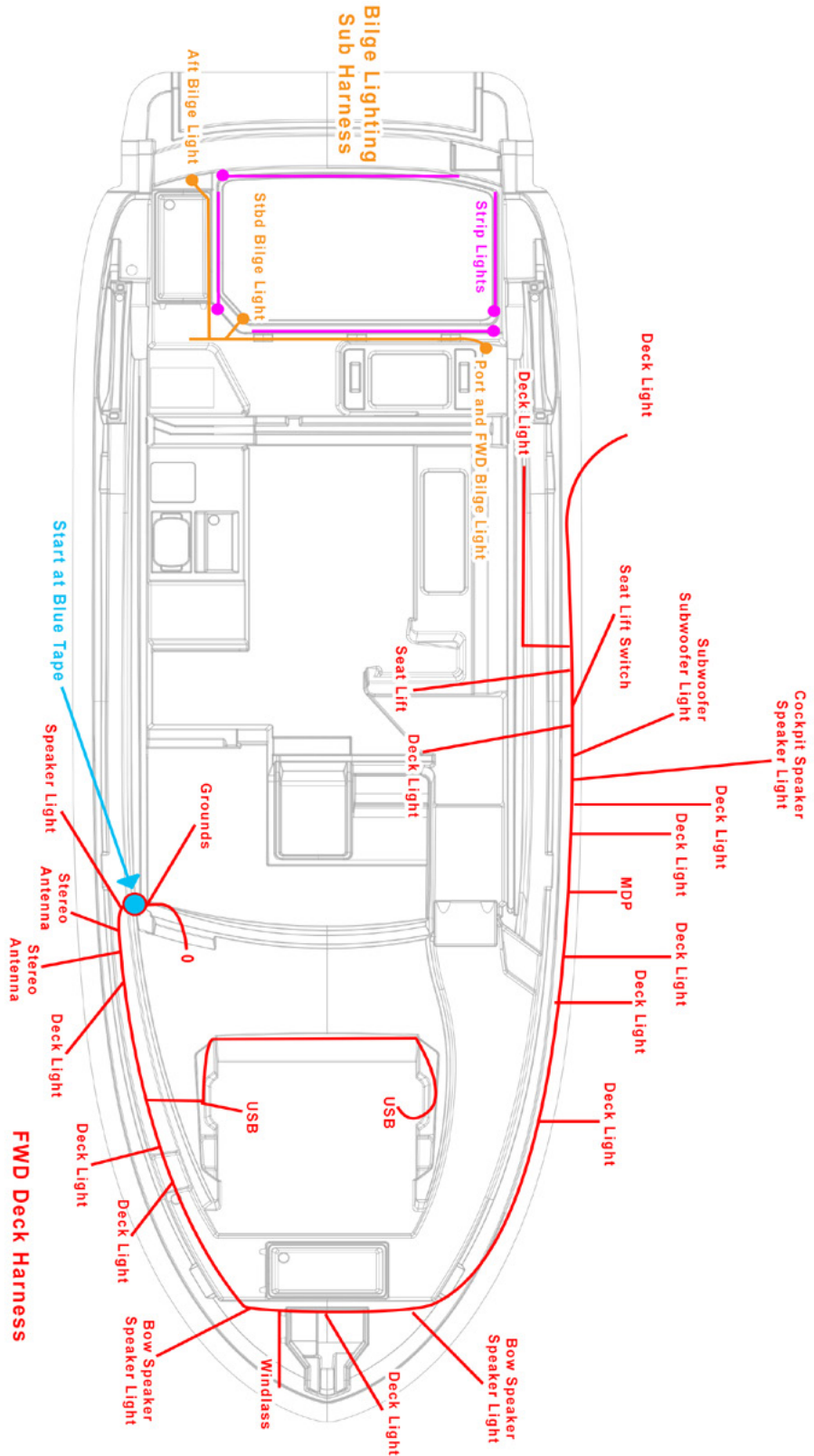

[ REFERENCE ONLY ]

# HARNES ROUTINGS-HARD TOP COMPONENTS/LIGHTING

Subject Work Instruction: 36 VJ/VK Hard Top Harness Routing	Issue Date: 04/24/2020	Rev: 0	Document No. EL-123
Approved By: Dion Colbourne	Written By: Kyle Quatman	Rev Date: ----	Page: 1 of 1

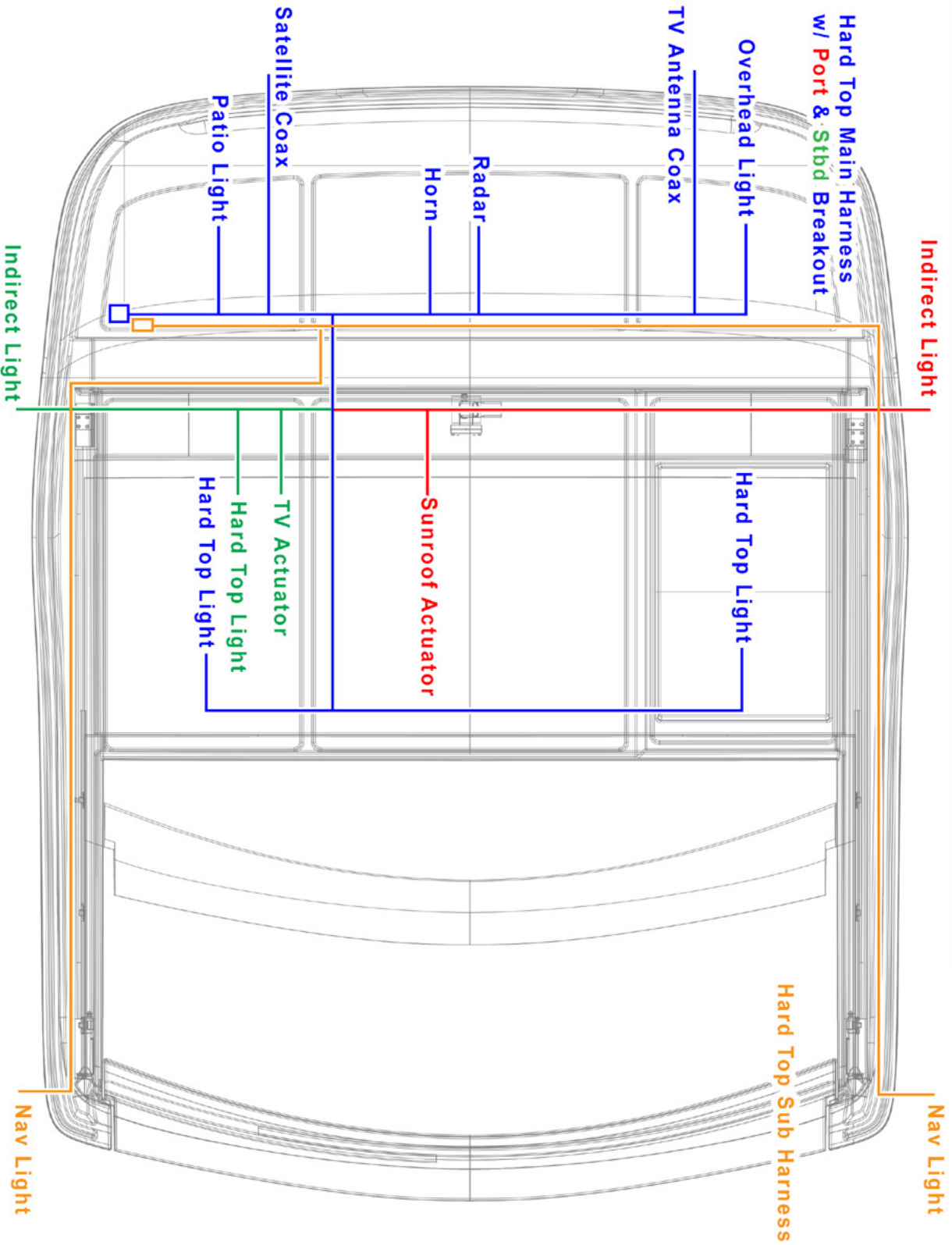

[ REFERENCE ONLY ]

# HARNESSE ROUTINGS-AFT DECK

Subject Work Instruction:	Issue Date:	Rev:	Document No.
V/J/K Harness Routings Aft Deck	03/20/2020	0	EL-101
Approved By:	Written By:	Rev Date:	Page:
Dion Colbourne	Kyle Quatman	....	1 of 1

[ REFERENCE ONLY ]

## AFT DECK HARNESSE

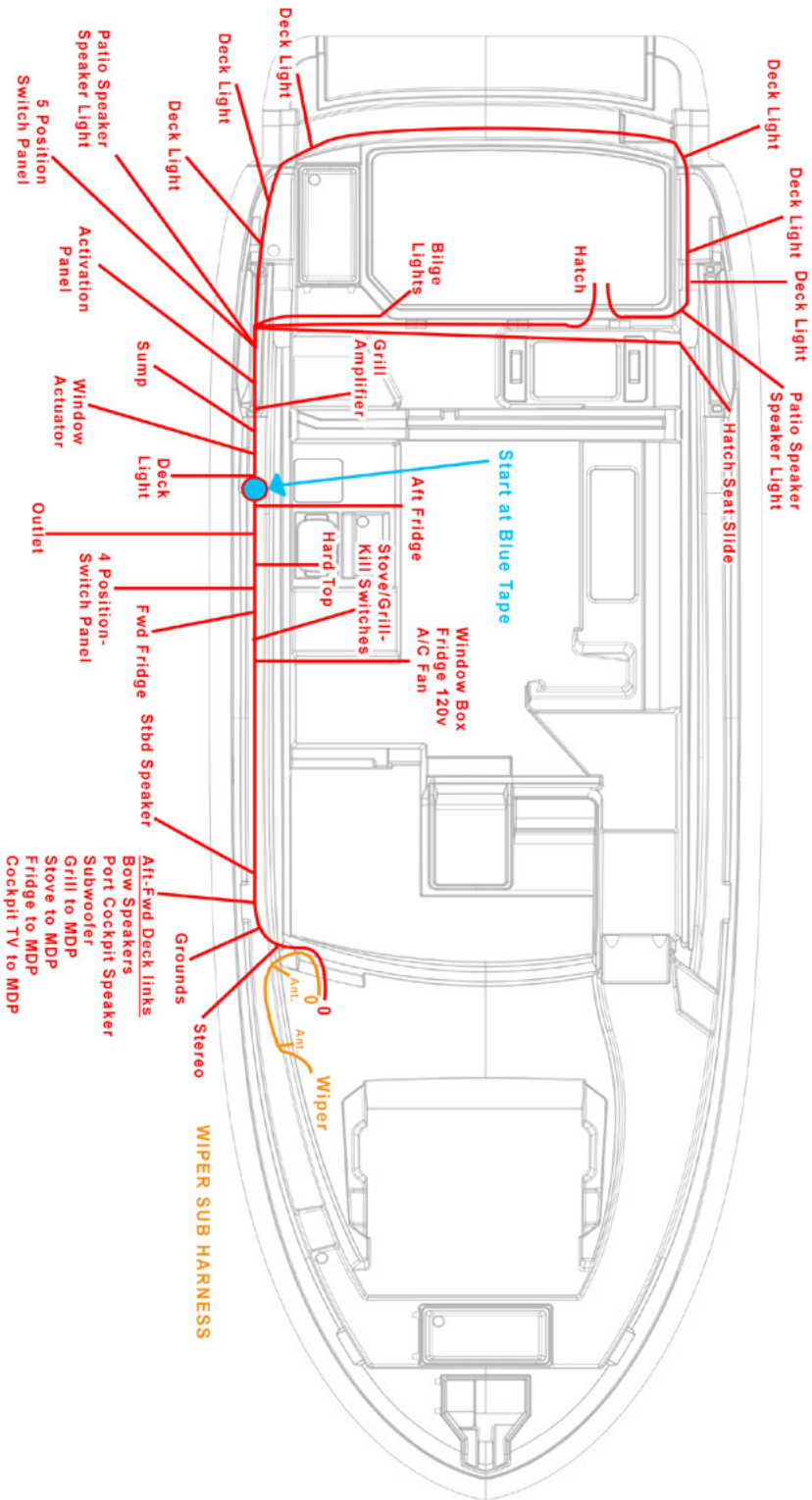



# HARNESS ROUTINGS-POWER WIRING THRU LINER

Subject Work Instruction: V/J/K Harness Routings Liner Power	Issue Date: 03/10/2020	Rev: 0	Document No. EL-108
Approved By: Dion Colbourne	Written By: Kyle Quatman	Rev Date: ....	Page: 1 of 1

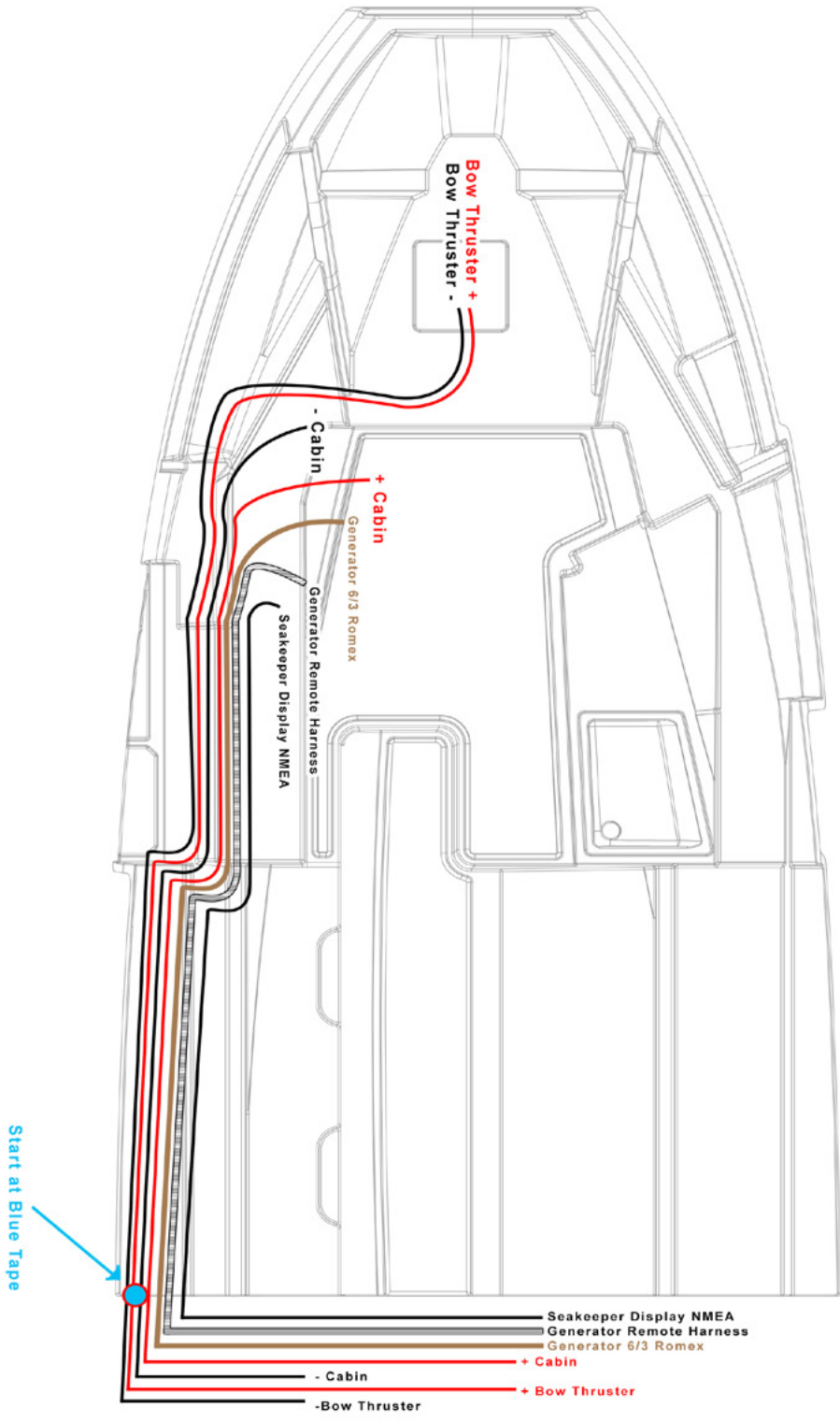

[ REFERENCE ONLY ]

# HARNESSE ROUTINGS-PORT LINER

Subject Work Instruction:	Issue Date:	Rev:	Document No.
VJ/VK Harness Routings Port Liner	03/10/2020	0	EL-110
Approved By:	Written By:	Rev Date:	Page:
Dion Colbourne	Kyle Quatman	....	1 of 1

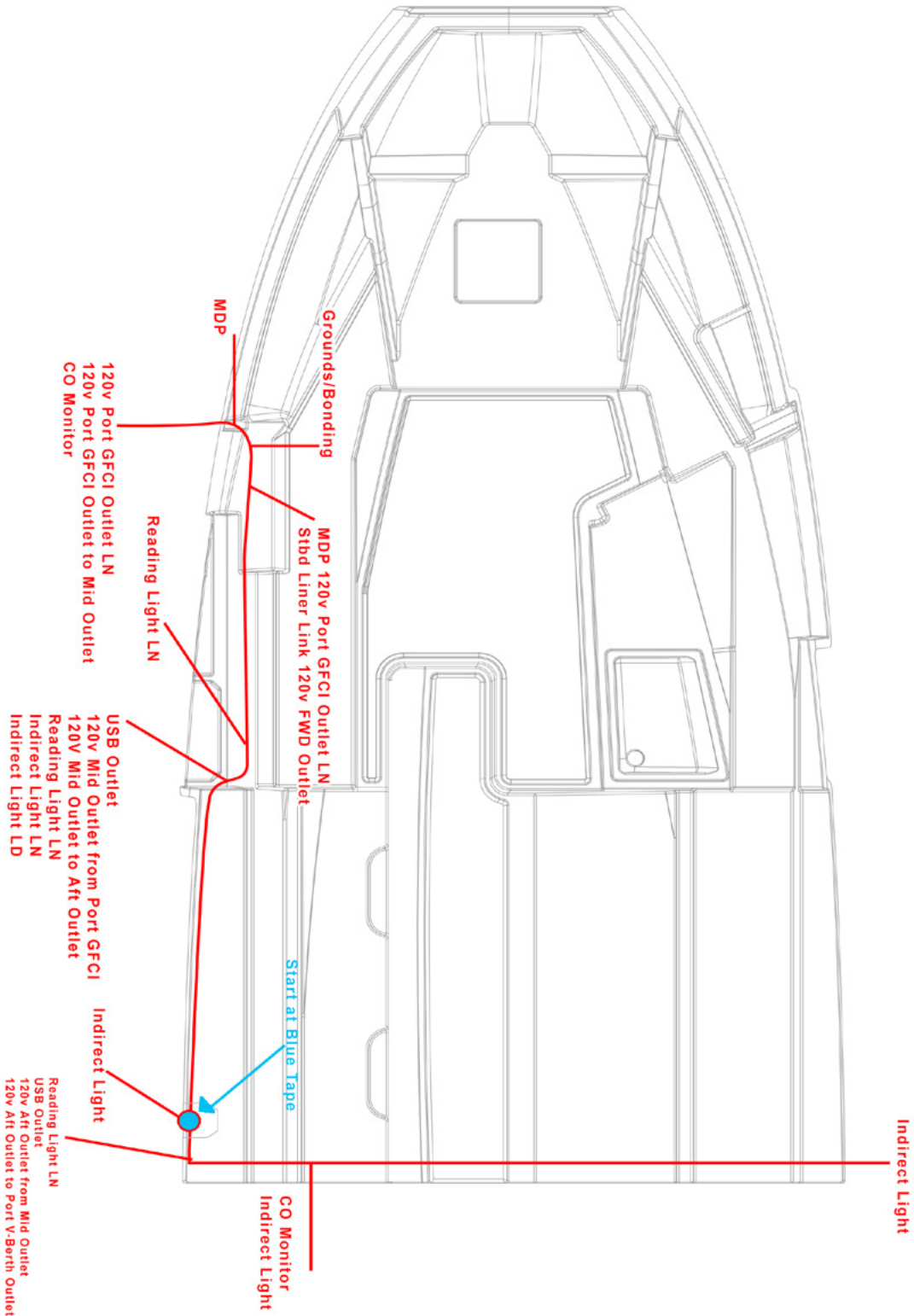

[ REFERENCE ONLY ]

# HARNESS ROUTINGS-STARBOARD LINER

Subject Work Instruction:	Issue Date:	Rev:	Document No.
V/J/K Harness Routings Stbd Liner	03/10/2020	0	EL-111
Approved By:	Written By:	Rev Date:	Page:
Dion Colbourne	Kyle Quatman	....	1 of 1

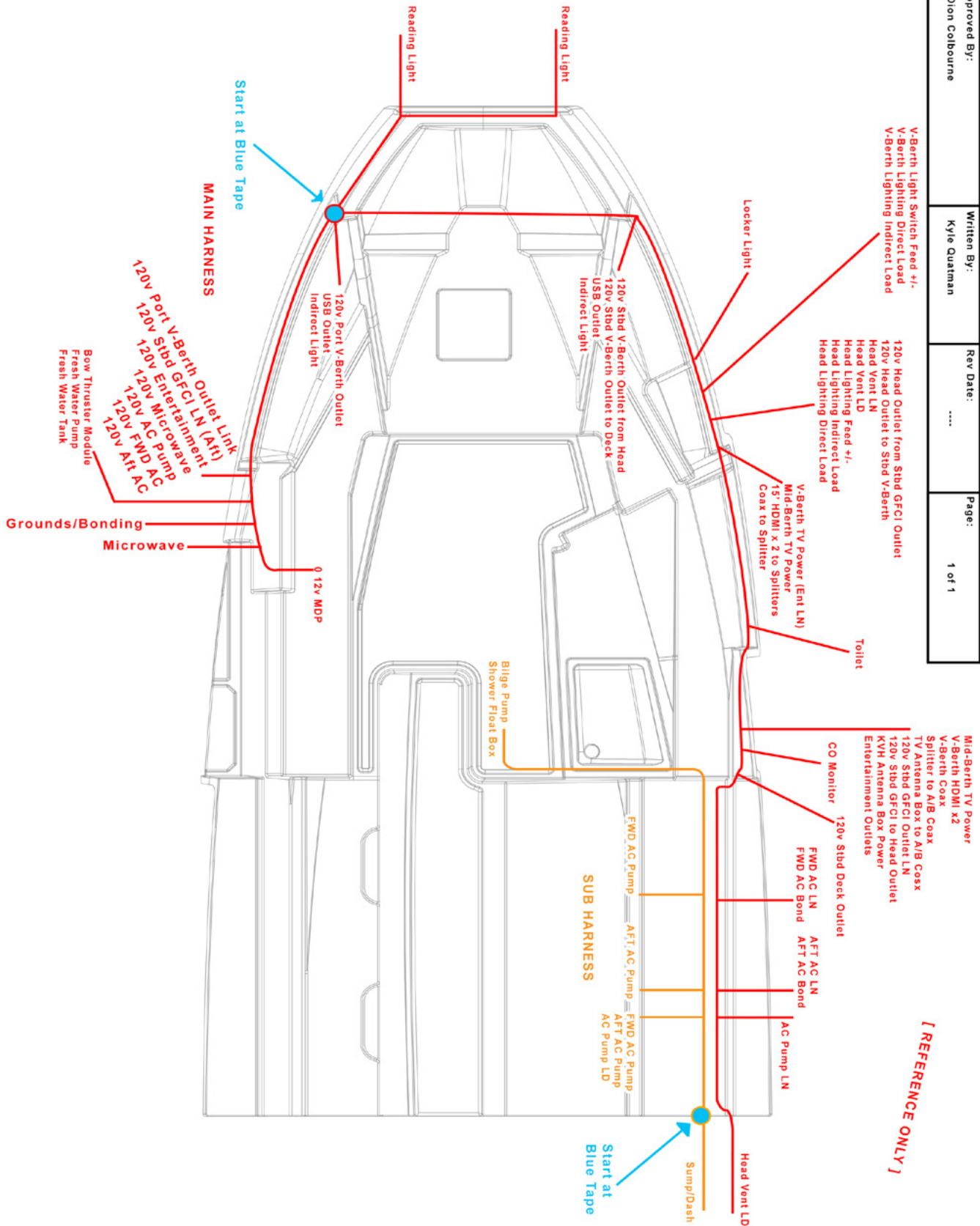

# HARNESS ROUTINGS-BILGE (SUMP) MAIN SHIP'S PANEL

Subject Work Instruction: V/J/K Harness Routings Sump MDP	Issue Date: 03/10/2020	Rev: 0	Document No. EL-109
Approved By: Dion Colbourne	Written By: Kyle Quatman	Rev Date: ....	Page: 1 of 1

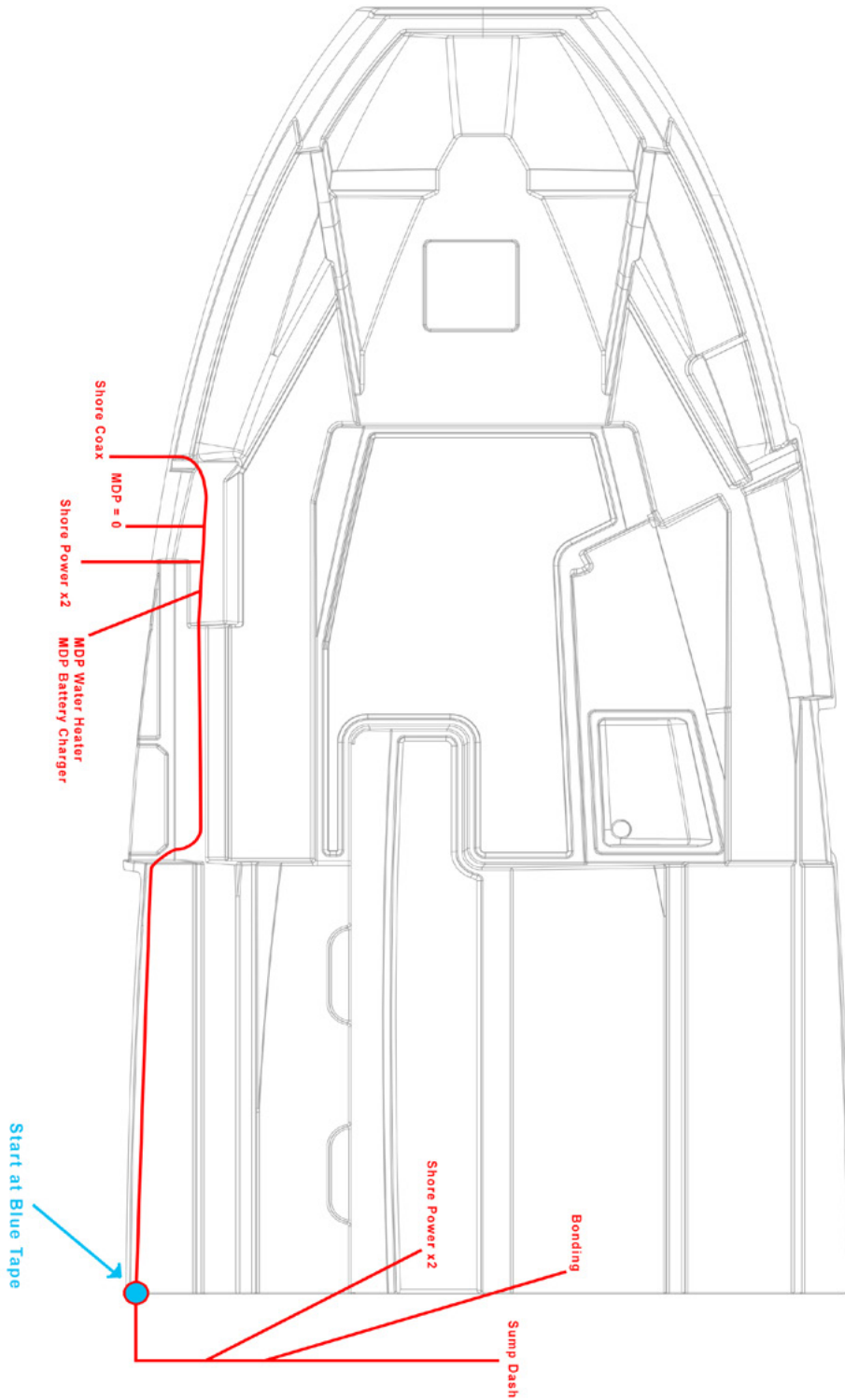

[ REFERENCE ONLY ]

# HARNESS ROUTINGS-DECK SYSTEM HARNESSES #1

Subject Work Instruction: V/J/K Deck System Harness Routing	Issue Date: 03/20/2020	Rev: 0	Document No. EL-105
Approved By: Dion Colbourne	Written By: Kyle Quatman	Rev Date: ....	Page: 1 of 2

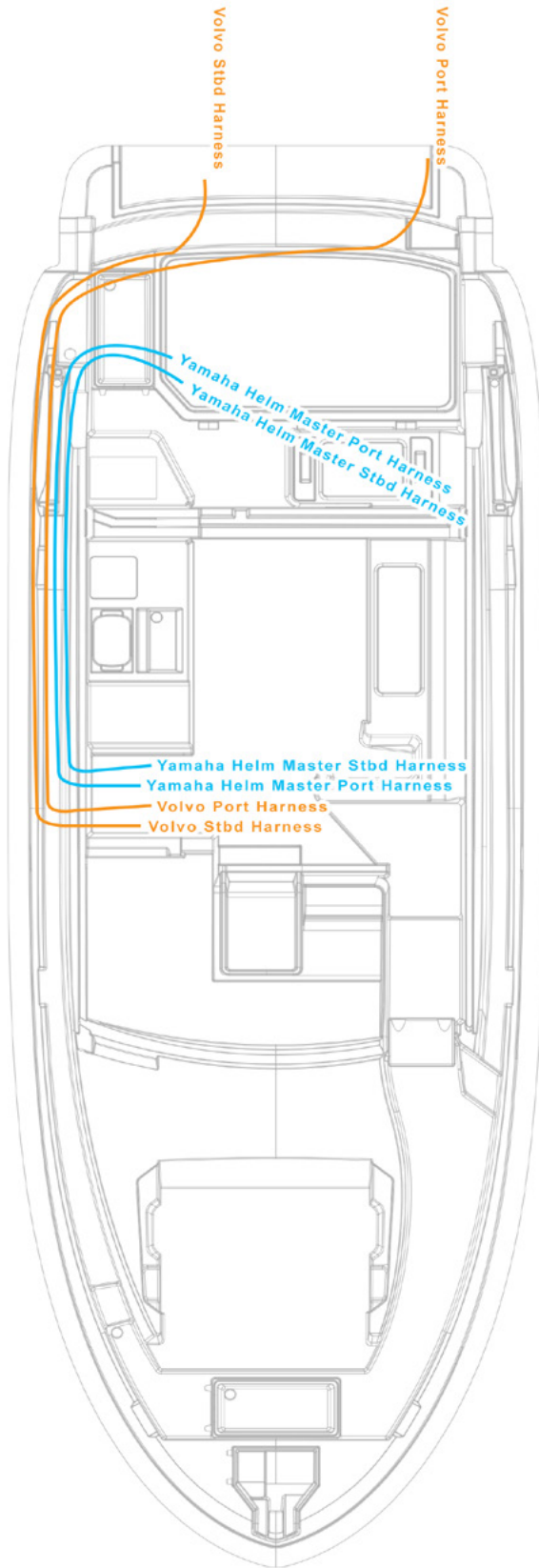

-Volvo Glass Cockpit System Only  
-Yamaha Helm Master System Only

[ REFERENCE ONLY ]



# HARNESS ROUTINGS-DECK SYSTEM HARNESSES #2

Subject Work Instruction: V/J/K Deck System Harness Routing	Issue Date: 03/20/2020	Rev: 0	Document No. EL-106
Approved By: Dion Colbourne	Written By: Kyle Quatman	Rev Date: ....	Page: 1 of 1

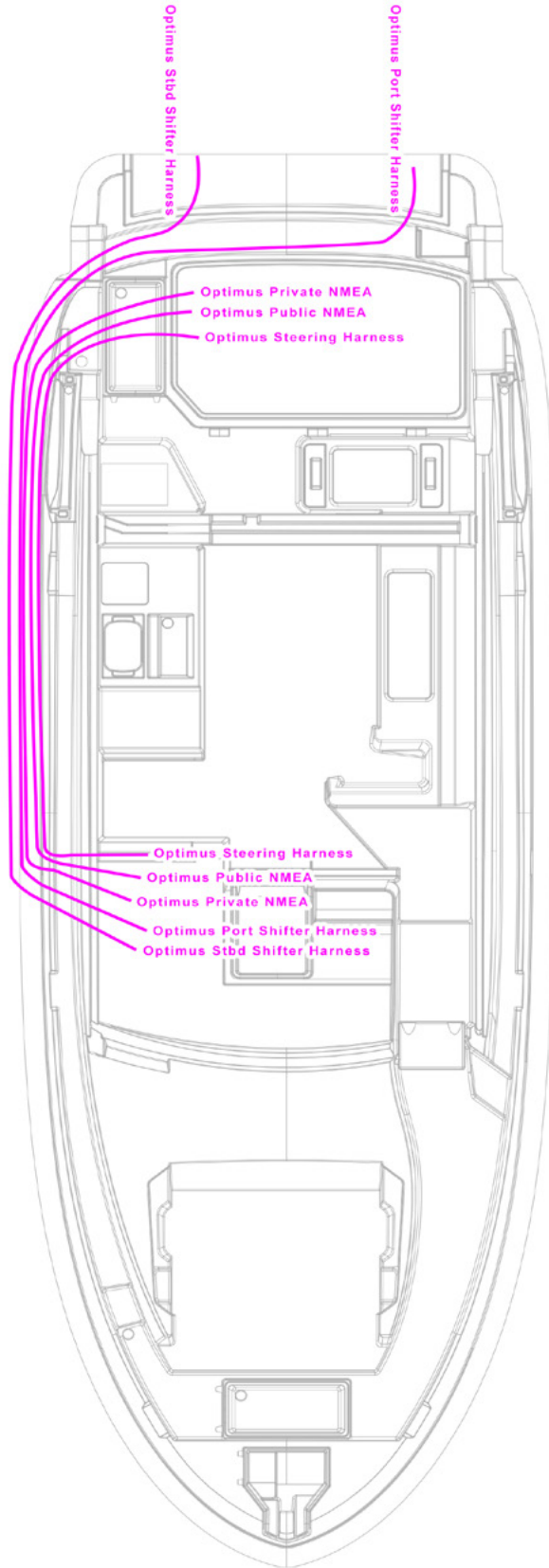

\*Yamaha Optimus System Only

[ REFERENCE ONLY ]

# HARNESS DECK ROUTINGS-OPTIONAL COMPONENTS

Subject Work Instruction: V/J/K Deck Vendor Cable Routings	Issue Date: 06/02/2020	Rev: 1	Document No. EI-104
Approved By: Dion Colbourne	Written By: Kyle Quatman	Rev Date: ....	Page: 1 of 1

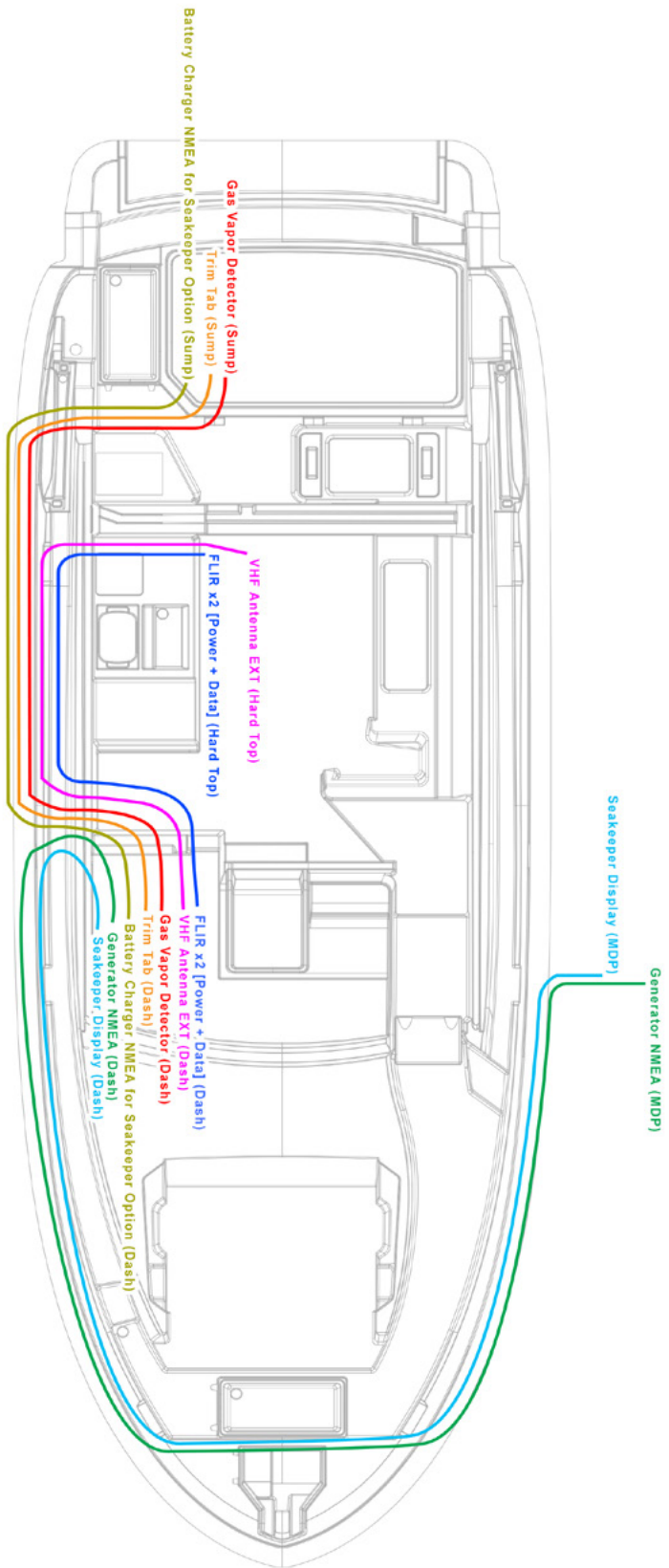

[ REFERENCE ONLY ]

# HARNESS ROUTINGS-TELEVISION SYSTEM

Subject Work Instruction: VJ/VK TV System	Issue Date: 04/24/2020	Rev: 0	Document No. EL-114
Approved By: Dion Colbourne	Written By: Kyle Quatman	Rev Date: ....	Page: 1 of 1

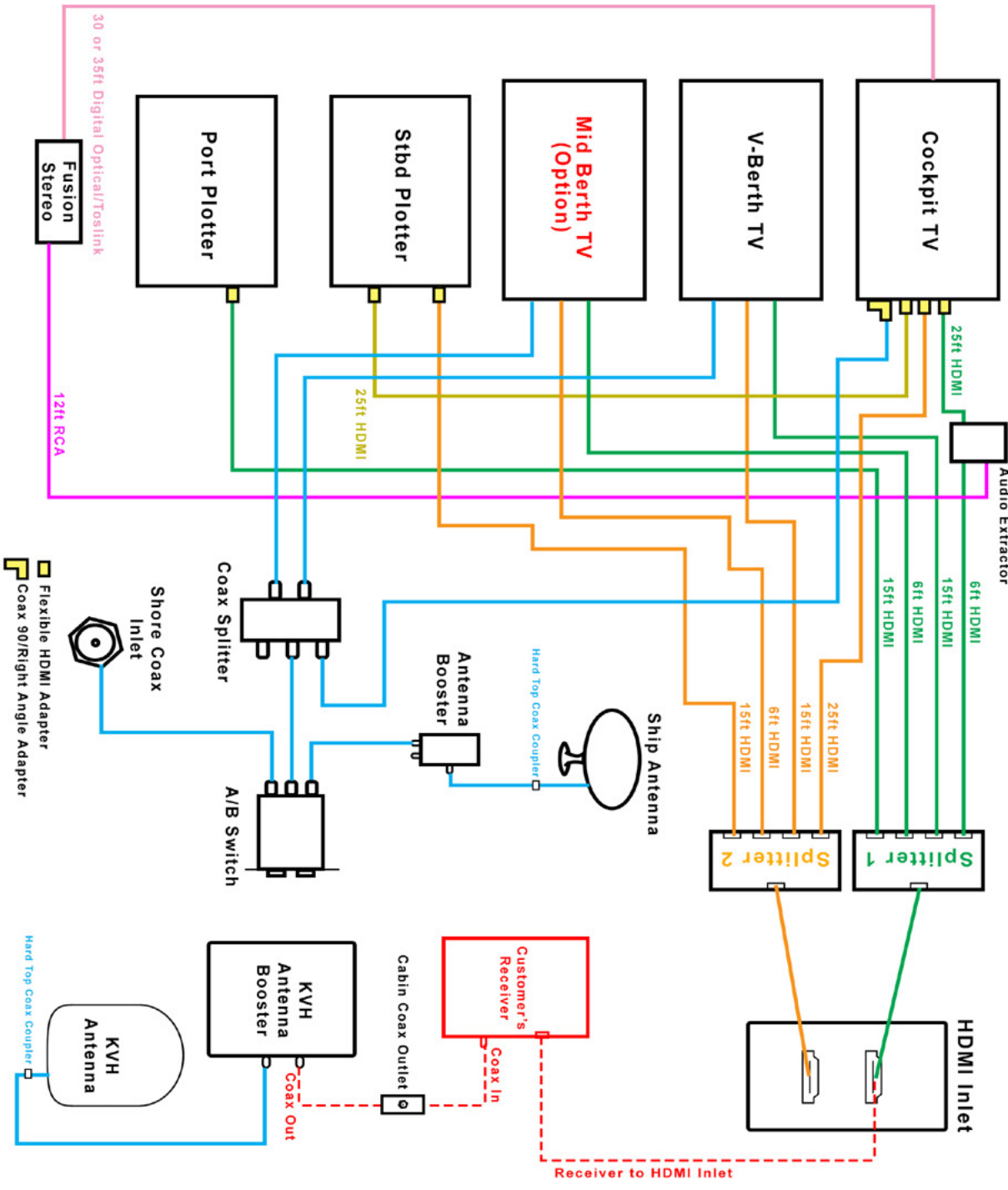

[ REFERENCE 1 ]

# BATTERY ACTIVATION PANEL-OVERVIEW

Subject Work Instruction: Battery Activation Panel	Issue Date: 05/08/2020	Rev: 0	Document No. EL-132
Approved By: Mark Journey	Written By: Kyle Quatman	Rev Date: ....	Page: 1 of 1

\*Panels May Vary. Center Battery and Macerator not available on all models.

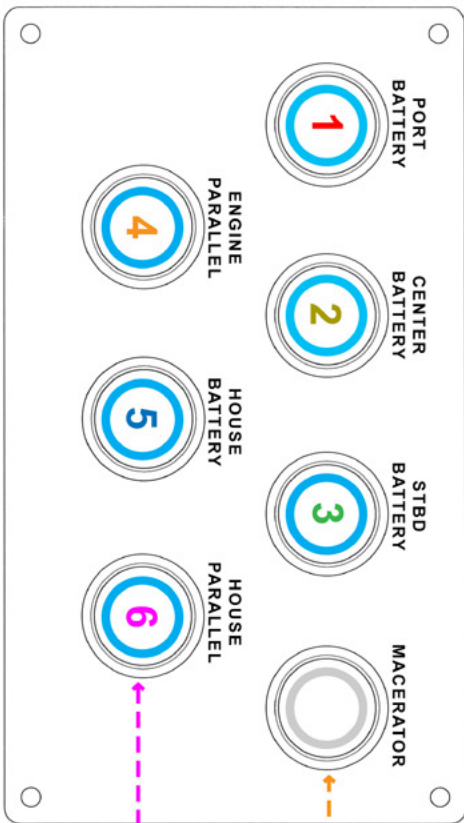

**\*Note:** The Macerator is required to have a Key Lockout by ABYC. This is located on the MDP Panel. Once the key has been turned to the ON position this button will function as normal.

**\*\*Note:** This Switch is intended to manually activate an ACR (Automatic Charging Relay), being used as a parallel device between the House Main Battery and the Stbd Engine Battery. This is for emergency power and will be automatically activated and can not be turned ON or OFF with this button. However, the Indicator light will continue to light up Blue if pushed to the ON position. When the ACR no longer detects a charge, it will be automatically deactivated and this button will then resume its function as a manual switch for the ACR.

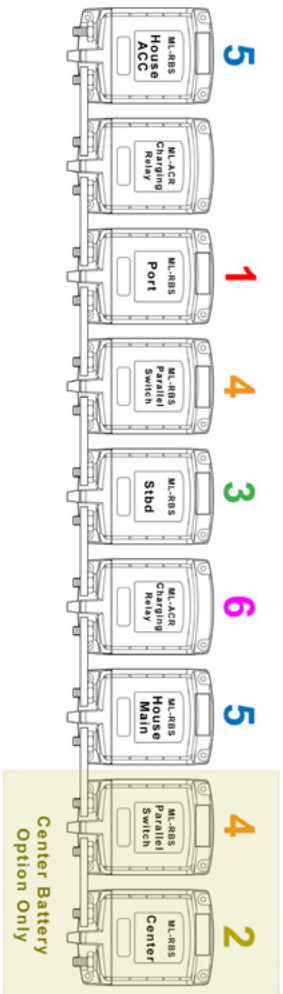

Notice Sticker is Required to be installed near Panel.

**NOTICE**

THE BATTERY PARALLEL FEATURES ON THIS VESSEL ARE INTENDED FOR EMERGENCY INTERMITTENT USE ONLY! WHEN MAINTAINING OR REPAIRING THE BATTERY, PLEASE BE SURE TO TURN OFF THE BATTERY SWITCH AND REMOVE THE KEY FROM THE BATTERY. ALWAYS WEAR YOUR SAFETY GEAR AND ALWAYS USE PROPER BATTERY HANDLING TECHNIQUES. ALWAYS USE THE BATTERY SERVICE LIFE. IS NEAR THE END OF ITS USEFUL SERVICE LIFE.

[ REFERENCE ONLY ]

# BATTERY ACTIVATION PANEL-WIRING SCHEMATIC

Subject Work Instruction: Battery Activation Panel	Issue Date: 05/08/2020	Rev: 0	Document No. EL-132
Approved By: Mark Journey	Written By: Kyle Quatman	Rev Date: ....	Page: 2 of 2

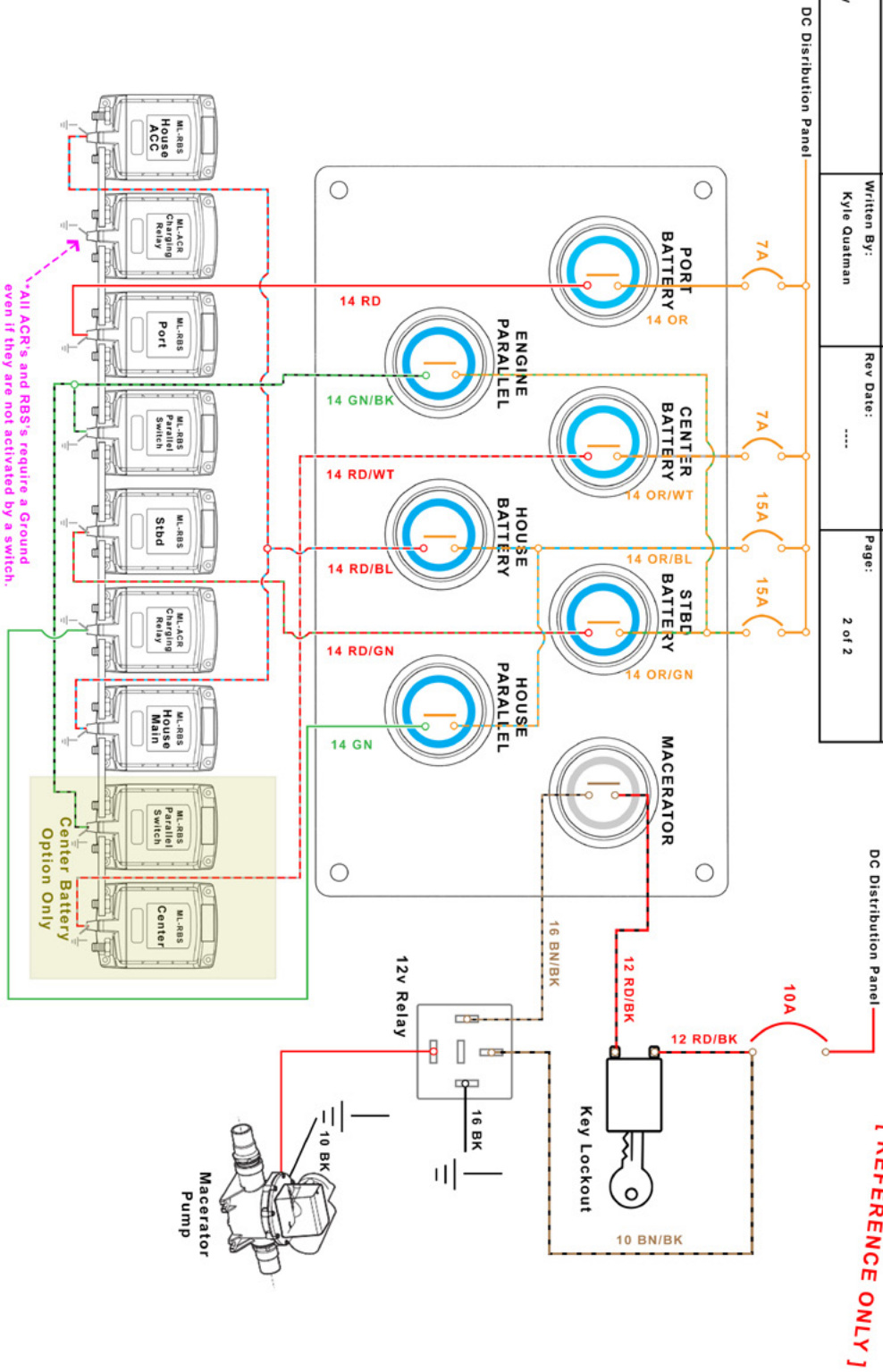



# BILGE PUMP & HIGH WATER ALARM FLOAT SWITCH WIRING

Subject Work Instruction: Bilge/High Water Float Switch Wiring	Issue Date: 05/08/2020	Rev: 0	Document No. EL-133
Approved By: Mark Journey	Written By: Kyle Quatman	Rev Date: ----	Page: 1 of 1

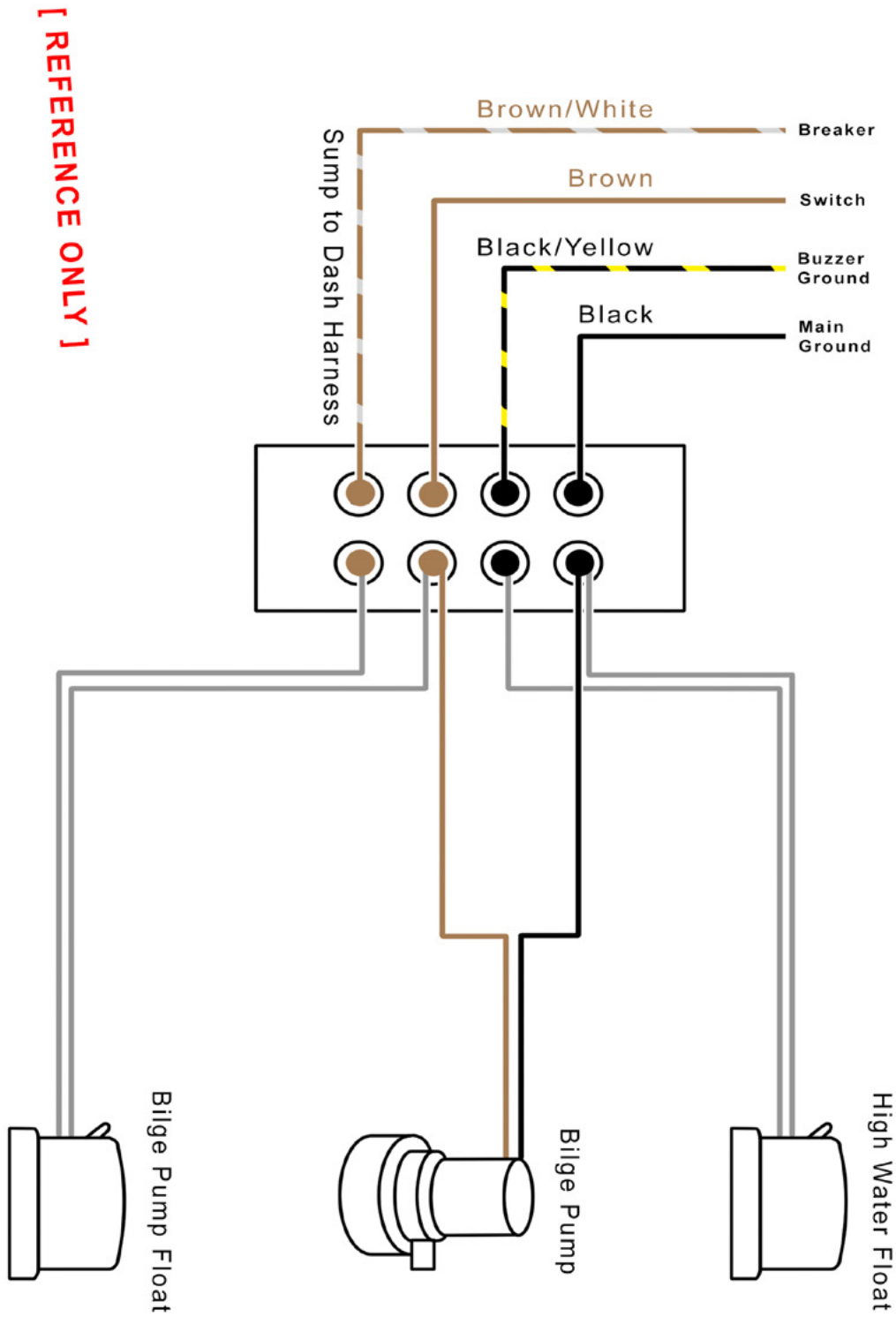

[ REFERENCE ONLY ]

# AUTOMATIC FIRE EXTINGUISHING SYSTEM WIRING

Subject Work Instruction: Fireboy System, 2 Blowers w/ MDP	Issue Date: 04/24/2020	Rev: 0	Document No. EL-133
Approved By: Mark Journey	Written By: Kyle Quatman	Rev Date: ....	Page: 1 of 1

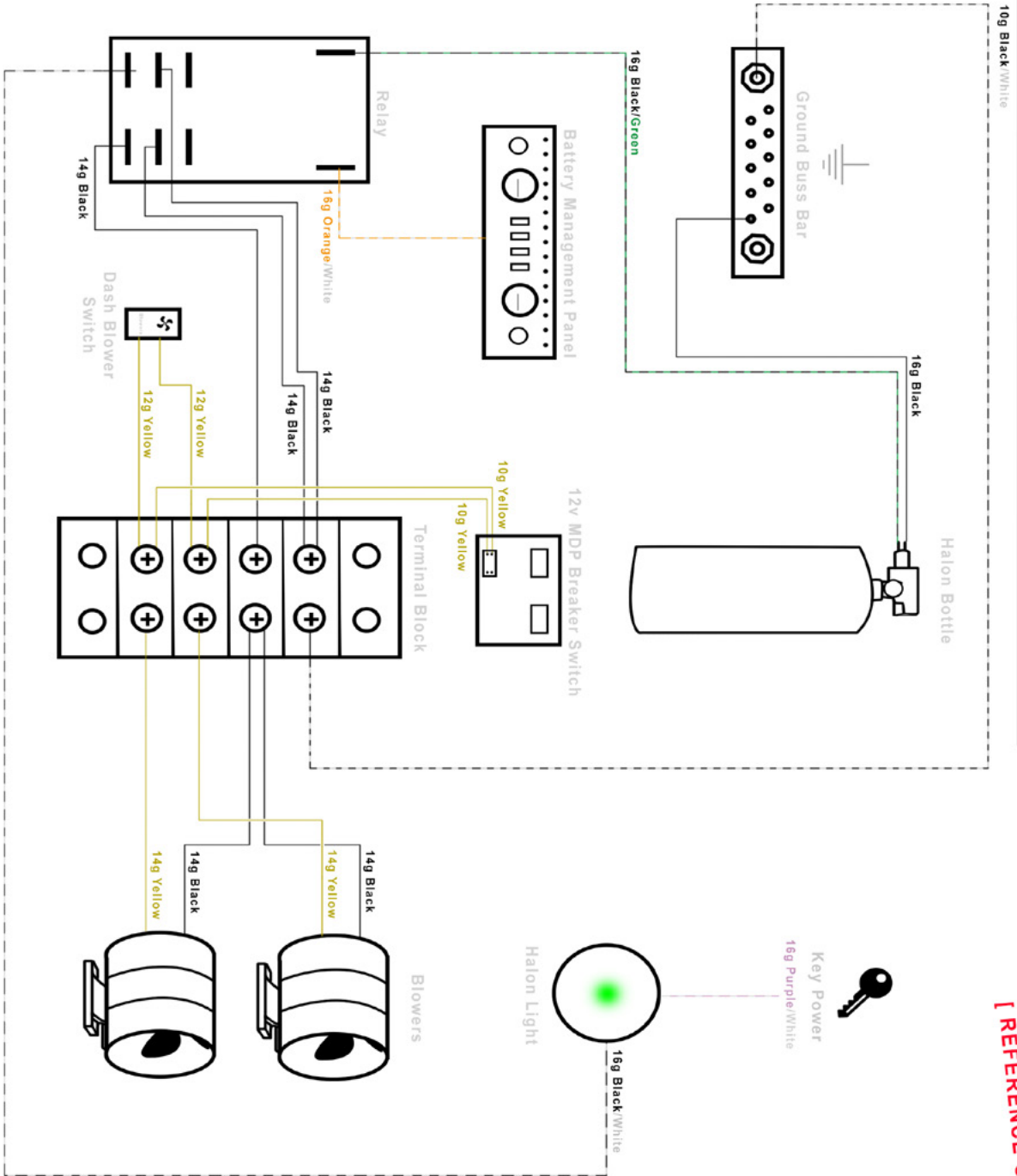

[ REFERENCE ONLY ]

# ELCI BREAKER ASSEMBLY WIRING NOTES

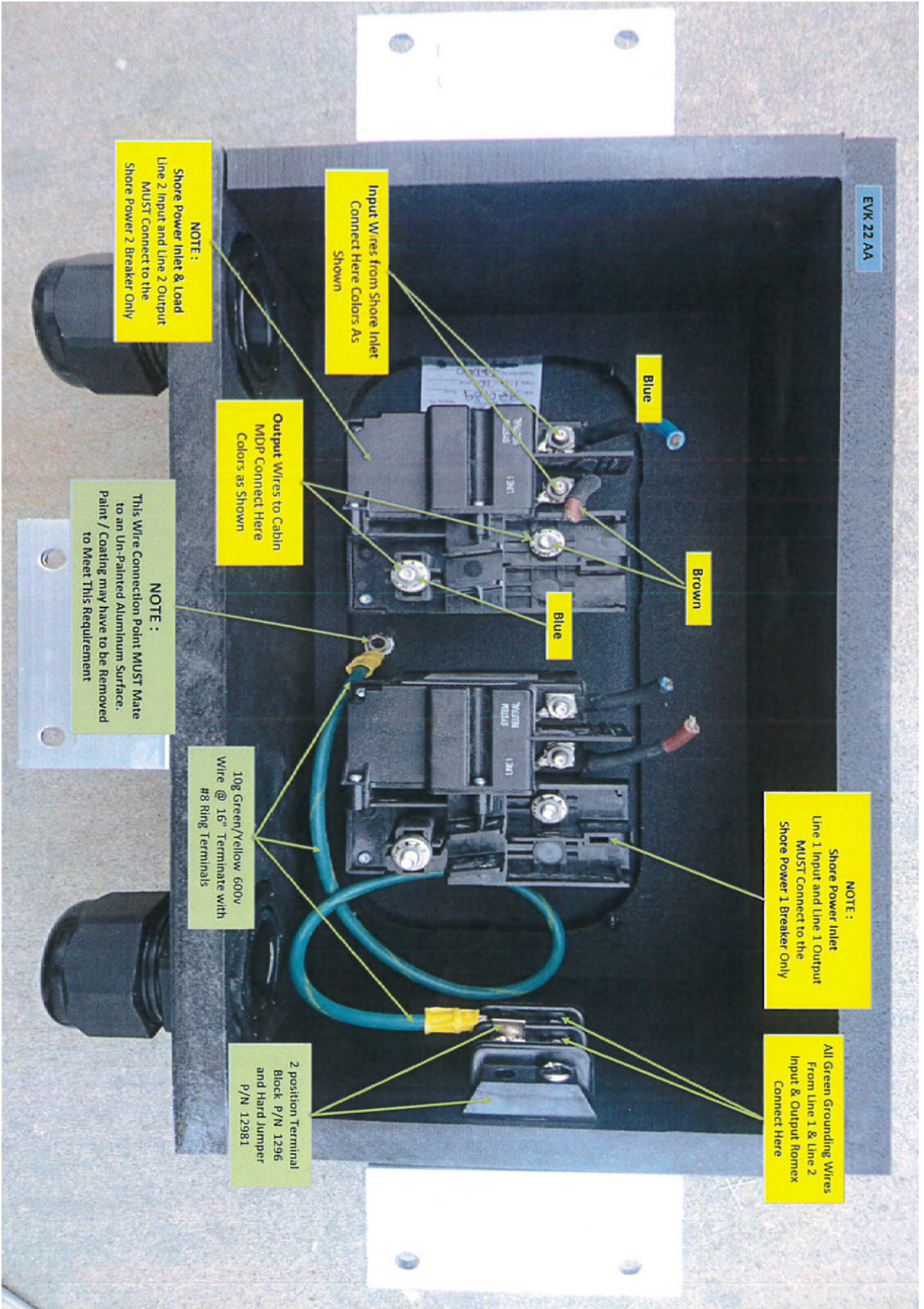

EVK 22 AA

Input Wires from Shore Inlet  
Connect Here Colors As  
Shown

Blue

Brown

Blue

Output Wires to Cabin  
MDP Connect Here  
Colors as Shown

NOTE:  
Shore Power Inlet & Load  
Line 2 Input and Line 2 Output  
MUST Connect to the  
Shore Power 2 Breaker Only

NOTE :  
This Wire Connection Point MUST Mate  
to an Un-Painted Aluminum Surface.  
Paint / Coating may have to be Removed  
to Meet This Requirement

NOTE :  
Shore Power Inlet  
Line 1 Input and Line 1 Output  
MUST Connect to the  
Shore Power 1 Breaker Only

All Green Grounding Wires  
From Line 1 & Line 2  
Input & Output Romex  
Connect Here

10g Green/Yellow 600V  
Wire @ 16" Terminate with  
#8 Ring Terminals

2 position Terminal  
Block P/N 1296  
and Hard Jumper  
P/N 12981

NOTE THAT THE ELCI SHOWN HERE IS FOR REFERENCE ONLY. THE ELCI BREAKER CONTAINS HIGH AC VOLTAGE. INSPECTION AND OR REPAIRS TO BE DONE ONLY BY AN AUTHORIZED MARINE ELECTRICAL TECHNICIAN.



# GARMIN NETWORK- ETHERNET CARD READER

Subject Work Instruction: Garmin Network w/ Ethernet Card Reader <b>With 3 or more Network Options</b>	Issue Date: 04/24/2020	Rev: 0	Document No. EL-121
Approved By: Dion Colbourne	Written By: Kyle Quatman	Rev Date: ----	Page: 1 of 1



# GARMIN NETWORK- USB CARD READER

Subject Work Instruction: Garmin Network w USB Card Reader <b>With 3 or more Network Options</b>	Issue Date: 04/24/2020	Rev: 0	Document No. EL-122
Approved By: Dion Colbourne	Written By: Kyle Quatman	Rev Date: ----	Page: 1 of 1

Garmin USB Card Reader Compatible Plotters Only.





# SEAKEEPER 3 POWER/NETWORK WIRING

Subject Work Instruction: Seakeeper 3 Power & Network	Issue Date: 04/24/2020	Rev: 0	Document No. EL-136
Approved By: Dion Colbourne	Written By: Kyle Quatman	Rev Date: ----	Page: 1 of 1

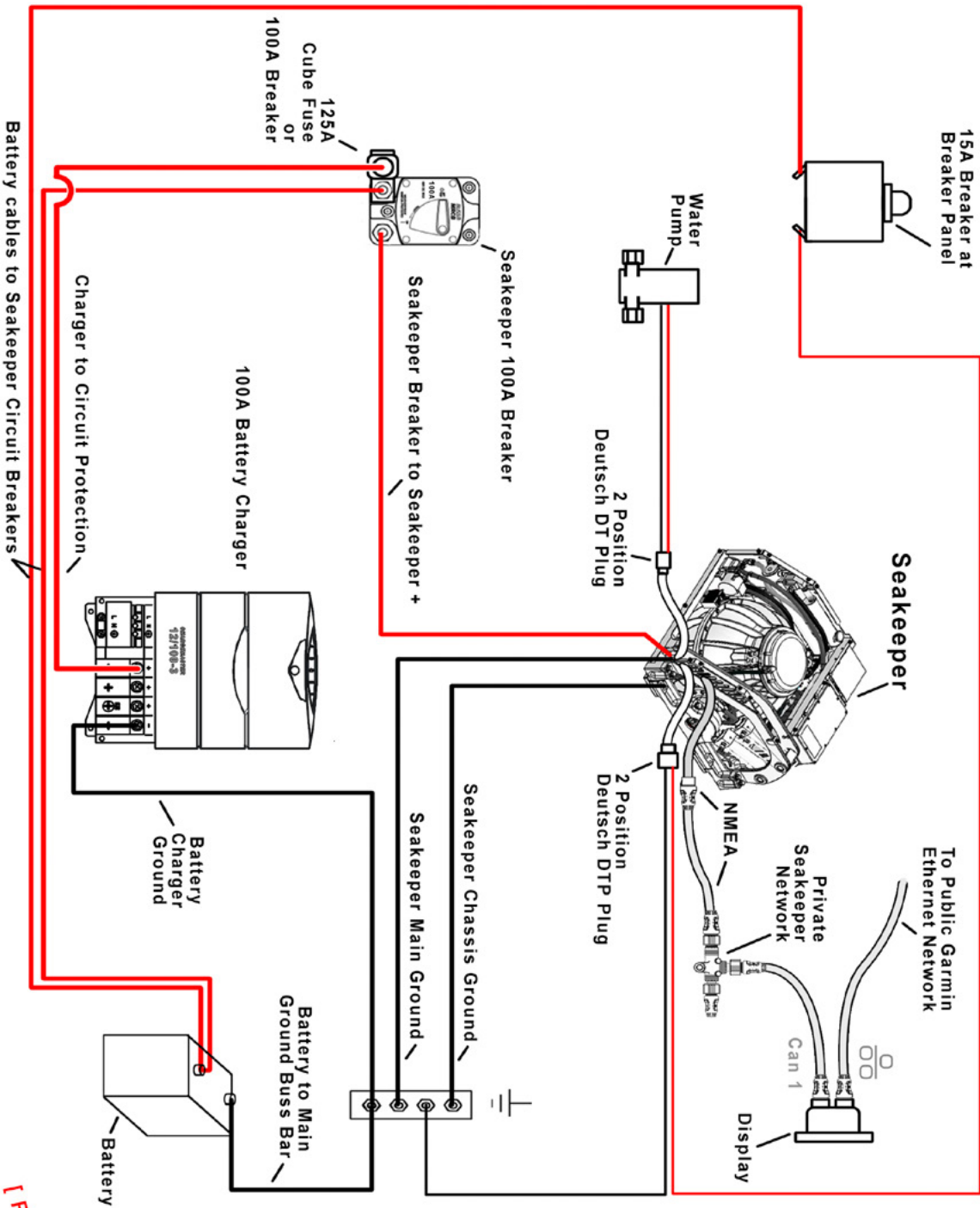

[ REFERENCE ONLY ]

# WATER HEATER COMPONENTS/FUNCTIONS

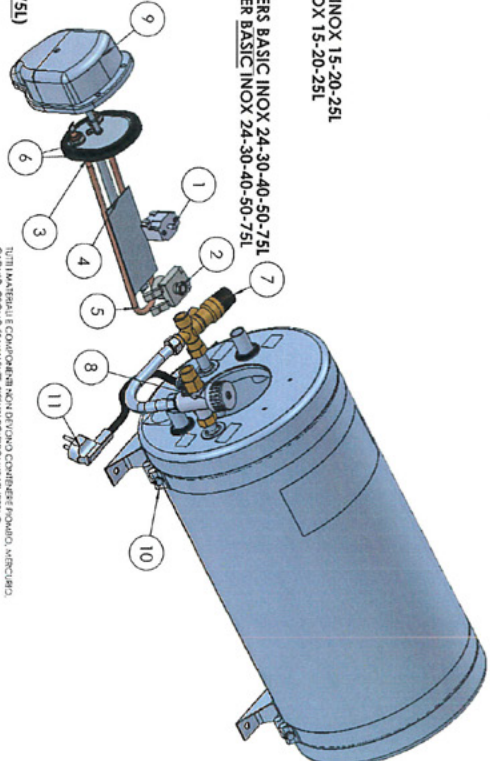
TUTTI I MATERIALI E I COMPONENTI NON SONO DI ORIGINE COMMERCIALE ITALIANA. IL CLIENTE DEVE VERIFICARE LA QUALITÀ DEI COMPONENTI E DEI MATERIALI PRIMA DI UTILIZZARLI. IL CLIENTE È RESPONSABILE DELLA SCELTA DEI COMPONENTI E DEI MATERIALI. IL CLIENTE DEVE VERIFICARE LA QUALITÀ DEI COMPONENTI E DEI MATERIALI PRIMA DI UTILIZZARLI.	
TUTTI I MATERIALI E I COMPONENTI NON SONO DI ORIGINE COMMERCIALE ITALIANA. IL CLIENTE DEVE VERIFICARE LA QUALITÀ DEI COMPONENTI E DEI MATERIALI PRIMA DI UTILIZZARLI. IL CLIENTE È RESPONSABILE DELLA SCELTA DEI COMPONENTI E DEI MATERIALI. IL CLIENTE DEVE VERIFICARE LA QUALITÀ DEI COMPONENTI E DEI MATERIALI PRIMA DI UTILIZZARLI.	
TUTTI I MATERIALI E I COMPONENTI NON SONO DI ORIGINE COMMERCIALE ITALIANA. IL CLIENTE DEVE VERIFICARE LA QUALITÀ DEI COMPONENTI E DEI MATERIALI PRIMA DI UTILIZZARLI. IL CLIENTE È RESPONSABILE DELLA SCELTA DEI COMPONENTI E DEI MATERIALI. IL CLIENTE DEVE VERIFICARE LA QUALITÀ DEI COMPONENTI E DEI MATERIALI PRIMA DI UTILIZZARLI.	
TUTTI I MATERIALI E I COMPONENTI NON SONO DI ORIGINE COMMERCIALE ITALIANA. IL CLIENTE DEVE VERIFICARE LA QUALITÀ DEI COMPONENTI E DEI MATERIALI PRIMA DI UTILIZZARLI. IL CLIENTE È RESPONSABILE DELLA SCELTA DEI COMPONENTI E DEI MATERIALI. IL CLIENTE DEVE VERIFICARE LA QUALITÀ DEI COMPONENTI E DEI MATERIALI PRIMA DI UTILIZZARLI.	

DESCRIZIONE		MATERIE PLASTICHE		RISERVA		CATEGORIA	
BASIC/ SLIM WATER HEATERS		PLASTICA		RISERVA		CATEGORIA	
VIA DEI RISPONDI 11 - 47024 SERRAVALLE (RN) - ITALIA		VIA DEI RISPONDI 11 - 47024 SERRAVALLE (RN) - ITALIA		VIA DEI RISPONDI 11 - 47024 SERRAVALLE (RN) - ITALIA		VIA DEI RISPONDI 11 - 47024 SERRAVALLE (RN) - ITALIA	
TEL. +39 0543 47024		TEL. +39 0543 47024		TEL. +39 0543 47024		TEL. +39 0543 47024	
FAX +39 0543 47024		FAX +39 0543 47024		FAX +39 0543 47024		FAX +39 0543 47024	
WWW.AQUAERKA.IT		WWW.AQUAERKA.IT		WWW.AQUAERKA.IT		WWW.AQUAERKA.IT	
E-MAIL: INFO@AQUAERKA.IT		E-MAIL: INFO@AQUAERKA.IT		E-MAIL: INFO@AQUAERKA.IT		E-MAIL: INFO@AQUAERKA.IT	
A. BERNINI & C. S.p.A. - VIA DEI RISPONDI 11 - 47024 SERRAVALLE (RN) - ITALIA		A. BERNINI & C. S.p.A. - VIA DEI RISPONDI 11 - 47024 SERRAVALLE (RN) - ITALIA		A. BERNINI & C. S.p.A. - VIA DEI RISPONDI 11 - 47024 SERRAVALLE (RN) - ITALIA		A. BERNINI & C. S.p.A. - VIA DEI RISPONDI 11 - 47024 SERRAVALLE (RN) - ITALIA	

## **36 OUTBOARD ONLY DRAWINGS (VESSEL HIN=VK)**

*NOTE AS PART OF REGAL'S COMMITMENT TO PRODUCT IMPROVEMENT SPECIFICATIONS, COMPONENTS, AND LOCATIONS DISPLAYED IN DRAWINGS AND/OR DOCUMENTATION MAY CHANGE AT ANY TIME. SELECT COMPONENTS ARE OPTIONAL AND MAY NOT BE INSTALLED ON YOUR VESSEL.*

*NOTE TO READ SPECIFIC TITLE BOXES FOR DRAWING MODEL TYPE AND DESCRIPTION. MODEL SPECIFIC INFORMATION ON INDIVIDUAL DRAWINGS IS NOTED BY AN \* SYSTEM.*

# MAIN DIMENSIONS

## 36 XO Outboard Main Dimensions

LOA With Outboard Engines 463  $\frac{1}{4}$ "

LOA With Swim Platform 446  $\frac{3}{16}$ "

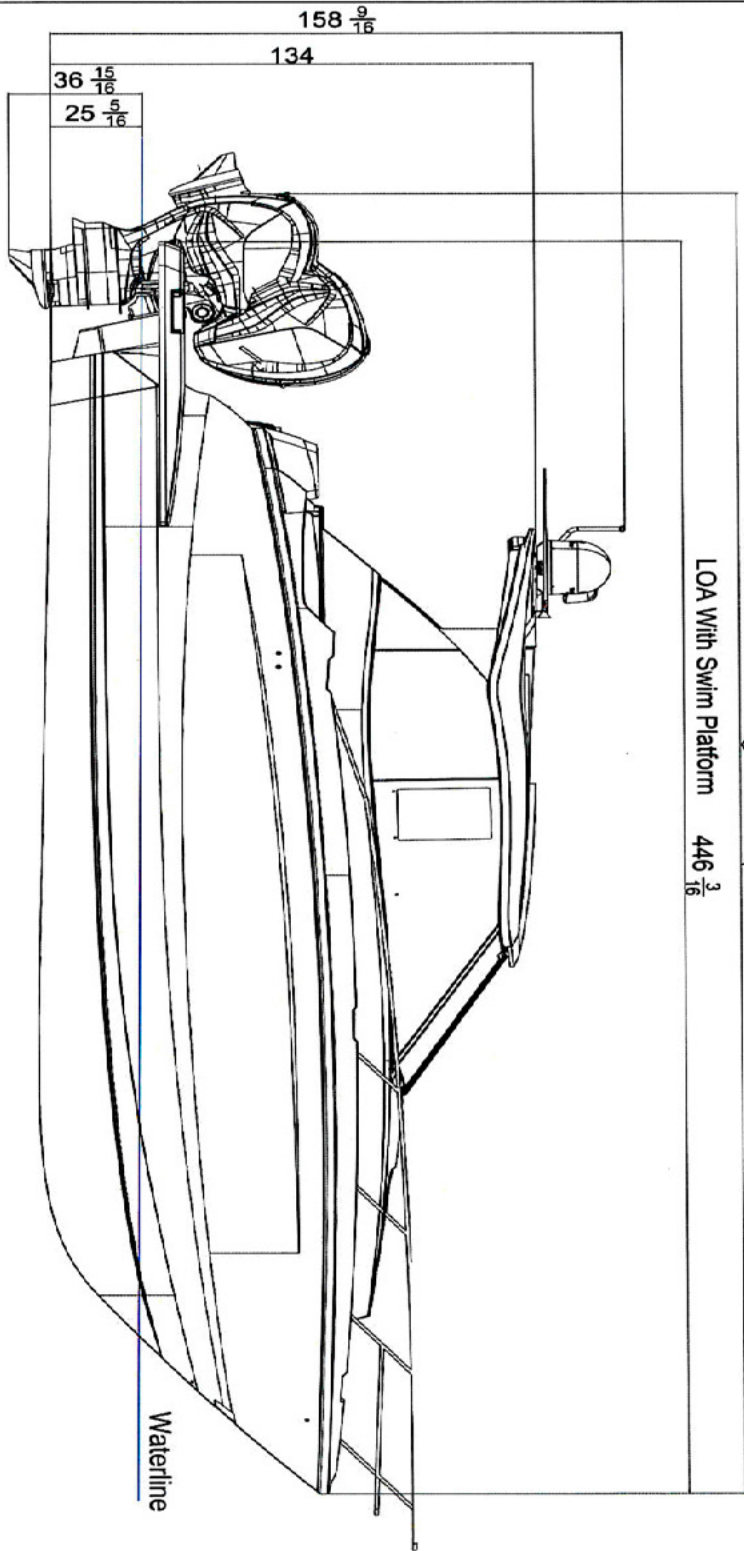

Beam: 136"  
 Chine Beam: 114  $\frac{1}{2}$ "  
 Deadrise: 15.8°

**REFERENCE ONLY**

THIS DRAWING AND CONTENTS ARE THE PROPERTY OF REGAL MARINE INDUSTRIES AND REPRODUCTION IN ANY MANNER WITHOUT THE WRITTEN PERMISSION OF REGAL MARINE INDUSTRIES IS PROHIBITED.

<b>REGAL MARINE INDUSTRIES</b> <small>1400 AIRPORT DRIVE                  DEERFIELD BEACH, FLORIDA 33442                  (561) 771-1000</small>			
<small>ALL RIGHTS RESERVED</small>			
Drawing Title: <b>36 XO Outboard Main Dimensions</b>			
DATE:	REVISION:	PAGE:	
05/16/2020	-	1 OF 1	
DRAWN BY:	APPROVED BY:	DWG NO.:	
DMC	-	-	



# MAIN DIMENSIONS 2

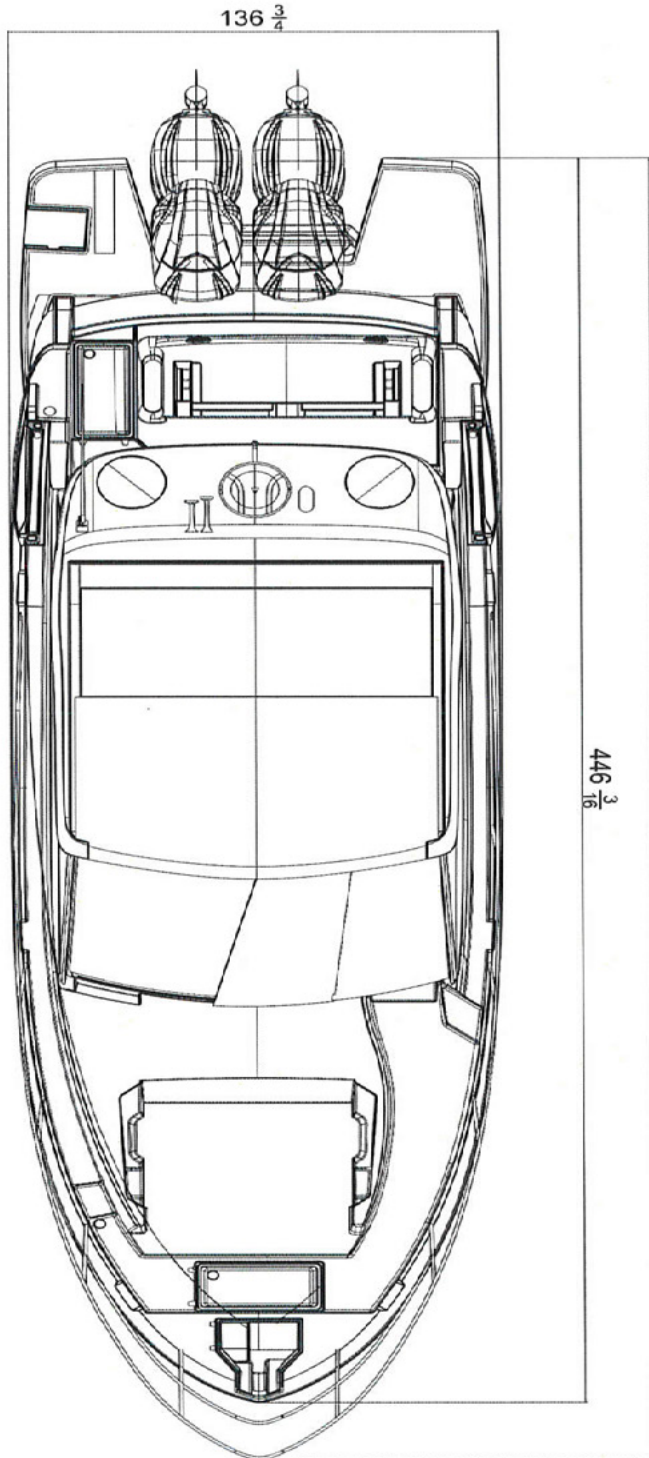

**REFERENCE ONLY**

REGAL MARINE INDUSTRIES, INC. AND REGAL MARINE INDUSTRIES, LLC ARE THE SOLE AND EXCLUSIVE PROPRIETORS OF ALL RIGHTS IN THE DESIGN, CONSTRUCTION, AND OPERATION OF ALL REGAL MARINE INDUSTRIES PRODUCTS. ANY REPRODUCTION, IN PART OR IN WHOLE, WITHOUT THE WRITTEN PERMISSION OF REGAL MARINE INDUSTRIES IS PROHIBITED.

DRAWING TITLE			
<b>36 XO (VK) Main Dimensions</b>			
DATE	REVISED	BY	DATE
06/16/2020	-	-	2 OF 2
DRAWN BY	APPROVED BY	DATE	
DMC	-	-	
REGAL MARINE INDUSTRIES 1711 MARINE BLVD DAVENPORT, FLORIDA 33445 ALL RIGHTS RESERVED			



# DOMESTIC SEATING POSITIONS

15.5" W X 29.5" L  
Allowance Per Person



Domestic Seating Positions: 13 Persons

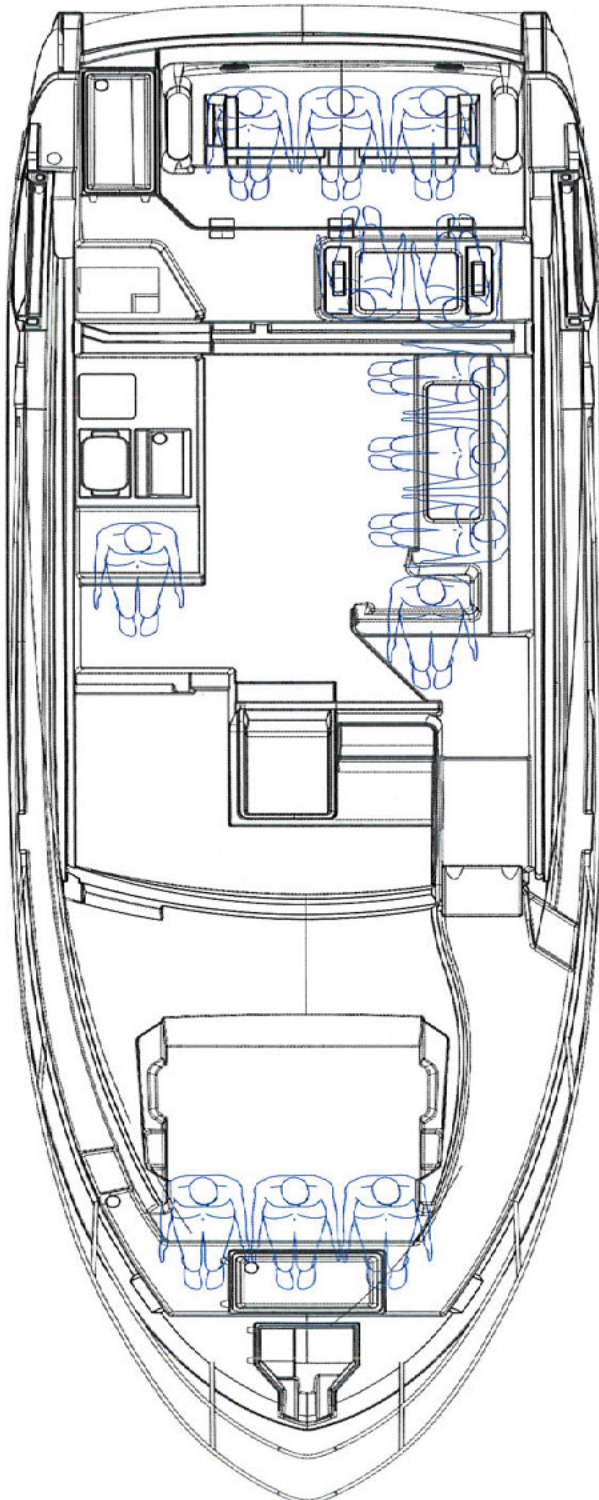

NOTE THAT THE FORWARD SEAT IS NOT TO BE OCCUPIED WHILE MAKING HEADWAY.

## REFERENCE ONLY

FIGURES ARE FOR REFERENCE ONLY. THE CAPACITY OF THIS VESSEL IS LIMITED BY THE U.S. DEPARTMENT OF MARINE TRANSPORTATION AND IS SUBJECT TO CHANGE WITHOUT NOTICE. THE CAPACITY OF THIS VESSEL IS LIMITED BY THE U.S. DEPARTMENT OF MARINE TRANSPORTATION AND IS SUBJECT TO CHANGE WITHOUT NOTICE. THE CAPACITY OF THIS VESSEL IS LIMITED BY THE U.S. DEPARTMENT OF MARINE TRANSPORTATION AND IS SUBJECT TO CHANGE WITHOUT NOTICE.

DRAWING TITLE		REGAL MARINE INDUSTRIES	
DATE		DATE	
6/24/2020	6/24/2020	DESIGNED BY	DESIGNED BY
DMC	DMC	APPROVED BY	APPROVED BY
36 Outboard Domestic Seating Capacity		1 OF 1	
SCALE		SCALE	
		2	

# BATTERY DESCRIPTION- TYPICAL 36 OUTBOARD

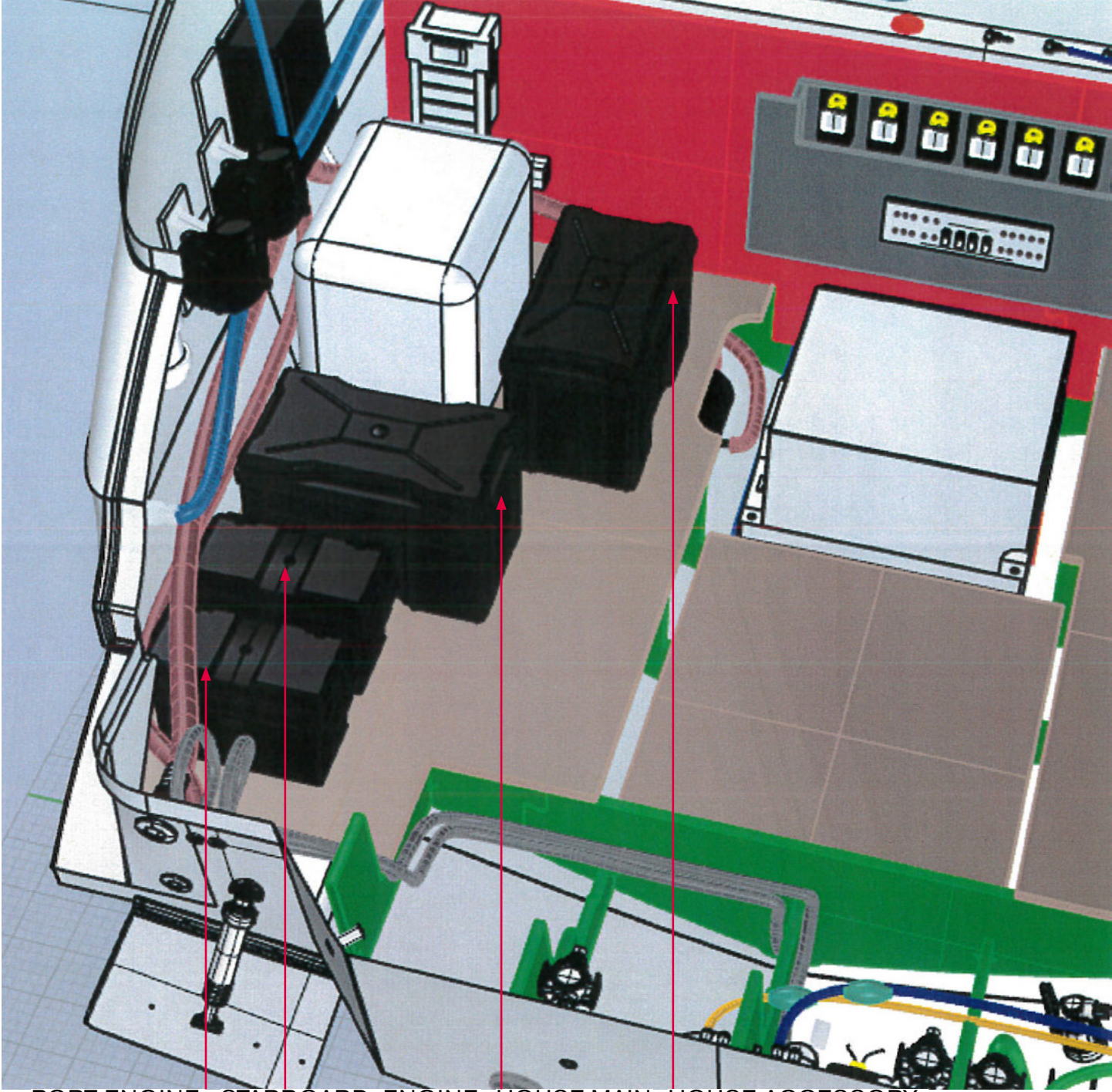

PORT ENGINE BATTERY

STARBOARD ENGINE BATTERY

HOUSE MAIN BATTERY

HOUSE ACCESSORY BATTERY



# YAMAHA HELM MASTER STEERING FUEL/WATER LEVEL HARNESS

Subject Work Instruction: Yamaha Helm Master Fuel (Twin Engine)	Issue Date: 04/24/2020	Rev: 0	Document No. EL-115
Approved By: Dion Colbourne	Written By: Kyle Quatman	Rev Date: ----	Page: 1 of 1

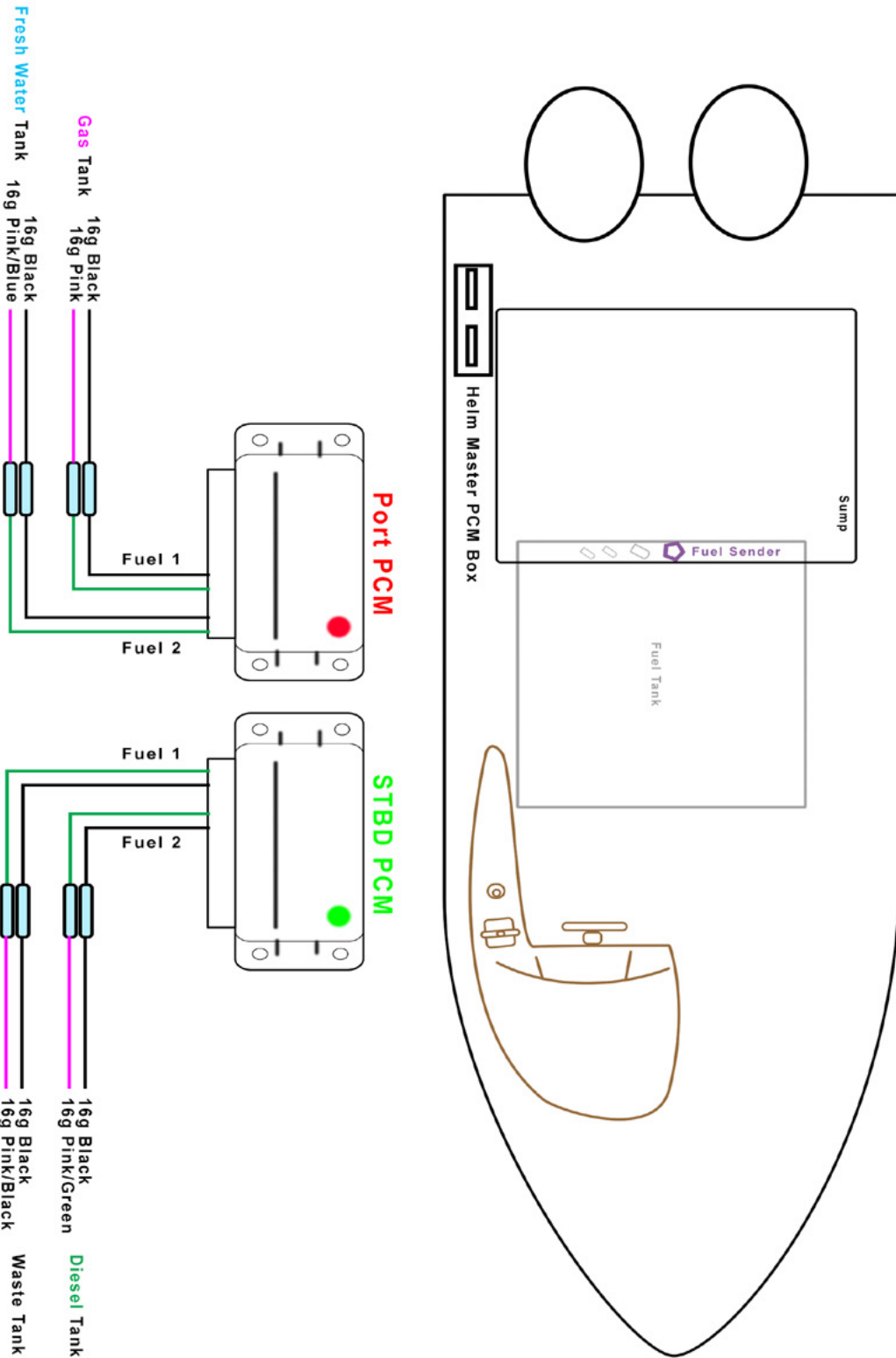

# YAMAHA HYDRAULIC STEERING FUEL/WATER LEVEL HARNESS

Subject Work Instruction: Yamaha Optimus Fuel/Water Level	Issue Date: 04/24/2020	Rev: 0	Document No. EL-120
Approved By: Dion Colbourne	Written By: Kyle Quatman	Rev Date: ....	Page: 1 of 1

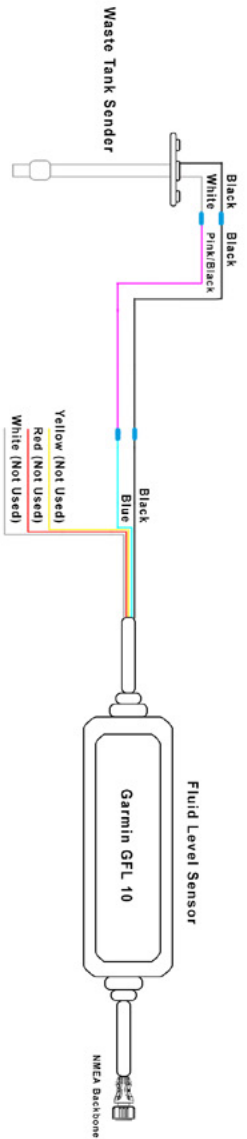
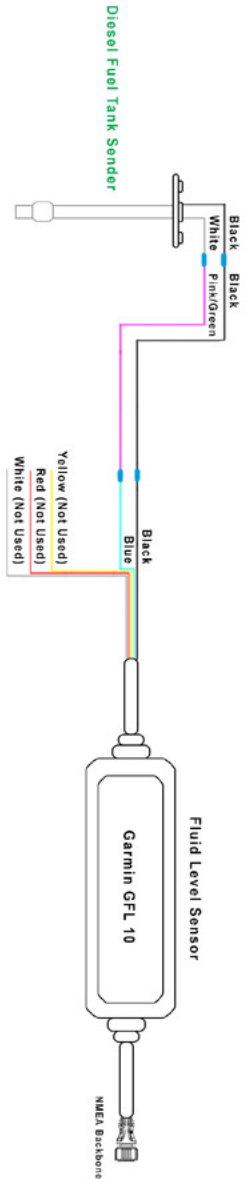
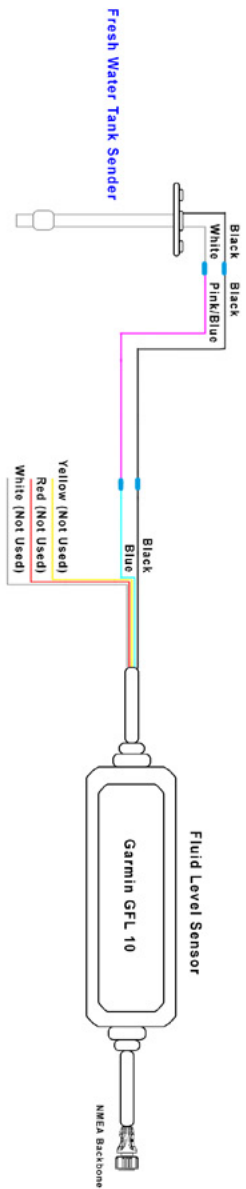
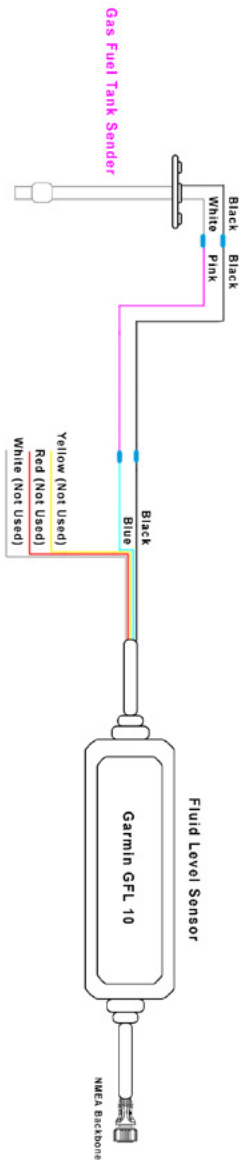

# YAMAHA HYDRAULIC STEERING NMEA NETWORK

Subject Work Instruction: VK Yamaha Optimus 360 NMEA Network	Issue Date: 04/24/2020	Rev: 0	Document No. EL-112
Approved By: Dion Colbourne	Written By: Kyle Quatman	Rev Date: ----	Page: 1 of 1

**REFERENCE ONLY 1**

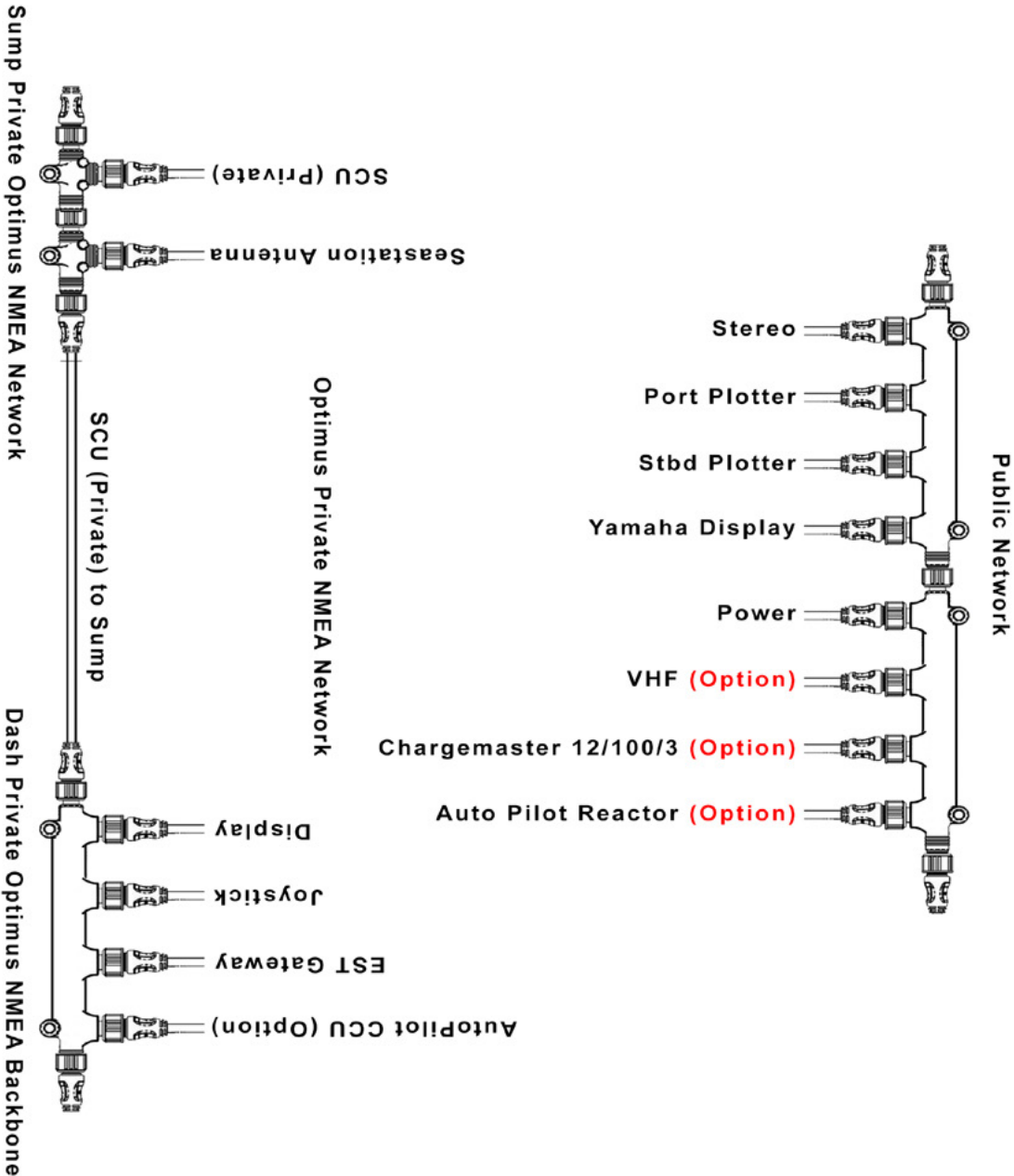



# YAMAHA HELM MASTER STEERING NMEA NETWORK

Subject Work Instruction: VK Yamaha Helm Master NMEA Network	Issue Date: 06/02/2020	Rev: 1	Document No. EL-112
Approved By: Dion Colbourne	Written By: Kyle Quatman	Rev Date: ----	Page: 1 of 1

**REFERENCE ONLY 1**

## Helm Master Auto Pilot (Option) Private Network

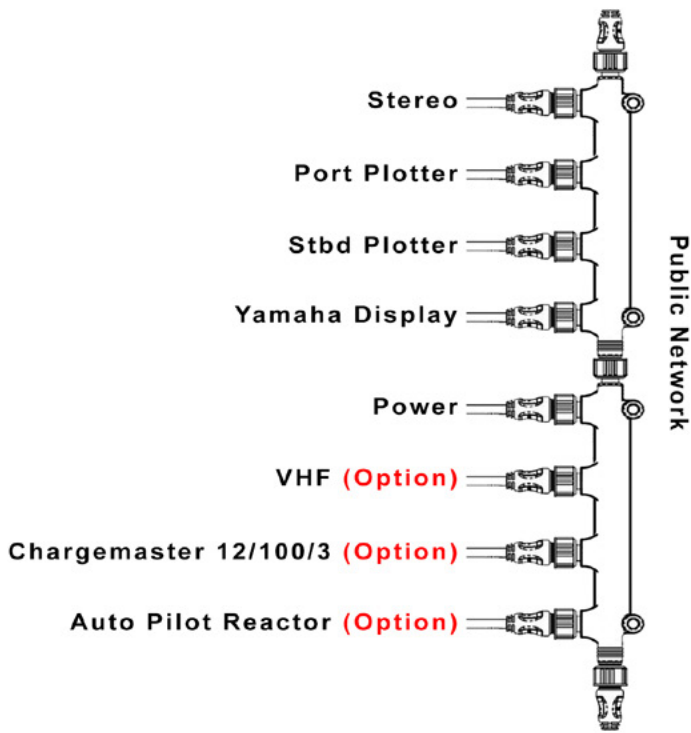
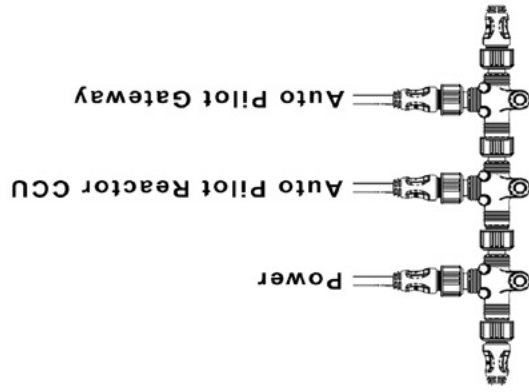

# YAMAHA HELM MASTER STEERING- OVERVIEW

Subject Work Instruction: Helm Master Overview <b>Twin Engine</b>	Issue Date: 07/21/2020	Rev: 0	Document No. EL-138
Approved By: Dion Colbourne	Written By: Kyle Quatman	Rev Date: ....	Page: 1 of 1

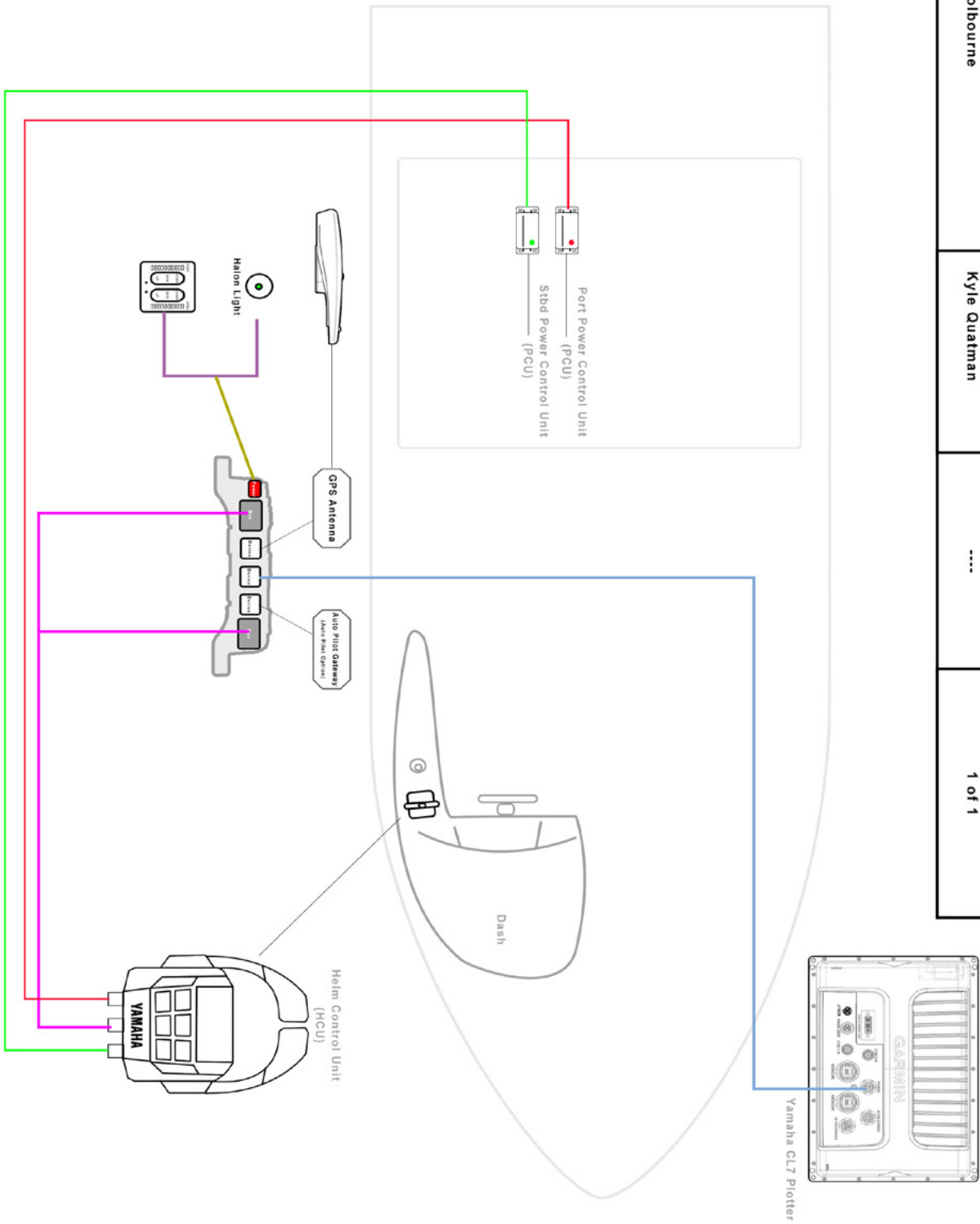

# YAMAHA HYDRAULIC STEERING SYSTEM OVERVIEW

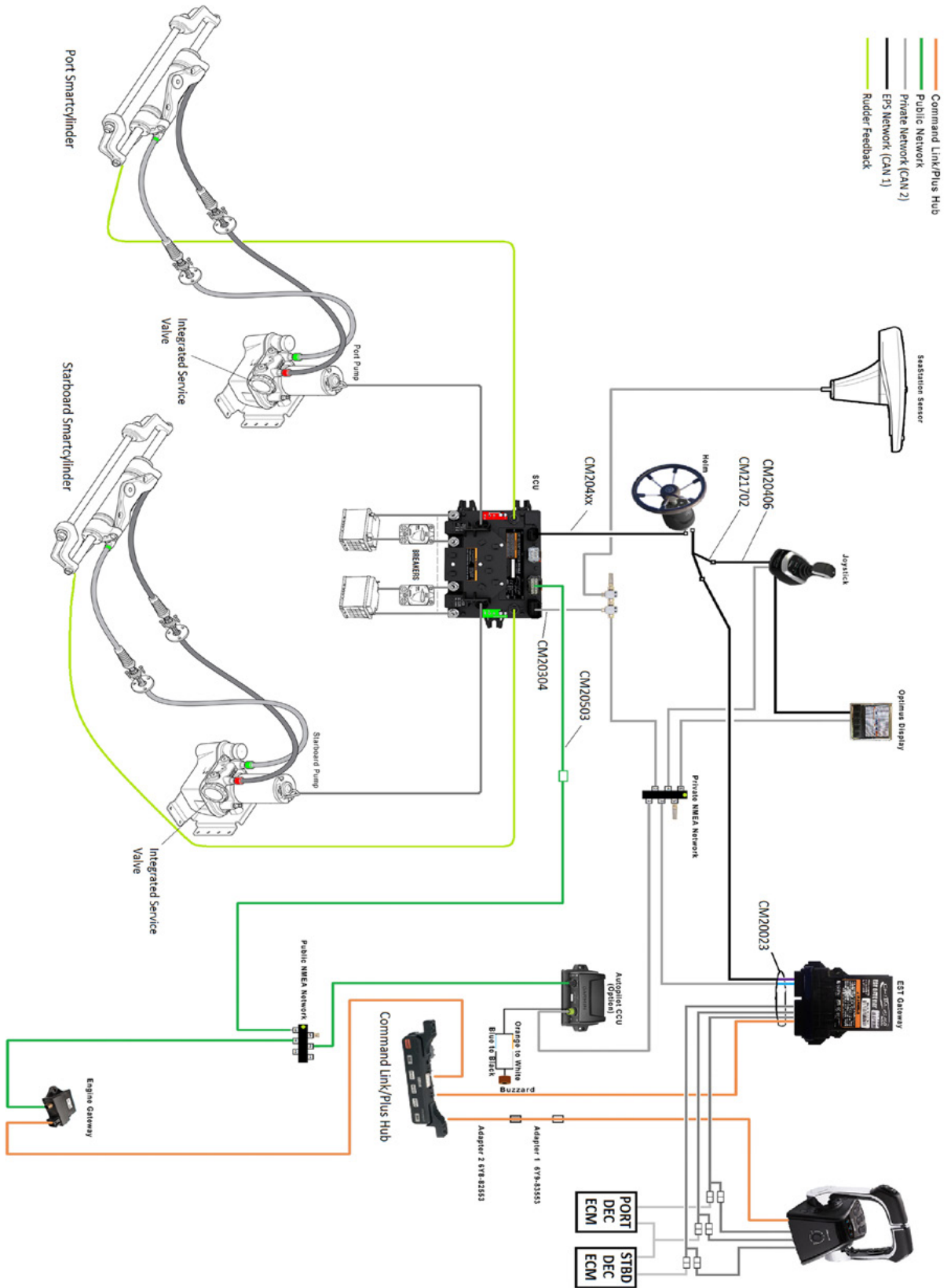

# FUEL TANK HOSE ROUTING 1

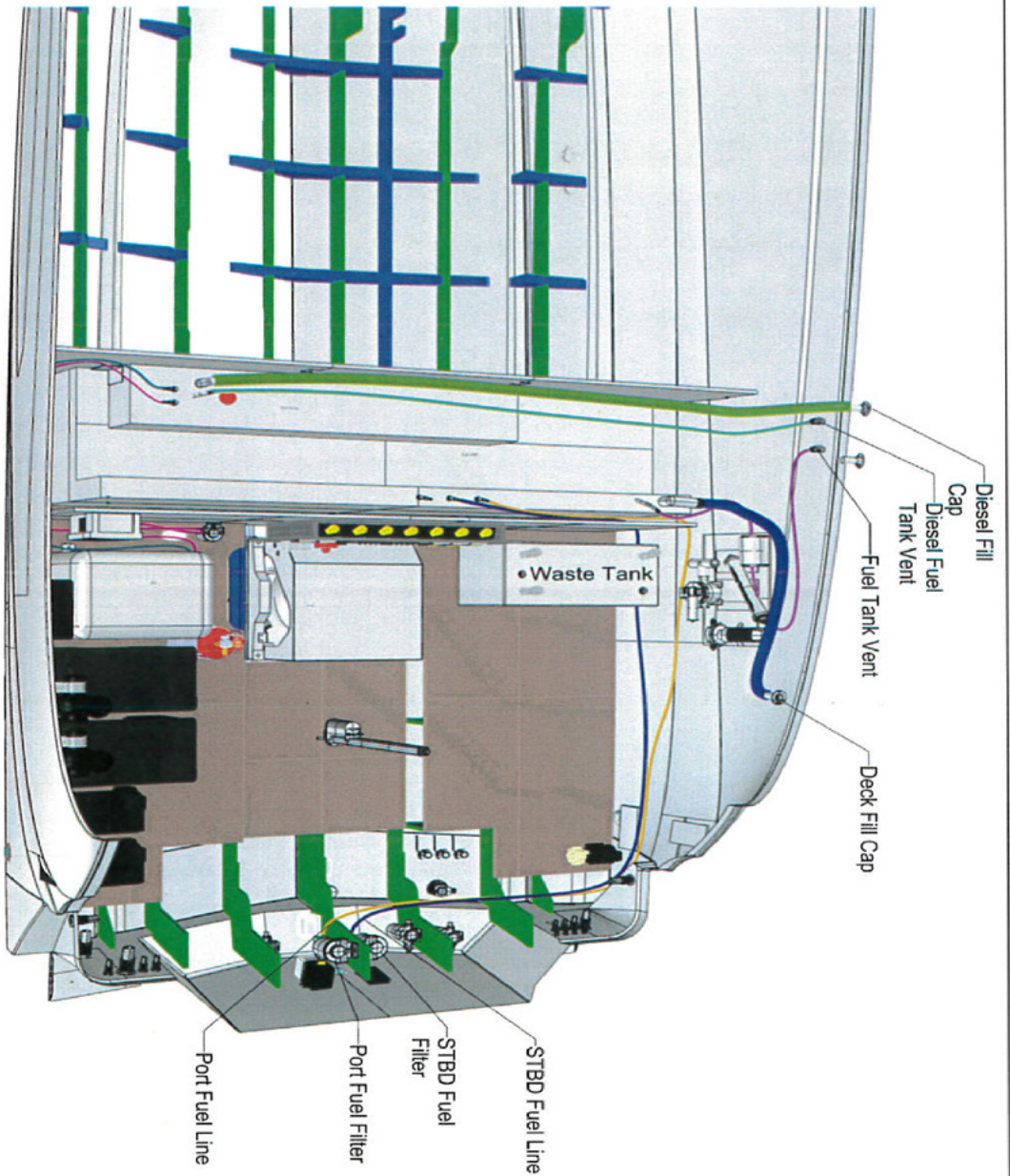

- Fuel Vent Routing 3/4" Ø  
Hose Length: 80 in
- Diesel Generator Feed 3/4" Ø  
Hose Length: 60 in
- Diesel Fuel Fill Routing 3/8" Ø  
Hose Length: 111 in
- Diesel Fuel Vent Routing 3/4" Ø  
Hose Length: 111 in
- Diesel Generator Routing 3/4" Ø  
Hose Length: 111 in
- Port Engine Fuel Routing 3/8" Ø  
Hose Length: 135 in
- STBD Engine Fuel Routing 3/8" Ø  
Hose Length: 135 in
- Fuel Fill Routing 2" Ø  
Hose Length: 60 in

FOR THE LINE AND COMPONENTS, SEE DRAWING 1 AND DRAWING 2. THE DESIGN OF THE SYSTEM IS THE PROPERTY OF REGAL MARINE INDUSTRIES. ALL RIGHTS RESERVED. THE INFORMATION AND DESIGNATION ON THIS DRAWING IS FOR INFORMATION ONLY. REGAL MARINE INDUSTRIES IS NOT RESPONSIBLE FOR THE PROPER INSTALLATION OF THIS SYSTEM. REGAL MARINE INDUSTRIES IS NOT RESPONSIBLE FOR THE PROPER INSTALLATION OF THIS SYSTEM.

<b>REGAL MARINE INDUSTRIES</b> 2000 W. 10TH AVENUE, SUITE 100 DENVER, CO 80202 TEL: (303) 751-1200			
ALL RIGHTS RESERVED			
DATE	REVISED BY	REVISED BY	REVISED BY
11/18/2019	DMC		
<b>36 XO (VK) Fuel Tank Routings</b>			
DRAWN BY		DATE	
DMC		1 OF 4	
		DWG NO. MWK23C	



# FUEL TANK HOSE ROUTING 2

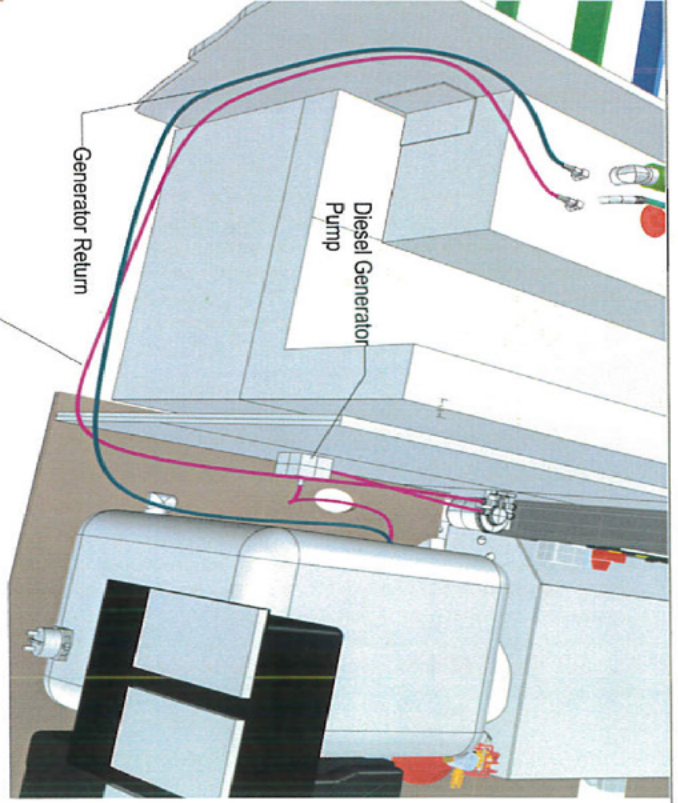
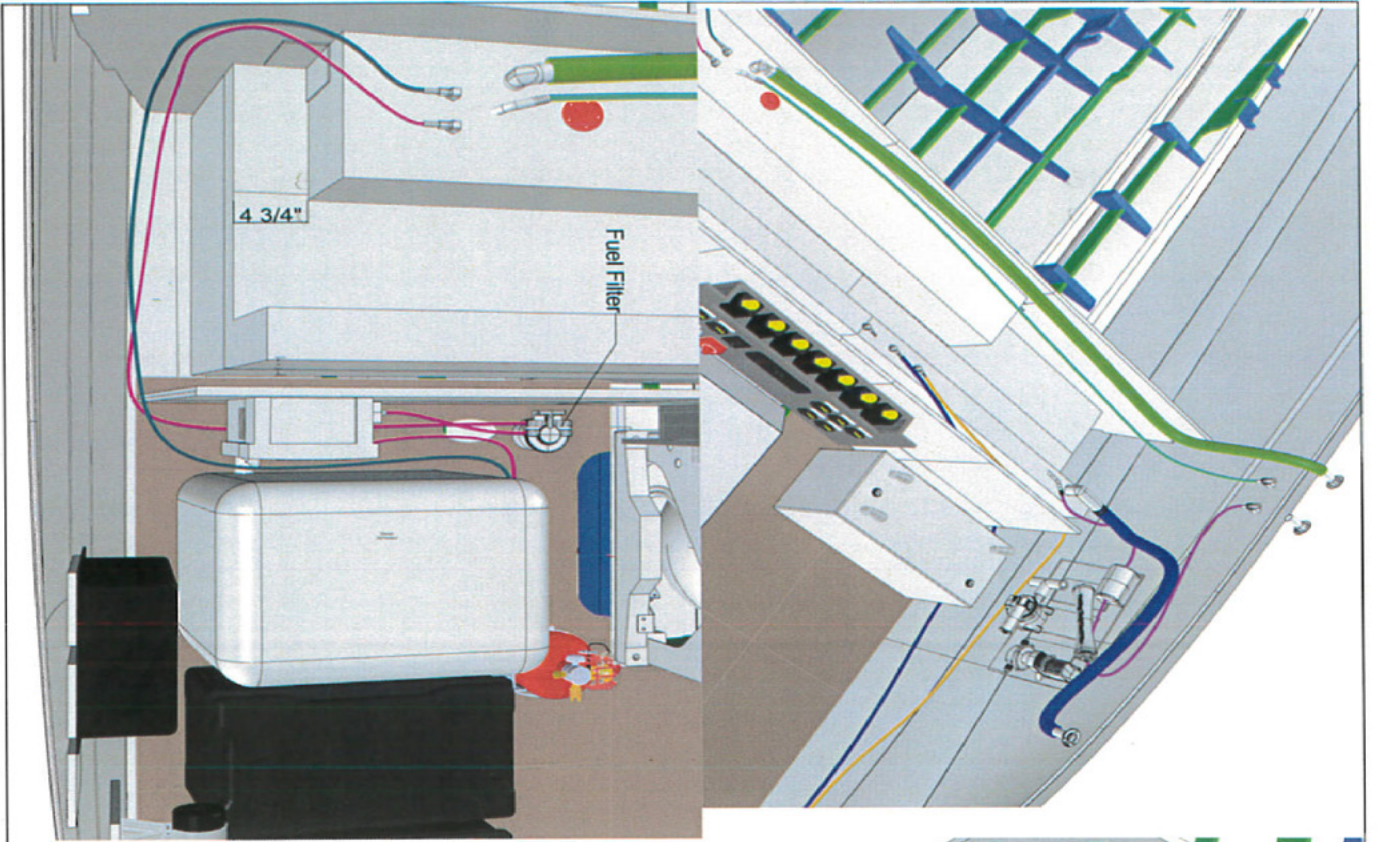

- Fuel Vent Routing 3/4" Ø  
Hose Length: 80 in
- Fuel Fill Routing 2" Ø  
Hose Length: 80 in
- Diesel Fuel Fill Routing 3/8" Ø  
Hose Length: 111 in
- Diesel Fuel Vent Routing 3/4" Ø  
Hose Length: 111 in
- Diesel Generator Feed 3/4" Ø  
Hose Length: 111 in
- Diesel Generator Routing 3/4" Ø  
Hose Length: 111 in
- Port Engine Fuel Routing 3/8" Ø  
Hose Length: 195 in
- STBD Engine Fuel Routing 3/8" Ø  
Hose Length: 195 in

PROPERTY AND DOCUMENT TITLE, THE DRAWING IS THE SOLE PROPERTY OF REGAL MARINE INDUSTRIES. ANY REPRODUCTION OR TRANSMISSION IN ANY FORM OR BY ANY MEANS WITHOUT THE WRITTEN PERMISSION OF REGAL MARINE INDUSTRIES IS PROHIBITED.

DRAWING TITLE		
<b>36 XO (VK) Fuel Tank Routings</b>		
REGAL MARINE INDUSTRIES CORPORATION (UK) LIMITED 15, WATERLOO ROAD		
ALL RIGHTS RESERVED		
DATE	REVISION	PAGE
11/18/2019	-	2 OF 4
DRAWN BY	APPROVED BY	ENG. NO.
DMC	-	MVK23C



# FUEL TANK INSTALLATION

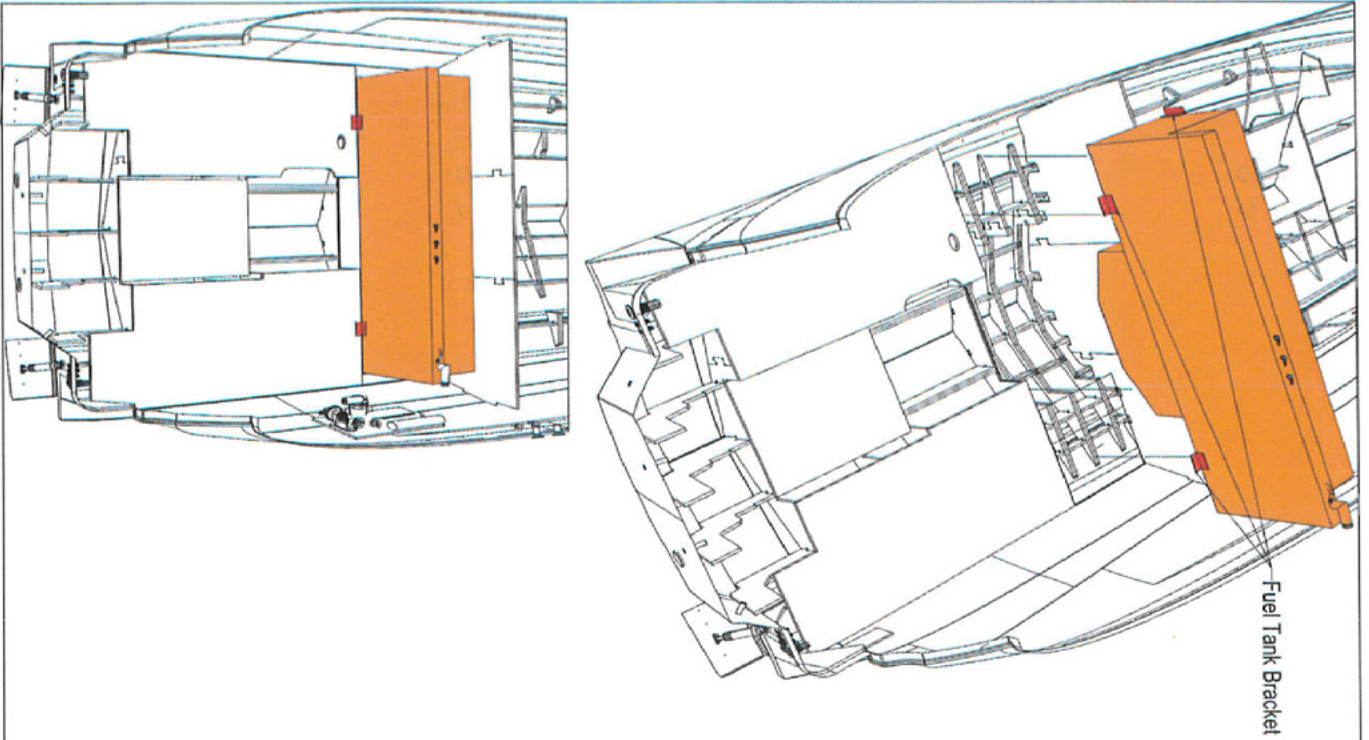

Fuel Tank Bracket

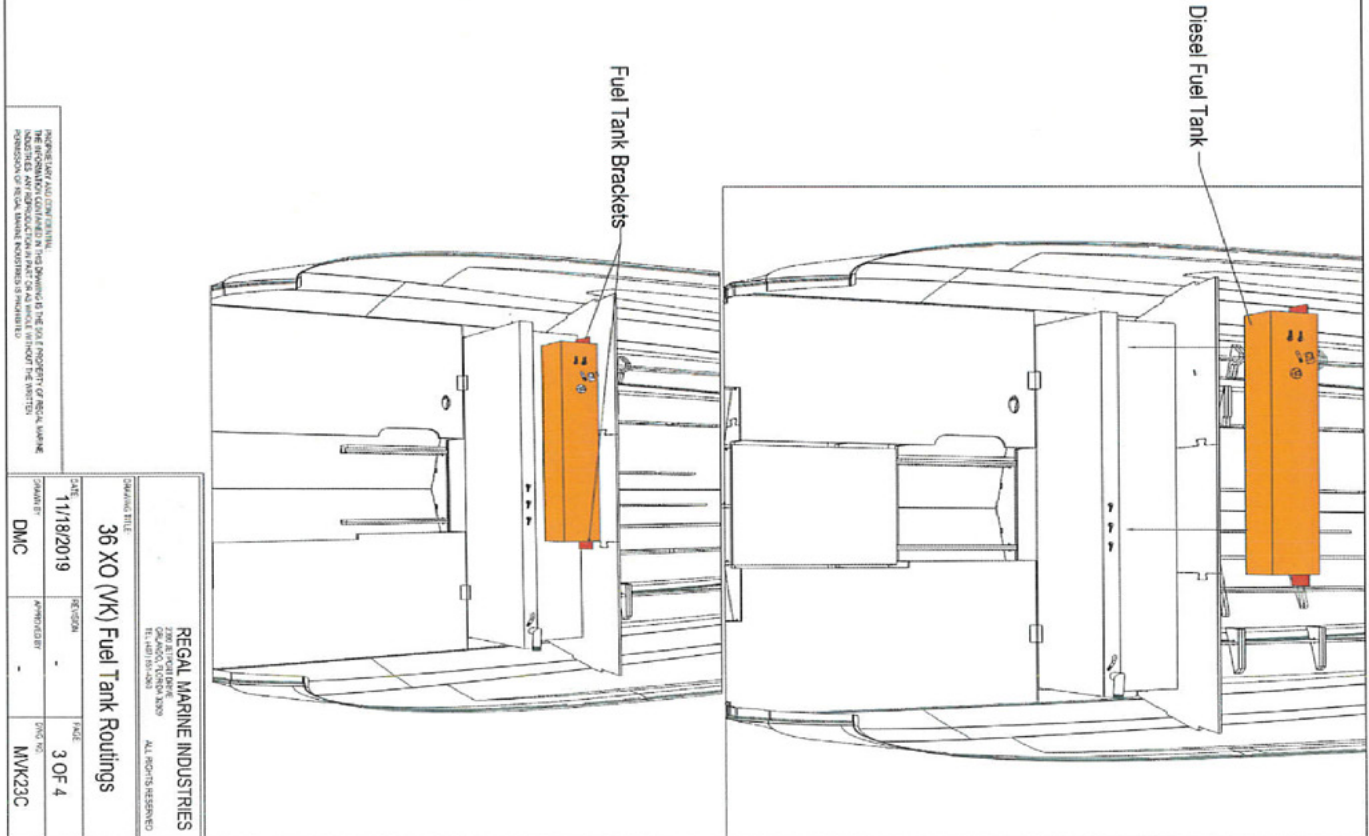

Diesel Fuel Tank

ENGINE LIFT AND COWL INSTALLATION  
 THE INFORMATION CONTAINED IN THIS DRAWING IS THE SOLE PROPERTY OF REGAL MARINE INDUSTRIES. NO PART OF THIS DRAWING IS TO BE REPRODUCED OR TRANSMITTED IN ANY FORM OR BY ANY MEANS, ELECTRONIC OR MECHANICAL, INCLUDING PHOTOCOPYING, RECORDING, OR BY ANY INFORMATION STORAGE AND RETRIEVAL SYSTEM, WITHOUT THE WRITTEN PERMISSION OF REGAL MARINE INDUSTRIES. © 2019 REGAL MARINE INDUSTRIES

REGAL MARINE INDUSTRIES 20000 WILSON AVENUE FORT WORTH, TEXAS 76150 TEL: (817) 512-1000 FAX: (817) 512-1001			
DRAWING TITLE <b>36 XO (VK) Fuel Tank Routings</b>			
DATE	REVISION	BY	CHK'D BY
11/18/2019			3 OF 4
DRAWN BY	APPROVED BY	DWG NO.	
DMC		MWK23C	

# WATER TANK HOSE ROUTING 1

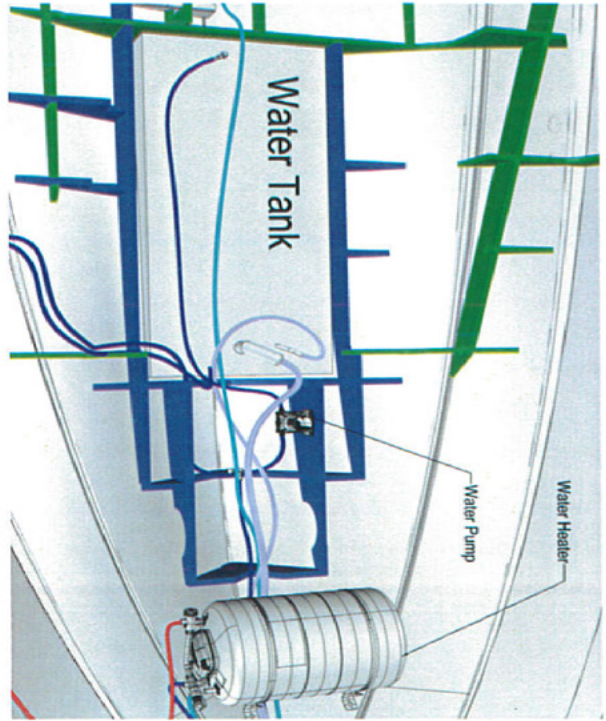

Water Tank Mounting Bracket Detail

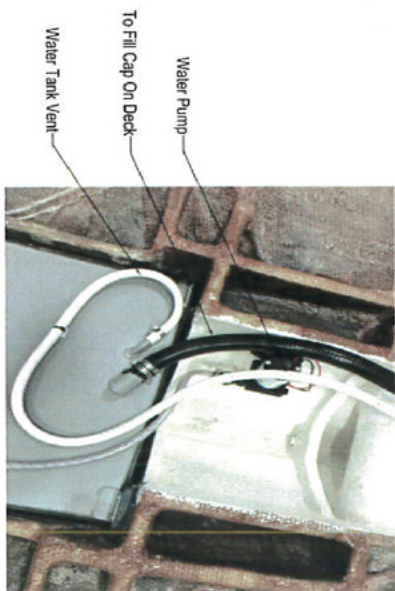
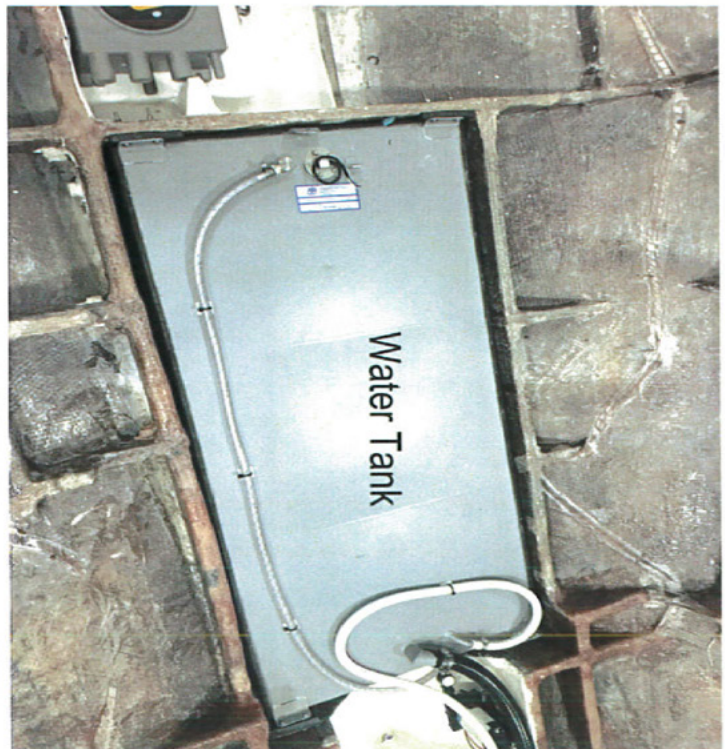
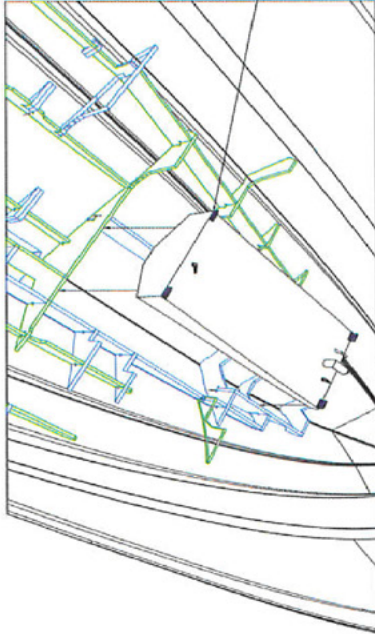
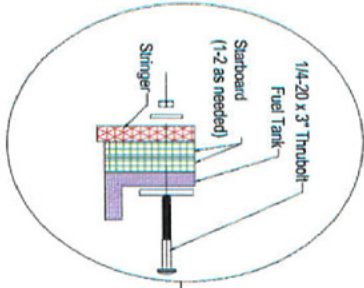

REGAL MARINE AND COASTAL, INC. THE DRAWING IS THE SOLE PROPERTY OF REGAL MARINE AND COASTAL, INC. NO PART OF THIS DRAWING IS TO BE REPRODUCED OR TRANSMITTED IN ANY FORM OR BY ANY MEANS, ELECTRONIC OR MECHANICAL, INCLUDING PHOTOCOPYING, RECORDING, OR BY ANY INFORMATION STORAGE AND RETRIEVAL SYSTEM, WITHOUT THE WRITTEN PERMISSION OF REGAL MARINE AND COASTAL, INC.

DRAWING TITLE		REGAL MARINE INDUSTRIES 36 XO Water Tank Routings	
DATE	REVISION	PAGE	ALL RIGHTS RESERVED
11/27/19		1 OF 2	
DRAWN BY	APPROVED BY	DATE	
DMC		MMK23F	



# WATER TANK HOSE ROUTING 2

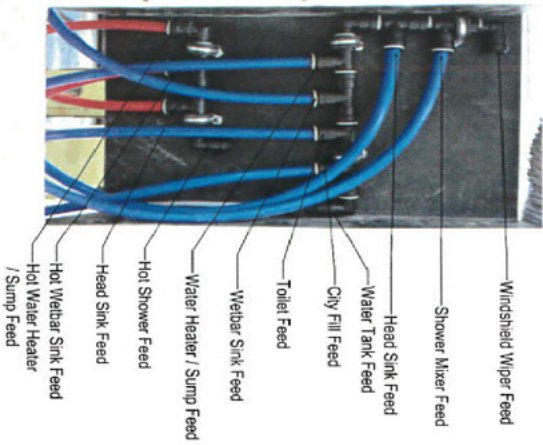
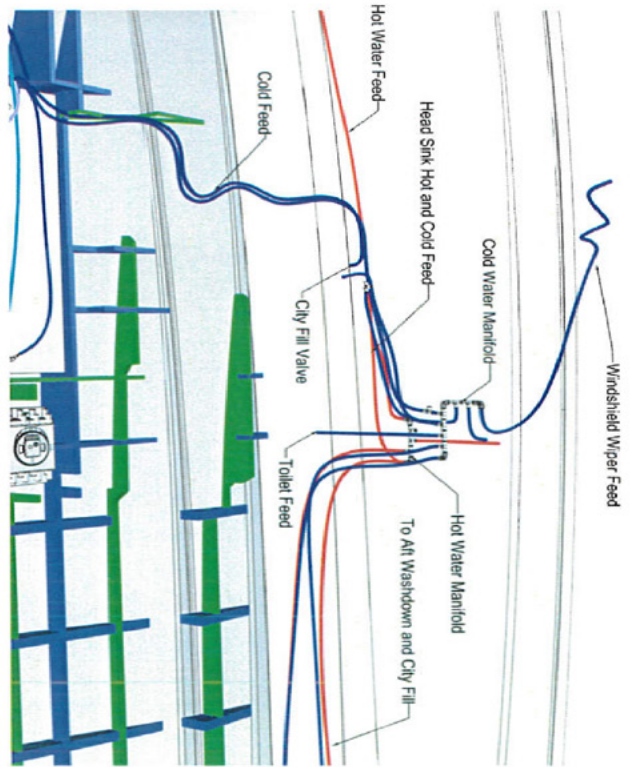
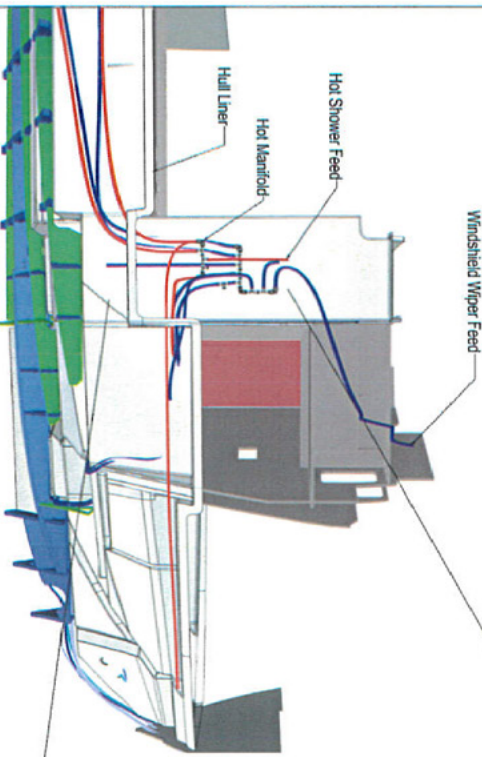
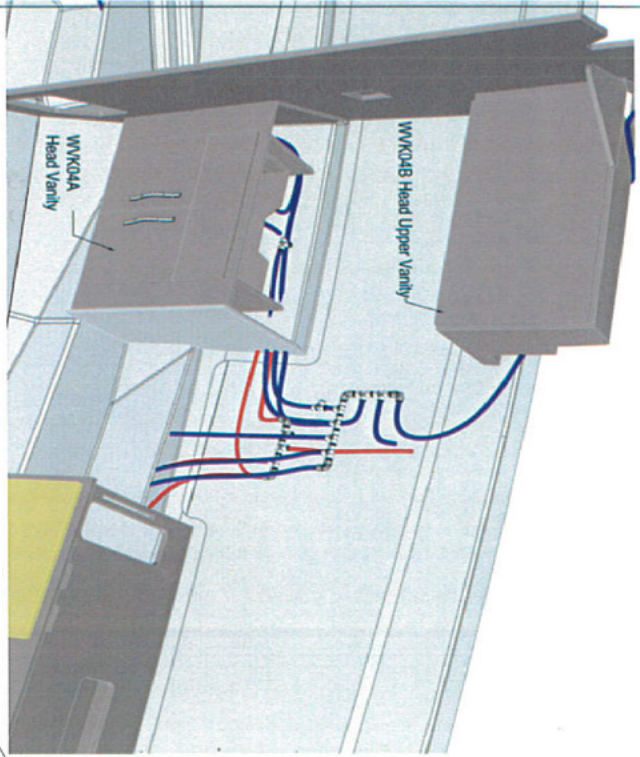

REGAL MARINE INDUSTRIES  
 36 XO Water Tank Routings  
 DATE: 11/27/19  
 DRAWN BY: DMC  
 CHECKED BY: JPS/6/23/19  
 SCALE: 1 OF 2  
 SHEET NO: MWK23F

REGAL MARINE INDUSTRIES			
36 XO Water Tank Routings			
DATE:	11/27/19	CHECKED BY:	JPS/6/23/19
DRAWN BY:	DMC	SCALE:	1 OF 2
SHEET NO:		MWK23F	

# WATER TANK HOSE ROUTING 3

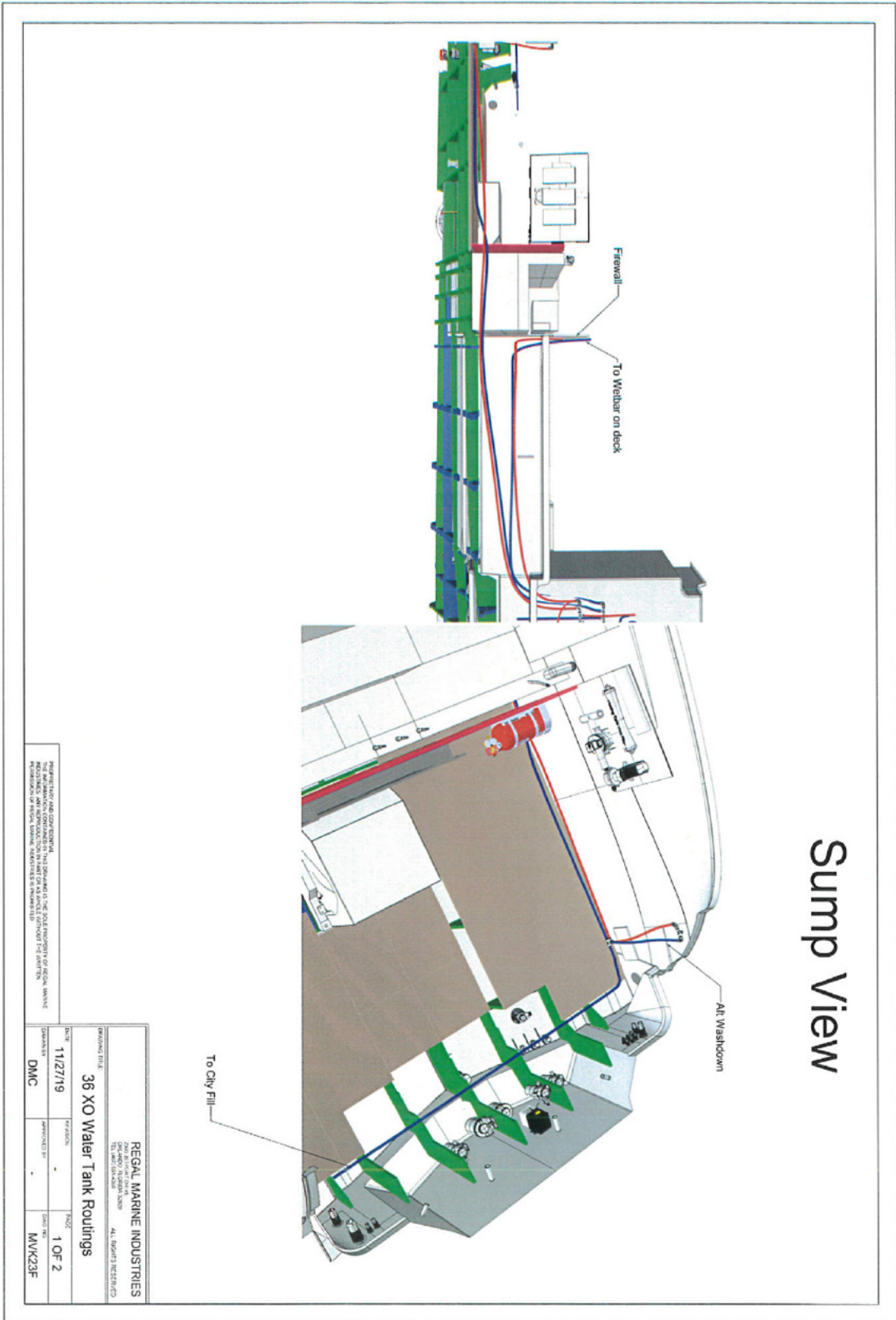



# WASTE TANK HOSE ROUTING

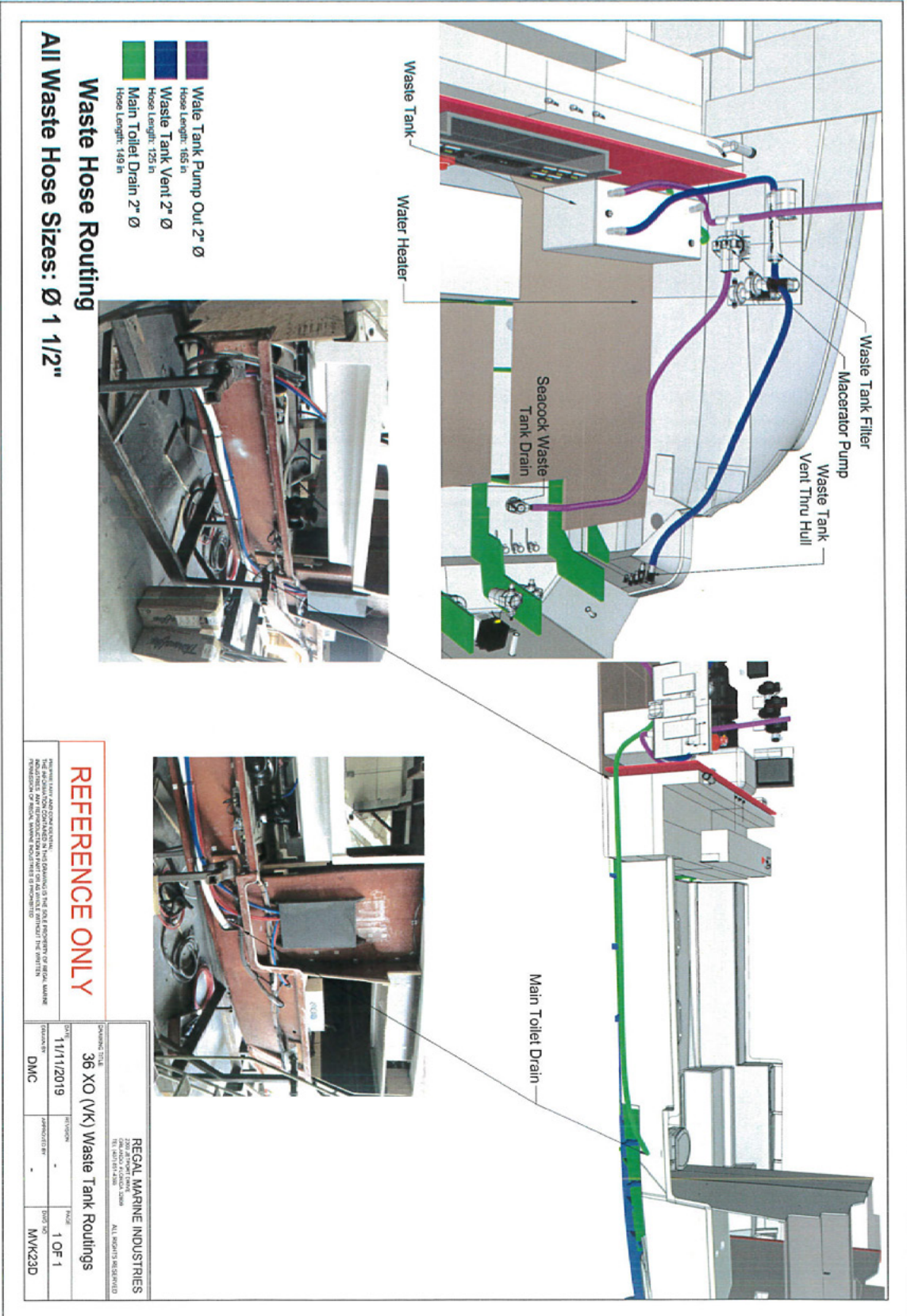



# AC HOSE ROUTING 1

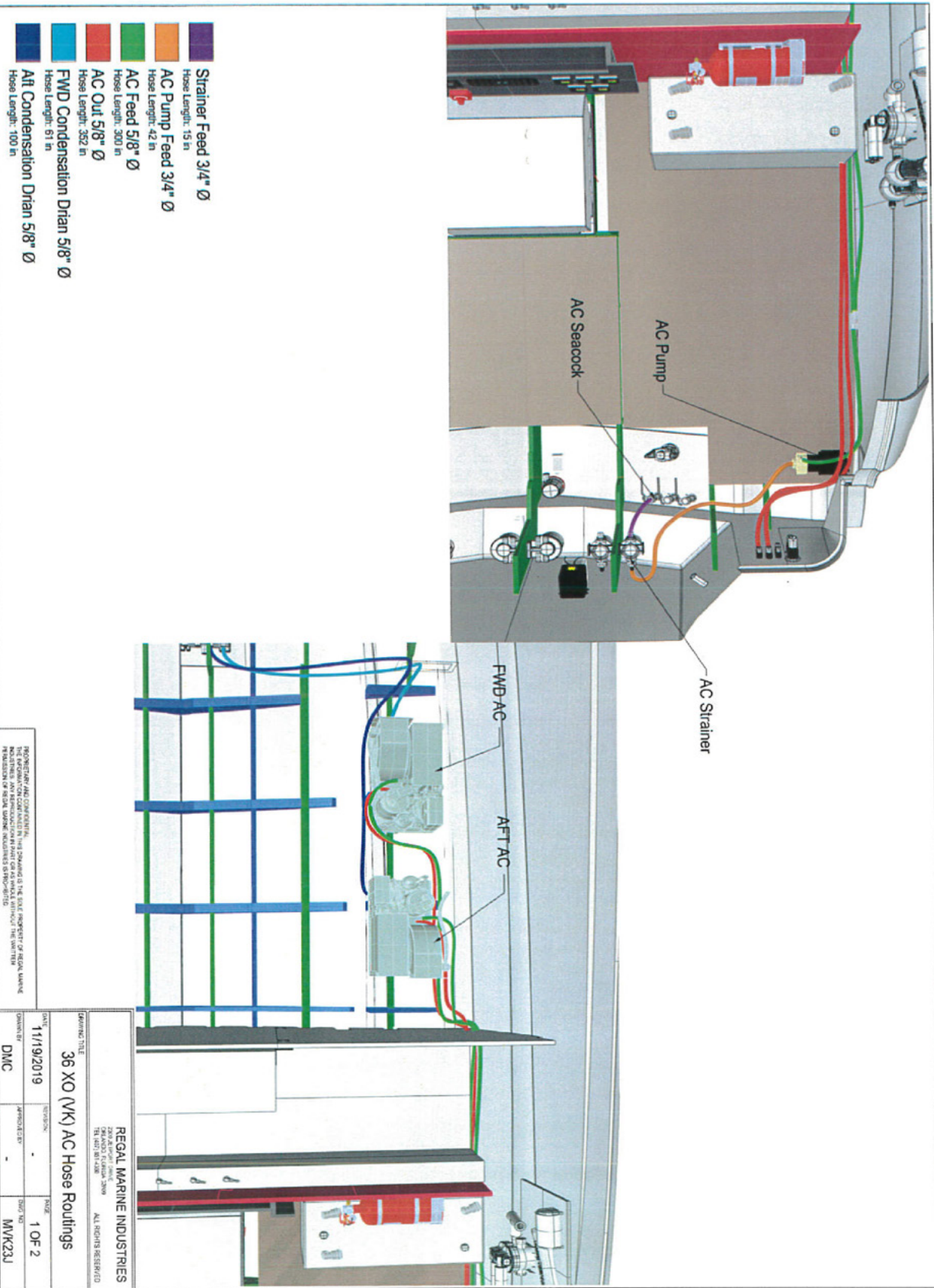

REGAL MARINE INDUSTRIES  
 2200 S. GARDNER ST. #100  
 TAMPA, FL 33629  
 TEL: 813.834.1234  
 FAX: 813.834.1235  
 WWW.REGALMARINE.COM

REGAL MARINE INDUSTRIES 2200 S. GARDNER ST. #100 TAMPA, FL 33629 TEL: 813.834.1234 FAX: 813.834.1235 WWW.REGALMARINE.COM			
DATE:	11/19/2019	REVISED:	-
DESIGNED BY:	DMC	SIZE:	1 OF 2
DRAWING TITLE		36 XO (VK) AC Hose Routings	
DRAWING NO.		MVK23J	

# AC HOSE ROUTING 2

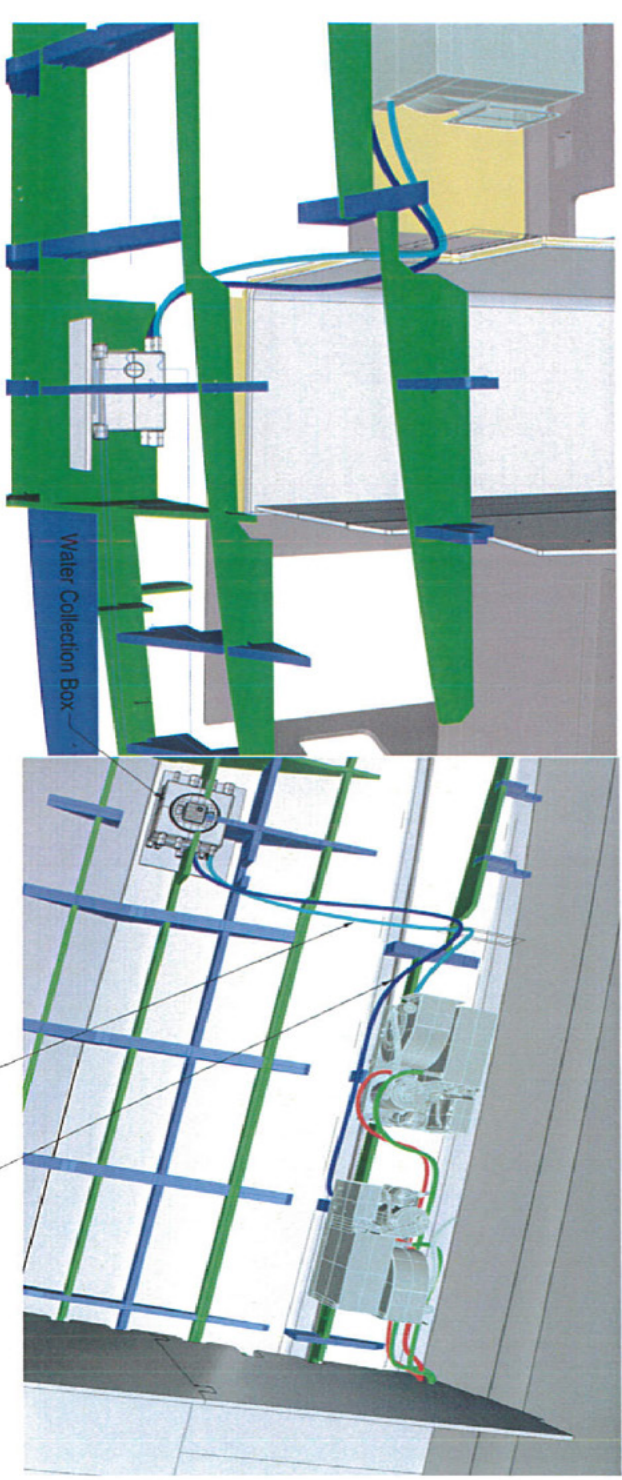
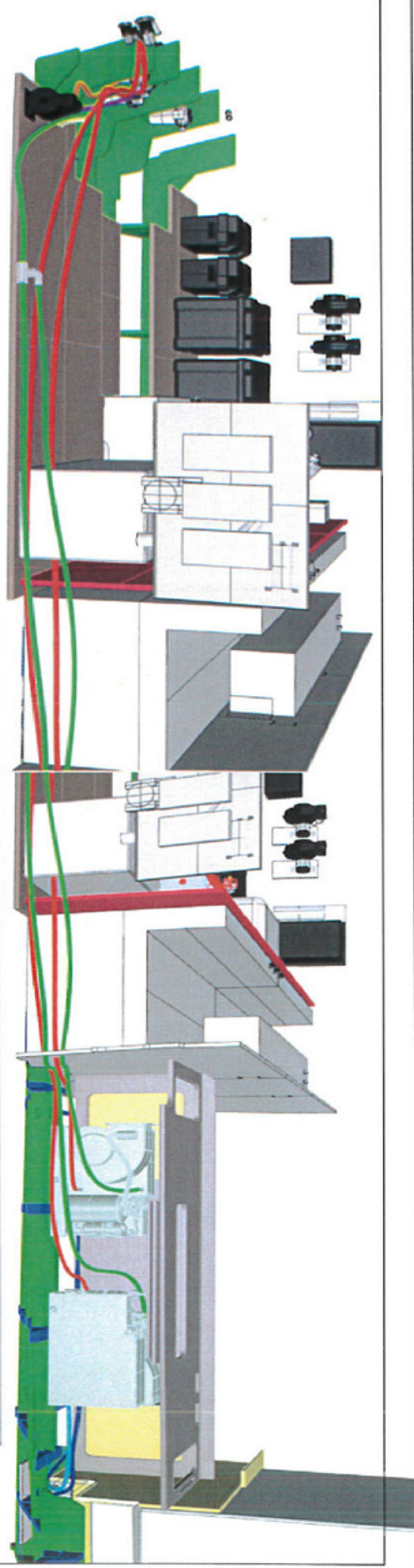

- Strainer Feed 3/4" Ø  
Hose Length: 15 in
- AC Pump Feed 3/4" Ø  
Hose Length: 42 in
- AC Feed 5/8" Ø  
Hose Length: 300 in
- AC Out 5/8" Ø  
Hose Length: 352 in
- FWD Condensation Drian 5/8" Ø  
Hose Length: 61 in
- Aft Condensation Drian 5/8" Ø  
Hose Length: 100 in

Water Collection Box

FWD Condensation Drain  
Aft Condensation Drain

REGAL MARINE AND CONSULTING  
THE INFORMATION CONTAINED IN THIS DRAWING IS THE SOLE PROPERTY OF REGAL MARINE  
INDUSTRIES. NO PART OF THIS DRAWING IS TO BE REPRODUCED OR TRANSMITTED IN ANY FORM OR BY ANY MEANS  
WITHOUT THE WRITTEN PERMISSION OF REGAL MARINE INDUSTRIES OR REGAL MARINE LTD.

DRAWING TITLE <b>36 XO (VK) AC Hose Routings</b>			
REGAL MARINE INDUSTRIES 2000 ALBERTA DRIVE FORT WORTH, TEXAS 76116 TEL: (817) 511-1600 FAX: (817) 511-1601 ALL RIGHTS RESERVED			
DATE:	DESIGNER:	SCALE:	
11/19/2019	JAMES W. ESTER	2 OF 2	
DRAWN BY:	CHECKED BY:	DATE:	
DMC		MMV23J	



# COCKPIT DRAIN HOSE ROUTING 1

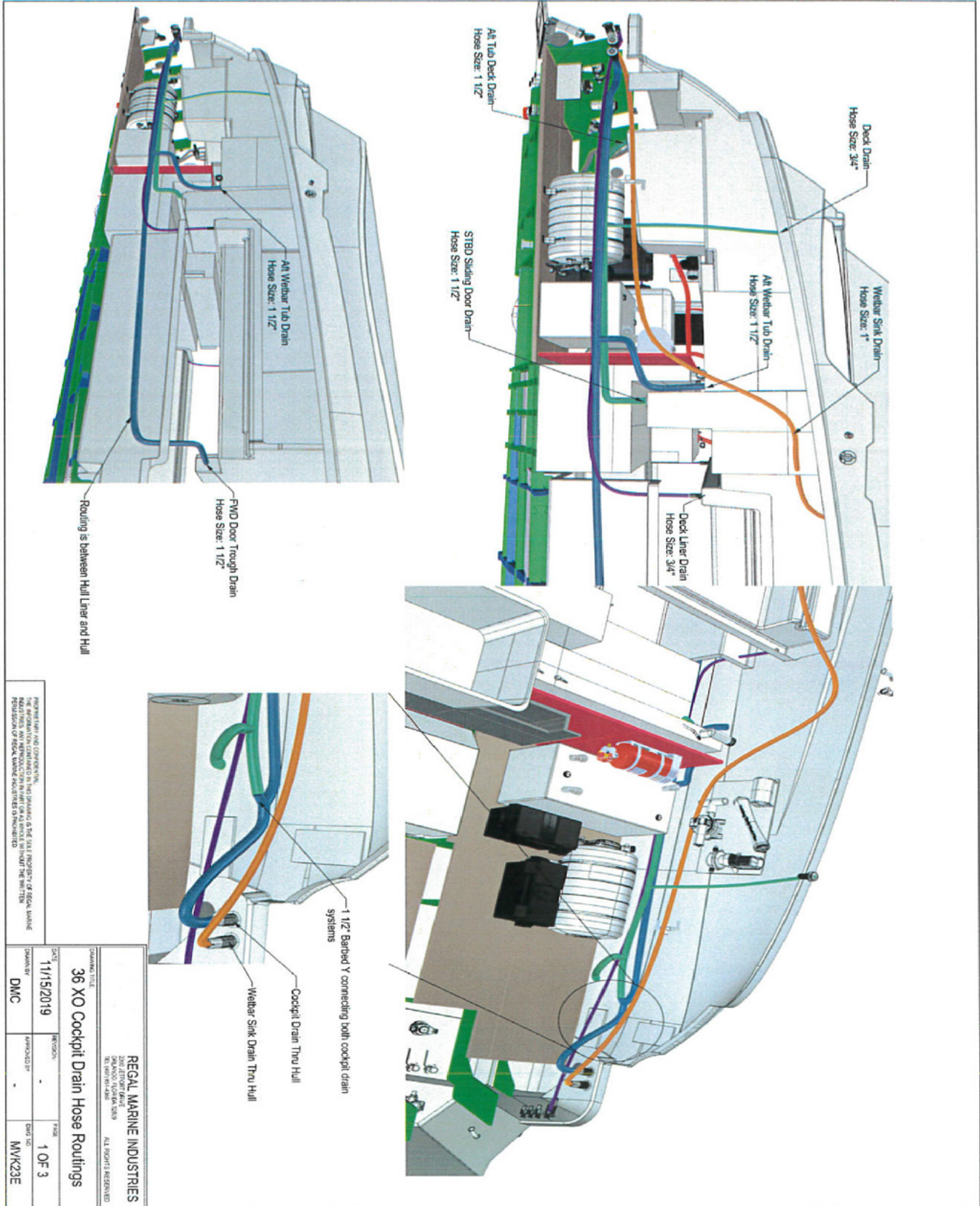

REGAL MARINE AND COOPERATION, THE INFORMATION CONTAINED IN THIS DRAWING IS THE SOLE PROPERTY OF REGAL MARINE. REPRODUCTION OR TRANSMISSION OF THIS INFORMATION WITHOUT THE WRITTEN PERMISSION OF REGAL MARINE IS PROHIBITED.

DRAWING TITLE		REGAL MARINE INDUSTRIES	
36 XO Cockpit Drain Hose Routings		3600 E. FORT DRIVE DENVER, COLORADO 80202 TEL: 303.733.8888	
DATE	REV. NO.	DATE	REV. NO.
11/15/2019	-	1 OF 3	-
DRAWN BY	APPROVED BY	DATE	REV. NO.
DMC	-	MW/K23E	-



# COCKPIT DRAIN HOSE ROUTING 2

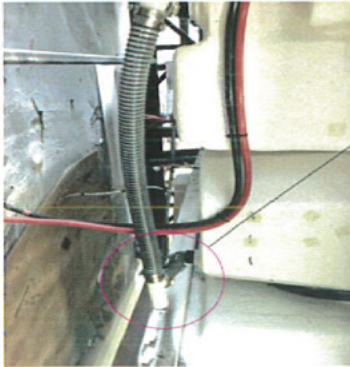
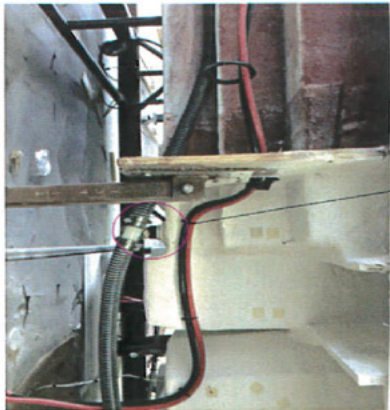
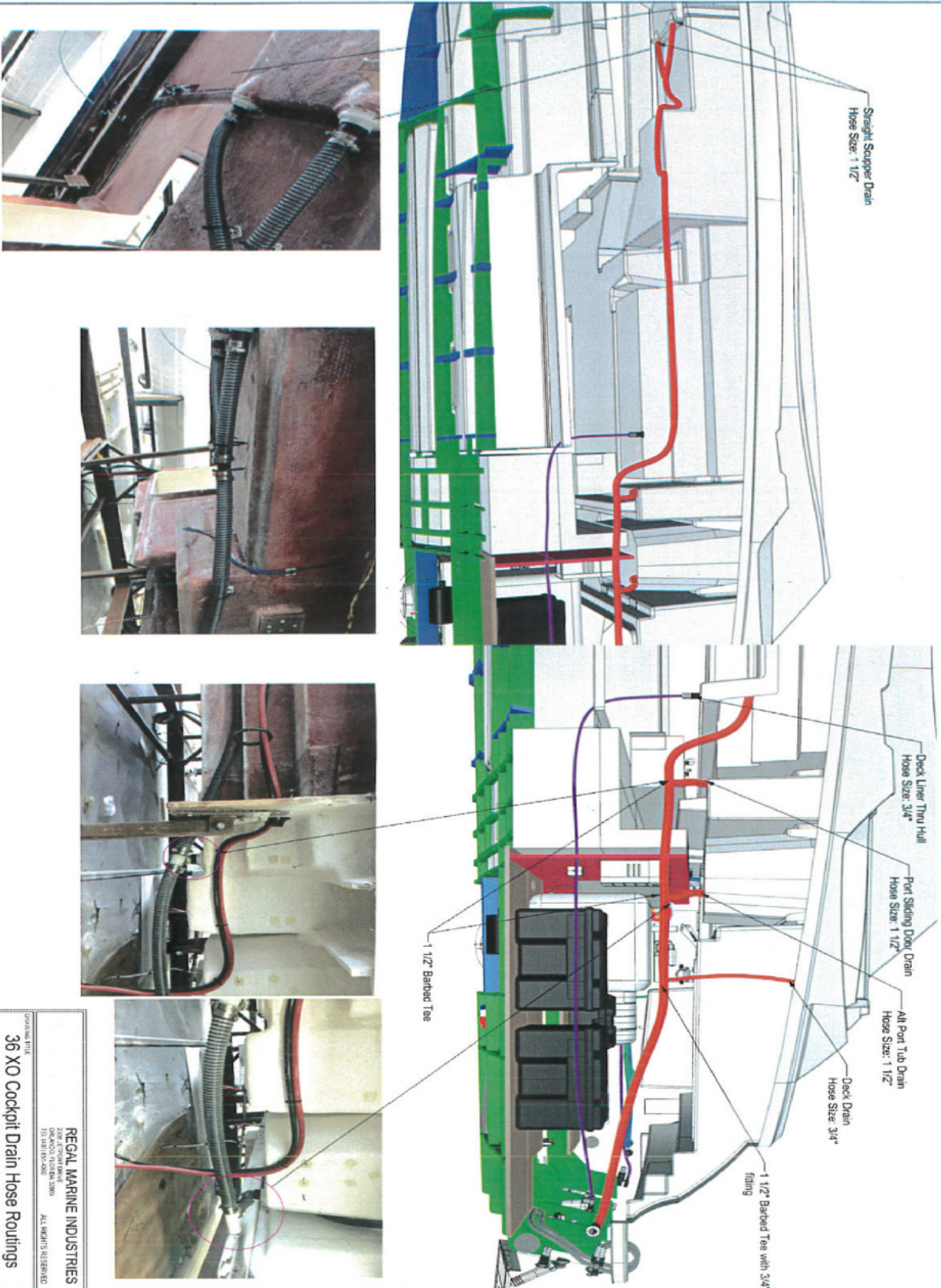

REGAL MARINE INDUSTRIES  
 THE INFORMATION CONTAINED HEREIN IS PROVIDED AS THE SOLE PROPERTY OF REGAL MARINE INDUSTRIES. THE INFORMATION CONTAINED HEREIN IS PROVIDED AS IS. REGAL MARINE INDUSTRIES IS NOT RESPONSIBLE FOR ANY DAMAGE TO PROPERTY OR PERSONS ARISING FROM THE USE OF THIS INFORMATION.

REGAL MARINE INDUSTRIES 10000 100th Avenue NW Everett, WA 98203 TEL: 425-336-4400 FAX: 425-336-4401			
REGAL MARINE INDUSTRIES ALL RIGHTS RESERVED			
DATE:	REVISED:	REVISED BY:	REVISED NO:
11/15/2019			2 OF 3
PROJECT NO:	PROJECT NAME:	PROJECT NO:	PROJECT NO:
DMC			MVK23E



# COCKPIT DRAIN HOSE ROUTING 3

## Bow Cockpit Drains



1/2" Scupper Drain  
90° Elbow

1/2" Scupper Drain  
90° Elbow

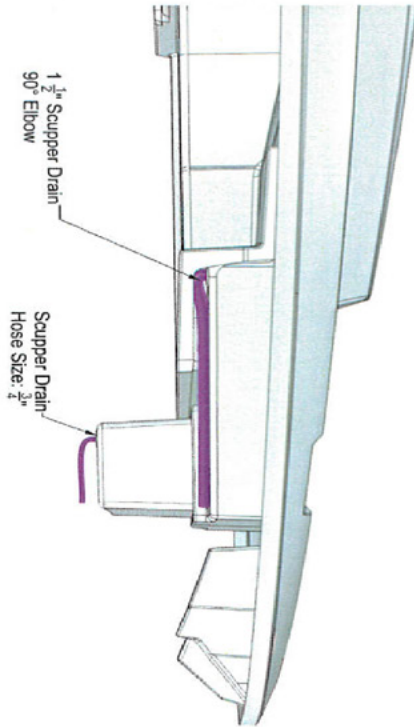

1/2" Scupper Drain  
90° Elbow

Scupper Drain  
Hose Size: 1/2"

REGAL MARINE INDUSTRIES  
REGAL MARINE INDUSTRIES IS THE SOLE IMPORTER OF REGAL MARINE  
EQUIPMENT AND REPLICATION IN PART OR AS WHOLE WITHOUT THE WRITTEN  
PERMISSION OF REGAL MARINE INDUSTRIES IS PROHIBITED

REGAL MARINE INDUSTRIES 20000 WILSON AVENUE SUITE 100, VANUVER, BC V2V 3X9 TEL: 604.731.8888			
ALL RIGHTS RESERVED			
DRAWING TITLE <b>36 SC (VJ) Cockpit Drain Hose Routings</b>	DATE 11/15/2019	REVISION -	PAGE 3 OF 3
DRAWN BY DMC	APPROVED BY -	DATE: 11/15/2019	DRAWN BY: MWK23E

# COLLECTION BOX HOSE ROUTING 1

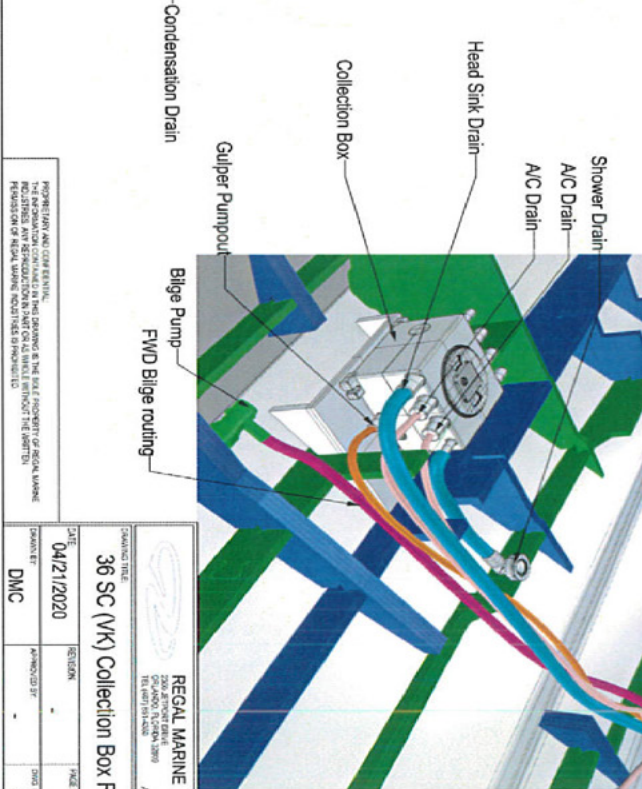
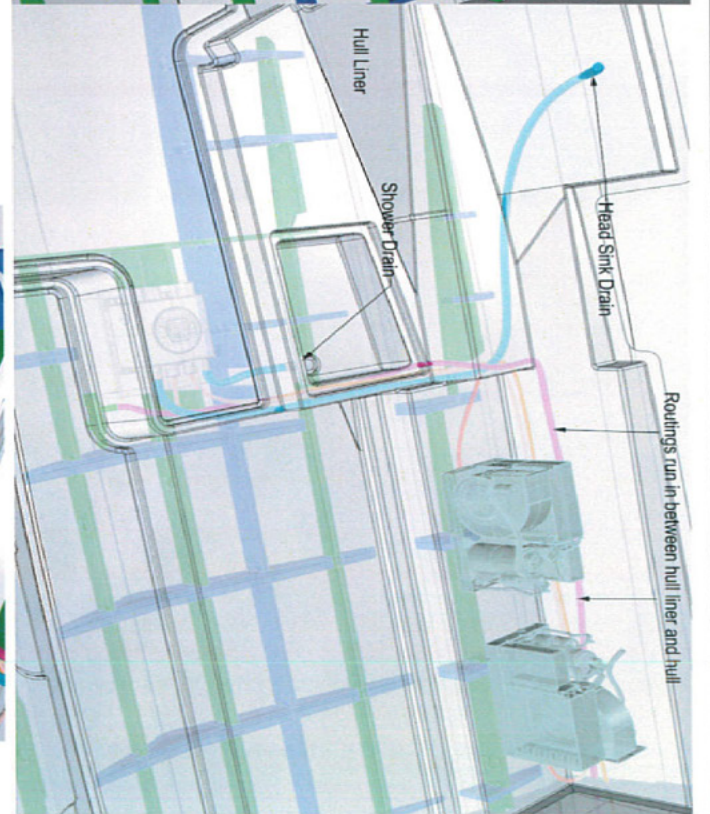
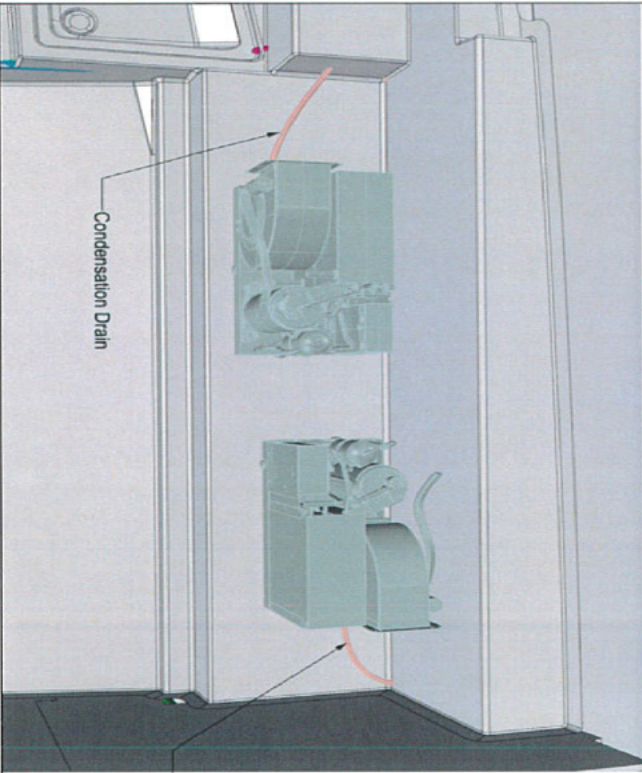
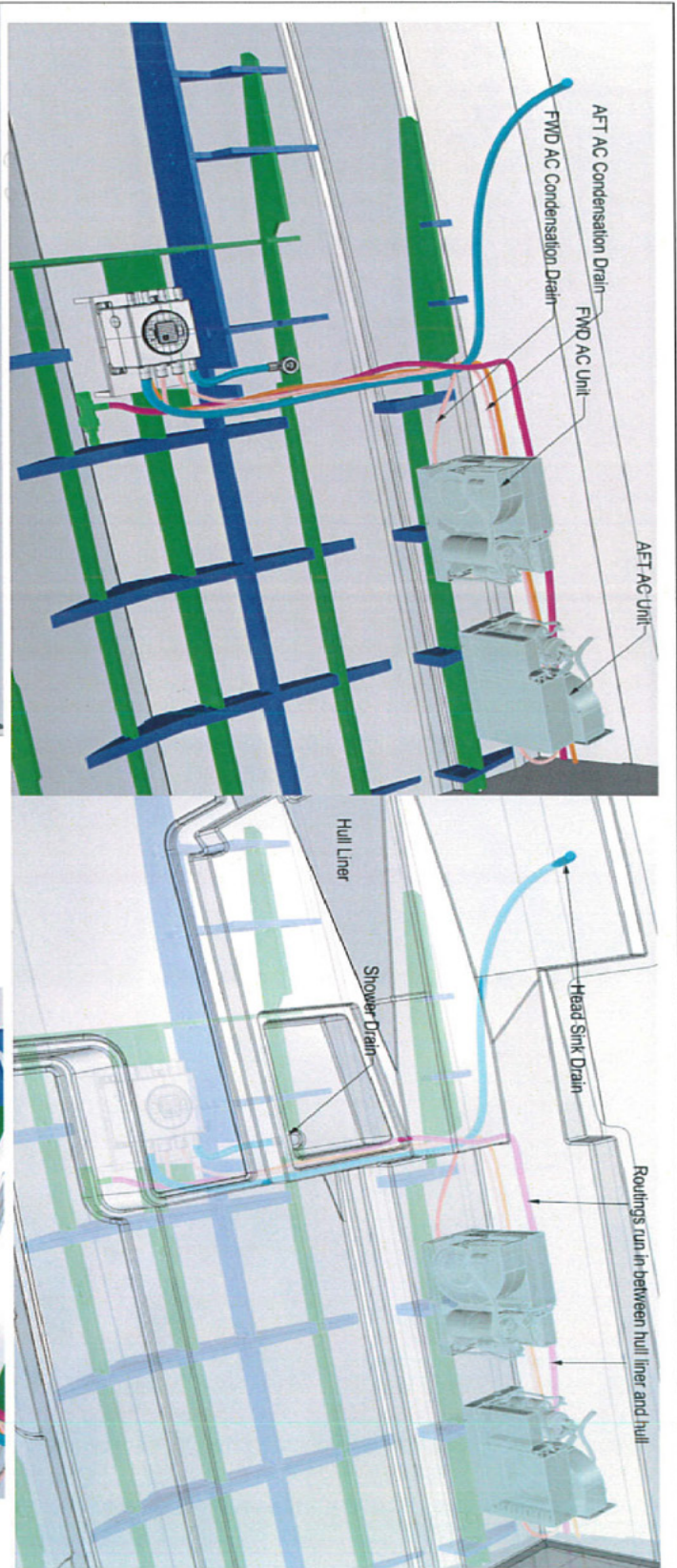

ENGINEERING AND DESIGN  
 THE INFORMATION CONTAINED ON THIS DRAWING IS THE PROPERTY OF REGAL MARINE INDUSTRIES. NO REPRODUCTION OR TRANSMISSION OF THIS DRAWING IN ANY FORM OR BY ANY MEANS, ELECTRONIC OR MECHANICAL, INCLUDING PHOTOCOPYING, RECORDING, OR BY ANY INFORMATION STORAGE AND RETRIEVAL SYSTEM, IS PERMITTED WITHOUT THE WRITTEN PERMISSION OF REGAL MARINE INDUSTRIES. REVISED

DRAWING TITLE		REGAL MARINE INDUSTRIES 36 SC (V/K) Collection Box Routings	
DATE	04/21/2020	REGION	1 OF 2
DRAWN BY	DMC	APPROVED BY	MMK23H
SHEET NO.		2025 001	



# COLLECTION BOX HOSE ROUTING 2

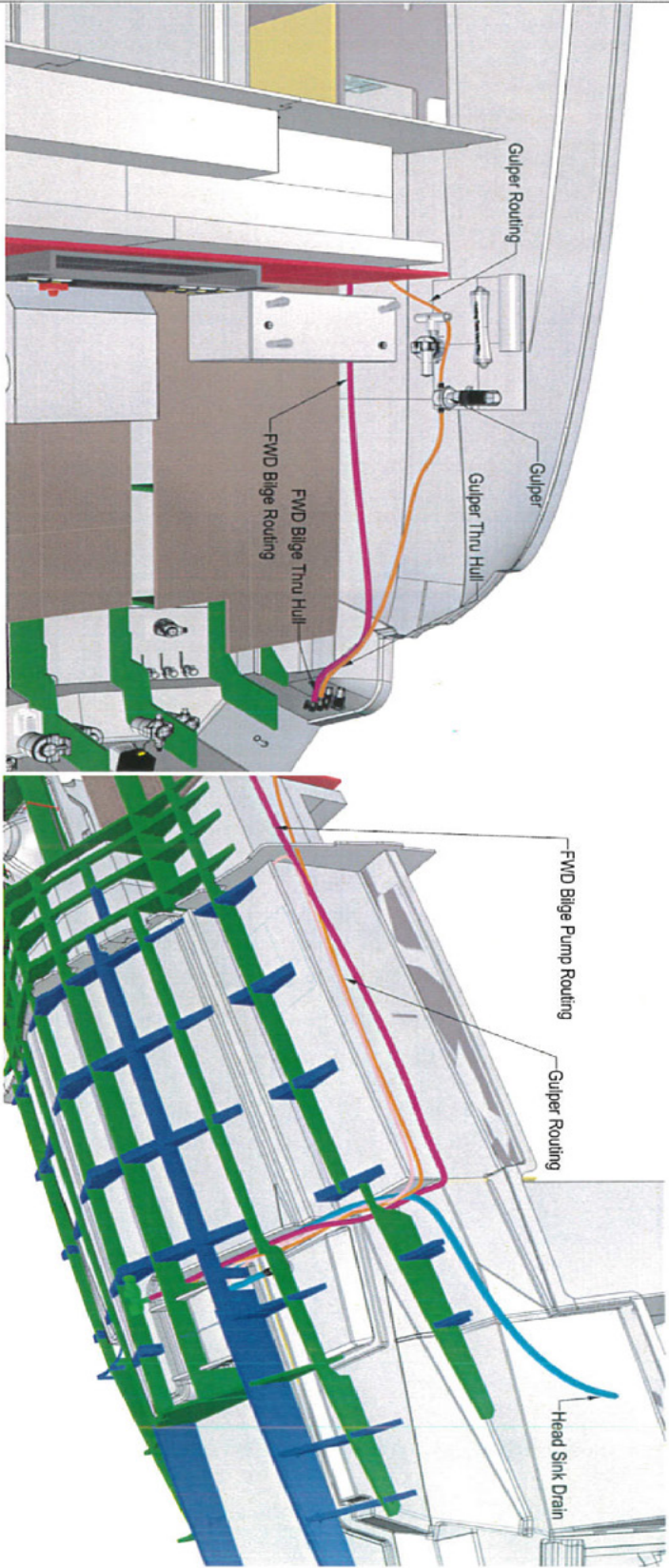

REGAL MARINE INDUSTRIES, INC. HAS CONDUCTED THE VISUAL VERIFICATION OF THIS HOSE ROUTING. REGAL MARINE INDUSTRIES DOES NOT WARRANT THE ACCURACY OF THIS HOSE ROUTING. REGAL MARINE INDUSTRIES IS NOT RESPONSIBLE FOR ANY DAMAGE TO THE VESSEL OR PERSONS OR PROPERTY CAUSED BY THE USE OF THIS HOSE ROUTING. REGAL MARINE INDUSTRIES IS NOT RESPONSIBLE FOR ANY DAMAGE TO THE VESSEL OR PERSONS OR PROPERTY CAUSED BY THE USE OF THIS HOSE ROUTING.

<p>REGAL MARINE INDUSTRIES                  28400 N. US HWY 101, SUITE 100                  BOCA RATON, FL 33433                  TEL: 561-993-9300</p>		<p>ALL RIGHTS RESERVED</p>	
<p><b>36 SC (WK) Collection Box Routings</b></p>			
DATE	REVISION	NO.	REV.
04/21/2020		2	OF 2
DESIGN BY	APPROVED BY	SHEET NO.	
DMC		MVK23H	

# SUMP (BILGE) LAYOUT 1

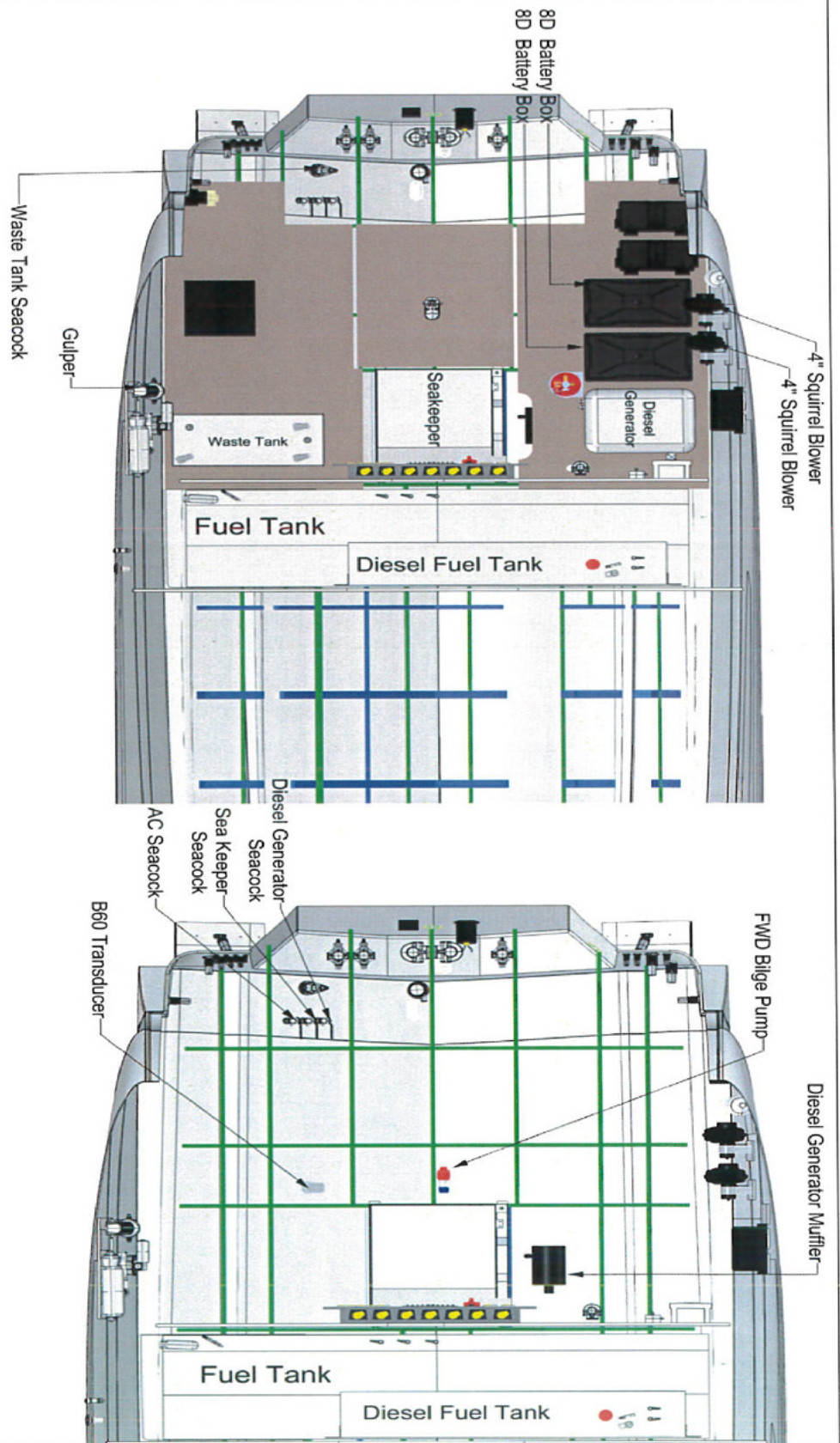

PROPRIETARY AND CONFIDENTIAL. THIS DRAWING IS THE PROPERTY OF REGAL MARINE INDUSTRIES. NO REPRODUCTION OR TRANSMISSION IN ANY FORM OR BY ANY MEANS, WITHOUT THE WRITTEN PERMISSION OF REGAL MARINE INDUSTRIES IS FORWARDED.

DRAWING TITLE		REGAL MARINE INDUSTRIES	
36 XO (VK) Sump Layout		CORVALLON, COLORADO, 2800	
DATE		TEL: 970.831.4266	
12/05/2019		ALL RIGHTS RESERVED	
DRAWN BY	REVISION	DATE	NO.
DMC	*	1 OF 5	
APPROVED BY		DWG NO.	MW/238



# SUMP (BILGE) LAYOUT 2

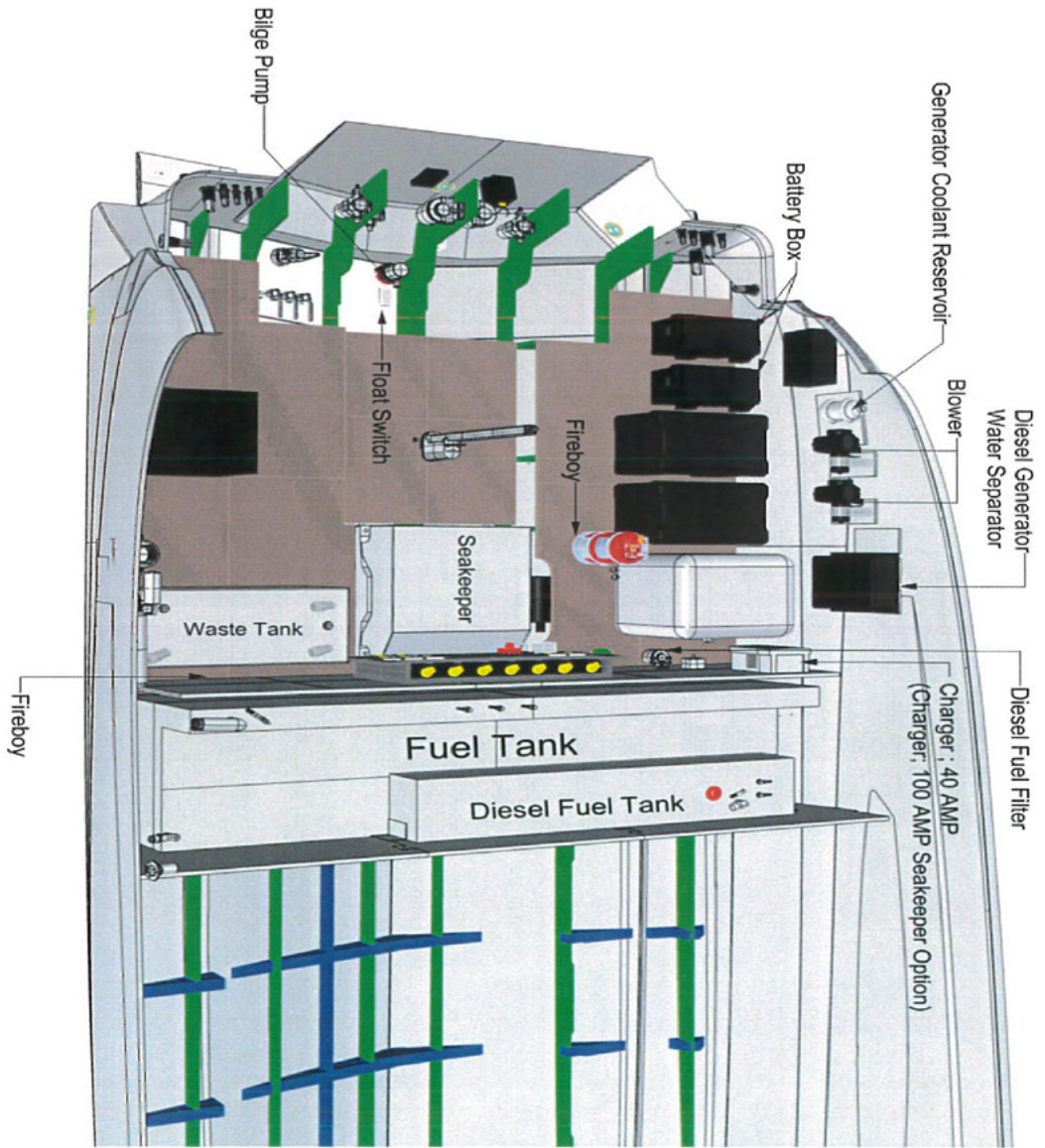

REGAL MARINE INDUSTRIES  
 2000 W. 10th Street  
 Ocala, FL 32067  
 TEL: (352) 369-8888  
 FAX: (352) 369-8889  
 WWW.REGALMARINE.COM

DRAWING TITLE		REGAL MARINE INDUSTRIES	
36 XO (VK) Sump Layout		2000 W. 10th Street Ocala, FL 32067 TEL: (352) 369-8888 FAX: (352) 369-8889 WWW.REGALMARINE.COM	
DATE	REVISED	SCALE	
12/05/2019	-	2 OF 5	
DRAWN BY	APPROVED BY	DATE	
DMC	-	MVK23B	

# SUMP (BILGE) LAYOUT 3

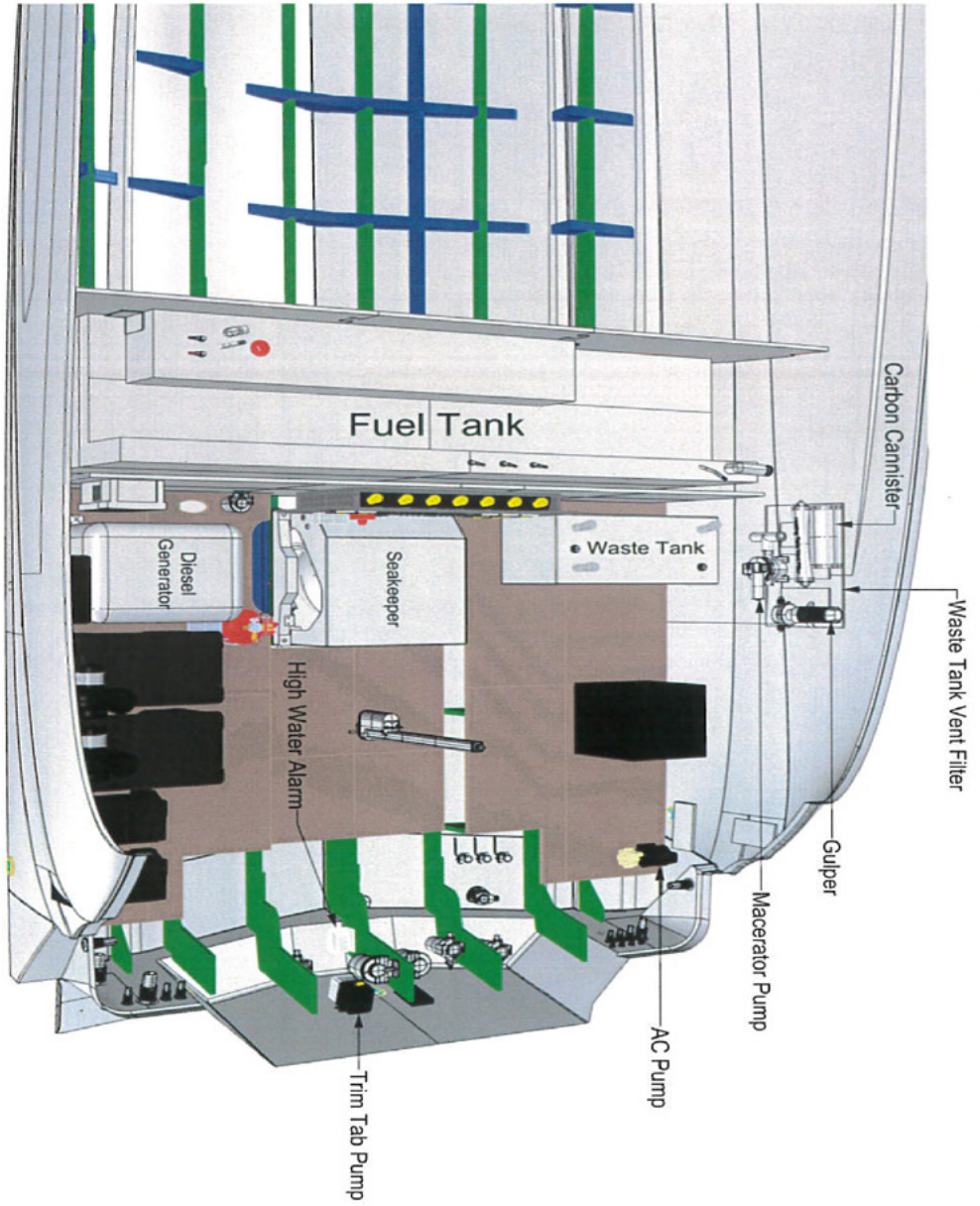

REGAL MARINE INDUSTRIES  
 2000 W. US HWY 1, SUITE 100  
 TAMPA, FL 33606  
 TEL: 813-889-8800

DRAWING TITLE		REGAL MARINE INDUSTRIES 2000 W. US HWY 1, SUITE 100 TAMPA, FL 33606 TEL: 813-889-8800	
36 XO (YK) Sump Layout		ALL RIGHTS RESERVED	
DATE	REVISION	DATE	REVISION
12/05/2019		3 OF 5	
DRAWN BY	APPROVED BY	DATE TO	
DMC		MM/YY	

# SUMP (BILGE) LAYOUT 4

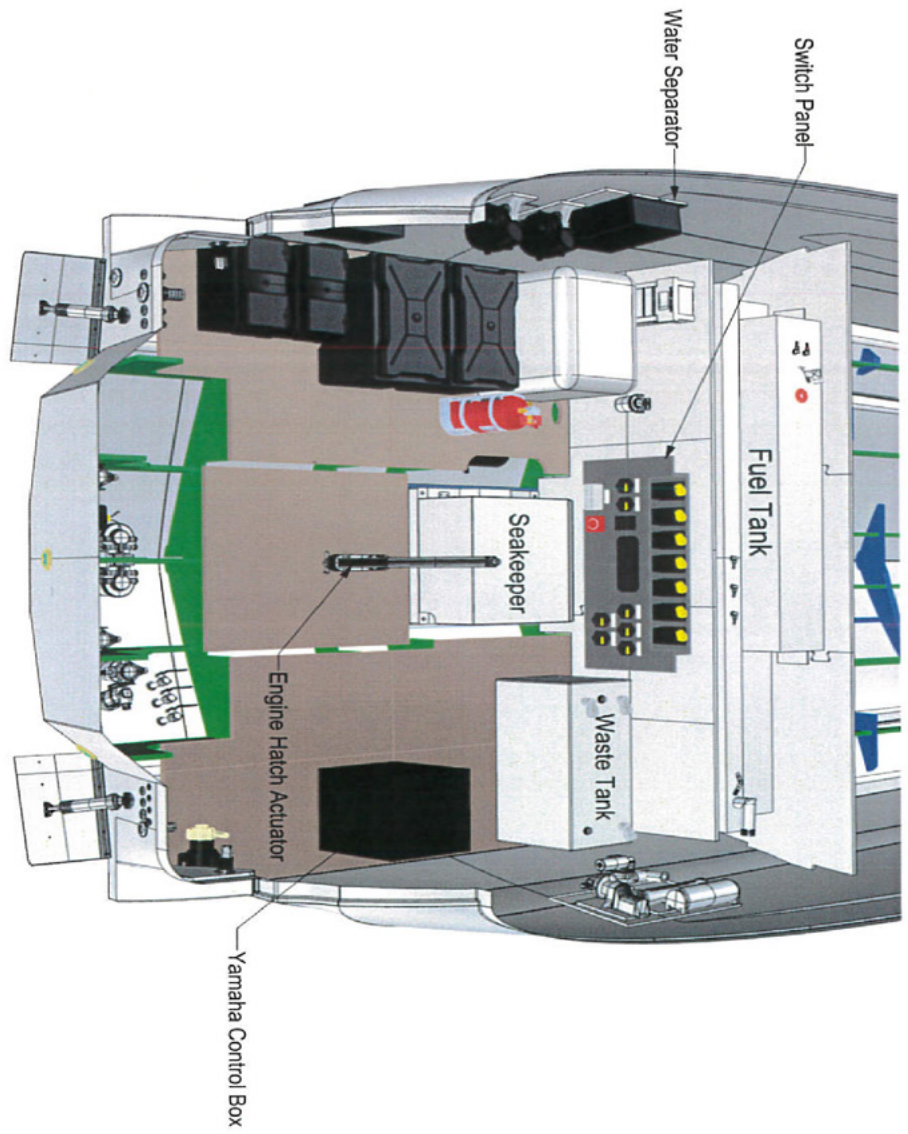

THESE DRAWINGS AND COMPONENTS THEREOF ARE THE PROPERTY OF REGAL MARINE INDUSTRIES. ANY REPRODUCTION WITHOUT THE WRITTEN PERMISSION OF REGAL MARINE INDUSTRIES IS PROHIBITED.

<p>REGAL MARINE INDUSTRIES                  2700 SHIPLEY DRIVE                  OAKLAND, CALIFORNIA 94621                  TEL: (415) 331-1000</p>			
<p>ALL RIGHTS RESERVED</p>			
<p>DRAWING TITLE  <b>36 XO (MK) Sump Layout</b></p>			
DATE	REVISED	PAGE	
12/09/2019	-	4 OF 5	
DRAWN BY	APPROVED BY	DATE	
DMC	-	MM/23B	



# SUMP (BILGE) LAYOUT 5

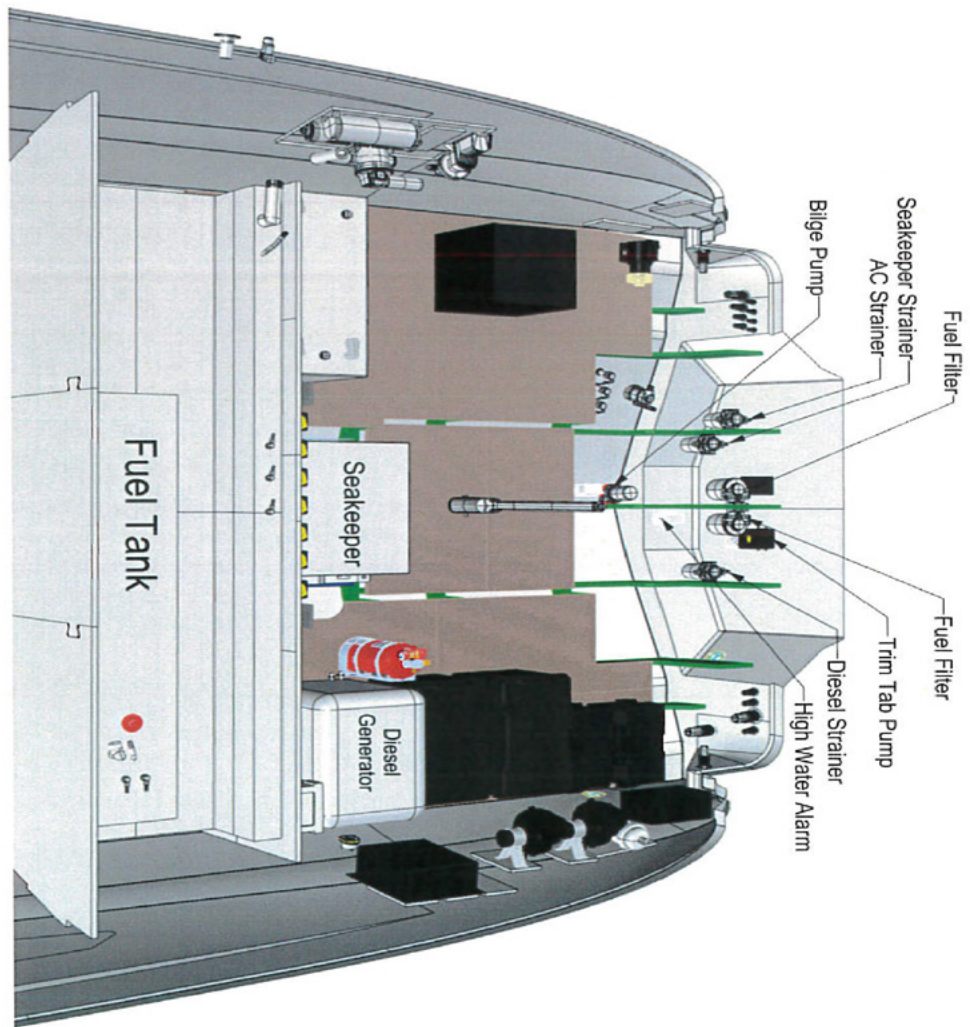

REGAL MARINE INDUSTRIES AND COMPANIES, INC. MAKES NO WARRANTY, REPRESENTATION OR AGREEMENT OF REGAL MARINE INDUSTRIES AND COMPANIES, INC. FOR ANY DAMAGE TO THE VESSEL OR PERSONS OR PROPERTY OF ANY KIND THAT MAY BE CAUSED BY THE OPERATION OF THE VESSEL WITHOUT THE WRITTEN PERMISSION OF REGAL MARINE INDUSTRIES, INC.

DRAWING TITLE			
36 XO (WK) Sump Layout			
REGAL MARINE INDUSTRIES 28000 150th Street, Suite 100 Lynnwood, WA 98037 TEL: (206) 881-4466 FAX: (206) 881-4467			
DATE: 12/05/2019			
DESIGNED BY: DMC	DRAWN BY: -	CHECKED BY: -	DATE: 5 OF 5
DWG. NO.: M/VK23B			



# HULL HARDWARE 1

STBD Side

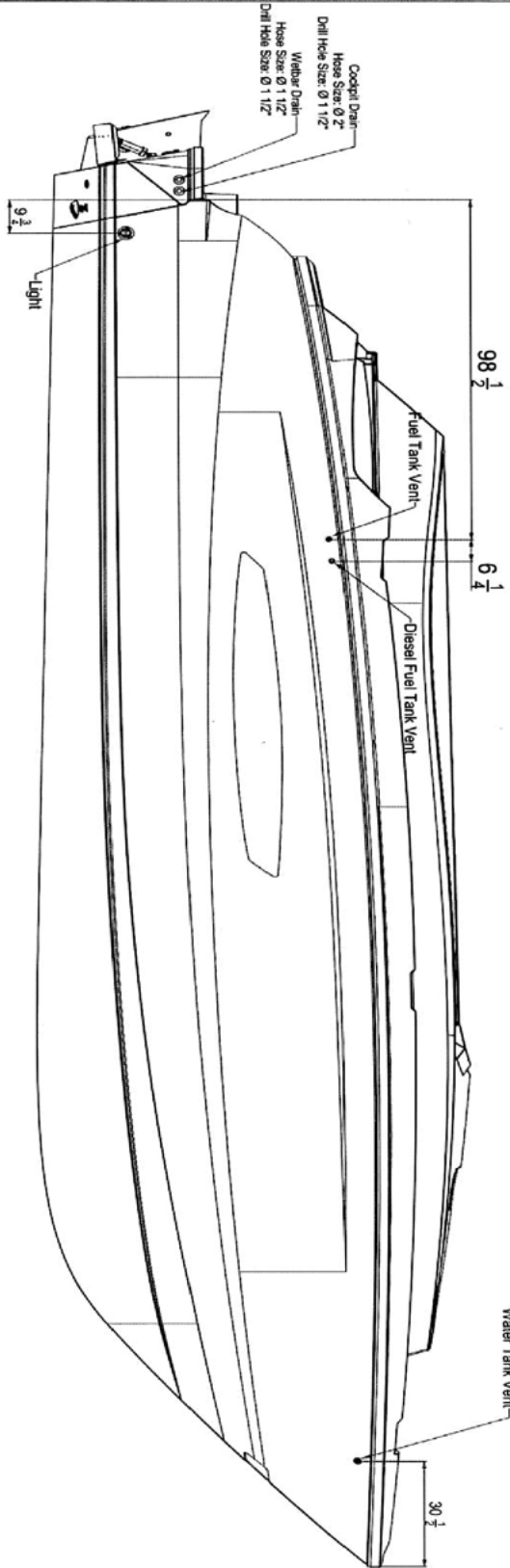

REGAL MARINE INDUSTRIES  
2300 ZEPHYRUS DRIVE  
ORLANDO, FLORIDA 32838  
TEL: 407/241-1100  
WWW.REGALMARINE.COM

REGAL MARINE INDUSTRIES 2300 ZEPHYRUS DRIVE ORLANDO, FLORIDA 32838 TEL: 407/241-1100 WWW.REGALMARINE.COM			ALL RIGHTS RESERVED
DRAWING TITLE: <b>36 XO Hull Hardware</b>			
DATE: <b>2/20/2020</b>	REVISION: -	PAGE: <b>1 OF 4</b>	
DRAWN BY: <b>DMC</b>	APPROVED BY: -	SHIP CODE: <b>MYK24B</b>	

# HULL HARDWARE 2

Port Side



REGAL MARINE INDUSTRIES  
 2000 W. 10th Street  
 St. Louis, MO 63103  
 TEL: 314-991-1000

REGAL MARINE INDUSTRIES		ALL RIGHTS RESERVED	
36 XO Hull Hardware			
DATE	REVISION	SIZE	
2/20/2020		2 OF 4	
DESIGNER	APPROVER	DATE	
DMC		MV/K24B	

# HULL HARDWARE 3

## Transom View

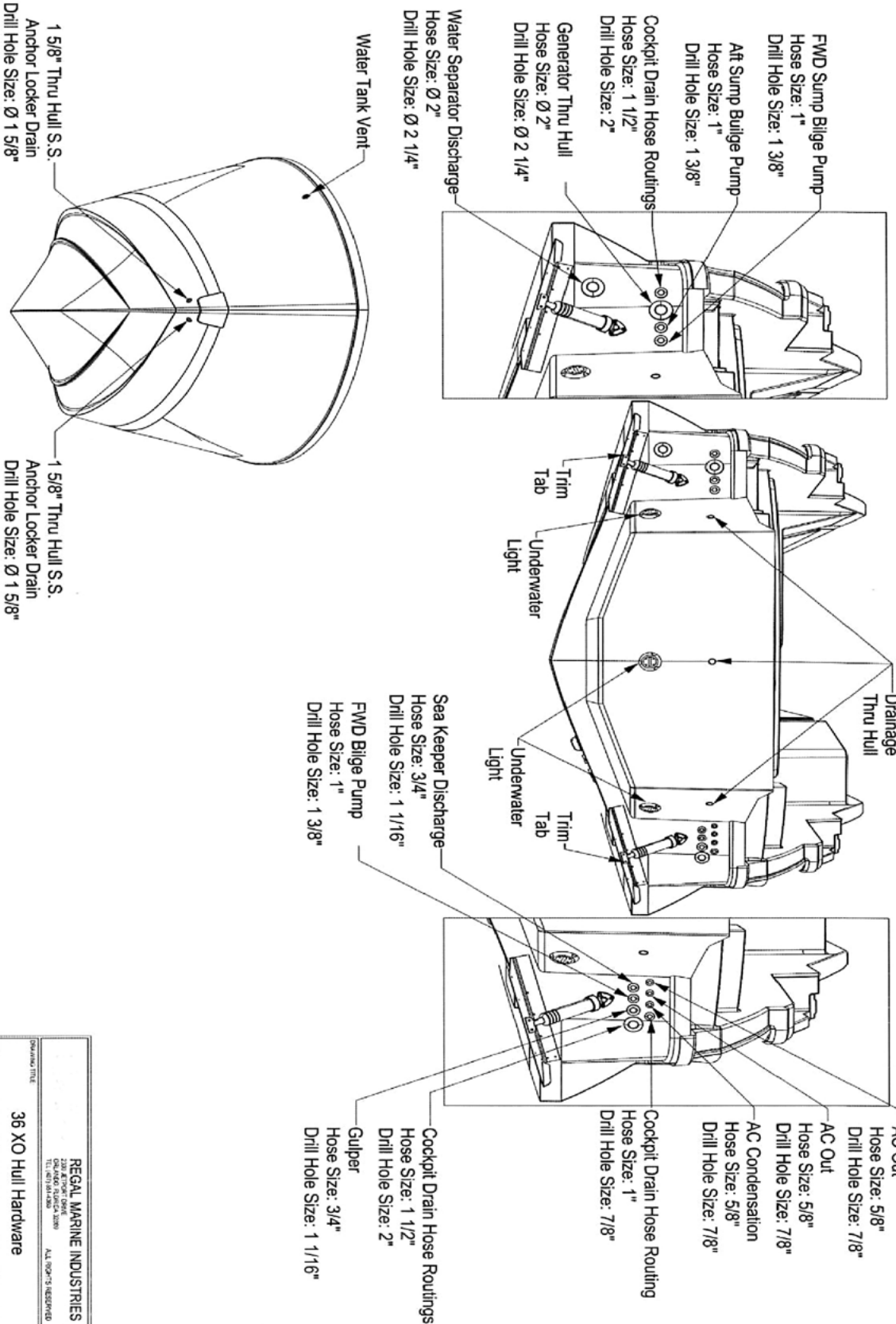

<p>REGAL MARINE INDUSTRIES                  2700 WILSON AVENUE                  ONTARIO, CALIFORNIA 91764                  TEL: (909) 949-8888 FAX: (909) 949-8889                  ALL RIGHTS RESERVED</p>			
<p>DRAWING TITLE: <b>36 XO Hull Hardware</b></p>			
DATE: <b>2/20/2020</b>	REVISED:	APPROVED BY:	SCALE: <b>3 OF 4</b>
DRAWN BY: <b>DMC</b>			DWG NO: <b>MW/K24B</b>

REGAL MARINE INDUSTRIES AND COMPASSIONATE INDUSTRIES ARE REPRODUCING IN PART OR IN FULL THE SOLE PROPERTY OF REGAL MARINE INDUSTRIES. ANY REPRODUCTION IN PART OR IN FULL WITHOUT THE WRITTEN PERMISSION OF REGAL MARINE INDUSTRIES IS PROHIBITED.

# HULL HARDWARE 4

## Sump View

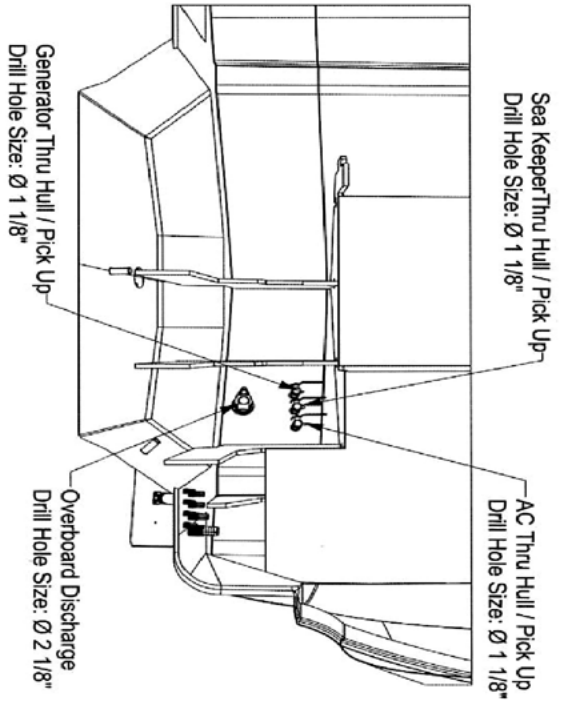

## Hull Bottom

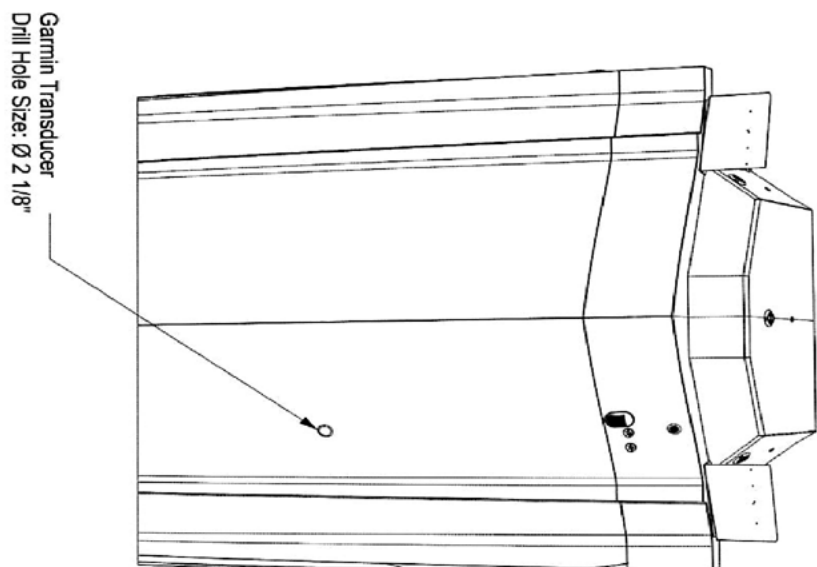

REGAL MARINE INDUSTRIES  
200 A PROJECT DRIVE  
MILWAUKEE, WI 53212  
TEL: (414) 751-4200  
ALL RIGHTS RESERVED

DATE: 2/20/2020  
DRAWN BY: DMC  
REVISION: -  
APPROVED BY: -  
PAGE: 4 OF 4  
CAGE NO: MVK24B

36 XO Hull Hardware



PROPRIETARY AND CONFIDENTIAL  
THIS INFORMATION CONTAINED IN THIS DRAWING IS THE SOLE PROPERTY OF REGAL MARINE INDUSTRIES. IT IS TO BE USED FOR THE PROJECT AND VESSEL SPECIFICALLY IDENTIFIED HEREIN. PERMISSION OF REGAL MARINE INDUSTRIES IS REQUIRED TO REPRODUCE OR TRANSMIT IN ANY FORM OR BY ANY MEANS, ELECTRONIC OR MECHANICAL, INCLUDING PHOTOCOPYING, RECORDING, OR BY ANY INFORMATION STORAGE AND RETRIEVAL SYSTEM.

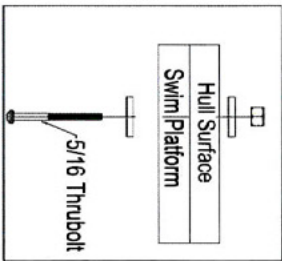
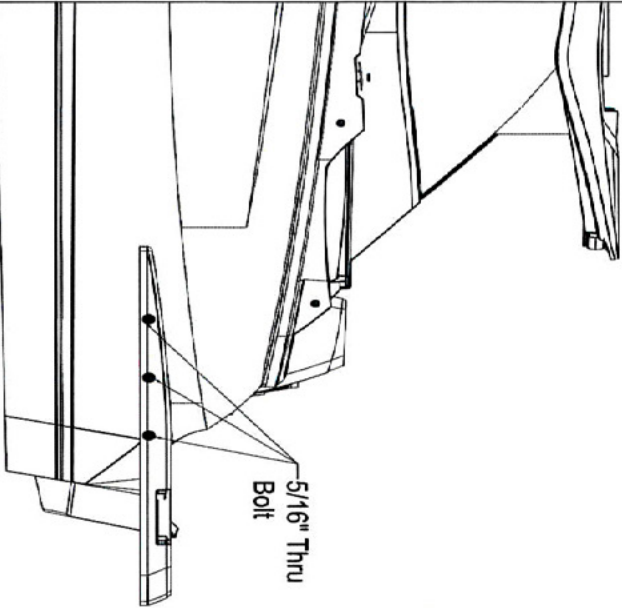
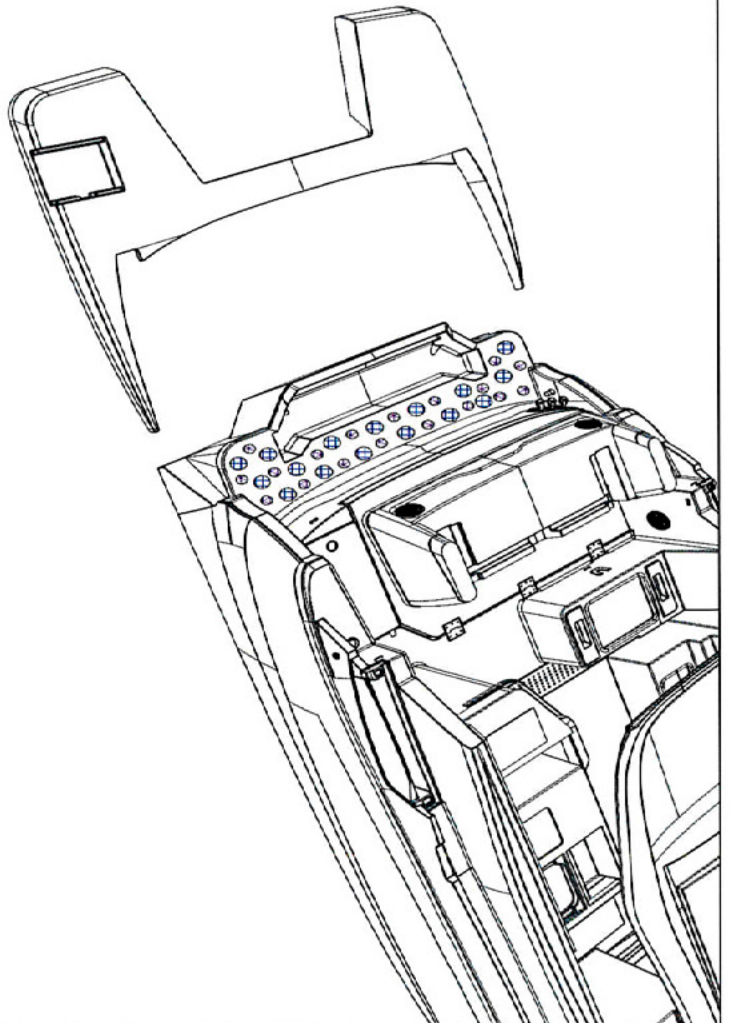
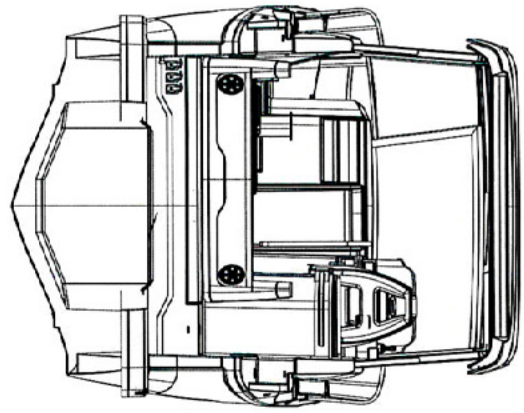

# SWIM PLATFORM



IMPORTANT: READ AND UNDERSTAND THE INSTRUCTIONS CONTAINED IN THIS DRAWING. THE SOLE RESPONSIBILITY OF REGAL MARINE INDUSTRIES FOR THE PROPER INSTALLATION OF THIS SWIM PLATFORM IS THE USER'S RESPONSIBILITY. REGAL MARINE INDUSTRIES IS NOT RESPONSIBLE FOR ANY DAMAGE TO THE HULL OR SWIM PLATFORM.

-  Acralock
-  920 Adhesive

<b>REGAL MARINE INDUSTRIES</b>			
2006 ALBERT DRIVE P.O. BOX 48099 TALLAHASSEE, FL 32314-0809			
ALL RIGHTS RESERVED			
<b>36 SC (VK) Swim Platform Installation</b>			
DATE	REVISION	PAGE	
05/11/2020	-	1 OF 1	
DRAWN BY	APPROVED BY	DMC	MMK24E

# 36 OUTBOARD UPHOLSTERY IDENTIFIER

Bundle	Assembly	Description
1	UVK01A	AFT CABIN STBD CUSHION
2	UVK01B	AFT CABIN STBD CUSHION FRAME
3	UVK01C	AFT CABIN FILLER CUSHION
4	UVK01D	AFT CABIN PORT CUSHION
5	UVK01E	AFT CABIN PORT BACKREST
6	UVK01F	AFT CABIN A/C PANEL
7	UVK01G	AFT CABIN STBD FWD CLOSEOUT
8	UVK01H	AFT CABIN WALL PANELS
9	UVK01J	AFT CABIN VALANCE
10	UVK01K	AFT CABIN STBD WINDOW MUFF
11	UVK01L	AFT CABIN PORT WINDOW MUFF
12	UVK01M	AFT CABIN TV PANEL
13	UVK01N	
14	UVK01P	
15	UVK02A	MID CABIN CUSHION
16	UVK02B	MID CABIN BACKREST
17	UVK02C	ATRIUM LIGHT PANEL
18	UVK02D	V-BERTH BUNK KEEPER
19	UVK02E	V-BERTH PORT SHELF
20	UVK02F	V-BERTH STBD SHELF
21	UVK02G	V-BERTH HEADBOARD
22	UVK02H	V-BERTH LIGHTING PANELS
23	UVK02J	V-BERTH BULKHEAD
24	UVK02K	V-BERTH BUNK
25	UVK02L	V-BERTH PORT HULL SIDE VINYL
26	UVK02M	V-BERTH STBD HULL SIDE VINYL
27	UVK02N	V-BERTH STBD FWD CABINET
28	UVK02P	V-BERTH TV WALL
29	UVK02Q	MID CABIN HEAD VINYL
30	UVK04A	HEAD WALL PANELS
31	UVK04B	SHOWER DOOR TRACK
32	UVK04C	HEAD LIGHTING PANEL
33	UVK04D	HEAD WALL PANELS
34		
35		
36		
37		
38		
39		

*\*Note that the identifier can be used to assist in ordering upholstery needs throughout the life of the vessel*



# 36 OUTBOARD UPHOLSTERY IDENTIFIER

VK 36XO UPH UPHOLSTERY IDENTIFIER				
Bundle	Assembly	Description	Sub	Vinyl
40	UVK06A	BOW FWD CUSHION		
41	UVK06B	BOW PORT CUHION		
42	UVK06C	BOW STBD CUSHION		
43	UVK06D	BOW STBD CUP HOLDER PANEL		
44	UVK06E	BOW AFT CUSHION		
45	UVK06F	BOW PORT CUP HOLDER PANEL		
46	UVK06G	BOW AFT BACKREST		
47	UVK06H			
48	UVK06J			
49	UVK14A	ATRIUM FWD PANEL		
50	UVK14B	ATRUIM PORT PANEL		
51	UVK14C	COMPANION G.O.V.		
52	UVK14D	ENTRY DOOR MUFF		
53	UVK13A	HELM STORAGE		
54	UVK13B	DASH		
55	UVK13C	SHIFTER		
56	UVK13D	HELM SEAT		
57	UVK13E	DASH VISOR		
58	UVK15A	SALON FWD CUSHION (STD)		
59	UVK15B	SALON FWD BACKREST (STD)		
60	UVK15C	SALON FWD FLIP FLOP BACKREST (STD)		
61	UVK15D	SALON FWD FLIP FLOP BACKREST (OPT)		
62	UVK15E	SALON FWD BASE PANEL (STD)		
63	UVK15F	SALON AFT BACKREST (W/O)		
64	UVK15G	SALON AFT CUSHION (W/O)		
65	UVK15H	SALON AFT BACKREST (W/SD)		
66	UVK15J	SALON AFT CUSHION (W/SD)		
67	UVK15K	SALON ARMREST (W/SD)		
68	UVK15L	PATIO BACKREST (W/SD)		
69	UVK15M	PATIO ARMREST (W/SD)		
70	UVK15N	PATIO CUSHION (W/SD)		
71	UVK15P	PATIO BACKREST (W/SD)		
72	UVK15Q	PATIO OB CUSHION (W/O)		
73	UVK15R	PATIO CENTER CUSHION (W/O)		
74	UVK15S	PATIO IB CUSHION (W/O)		
75	UVK15T	PATIO FLIP FLOP BACKREST (W/O)		
76	UVK15U	SALON T.V.		
77	UVK15V	PATIO HARDTOP PANELS		
78	UVK15W	SALON HARDTOP PANELS		
79				
80	UVK17A	ENGINE HATCH PORT CUSHION		
81	UVK17B	ENGINE HATCH CENTER CUSHION		
82	UVK17C	ENGINE HATCH STBD CUSHION		
83	UVK17D	ENGINE HATCH BACKREST		
84	UVK17E	ENGINE HATCH FWD PANEL		
85	UVK15Z	SALON STBD COLUMN MUFF (W/SD)		
86	UVK15Y	SALON PORT COLUMN MUFF (W/SD)		
87	UVK15YA	SALON STBD COLUMN MUFF (W/O)		
88	UVK15ZA	SALON PORT COLUMN MUFF (W/O)		
89				
90				

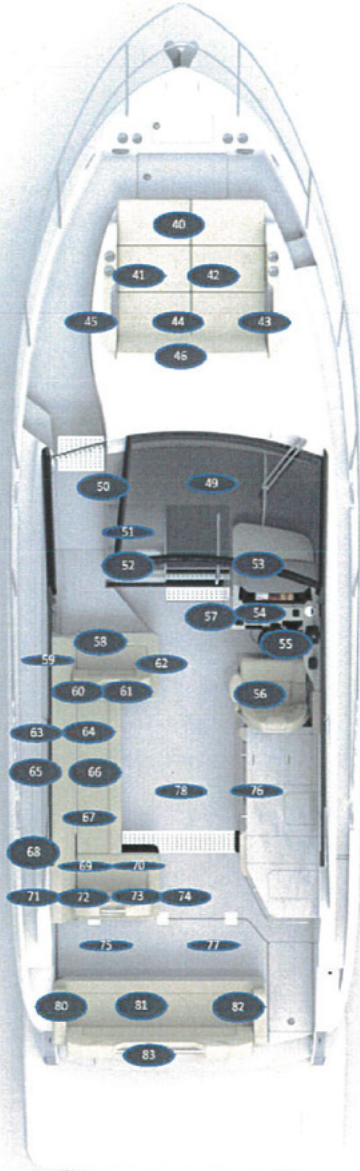

*\*Note that the identifier can be used to assist in ordering upholstery needs throughout the life of the vessel*

## **36 GRAND COUPE ONLY DRAWINGS (VESSEL HIN=VJ)**

*NOTE AS PART OF REGAL'S COMMITMENT TO PRODUCT IMPROVEMENT SPECIFICATIONS, COMPONENTS, AND LOCATIONS DISPLAYED IN DRAWINGS AND/OR DOCUMENTATION MAY CHANGE AT ANY TIME. SELECT COMPONENTS ARE OPTIONAL AND MAY NOT BE INSTALLED ON YOUR VESSEL.*

*NOTE TO READ SPECIFIC TITLE BOXES FOR DRAWING MODEL TYPE AND DESCRIPTION. MODEL SPECIFIC INFORMATION ON INDIVIDUAL DRAWINGS IS NOTED BY AN \* SYSTEM.*

*NOTE THAT INITIAL DRAWINGS WERE TITLED SC. THE VESSEL NAME IS NOW DESIGNATED AS THE GRAND COUPE.*



# GRAND COUPE MAIN DIMENSIONS

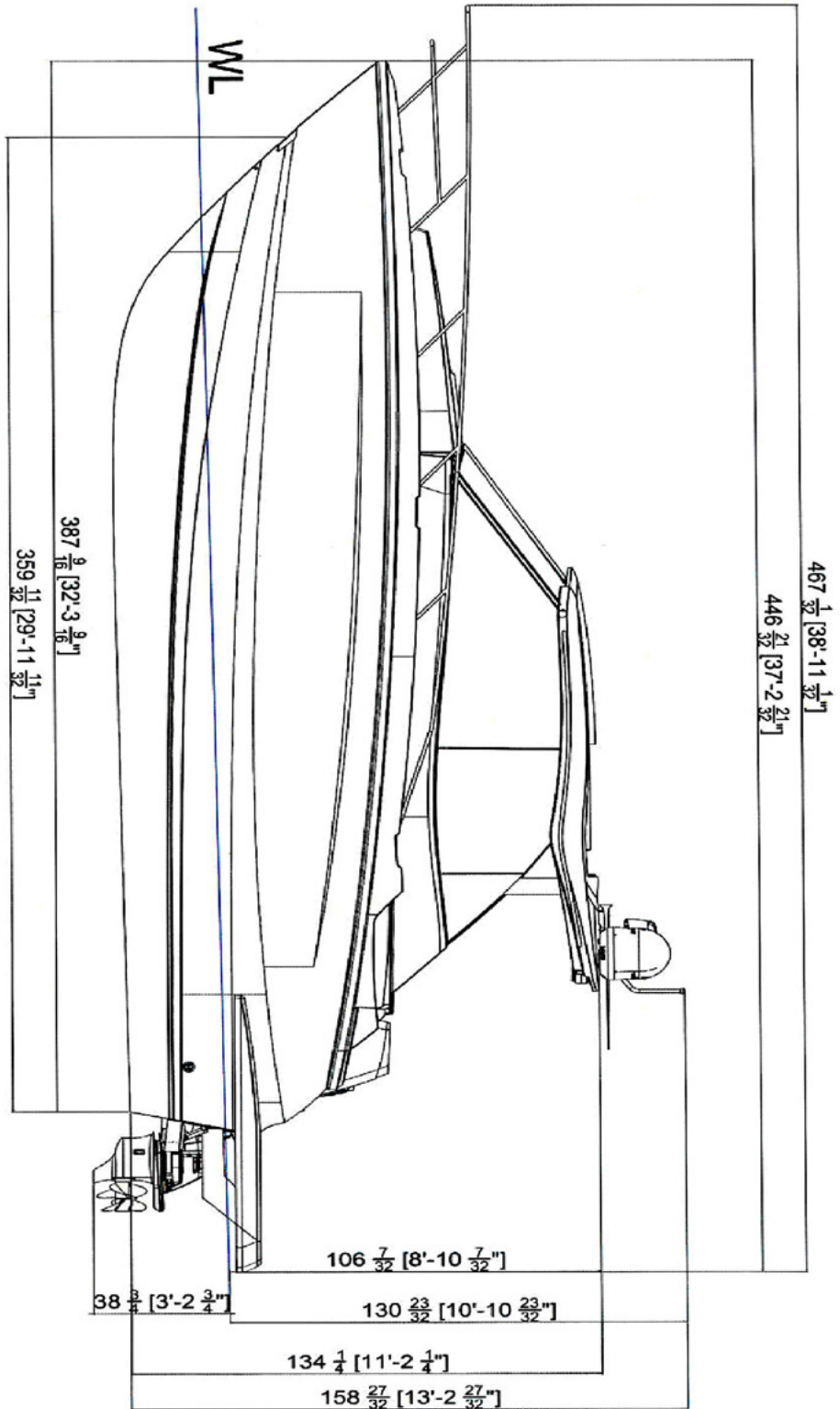

**REFERENCE ONLY**

FOR PARTIAL AND COMPLETE INFORMATION REGARDING THE SOLE IMPORTER OF REGAL BOATS IN THE UNITED STATES AND SELECTION OF PARTS OR ACCESSORIES, PLEASE CONTACT THE IMPORTER OR REGAL MARINE INDUSTRIES DIRECTLY.

REGAL MARINE INDUSTRIES 2022 EIGHTH STREET ORLANDO, FLORIDA 32803 TEL: 407-518-2800		ALL RIGHTS RESERVED	
DATE	7/16/2020	REVISION	
BY	DMC	APPROVED BY	
36 GC (VJ) Main Dimensions		PLATE	1 OF 1

# GRAND COUPE MAIN DIMENSIONS 2

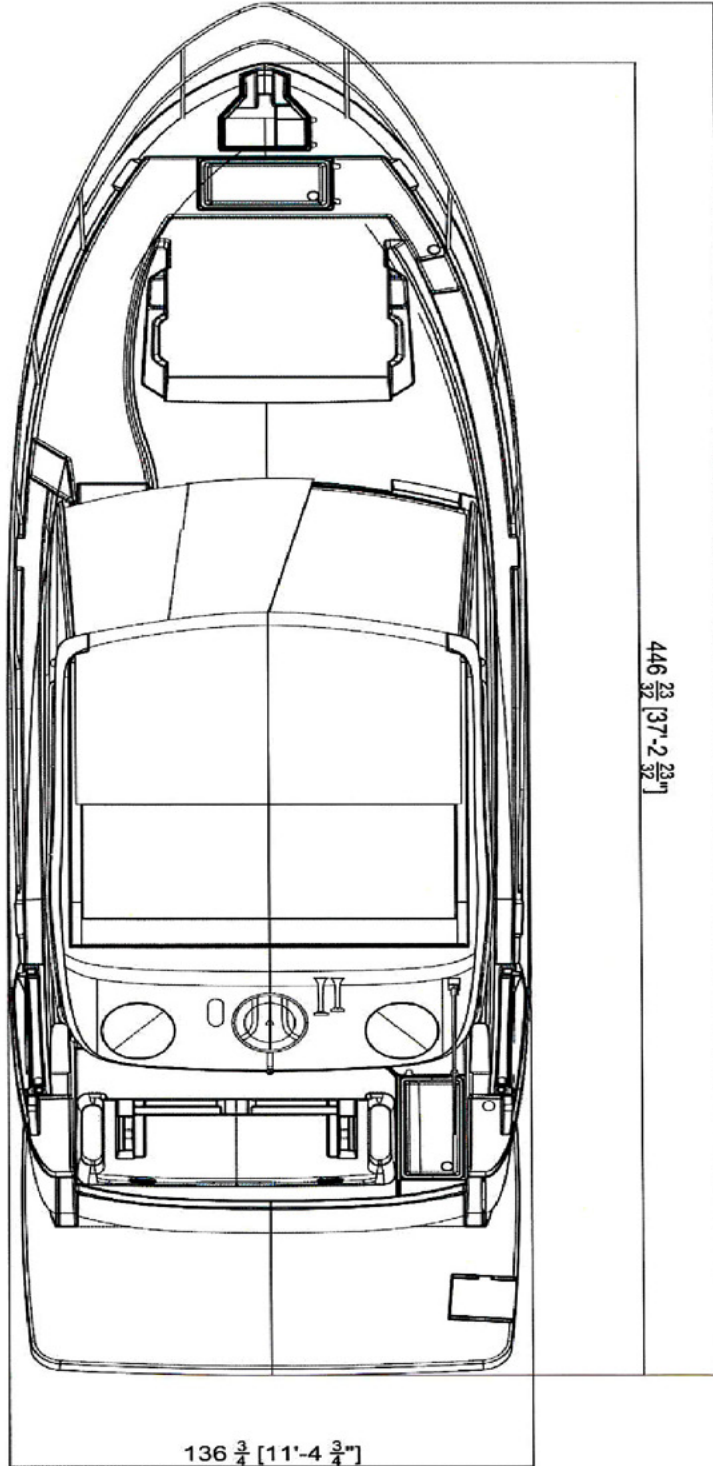

**REFERENCE ONLY**

REGAL MARINE INDUSTRIES AND COMPANIES, INC. IS NOT RESPONSIBLE FOR THE ACCURACY OF THE INFORMATION CONTAINED IN THIS DOCUMENT. THE INFORMATION IS PROVIDED FOR REFERENCE ONLY AND DOES NOT CONSTITUTE A WARRANTY OR A GUARANTEE OF ANY KIND. THE INFORMATION IS PROVIDED AS IS AND WITHOUT WARRANTY OF ANY KIND. THE INFORMATION IS PROVIDED AS IS AND WITHOUT WARRANTY OF ANY KIND.

<b>REGAL MARINE INDUSTRIES</b> 2000 W. 10th Street Chicago, IL 60608-1000 TEL: 708.486.1000		ALL RIGHTS RESERVED	
DRAWING TITLE: <b>36 GC (VJ) Main Dimensions</b>			
DATE:	7/16/2020	VERSION:	1 OF 1
DRAWN BY:	DMC	APPROVED BY:	

# GRAND COUPE DOMESTIC SEATING POSITIONS

15.5" W X 29.5" L  
Allowance Per Person



Domestic Seating Positions: 13 Persons

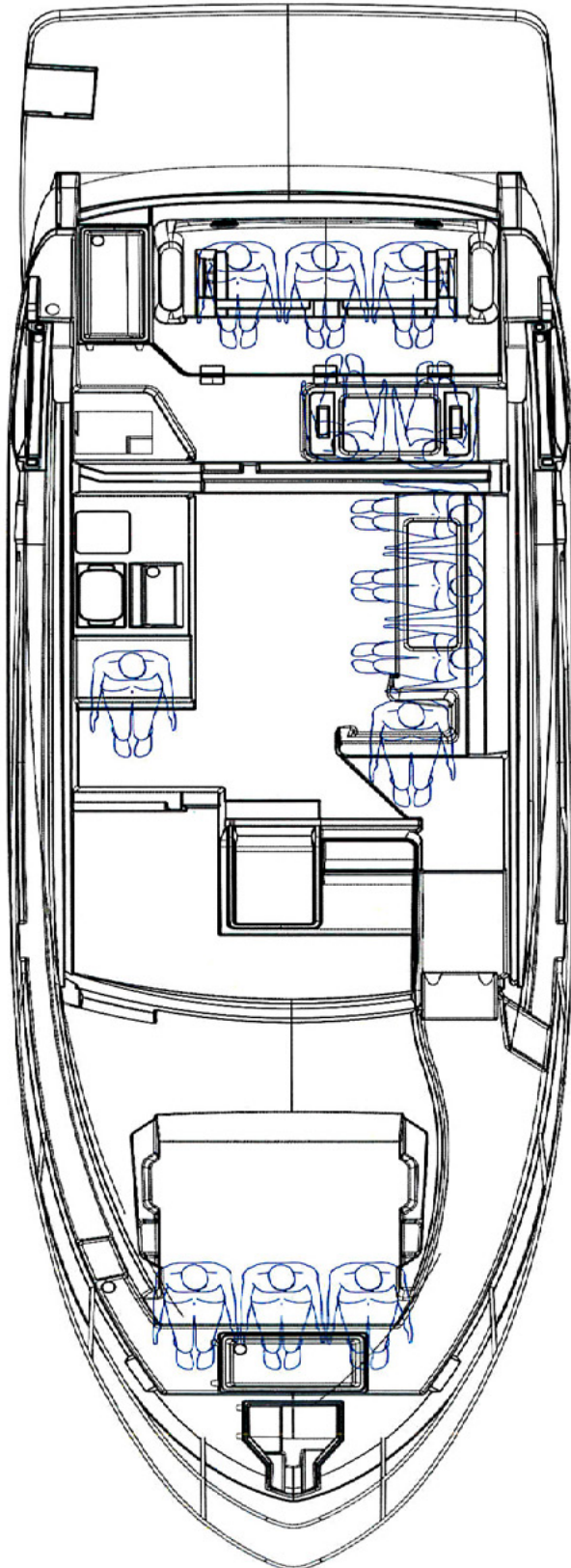

NOTE THAT THE FORWARD SEAT IS NOT TO BE OCCUPIED WHILE MAKING HEADWAY.

**REFERENCE ONLY**

THE INFORMATION CONTAINED IN THIS DOCUMENT IS THE SOLE PROPERTY OF REGAL MARINE INDUSTRIES. NO PART OF THIS DOCUMENT IS TO BE REPRODUCED OR TRANSMITTED IN ANY FORM OR BY ANY MEANS, ELECTRONIC OR MECHANICAL, INCLUDING PHOTOCOPYING, RECORDING, OR BY ANY INFORMATION STORAGE AND RETRIEVAL SYSTEM, WITHOUT THE WRITTEN PERMISSION OF REGAL MARINE INDUSTRIES.

REGAL MARINE INDUSTRIES  
200 ATLANTIC DRIVE  
MOUNTAIN VIEW, NJ 07048  
TEL: 908-251-4300 ALL RIGHTS RESERVED

36 Sport Domestic Seating Capacity

DATE	REVISION	SIZE
6/24/2020	-	1 OF 1
DATE IN <td>DATE OUT <td>DATE IN </td></td>	DATE OUT <td>DATE IN </td>	DATE IN
DMC		2



# BATTERY DESCRIPTION- TYPICAL 36 GRAND COUPE

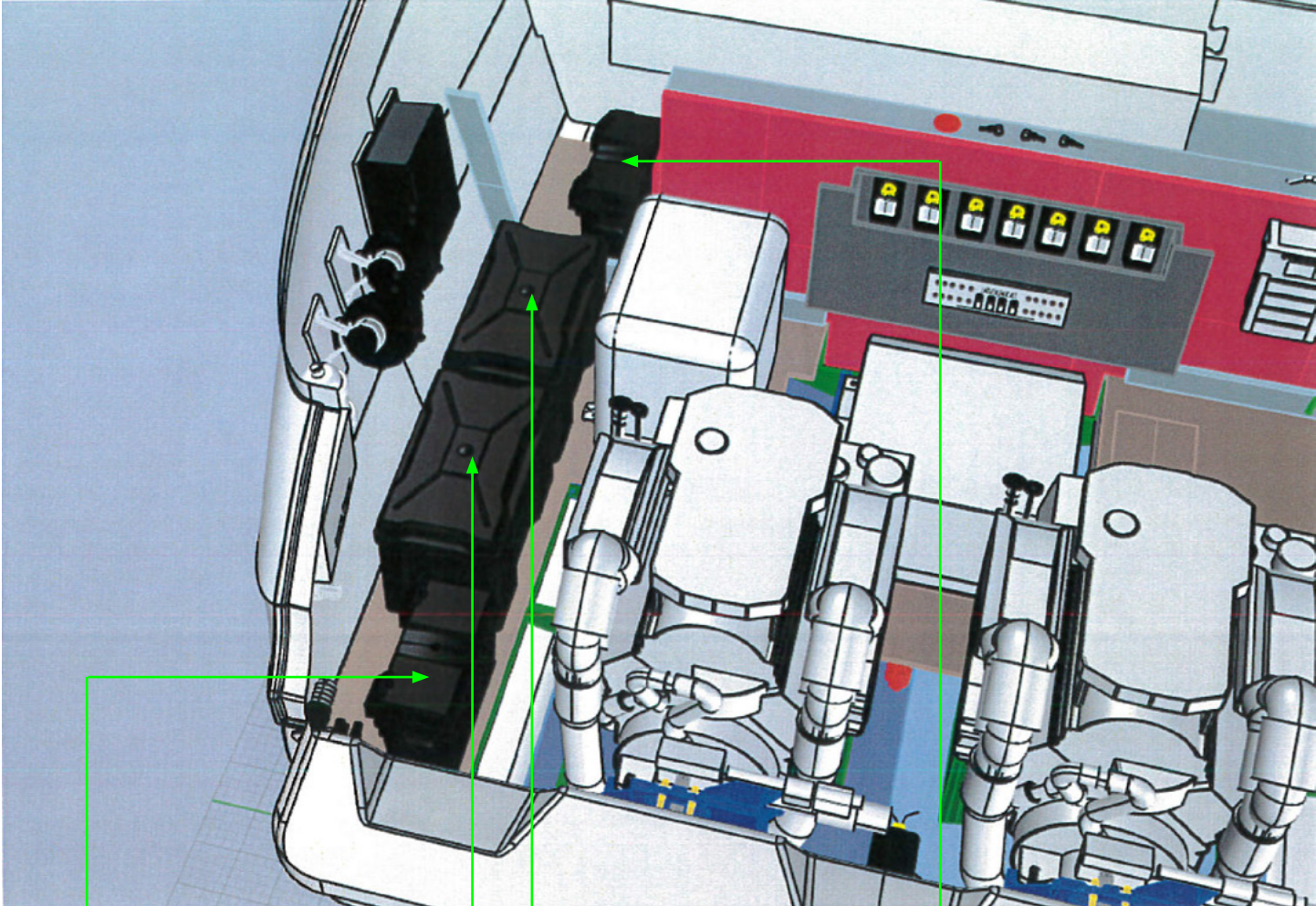

PORT ENGINE BATTERY

HOUSE MAIN BATTERY

HOUSE ACCESSORY BATTERY

STARBOARD ENGINE BATTERY



# VOLVO EVC/GLASS COCKPIT FUEL/WATER LEVEL WIRING

Subject Work Instruction: Volvo EVC/Glass Cockpit Fuel/Water Level	Issue Date: 04/24/2020	Rev: 0	Document No. EL-118
Approved By: Dion Colbourne	Written By: Kyle Quatman	Rev Date: ----	Page: 1 of 1

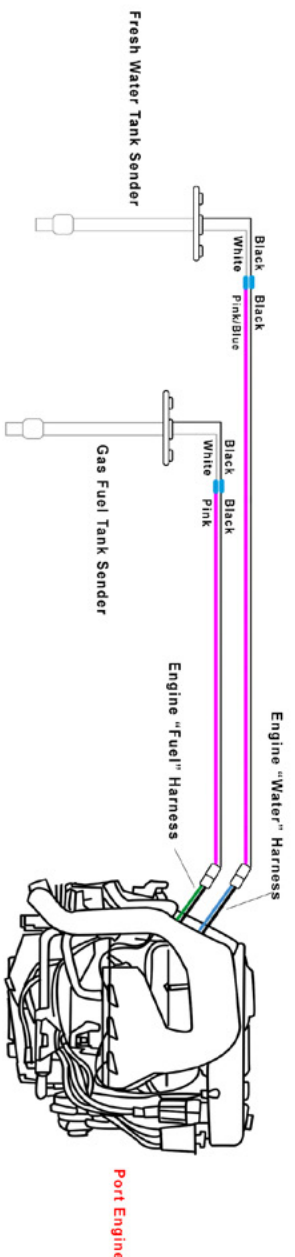
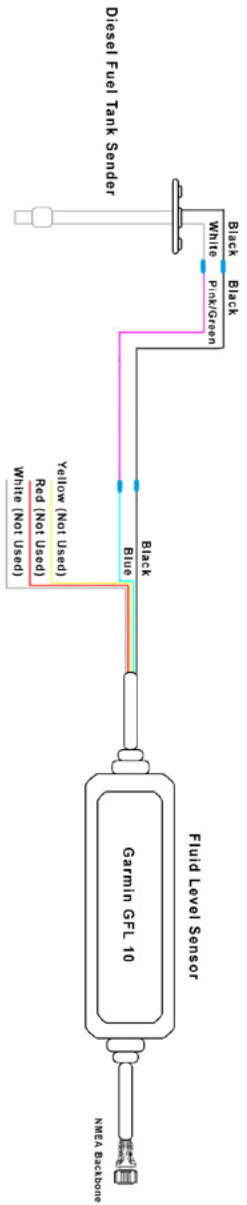

# VOLVO GLASS COCKPIT SYSTEM-OVERVIEW

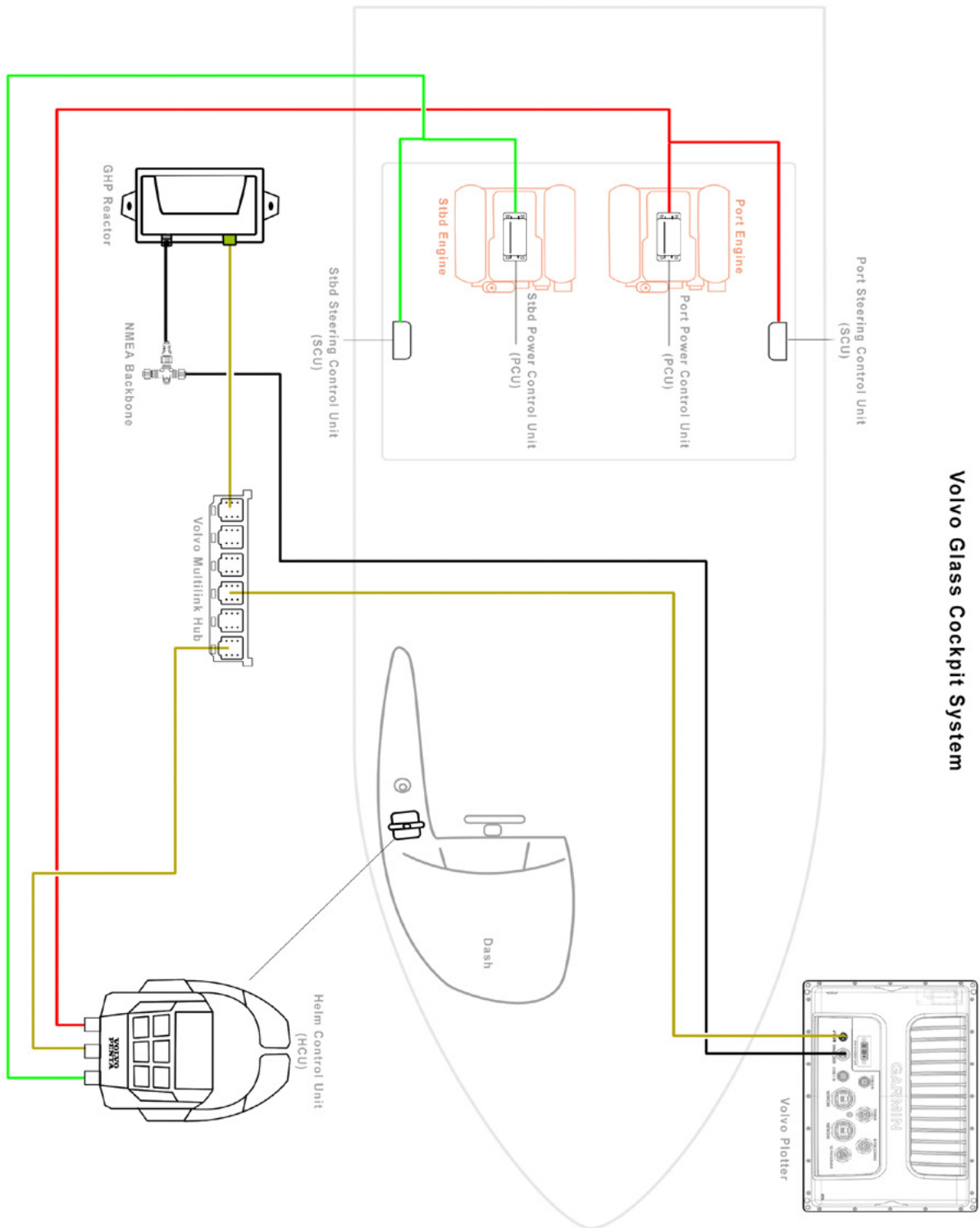

# VOLVO GLASS COCKPIT NMEA NETWORK

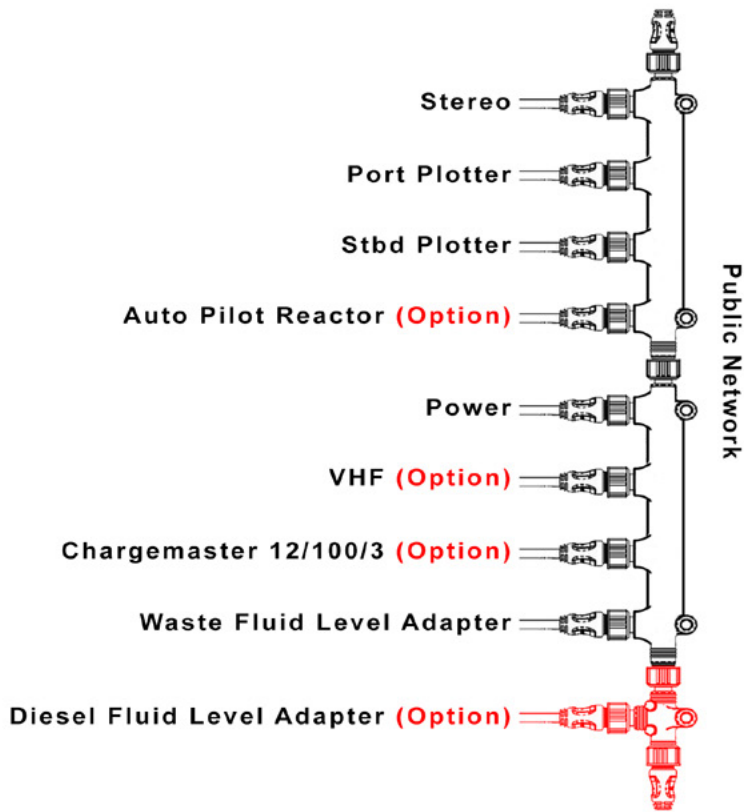

Subject Work Instruction: VJ Volvo Glass Cockpit NMEA Network	Issue Date: 06/02/2020	Rev: 1	Document No. EL-113
Approved By: Dion Colbourne	Written By: Kyle Quatman	Rev Date: ----	Page: 1 of 1

**[ REFERENCE ONLY ]**

# FUEL TANK HOSE ROUTING 1

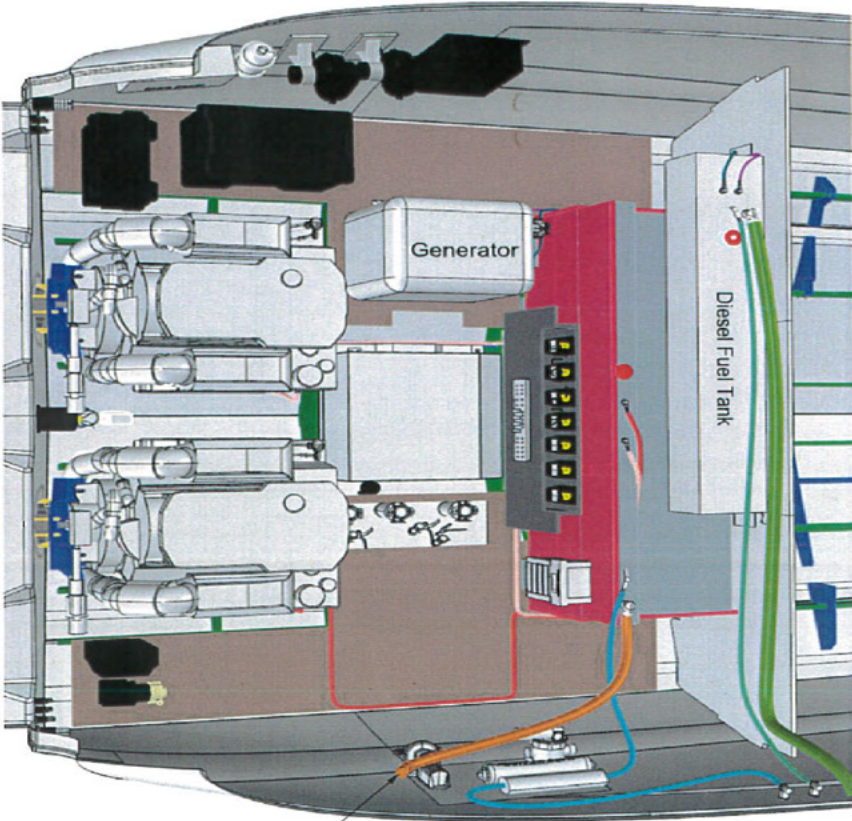

Route to Fill Cap on Deck

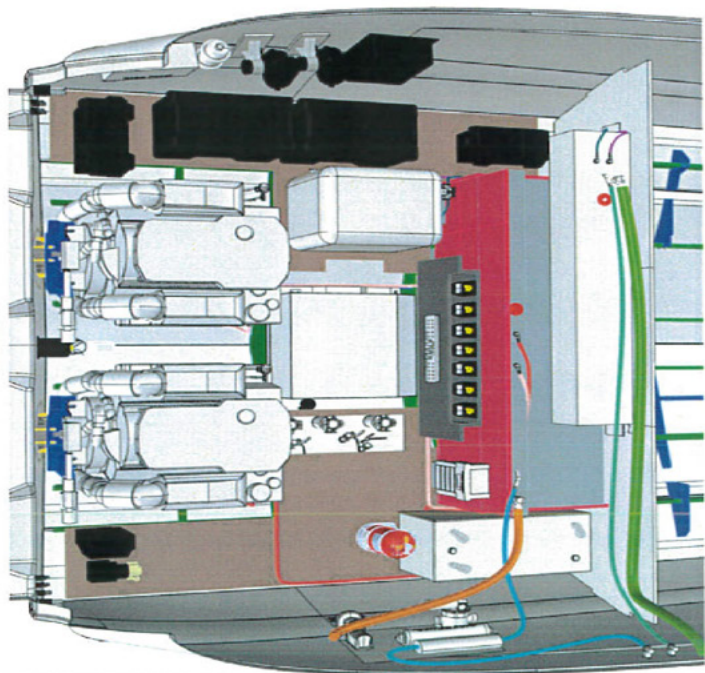

Normal View

Route To Fill Cap on Deck

- Fuel Vent Routing 5/8" Ø  
Hose Length: 100 in
- Fuel Fill Routing 1 1/2" Ø  
Hose Length: 80 in
- Port Engine Fuel Routing 3/8" Ø  
Hose Length: 138 in
- STBD Engine Fuel Routing 3/8" Ø  
Hose Length: 166 in
- Generator Fuel Routing 5/16" Ø  
Hose Length: 96 in
- Generator Fuel Return 5/16" Ø  
Hose Length: 100 in

## REFERENCE ONLY

INSPECTION AND CORRECTION OF THIS DRAWING IS THE SOLE RESPONSIBILITY OF THE WORKER. THE INSTALLER MUST BE A LICENSED MARINE MECHANIC AND MUST BE A MEMBER OF THE MARINE MECHANICS ASSOCIATION OF AMERICA (MMA) OR THE NATIONAL ASSOCIATION OF MARINE MECHANICS (NAMI).

 <b>REGAL MARINE INDUSTRIES</b> 10000 W. CENTRAL EXPRESSWAY THE WOODBRIDGE		ALL RIGHTS RESERVED	
DATE	4/14/2020	ISSUE NO.	1 OF 4
DESIGN BY	DMC	APPROVED BY	DMC
REV. NO.		REV. NO.	MVJ23C

36 SC (V) Fuel Tank Installation and Routings



# FUEL TANK HOSE ROUTING 2

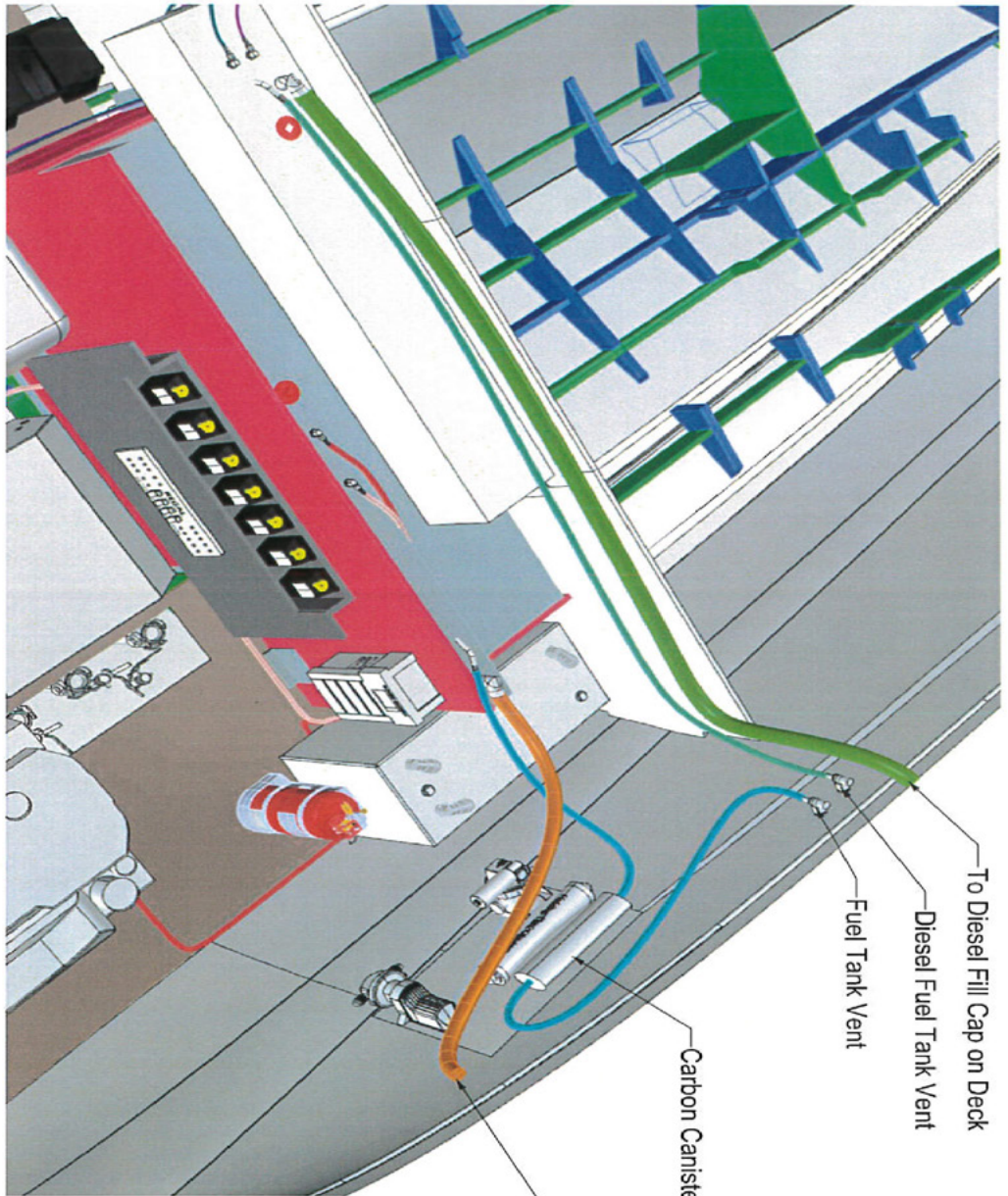

To Diesel Fill Cap on Deck

Diesel Fuel Tank Vent

Fuel Tank Vent

Carbon Canister

To Fuel Fill Cap on Deck

- Fuel Vent Routing 5/8" Ø  
Hose Length: 100 in
- Fuel Fill Routing 1 1/2" Ø  
Hose Length: 60 in
- Port Engine Fuel Routing 3/8" Ø  
Hose Length: 138 in
- STBD Engine Fuel Routing 3/8" Ø  
Hose Length: 166 in
- Generator Fuel Routing 5/16" Ø  
Hose Length: 95 in
- Generator Fuel Return 5/16" Ø  
Hose Length: 100 in

## REFERENCE ONLY

REGAL MARINE INDUSTRIES  
36 SC (VJ) Fuel Tank Installation and Routings

 <b>REGAL MARINE INDUSTRIES</b> 2200 AIRPORT DRIVE WESTLAND, MI 48186-1500 TEL: 734.487.1400 FAX: 734.487.1401			
DATE	REVISION	PAGE	
4/14/2020	-	2 OF 4	
OWNER	APPROVED BY	DWG. NO.	
DMC	-	MW123C	



# FUEL TANK HOSE ROUTING 3

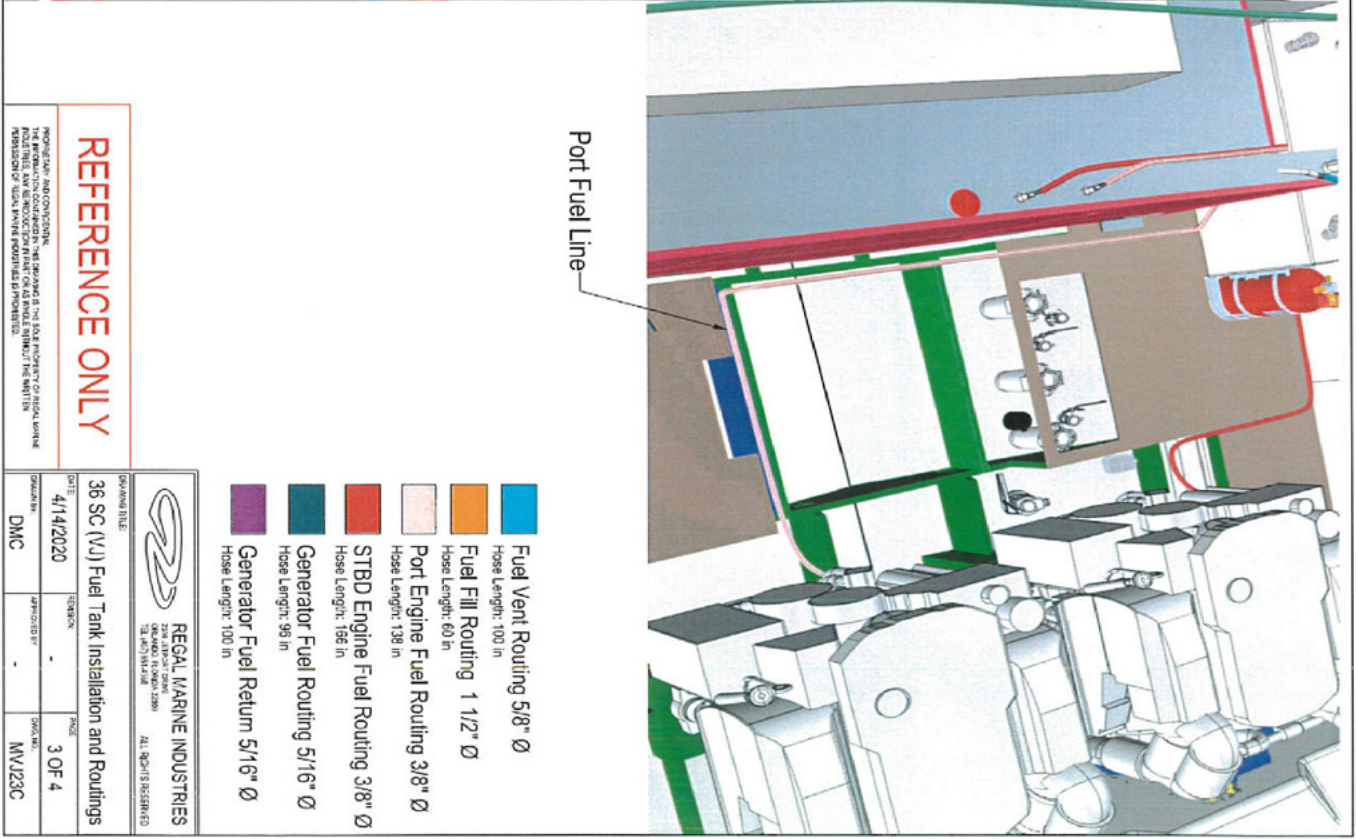
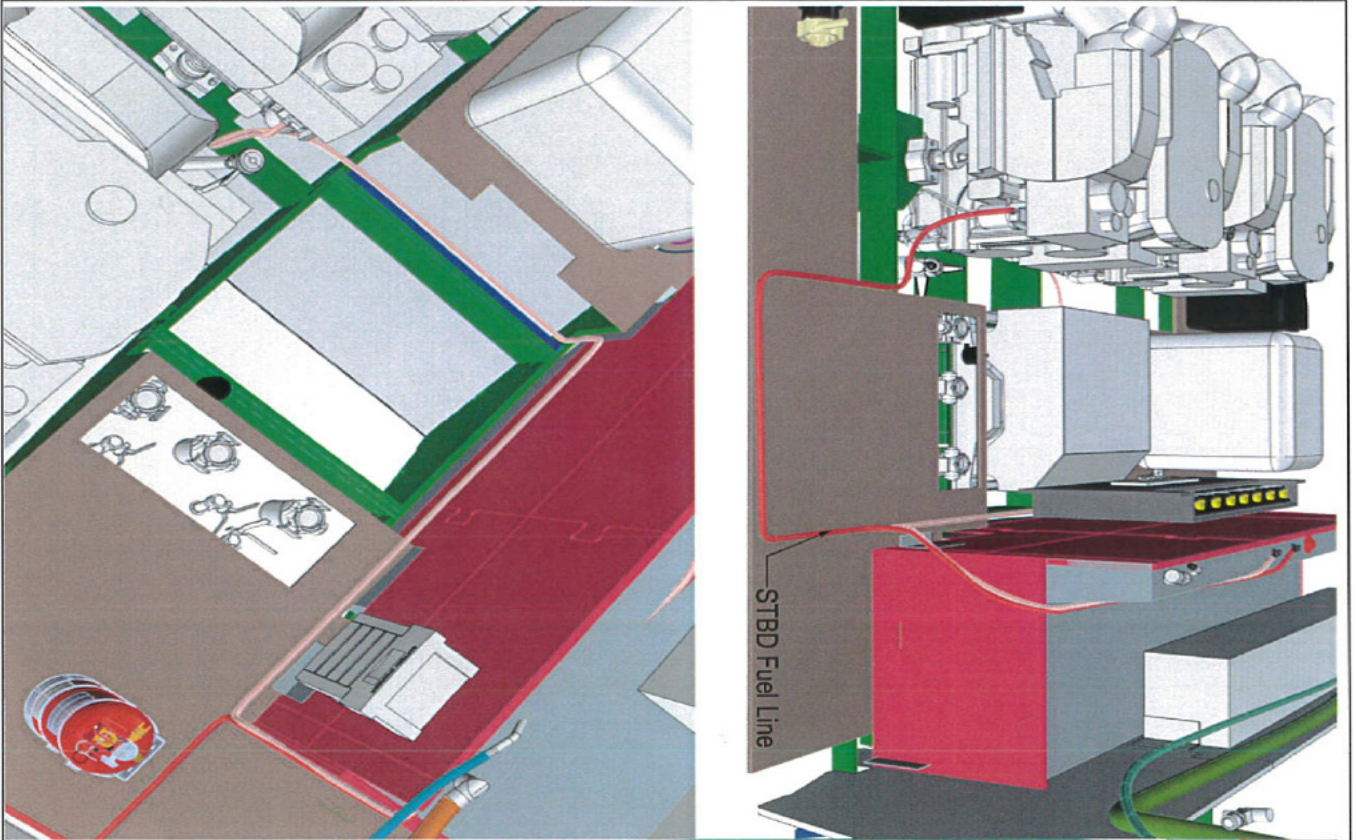

- Fuel Vent Routing 5/8" Ø  
Hose Length: 100 in
- Fuel Fill Routing 1 1/2" Ø  
Hose Length: 60 in
- Port Engine Fuel Routing 3/8" Ø  
Hose Length: 138 in
- STBD Engine Fuel Routing 3/8" Ø  
Hose Length: 156 in
- Generator Fuel Routing 5/16" Ø  
Hose Length: 95 in
- Generator Fuel Return 5/16" Ø  
Hose Length: 100 in

## REFERENCE ONLY

REGAL MARINE INDUSTRIES MAKES NO WARRANTY, REPRESENTATION OR PROMISE OF ANY KIND, EXPRESS OR IMPLIED, IN CONNECTION WITH THE SALE OF ANY PRODUCT. REGAL MARINE INDUSTRIES SHALL NOT BE LIABLE FOR ANY DAMAGE, LOSS OR INJURY TO PERSONS OR PROPERTY, INCLUDING BUT NOT LIMITED TO, ARISING FROM THE USE OF ANY PRODUCT.

**REGAL MARINE INDUSTRIES**  
 20000 15th Avenue, Unit 100  
 Denver, Colorado 80238  
 Tel: 303.751.9128

36 SC (VJ) Fuel Tank Installation and Routings

DATE: 4/14/2020

3 OF 4

DMC

MVJ23C



# FUEL TANK HOSE ROUTING 4

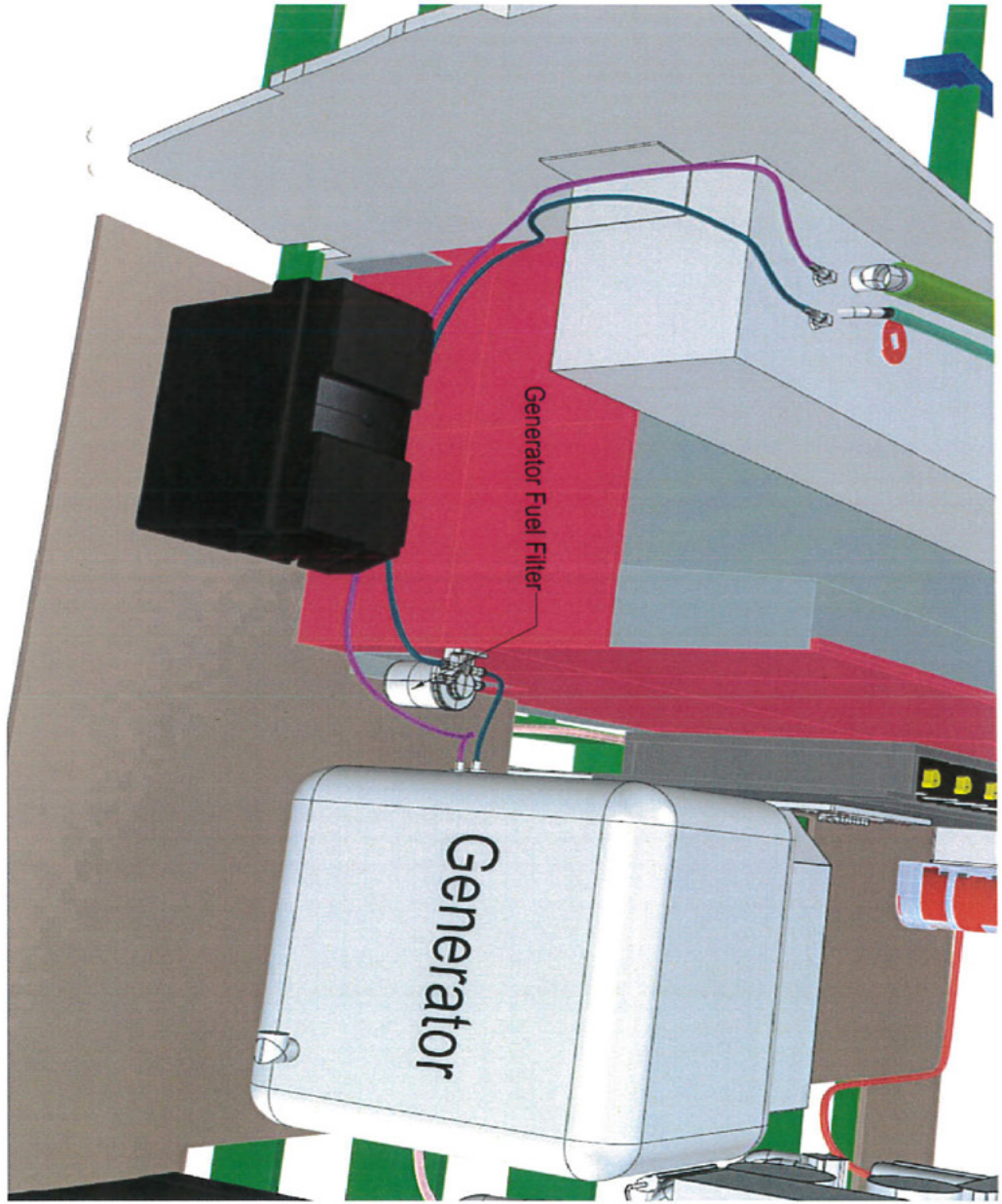

- Fuel Vent Routing 5/8" Ø  
Hose Length: 100 in
- Fuel Fill Routing 1 1/2" Ø  
Hose Length: 60 in
- Port Engine Fuel Routing 3/8" Ø  
Hose Length: 136 in
- STBD Engine Fuel Routing 3/8" Ø  
Hose Length: 166 in
- Generator Fuel Routing 5/16" Ø  
Hose Length: 96 in
- Generator Fuel Return 5/16" Ø  
Hose Length: 100 in

**REGAL MARINE INDUSTRIES**  
 2200 STEWART DRIVE  
 FT. WARD, FLORIDA 32836  
 ALL DIMENSIONS IN INCHES UNLESS SPECIFIED

## REFERENCE ONLY

REGAL MARINE INDUSTRIES  
 THE INFORMATION CONTAINED IN THIS DRAWING IS THE SOLE PROPERTY OF REGAL MARINE  
 INDUSTRIES. ANY REPRODUCTION IN WHOLE OR IN PART, WITHOUT THE WRITTEN  
 PERMISSION OF REGAL MARINE INDUSTRIES IS STRICTLY PROHIBITED.

DATE	REVISION	SIZE
4/14/2020	-	4 OF 4
DWG	REVISED BY	CHK. NO.
		MWJ23C

# WATER TANK HOSE ROUTING OVERVIEW

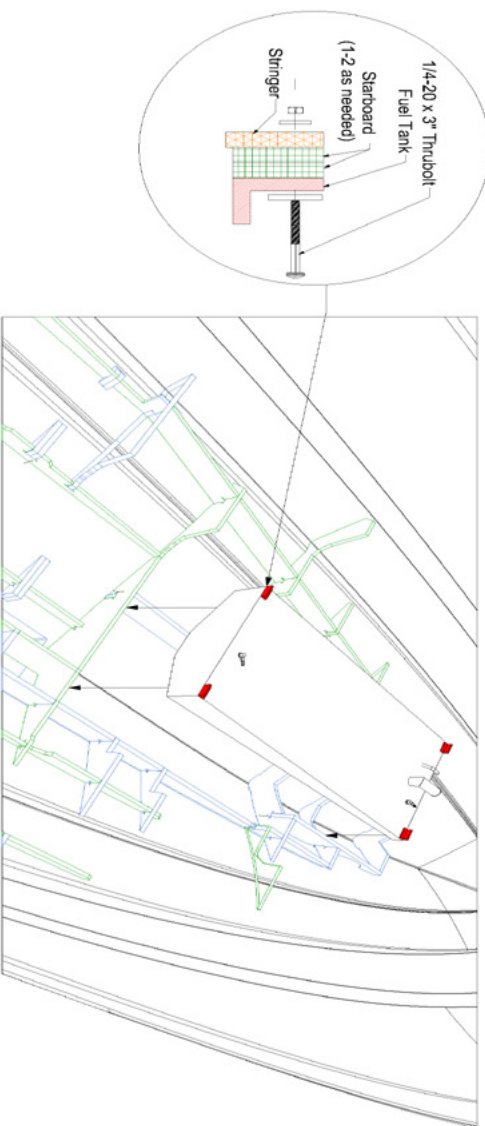
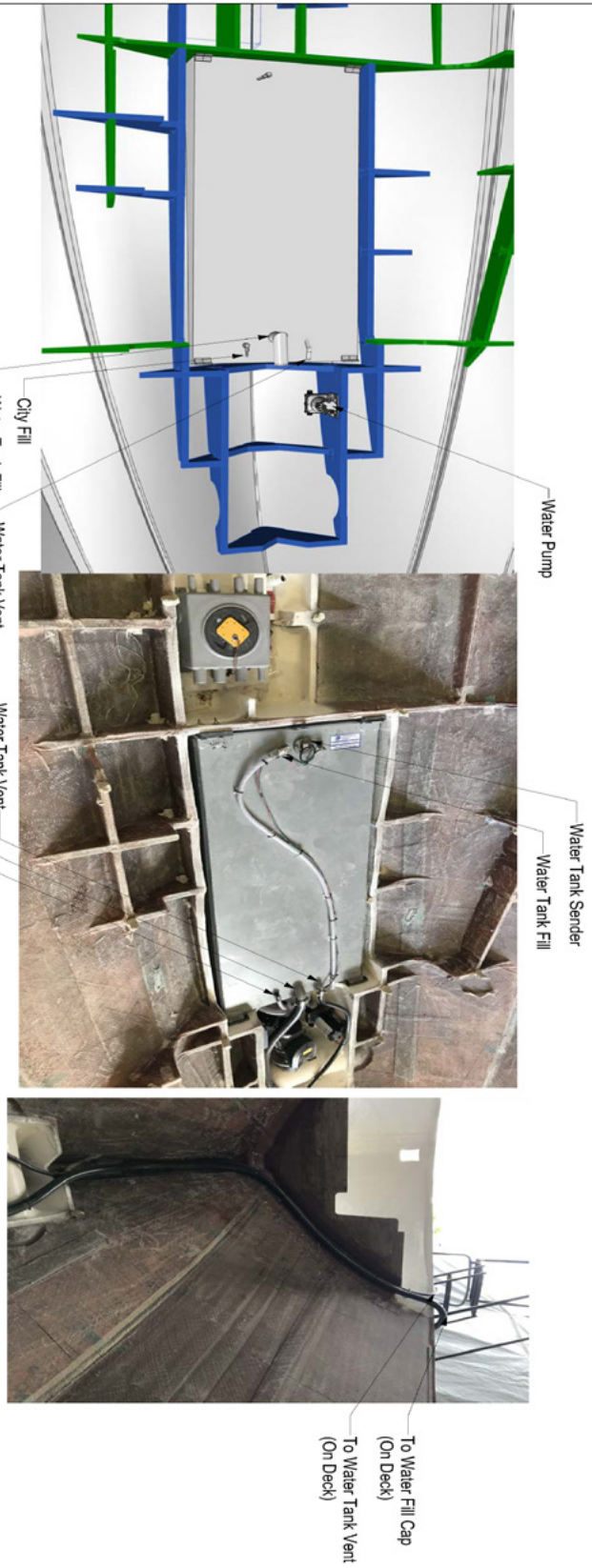

**REFERENCE ONLY**

FOR YOUR INFORMATION AND CONSIDERATION, THE INFORMATION CONTAINED IN THIS DRAWING IS THE SOLE PROPERTY OF REGAL MARINE INDUSTRIES. NO REPRODUCTION OR TRANSMISSION IN ANY FORM OR BY ANY MEANS, WITHOUT THE WRITTEN PERMISSION OF REGAL MARINE INDUSTRIES IS FORBIDDEN.

 <p><b>REGAL MARINE INDUSTRIES</b> 2001 EASTPORT DRIVE ORLANDO, FLORIDA 32839 TEL: 407.371.4400 FAX: 407.371.4401</p>		<p>DATE: 04/16/2020</p> <p>DESIGNER: DMC</p>	
<p>ISSUING TITLE: 36 SC (VJ) Water Tank Routings</p>		<p>REVISION: 1 OF 4</p> <p>APPROVED: MVL/23F</p>	



# WATER TANK HOSE ROUTING HEAD/FLOOR

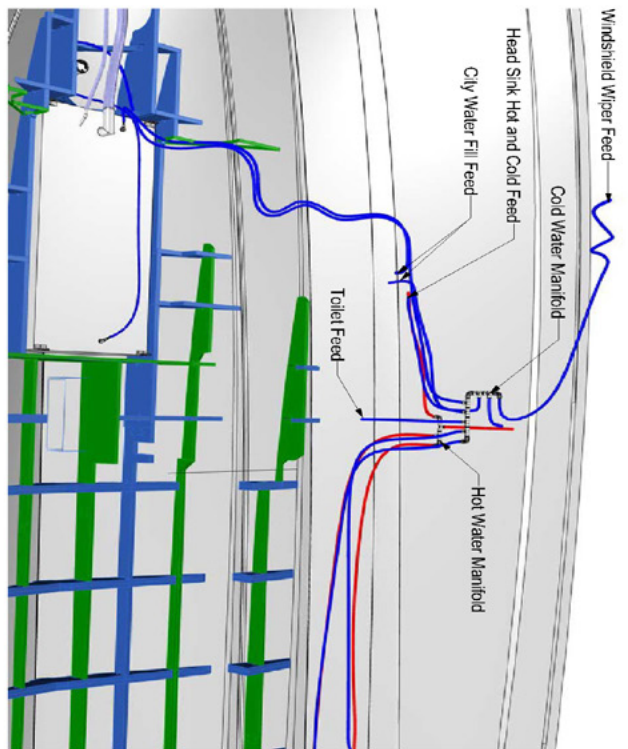
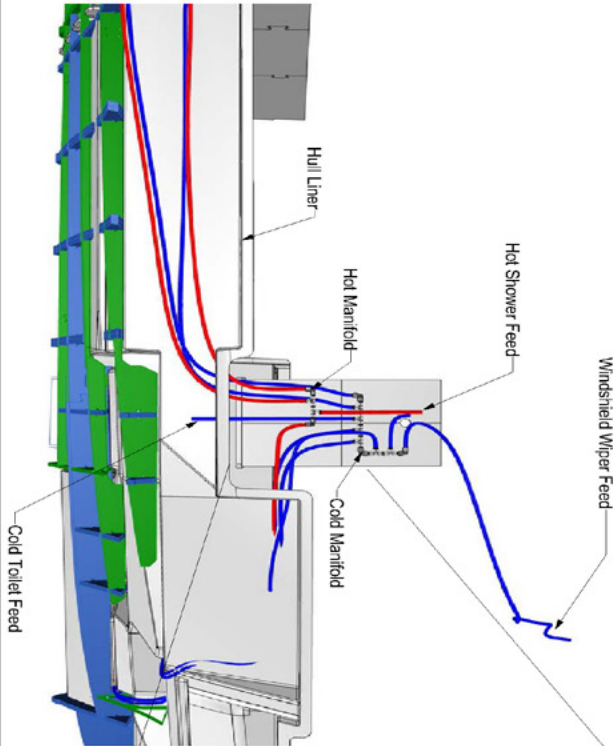
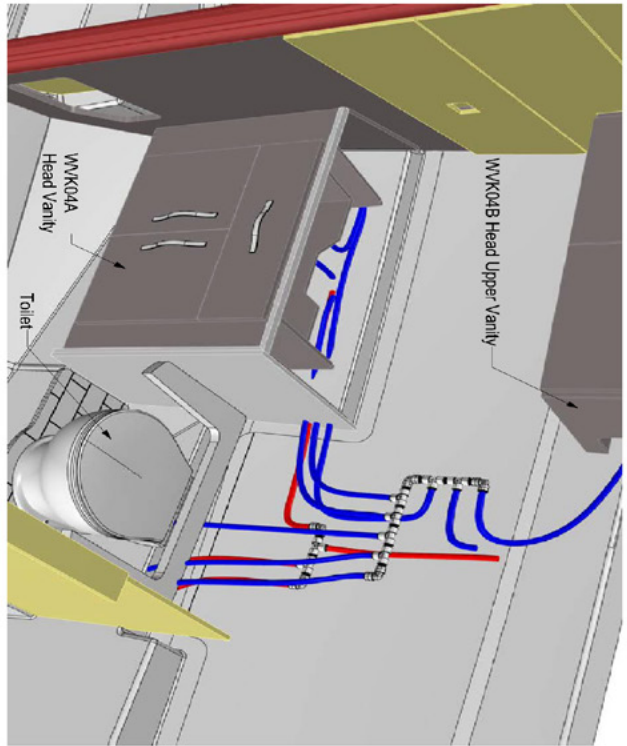

- Windshield Wiper Feed
- Shower Mixer Feed
- Head Sink Feed
- Water Tank Feed
- City Fill Feed
- Toilet Feed
- Wetbar Sink Feed
- Water Heater / Sump Feed
- Hot Shower Feed
- Head Sink Feed
- Hot Wetbar Sink Feed
- Hot Water Heater / Sump Feed

**REFERENCE ONLY**

REGAL MARINE INDUSTRIES  
 200 ALBERTA DRIVE  
 WILMINGTON, DE 19880  
 TEL: 302.439.1200  
 WWW.REGALMARINE.COM

DRAWING TITLE		REGAL MARINE INDUSTRIES 200 ALBERTA DRIVE WILMINGTON, DE 19880 TEL: 302.439.1200 WWW.REGALMARINE.COM	
36 SC (VJ) Water Tank Routings		ALL DIMENSIONS IN INCHES	
DATE	REV. NO.	DATE	REV. NO.
04/16/2020	-	-	-
DRAWN BY	APPROVED BY	DATE	REV. NO.
DMC	-	04/16/2020	2 OF 4
SHEET NO.		MVA/23F	

# WASTE TANK HOSE ROUTING 1

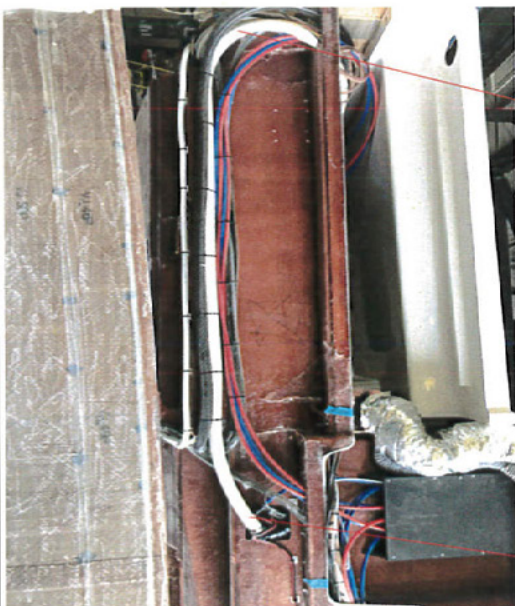
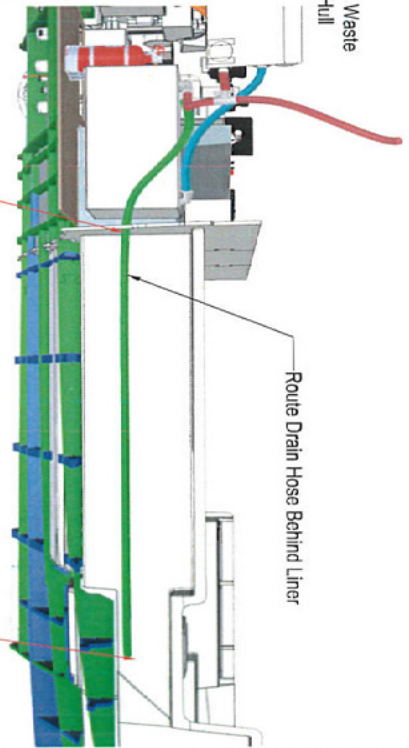
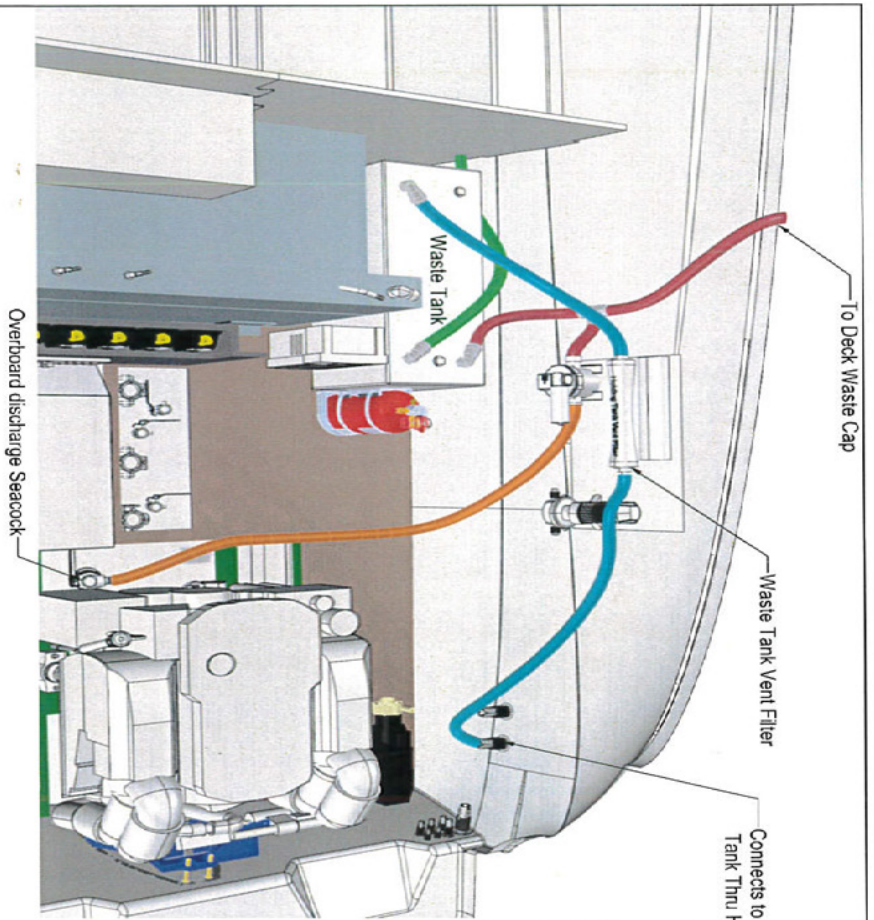

**\*\*Note:** All waste hose routings are  $\varnothing$  1 1/2" Tubing

## REFERENCE ONLY

PREPARED AND CONTROLLED BY: REGAL MARINE INDUSTRIES  
 REGAL MARINE INDUSTRIES IS THE SOLE PROPRIETOR OF REGAL MARINE PRODUCTS AND REPRODUCTION IN WHOLE OR IN PART OF ANYTHING FROM THESE DRAWINGS OR REGAL MARINE PRODUCTS IS PROHIBITED.

 <b>REGAL MARINE INDUSTRIES</b> 228 ATLANTIC DRIVE GULF COAST, ALABAMA 36508 TEL: (904) 391-4400 ALL RIGHTS RESERVED	
DRAWING TITLE <b>36 SC (VJ) Waste Hose Routings</b>	
DATE	REVISION
4/14/2020	-
DRAWN BY	APPROVED BY
DMC	-
PAGE NO.	Part No.
1 OF 1	MVJ23D



# AC HOSE ROUTING 2

## All Routing View

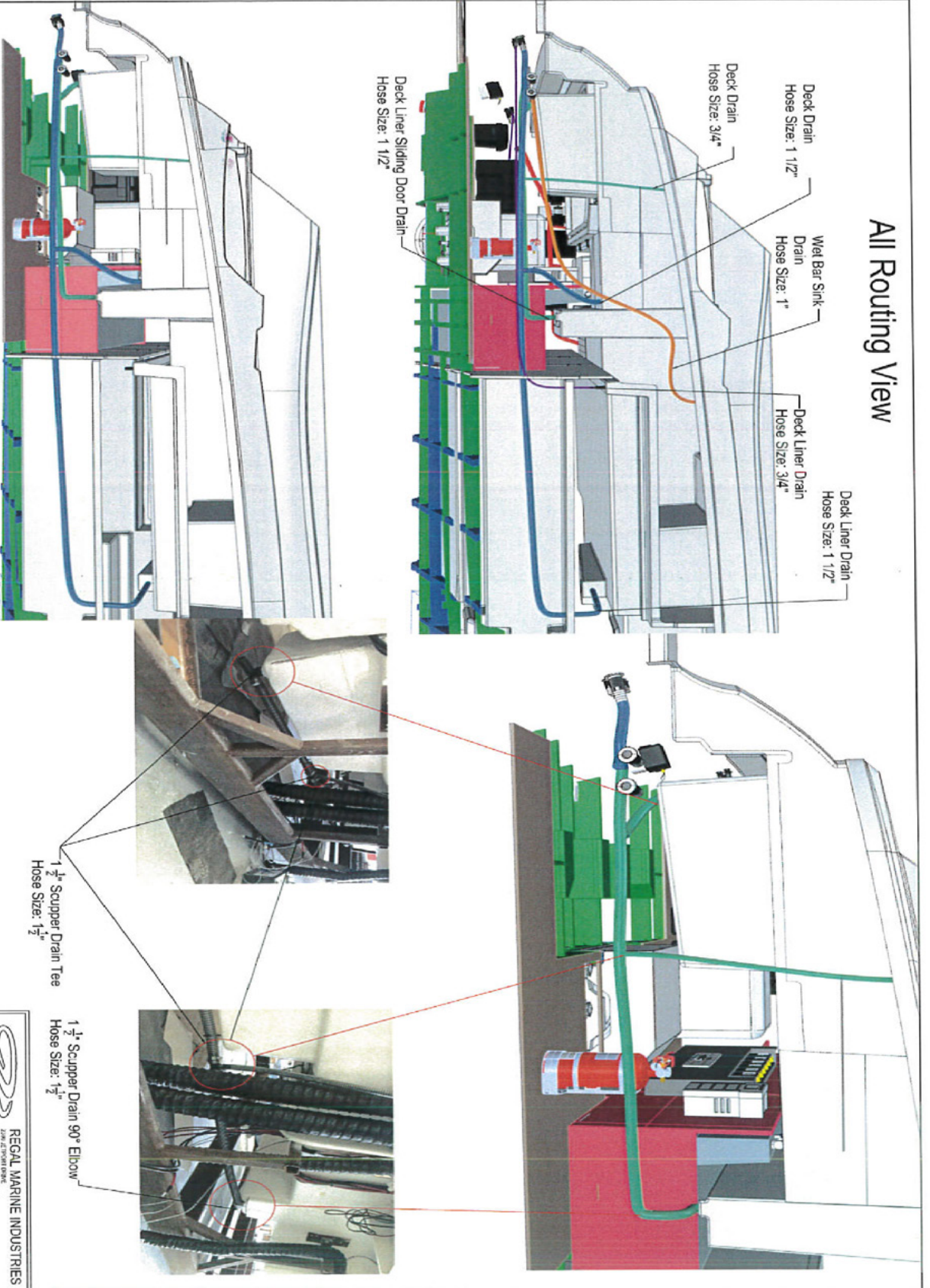

### REFERENCE ONLY

REGAL MARINE INDUSTRIES  
 THE INFORMATION CONTAINED HEREIN IS SHOWN AS THE SOLE PROPERTY OF REGAL MARINE  
 INDUSTRIES. ANY REPRODUCTION IN PART OR AS A WHOLE WITHOUT THE WRITTEN  
 PERMISSION OF REGAL MARINE INDUSTRIES IS PROHIBITED.

 <b>REGAL MARINE INDUSTRIES</b> LOW VOLTAGE SYSTEMS ELECTRICAL DEPARTMENT ALL RIGHTS RESERVED	
PROJECT TITLE:	36 SC (VJ) Cockpit Drain Hose Routings
DATE:	04/22/2020
DESIGNER:	
APPROVED BY:	
DATE:	2 OF 4
PROJECT NO.:	DMC
REV. NO.:	MW23E



# COCKPIT DRAIN HOSE ROUTING 1

## All Routing View

## AFT STBD Cockpit Drains

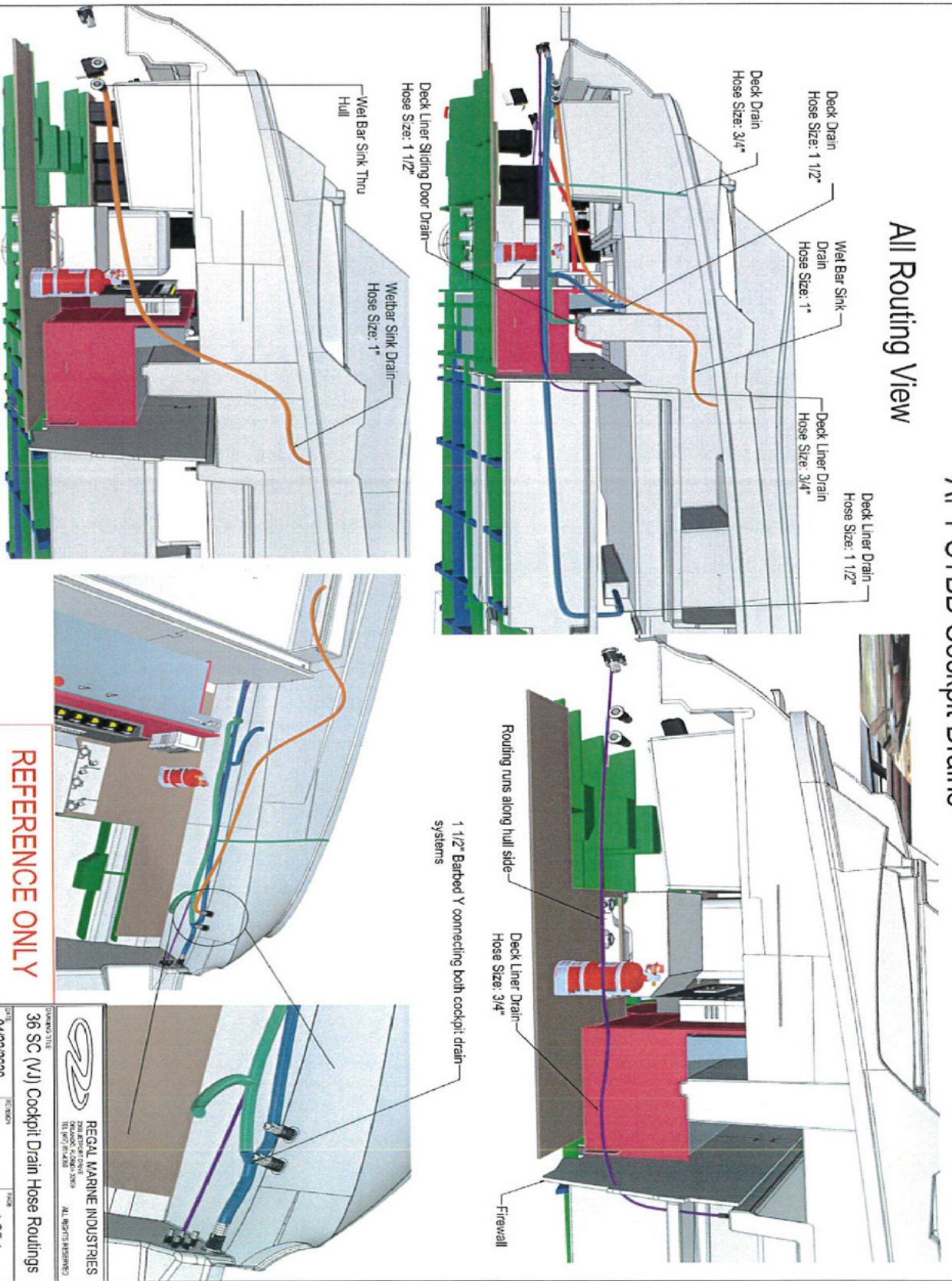

**REFERENCE ONLY**

FOR PARTS AND COMPONENTS, ROUTING AND INSTALLATION, SEE EXPERTS OF REGAL MARINE INDUSTRIES AND REPRODUCTION PARTS OF REGAL MARINE INDUSTRIES. PLEASE REFER TO REGAL MARINE INDUSTRIES FOR DETAILS.

 <b>REGAL MARINE INDUSTRIES</b> 2000 JEFFERSON DRIVE OAKLAND, ALABAMA 36609 TEL: 205/336-8888 ALL RIGHTS RESERVED	
DRAWING TITLE <b>36 SC (WJ) Cockpit Drain Hose Routings</b>	PAGE NO. 1 OF 4
DATE 04/22/2020	DMC NO. MWJ23E
DRAWN BY DMC	CHECKED BY -



# COCKPIT DRAIN HOSE ROUTING 2

## All Routing View

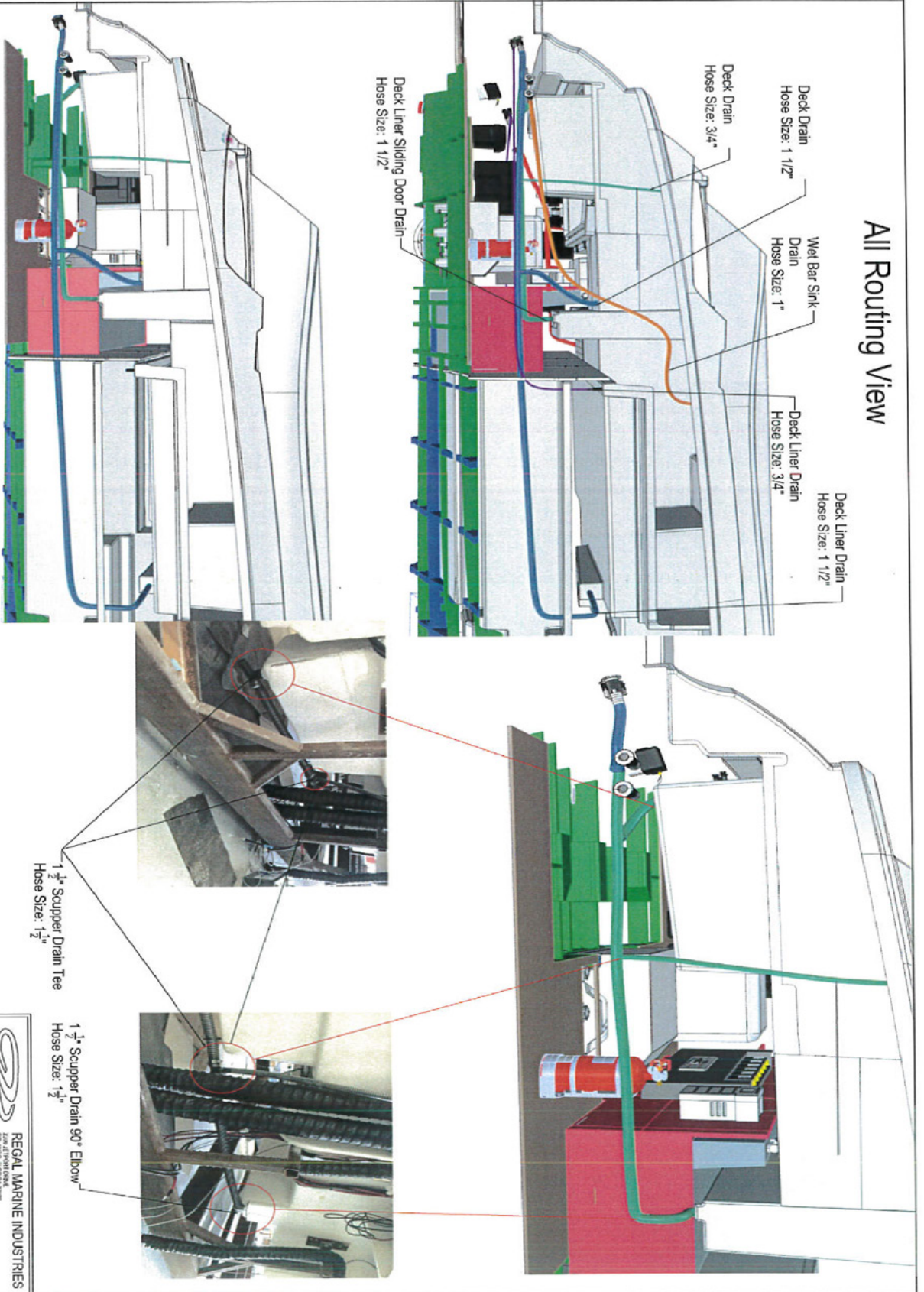

### REFERENCE ONLY

REGAL MARINE INDUSTRIES, INC. IS NOT RESPONSIBLE FOR THE ACCURACY OF THE INFORMATION CONTAINED HEREIN. THE INFORMATION IS PROVIDED AS A SERVICE TO OUR CUSTOMERS AND IS NOT INTENDED TO BE USED AS A SUBSTITUTE FOR PROFESSIONAL ENGINEERING SERVICES.

 <p>REGAL MARINE INDUSTRIES 3650 W. STATE ROAD DAVENPORT, FL 33445 888-827-7673</p>		<p>ALL RIGHTS RESERVED</p>	
DATE	REVISED	PAGE	
04/22/2020	-	2 OF 4	
DESIGNED BY	APPROVED BY	DRAWN BY	SCALE
DMC	-		MW/23E

36 SC (VJ) Cockpit Drain Hose Routings



# COCKPIT DRAIN HOSE ROUTING 3

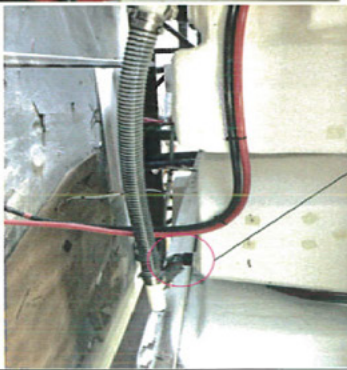
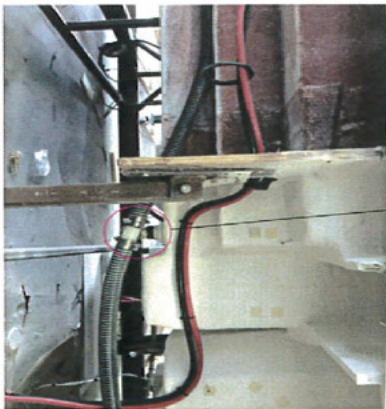
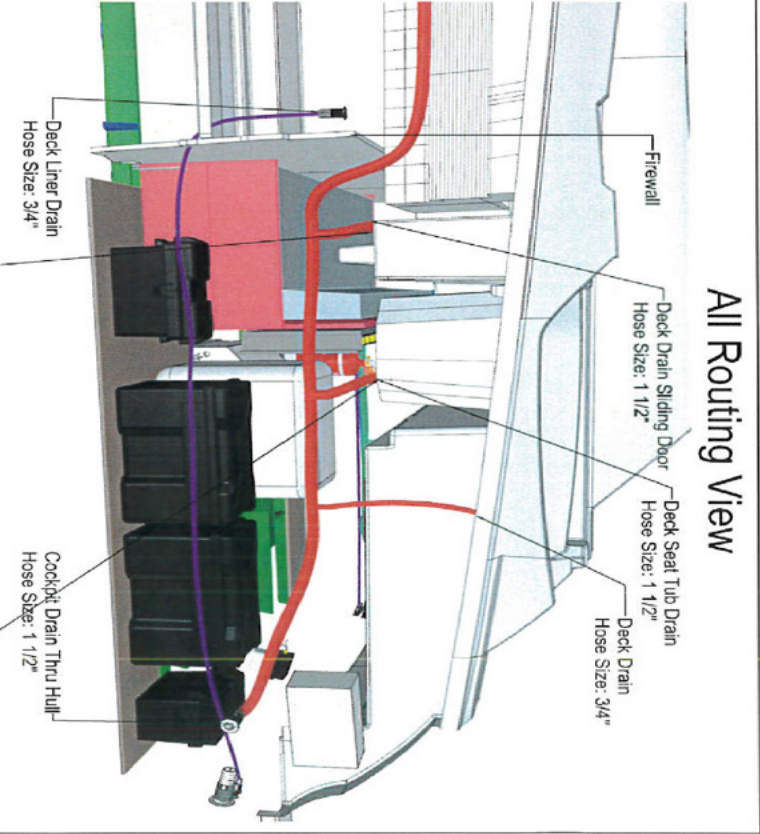
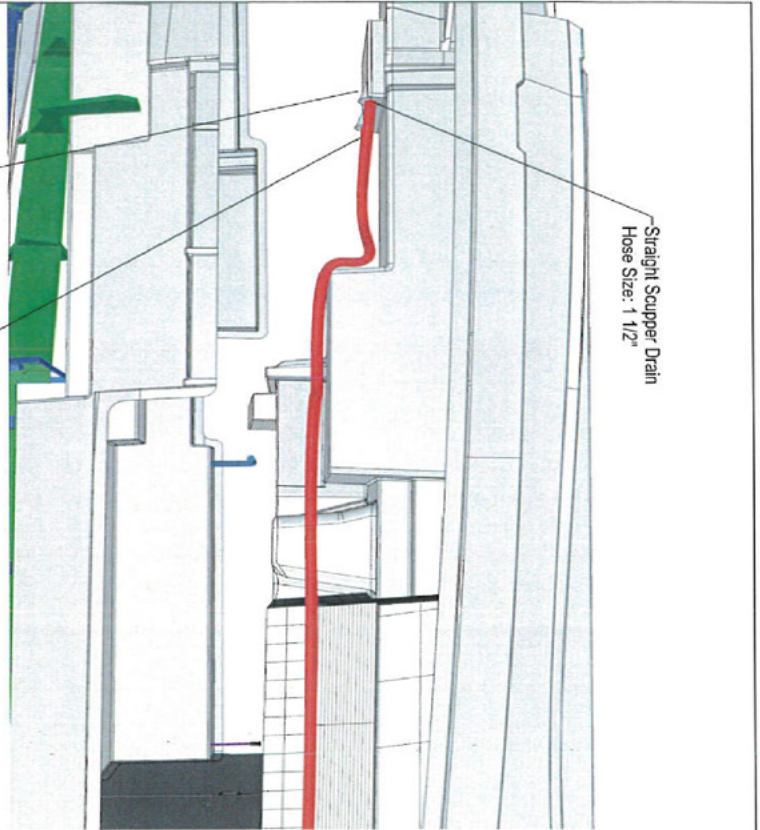

**REFERENCE ONLY**

WORKSHOWN AND CONFIRMED.  
 THIS DRAWING IS NOT TO BE USED FOR CONSTRUCTION OF ANY VESSEL WITHOUT THE WRITTEN PERMISSION OF REGAL MARINE INDUSTRIES.

 <p><b>REGAL MARINE INDUSTRIES</b>                  2200 AIRPORT DRIVE                  CHANDLER, AZ 85226                  TEL: (480) 754-2200</p>		<p>ALL RIGHTS RESERVED</p>	
<p><b>36 SC (WJ) Cockpit Drain Hose Routings</b></p>			
DATE	REVISION	PAGE	
04/22/2020	-	3 OF 4	
DESIGNER	DRAWN BY	CHECKED BY	DATE
DMC	DMC		MVJ23E

# COCKPIT DRAIN HOSE ROUTING 4

## Bow Cockpit Drains



1 1/2" Scupper Drain  
90° Elbow

3/4" Scupper Drain  
90° Elbow

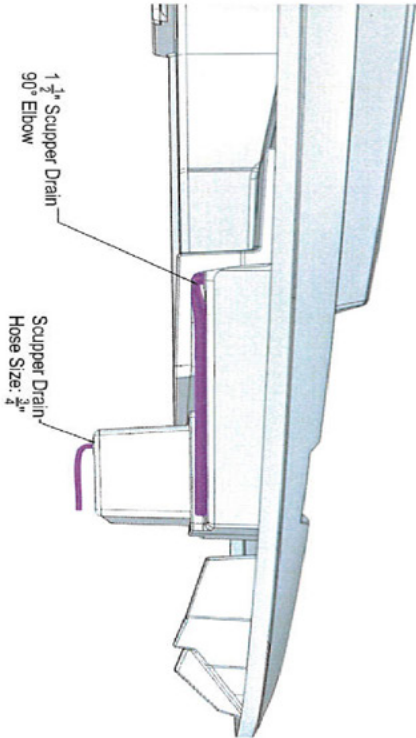

1 1/2" Scupper Drain  
90° Elbow

Scupper Drain  
Hose Size: 3/4"

**REFERENCE ONLY**

REGAL MARINE INDUSTRIES  
RESERVES THE RIGHT TO CHANGE THE CONTENTS OF THIS DRAWING  
WITHOUT NOTICE. ANY REPRODUCTION OF THIS DRAWING WITHOUT THE EXPRESS  
PERMISSION OF REGAL MARINE INDUSTRIES IS PROHIBITED.



**REGAL MARINE INDUSTRIES**  
10000 W. 10th Street, Suite 100  
Tulsa, Oklahoma 74116  
Tel: 918.437.8300

ALL RIGHTS RESERVED

DRAWING TITLE: **36 SC (W) Cockpit Drain Hose Routings**

DATE: **04/22/2020**

REVISED:

-

SIZE: **4 OF 4**

DRAWN BY: **DMC**

APPROVED BY:

-

DATE: **MV123E**



# COLLECTION BOX HOSE ROUTING 1

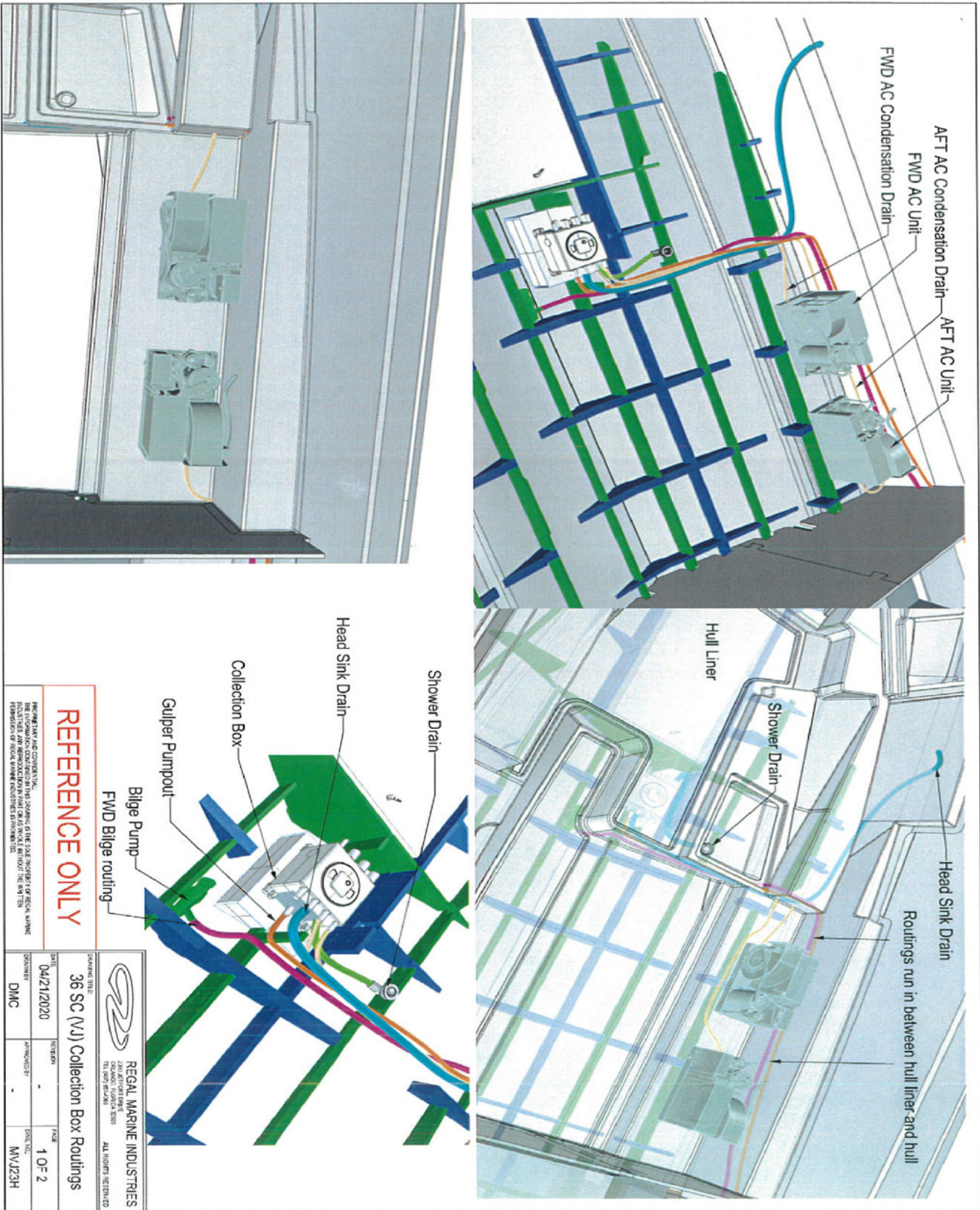



# COLLECTION BOX HOSE ROUTING 2

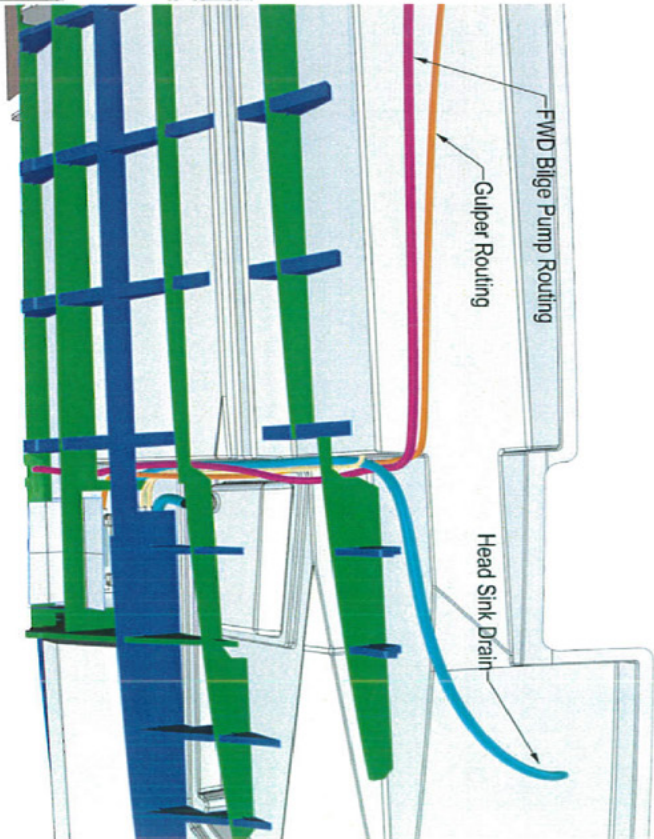
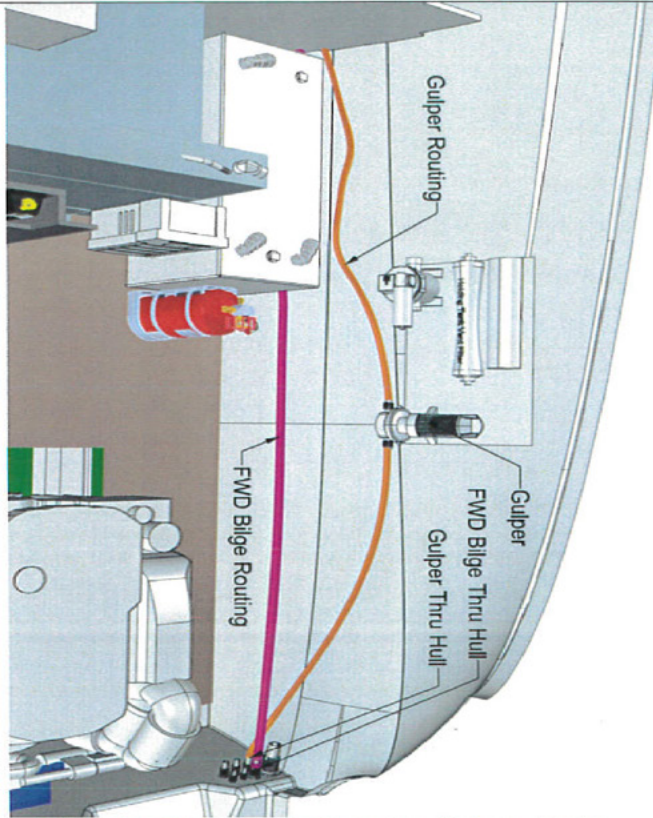

**REFERENCE ONLY**

REGAL MARINE INDUSTRIES  
 THE INFORMATION CONTAINED IN THIS DRAWING IS THE PROPERTY OF REGAL MARINE INDUSTRIES. IT IS TO BE USED ONLY FOR THE PROJECT AND VESSEL IDENTIFIED HEREIN. NO PART OF THIS DRAWING IS TO BE REPRODUCED OR TRANSMITTED IN ANY FORM OR BY ANY MEANS, ELECTRONIC OR MECHANICAL, INCLUDING PHOTOCOPYING, RECORDING, OR BY ANY INFORMATION STORAGE AND RETRIEVAL SYSTEM.

 <b>REGAL MARINE INDUSTRIES</b> COMPANY FORMED 2008 16,4971 STANLEY ALL RIGHTS RESERVED	
DATE	04/21/2020
DESIGNED BY	DMC
APPROVED BY	
PROJECT	36 SC (V) Collection Box Routings
SHEET NO.	2 OF 2
DATE	MM/23H

# SUMP (BILGE) LAYOUT 1

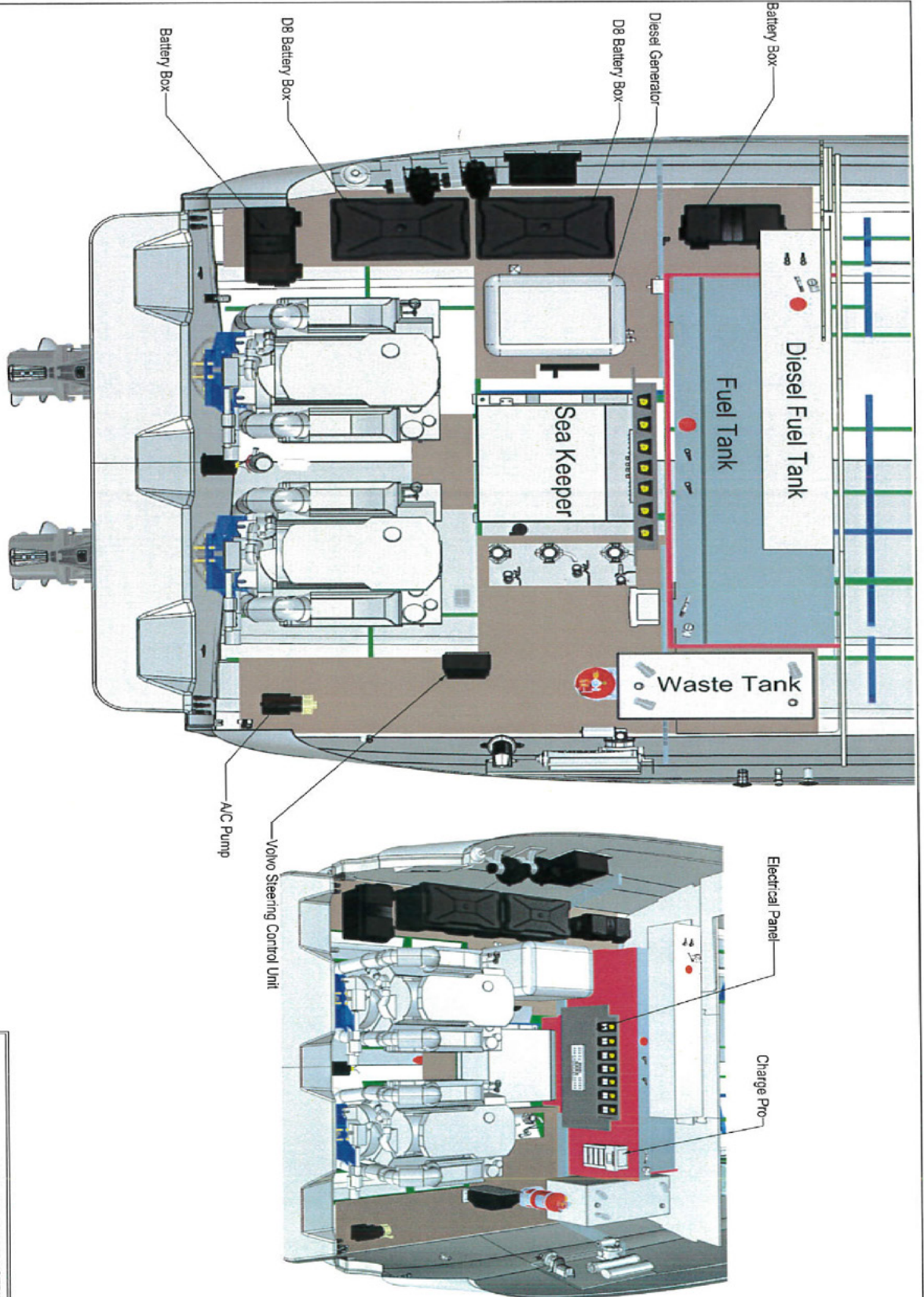

**REFERENCE ONLY**

THIS DOCUMENT IS A COMPONENT OF THE REGAL MARINE INDUSTRIES 36 SC (N) SUMP LAYOUT. THE INFORMATION CONTAINED HEREIN IS THE SOLE PROPERTY OF REGAL MARINE INDUSTRIES. ANY REPRODUCTION, STORAGE, OR TRANSMISSION OF THIS INFORMATION WITHOUT THE WRITTEN PERMISSION OF REGAL MARINE INDUSTRIES IS PROHIBITED.

 <b>REGAL MARINE INDUSTRIES</b> 2000 LITTLEPORT DRIVE DANMORCO, TEXAS 75028 TEL: 972.781.1800 FAX: 972.781.1801	
DRAWING TITLE <b>36 SC (N) Sump Layout</b>	DATE 4/14/2020
DRAWN BY DMC	CHECKED BY -
PROJECT NO. MVL23B	PAGE 1 OF 5



# SUMP (BILGE) LAYOUT 2

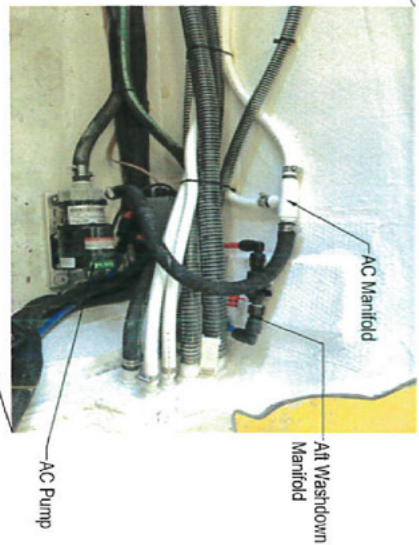
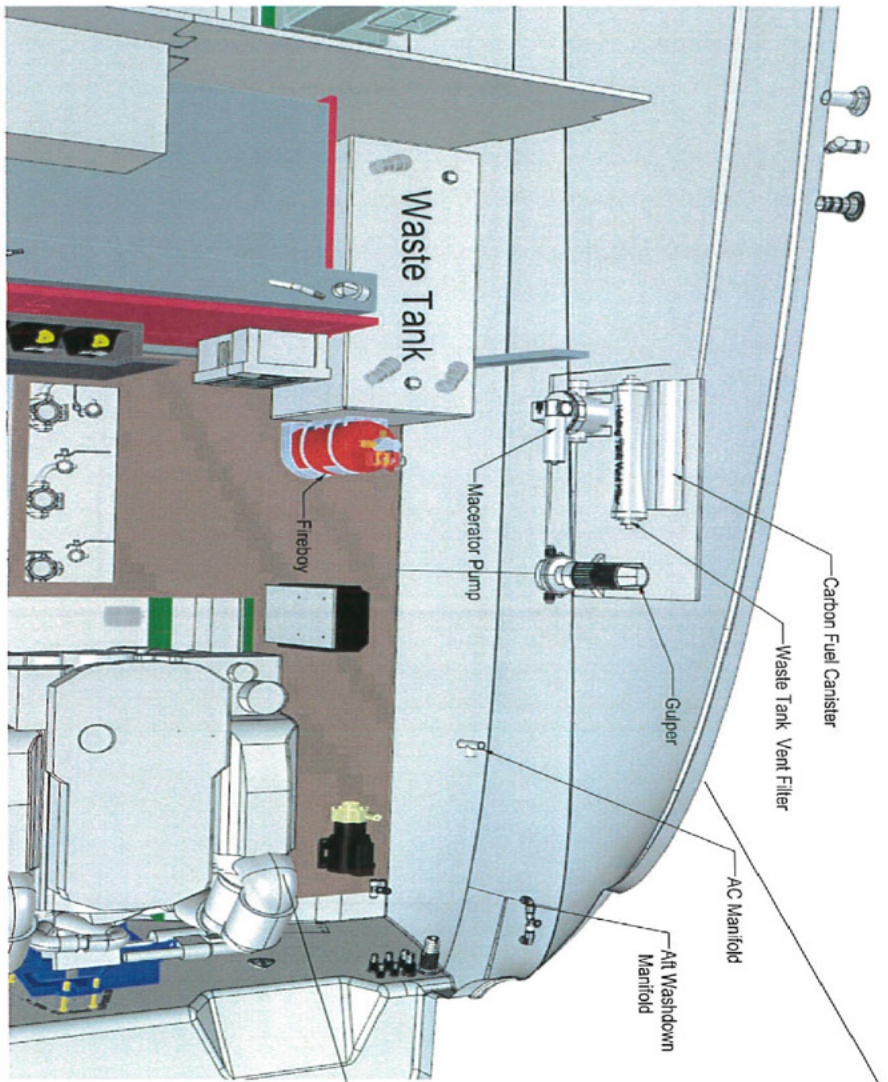

**REFERENCE ONLY**

THIS DRAWING IS A REFERENCE ONLY. THE INFORMATION CONTAINED HEREIN IS FOR INFORMATIONAL PURPOSES ONLY AND DOES NOT CONSTITUTE A WARRANTY, REPRESENTATION OR OPINION OF REGAL MARINE INDUSTRIES. ANY REPRODUCTION OR TRANSMISSION OF THIS INFORMATION WITHOUT THE WRITTEN PERMISSION OF REGAL MARINE INDUSTRIES IS PROHIBITED.

 <b>REGAL MARINE INDUSTRIES</b> 2200 ZEPHYRUS DRIVE ORLANDO, FLORIDA 32838 TEL: 407-321-5500		ALL RIGHTS RESERVED ©	
<b>36 SC (V) Sump Layout</b>			
DATE:	REVISED:	SIZE:	
4/14/2020	-	2 OF 5	
DRAWN BY:	APPROVED BY:	SCALE:	
DMC	-		MV123B

# SUMP (BILGE) LAYOUT 3

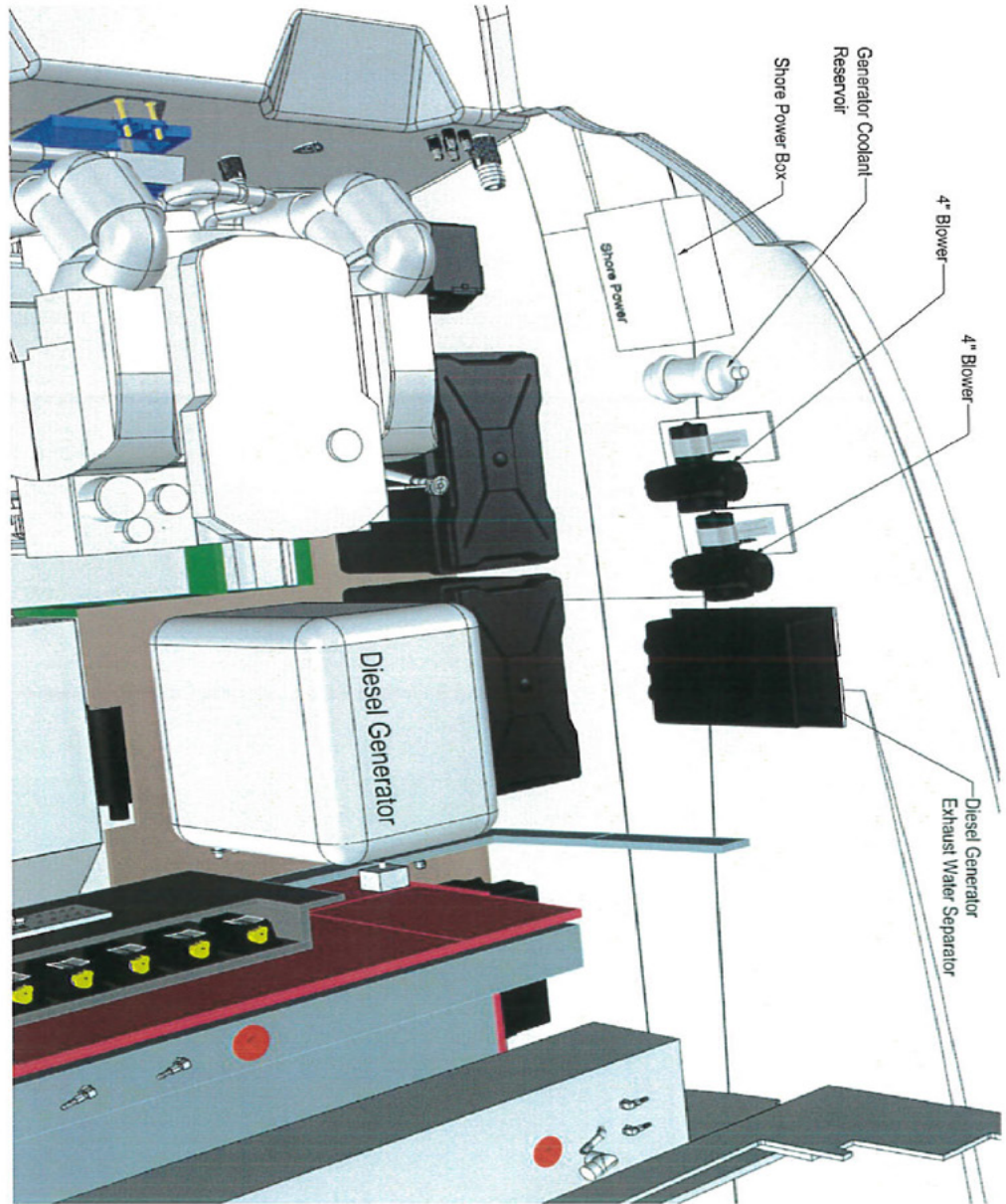

**REFERENCE ONLY**

REGAL MARINE INDUSTRIES, INC. IS NOT RESPONSIBLE FOR ANY DAMAGE TO THE VESSEL OR EQUIPMENT OR FOR THE LOSS OF LIFE OR PROPERTY OR FOR THE LOSS OF REVENUE OR PROFITS OR FOR THE LOSS OF BUSINESS OR REPUTATION OR FOR THE LOSS OF DATA OR FOR THE LOSS OF ANY OTHER INFORMATION OR FOR THE LOSS OF ANY OTHER INFORMATION OR FOR THE LOSS OF ANY OTHER INFORMATION.

 <p><b>REGAL MARINE INDUSTRIES</b>          2000 N. W. 10th Ave., Ft. Lauderdale, FL 33309          TEL: (954) 345-1000</p>		<p>ALL RIGHTS RESERVED</p>	
<p>36 SC (V) Sump Layout</p>			
DATE	REVISED BY	DATE	REVISED BY
4/14/2020	-	3 OF 5	-
DRAWN BY	APPROVED BY	DATE	REVISED BY
DMC	-	MM/23B	-



# SUMP (BILGE) LAYOUT 4

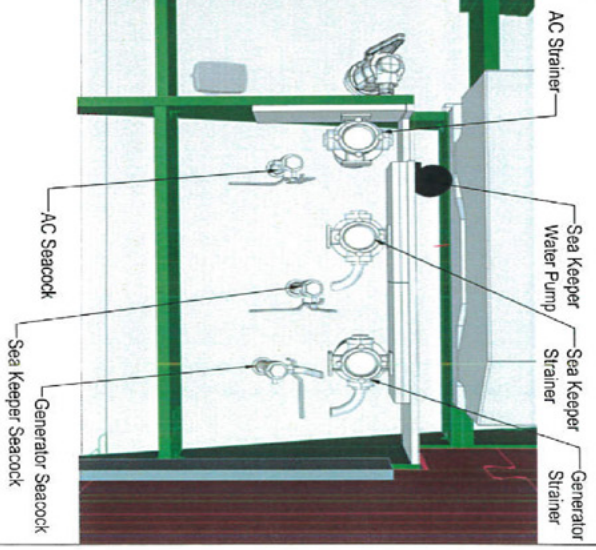
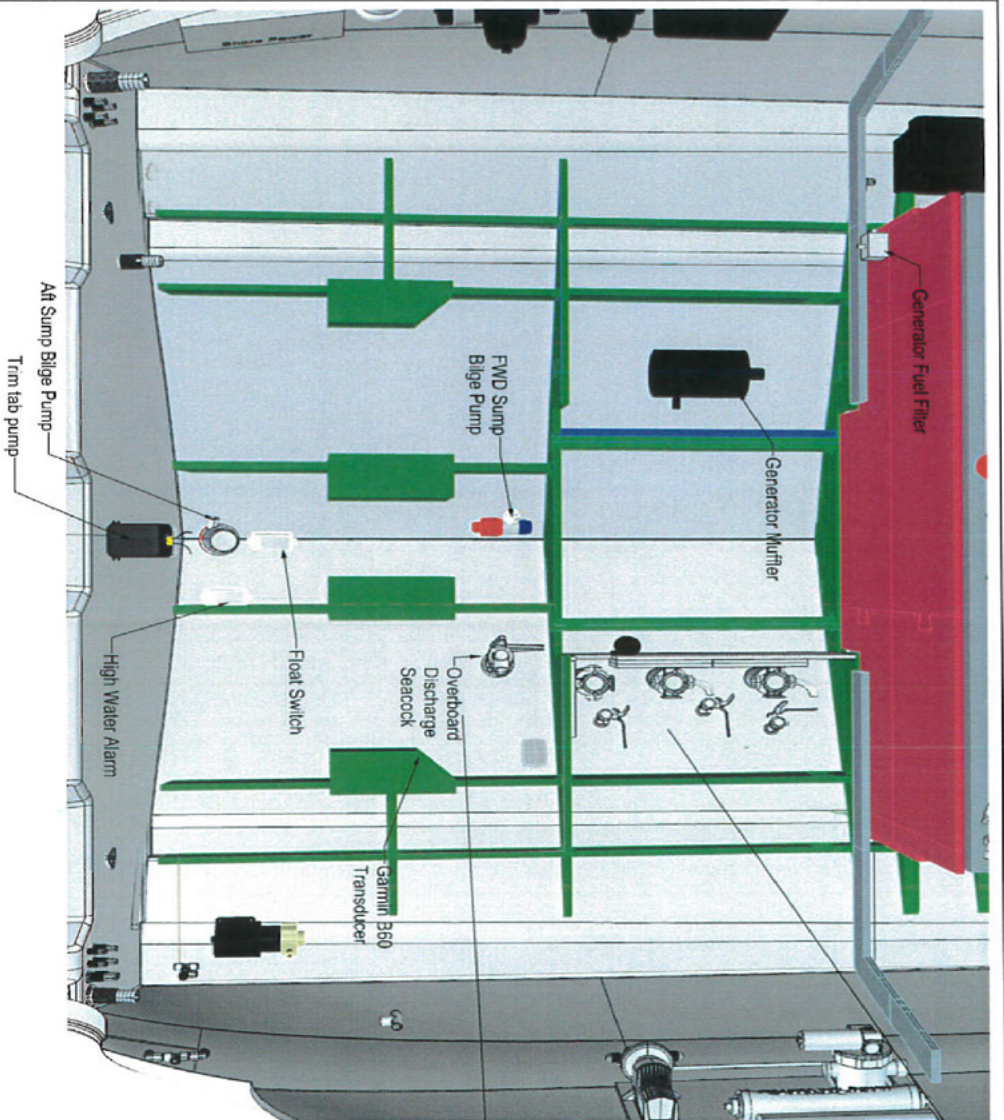

Seacock and Transducer Placement

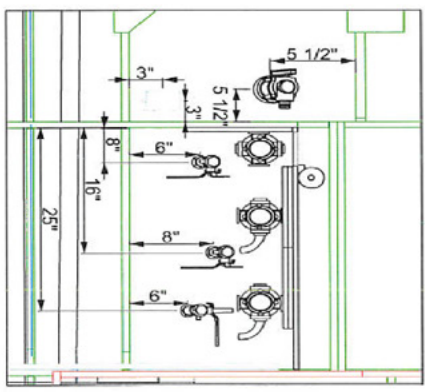

**REFERENCE ONLY**

NOTED IN THE CONSTRUCTION PERMITS AND THIS DRAWING IS THE SOLE PROPERTY OF REGAL MARINE INDUSTRIES. ANY REPRODUCTION, PART OR AS WHOLE IN THE VESSEL, WITHOUT THE WRITTEN PERMISSION OF REGAL MARINE INDUSTRIES IS PROHIBITED.

<p><b>REGAL MARINE INDUSTRIES</b>  <small>THE ORIGINAL DESIGNER OF THE WORLD'S MOST ADVANCED YACHTS</small>  <small>13200 131ST STREET, SEASIDE, CA 94135</small></p>		<p>44-182011-REVISED</p>	
<p><b>36 SC (W) Sump Layout</b></p>			
DATE:	4/14/2020	REVISION:	4 OF 5
DESIGNER:	DMC	MANUFACTURED BY:	MAV23B

# HULL HARDWARE STARBOARD

STBD Side

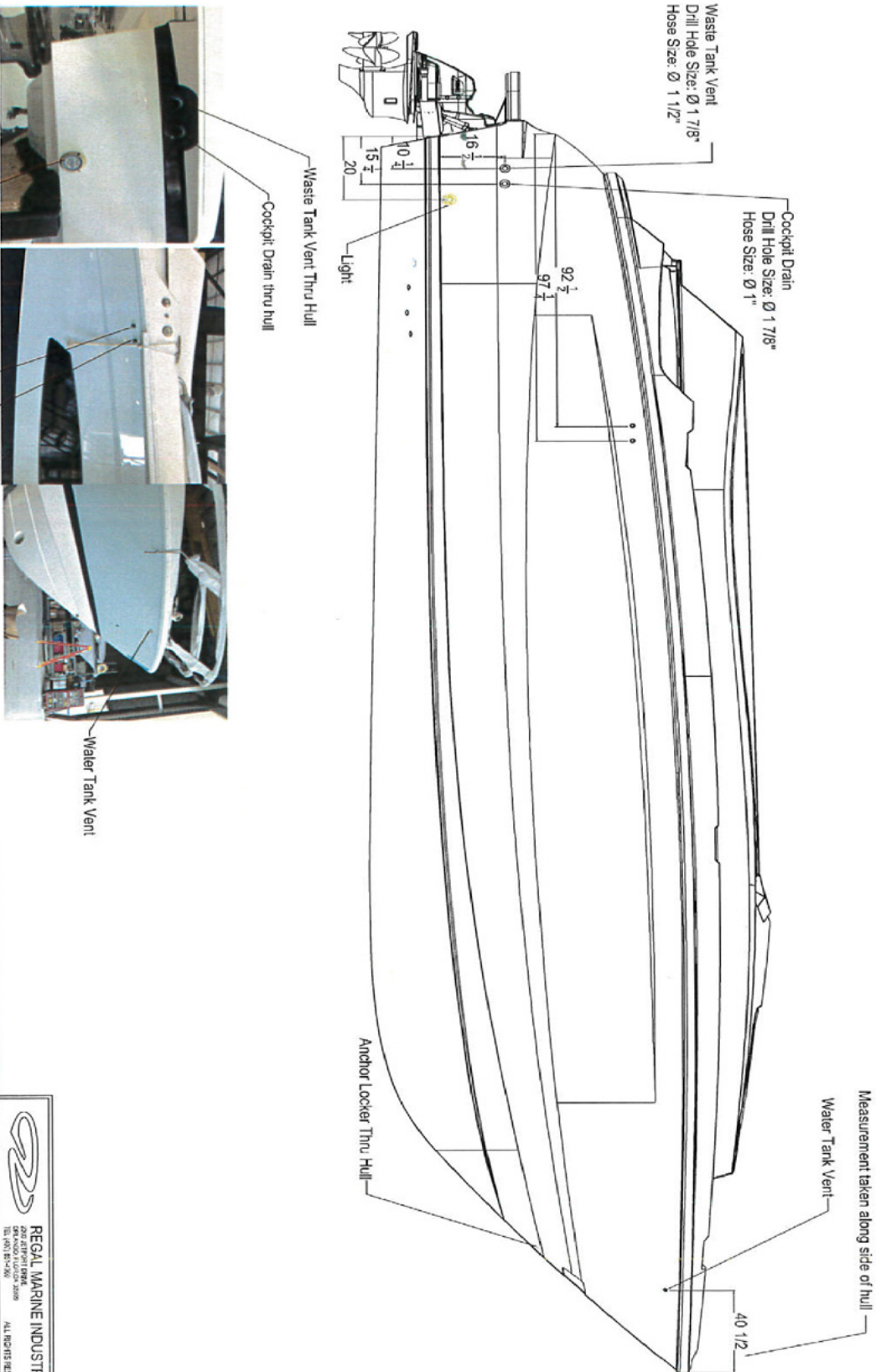

Waste Tank Vent Thru Hull

Cockpit Drain thru hull

Light

Anchor Locker Thru Hull

Water Tank Vent

Measurement taken along side of hull

40 1/2

Waste Tank Vent  
Drill Hole Size: Ø 1 7/8"  
Hose Size: Ø 1 1/2"

Cockpit Drain  
Drill Hole Size: Ø 1 7/8"  
Hose Size: Ø 1"

Underwater Light

Diesel Fuel Tank Vent

Water Tank Vent

**REFERENCE ONLY**

REGAL MARINE AND CONCEPTUAL, INC. IS NOT RESPONSIBLE FOR THE ACCURACY OF THE INFORMATION CONTAINED IN THIS DRAWING. THE INFORMATION CONTAINED IN THIS DRAWING IS THE SOLE PROPERTY OF REGAL MARINE AND CONCEPTUAL, INC. AND IS TO BE USED ONLY FOR THE PROJECT AND VESSEL IDENTIFIED IN THE DRAWING. REGAL MARINE AND CONCEPTUAL, INC. IS NOT RESPONSIBLE FOR ANY OTHER USES OF THIS DRAWING.

 <p><b>REGAL MARINE INDUSTRIES</b> 202 ALBERTA DRIVE TEL: 903.834.4600 ALL RIGHTS RESERVED</p>	
ORDER TITLE	36 SC (VJ) Hull Hardware
DATE	04/20/2020
DESIGNER	DMC
PRICE	1 OF 3
DATE	04/20/2020
REV	MWJ24B

# HULL HARDWARE PORT

Port Side



Bow View

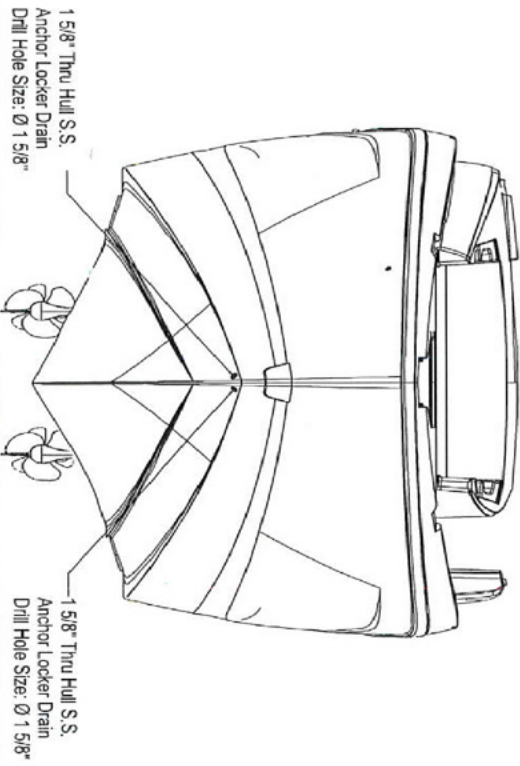

**REFERENCE ONLY**

REGAL MARINE INDUSTRIES  
 THE INFORMATION CONTAINED HEREIN IS FOR REFERENCE ONLY AND IS NOT A CONTRACT. THE INFORMATION IS PROVIDED AS IS WITHOUT WARRANTY OF ANY KIND, EXPRESS OR IMPLIED, INCLUDING BUT NOT LIMITED TO THE WARRANTIES OF MERCHANTABILITY, FITNESS FOR A PARTICULAR PURPOSE AND NONINFRINGEMENT OF THIRD PARTY RIGHTS.

 <b>REGAL MARINE INDUSTRIES</b> 20000 W. Highway 100 Pompano Beach, FL 33069 TEL: 954.781.4300		ALL RIGHTS RESERVED	
QUANTITY	DATE	ISSUE	PRICE
DMC	04/20/2020	2 OF 3	
DRAWING TITLE <b>36 SC (VJ) Hull Hardware</b>		PART NO. <b>MVJ24B</b>	



# HULL HARDWARE AFT

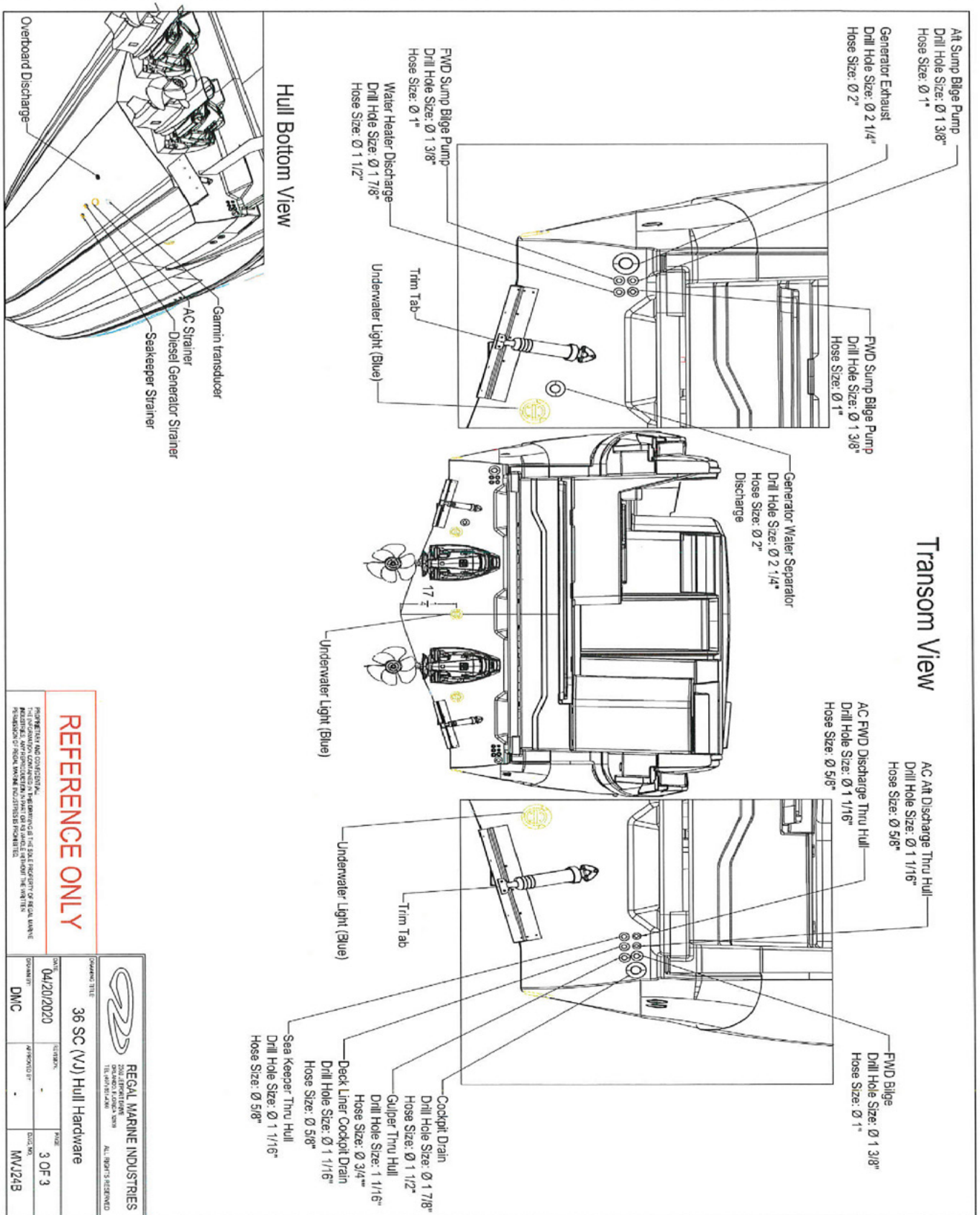

**REFERENCE ONLY**

REGAL MARINE INDUSTRIES, INC.  
 THE INFORMATION CONTAINED IN THIS DRAWING IS THE SOLE PROPERTY OF REGAL MARINE  
 INDUSTRIES, INC. AND IS TO BE USED FOR THE MANUFACTURE OF REGAL MARINE PRODUCTS ONLY.  
 REGAL MARINE INDUSTRIES, INC. IS NOT RESPONSIBLE FOR ANY REVISIONS OR CHANGES TO THIS DRAWING.

 <p><b>REGAL MARINE INDUSTRIES</b>                  2001 ALPHEUS DRIVE                  DANIA, FLORIDA 33428                  TEL: 407-253-1800 FAX: 407-253-1801</p>		DRAWING TITLE <p><b>36 SC (VJ) Hull Hardware</b></p>	
DATE	04/20/2020	DESIGNER	3 OF 3
DRAWN BY	DMC	APPROVED BY	MWJ248



# GRAND COUPE UPHOLSTERY IDENTIFIER

Bundle	Assembly	Description
1	UVK01A	AFT CABIN STBD CUSHION
2	UVK01B	AFT CABIN STBD CUSHION FRAME
3	UVK01C	AFT CABIN FILLER CUSHION
4	UVK01D	AFT CABIN PORT CUSHION
5	UVK01E	AFT CABIN PORT BACKREST
6	UVK01F	AFT CABIN A/C PANEL
7	UVK01G	AFT CABIN STBD FWD CLOSEOUT
8	UVK01H	AFT CABIN WALL PANELS
9	UVK01J	AFT CABIN VALANCE
10	UVK01K	AFT CABIN STBD WINDOW MUFF
11	UVK01L	AFT CABIN PORT WINDOW MUFF
12	UVK01M	AFT CABIN TV PANEL
13	UVK01N	
14	UVK01P	
15	UVK02A	MID CABIN CUSHION
16	UVK02B	MID CABIN BACKREST
17	UVK02C	ATRIUM LIGHT PANEL
18	UVK02D	V-BERTH BUNK KEEPER
19	UVK02E	V-BERTH PORT SHELF
20	UVK02F	V-BERTH STBD SHELF
21	UVK02G	V-BERTH HEADBOARD
22	UVK02H	V-BERTH LIGHTING PANELS
23	UVK02J	V-BERTH BULKHEAD
24	UVK02K	V-BERTH BUNK
25	UVK02L	V-BERTH PORT HULL SIDE VINYL
26	UVK02M	V-BERTH STBD HULL SIDE VINYL
27	UVK02N	V-BERTH STBD FWD CABINET
28	UVK02P	V-BERTH TV WALL
29	UVK02Q	MID CABIN HEAD VINYL
30	UVK04A	HEAD WALL PANELS
31	UVK04B	SHOWER DOOR TRACK
32	UVK04C	HEAD LIGHTING PANEL
33	UVK04D	HEAD WALL PANELS
34		
35		
36		
37		
38		
39		

*\*Note that the identifier can be used to assist in ordering upholstery needs throughout the life of the vessel*

36 GRAND COUPE UPHOLSTERY IDENTIFIER

Udble	Assembly	Description	Sub	Vinyl
40	UVK06A	BOW FWD CUSHION		
41	UVK06B	BOW PORT CUHION		
42	UVK06C	BOW STBD CUSHION		
43	UVK06D	BOW STBD CUP HOLDER PANEL		
44	UVK06E	BOW AFT CUSHION		
45	UVK06F	BOW PORT CUP HOLDER PANEL		
46	UVK06G	BOW AFT BACKREST		
47	UVK06H			
48	UVK06J			
49	UVK14A	ATRIUM FWD PANEL		
50	UVK14B	ATRUIM PORT PANEL		
51	UVK14C	COMPANION G.O.V.		
52	UVK14D	ENTRY DOOR MUFF		
53	UVK13A	HELM STORAGE		
54	UVK13B	DASH		
55	UVK13C	SHIFTER		
56	UVK13D	HELM SEAT		
57	UVK13E	DASH VISOR		
58	UVK15A	SALON FWD CUSHION (STD)		
59	UVK15B	SALON FWD BACKREST (STD)		
60	UVK15C	SALON FWD FLIP FLOP BACKREST (STD)		
61	UVK15D	SALON FWD FLIP FLOP BACKREST (OPT)		
62	UVK15E	SALON FWD BASE PANEL (STD)		
63	UVK15F	SALON AFT BACKREST (W/O)		
64	UVK15G	SALON AFT CUSHION (W/O)		
65	UVK15H	SALON AFT BACKREST (W/SD)		
66	UVK15J	SALON AFT CUSHION (W/SD)		
67	UVK15K	SALON ARMREST (W/SD)		
68	UVK15L	PATIO BACKREST (W/SD)		
69	UVK15M	PATIO ARMREST (W/SD)		
70	UVK15N	PATIO CUSHION (W/SD)		
71	UVK15P	PATIO BACKREST (W/SD)		
72	UVK15Q	PATIO OB CUSHION (W/O)		
73	UVK15R	PATIO CENTER CUSHION (W/O)		
74	UVK15S	PATIO IB CUSHION (W/O)		
75	UVK15T	PATIO FLIP FLOP BACKREST (W/O)		
76	UVK15U	SALON T.V.		
77	UVK15V	PATIO HARDTOP PANELS		
78	UVK15W	SALON HARDTOP PANELS		
79				
80	UVK17A	ENGINE HATCH PORT CUSHION		
81	UVK17B	ENGINE HATCH CENTER CUSHION		
82	UVK17C	ENGINE HATCH STBD CUSHION		
83	UVK17D	ENGINE HATCH BACKREST		
84	UVK17E	ENGINE HATCH FWD PANEL		
85	UVK15Z	SALON STBD COLUMN MUFF (W/SD)		
86	UVK15Y	SALON PORT COLUMN MUFF (W/SD)		
87	UVK15YA	SALON STBD COLUMN MUFF (W/O)		
88	UVK15ZA	SALON PORT COLUMN MUFF (W/O)		
89				
90				

