



REGAL 38GC/38XO OWNER'S MANUAL



JUNE 2020 REVISION

CALIFORNIA PROPOSITION 65

Boats manufactured for use in California for model year 2018 and after meet the California EVAP Emissions regulation for spark-ignition marine watercraft. Boats meeting this requirement will have a label affixed near the helm.

WARNING

Operating, servicing and maintaining a recreational marine vessel can expose you to chemicals including engine exhaust, carbon monoxide, phthalates, and lead, which are known to the State of California to cause cancer and birth defects or other reproductive harm. To minimize exposure, avoid breathing exhaust, service your vessel in a well-ventilated area and wear gloves or wash your hands frequently when servicing this vessel. For more information go to: www.P65warnings.ca.gov/marine.

The fuel system in this boat complies with U.S. EPA mandated evaporative emission standards at time of manufacture using certified components.

MANUFACTURER'S WARRANTY COVERAGE

This evaporative emission control system is warranted for two years. If any evaporative emission-related part on your spark-ignition marine watercraft is defective, the part will be repaired by Regal Marine Industries, Inc.

OWNER'S MANUAL RESPONSIBILITIES

- As the spark-ignition marine watercraft owner, you are responsible for the performance of the required maintenance listed in your owner's manual. Regal Marine Industries, Inc. recommends that you retain all receipts covering maintenance on your spark-ignition marine watercraft, but Regal Marine Industries, Inc. cannot deny warranty solely on the lack of receipts.
- As the owner, you should be aware that Regal Marine Industries, Inc. may deny you warranty coverage of your spark-ignition marine watercraft or a part has failed due to abuse, neglect, or improper maintenance or unapproved modifications.
- You are responsible for presenting your spark-ignition marine watercraft to a Regal Marine Industries, Inc. distribution center or a service center as soon as the problem exists. The warranty repairs should be completed in a reasonable amount of time, not to exceed 30 days. If you have any questions regarding your warranty coverage, you should contact Regal Marine Industries, Inc. at 407-851-4360.

Introduction

Boating is becoming more popular each and every year. There are numerous types of recreational vessels on our waterways today involved in an every growing number of activities. Therefore, as a Regal boat owner it is of the highest priority to learn about general boating practices before operating your vessel.

Your Regal dealer will answer many questions and provide valuable “hands on” information during the completion of the new boat delivery process. In addition, your dealer has received special factory training on the product line and his services should be employed to solve any technical problems and periodic maintenance beyond the scope of this manual. Your Regal dealer carries a line of factory approved parts and accessories.

Your Regal dealer can provide information regarding national training organizations such as the U.S. Power Squadron and United States Coast Guard Auxiliary. Along with other organizations and literature, they can help build your “boating savvy” by developing the necessary skills and awareness to be a safe and confident skipper.

Also, your local library can assist in providing recommended boating literature such as Chapman Piloting Seamanship & Boat Handling by Elbert S. Maloney. Also, boating information is available on the internet.

Remember, waterway conditions can change in a heartbeat. Knowing how to react quickly comes from experience and knowledge which can be gained through boating education.

Welcome aboard!

Welcome to Regal

I know I speak for everyone at Regal when I welcome you to the ever-growing family of Regal boat owners. You've chosen a boat that is recognized worldwide for its standard of excellence. Each step in construction has been carefully scrutinized to assure safety, performance, reliability and comfort for both your passengers and yourself.

Your yacht is certified by the National Marine Manufacturers Association. It also complies with the applicable standards set by the United States Coast Guard , American Boat and Yacht Council and the International Marine Certification Institute. Your Regal boat was built with the same attention to detail and quality of construction that we would expect in a craft we would purchase ourselves.

Whether you're a veteran boater or a newcomer, we strongly urge you to read this owner's manual thoroughly. Familiarize yourself with the various components of your vessel, and heed the safety precautions noted herein.

If you have questions that are not covered in this manual, please consult your authorized Regal dealer for assistance, phone the Regal factory at 407-851-4360 or E-mail us at www.regalboats.com.

Thank you, and welcome to the "World of Regal !"

Duane Kuck
President & CEO

Our Mission

With God's Help and a Steadfast Commitment to Integrity, We will Develop a Team of Exceptional People and Relationships to Provide Exceptional Customer Satisfaction.

Table Of Contents

2	Notes
3	Introduction
4	Welcome to Regal
6	Chapter 1 - General Vessel Information
19	Chapter 2 - Safety On Board
42	Chapter 3 - Rules Of The Road
53	Chapter 4 - Systems
152	Chapter 5 - Engines & Controls
153	Part A-Gas Stern Drive
170	Part B-Outboard
199	Part C-Diesel Stern Drive
215	Chapter 6 - Vessel Operation
229	Chapter 7 - Auxiliary Equipment Operation
270	Chapter 8 - Care & Maintenance
288	Chapter 9 - Troubleshooting
295	Chapter 10 - Storage & Winterization
301	Chapter 11- Glossary & Index
307	Chapter 12 - Technical

Chapter 1

General Vessel Information

Regal Owner's Manual



Your Regal owner's manual has been compiled with information to assist you in operating your craft with safety and pleasure. This manual targets specific details of Regal related systems and components along with their location, operation and maintenance that normally are not found in the vendor information.

In addition, any supplier related equipment information is located within the owner's information packet.

Read and understand each components owners manual before operating the equipment as the manuals always contain important safety instructions.

There are instances where stern drive and outboard information is mixed. In such cases wording is used at that point to differentiate between the products for the reader.

The Regal owner's manual should not be thought of as a complete shop manual. Besides the system chapters, there is troubleshooting information devoted to select current standard and optional equipment. In addition, refer to the engine and generator (if installed) operator's manuals. More detailed information exists in the owner's packet associated with the engine and drive components.

Remember that your Regal dealer has received special factory training and his services should be employed to solve more technical problems. Call 407-851-4360 or go to the internet at regalboats.com to find the closest Regal Yacht dealership.

In keeping with its commitment to improvement Regal Marine Industries, Inc. is continually upgrading the product line. Regal notes that all dimensions, specifications, models, standard and optional equipment are subject to change without notice at any time.

	WARNING
<p>PREVENT INJURY, DEATH, OR PROPERTY DAMAGE! READ AND UNDERSTAND THE REGAL OWNER'S MANUAL BEFORE ATTEMPTING TO OPERATE THE VESSEL.</p>	

Engine/Propulsion Manual



Your engine and propulsion manual are normally found in the owner's information packet. This manual addresses specific engine and drive fundamentals of operation. Also, it describes the many systems found on today's engines and drive units. Furthermore, instruments, controls, maintenance, troubleshooting, storage along with calibrations and settings.

Other engine and drive questions can be answered by your closest Regal Yacht dealer or by contacting the engine manufacturer on the internet.



WARNING

PREVENT INJURY, DEATH, OR
PROPERTY DAMAGE!
READ AND UNDERSTAND THE
PROPULSION OPERATOR'S MANUAL
BEFORE ATTEMPTING
TO OPERATE THE VESSEL.

QR Code (Quick Response Code)

Scan with your smart phone
to download your owner's manual.



REGALBOATS.COM/OWNER

The QR code is a trademark for a type of matrix barcode first designed for the automotive industry. A barcode is a machine-readable optical label that contains information about the item to which it is

attached. The Regal QR label when scanned takes you via an "app" to the Regal website where your vessel's owner's manual can be downloaded in a customer friendly format. *Other Regal owner's manuals can be found by scanning this QR Code or by going to: regalboats.com/owners*

In reference to downloading if you have the Garmin plotter installed on your vessel the manual can be read on the plotter screen and may have touch control options to focus in pages as desired.

To use the Garmin feature, you need to copy the owner's manual to an SD card and simply insert the loaded card into the plotter slot, press the tab, and it will appear with the Garmin owner's manual. At this point you can choose the Regal manual, go to the TOC, and use the PDF chapter bookmarks to narrow your page search.

The Garmin plotters offer 2 different size SD cards depending on the plotter used one being a micro SD, and the other a larger sized SDHC card. Your plotter manual identifies the type card slot used.

Owner's Information Packet



An owner's information packet (black satchel) is located on the vessel. Read and become familiar with the materials.

This packet contains valuable information on your propulsion package, standard and optional equipment, systems, care and maintenance along with component warranty. Store the information packet in a clean, dry location on board your vessel.

Vessel Information Sheet

It is recommended that you fill out the information on the following page. It will supply vital statistics on your vessel. Make a copy of the data for safe keeping at home.

ABYC Yacht Plate

In proximity to the helm on Regal boats over 26' in length is a NMMA (National Marine Manufacturer's Association) yacht plate. This plate recognizes that your vessel was built to ABYC design compliance standards in effect on the date the certification was verified. The plate also states that your vessel complies with United States Coast Guard safety system standards in effect on the date of certification.

Note: Overloading, improper loading and weight distribution are well documented causes of accidents. Provide for an extra margin of safety in rough sea conditions.

Hull Identification Number

The United States Coast Guard has established a universal system of numerically recognizing vessels by using a hull identification number or "HIN." This number identifies your Regal yachts' model, hull number, month and year of manufacture. The HIN



is normally found on your boat's transom, on the starboard side, just below the rub rail on the tran-

som vertical surface. The HIN is stamped on a plate and reinforced with a special adhesive. The HIN consists of 12 alpha or numeric characters.

It is recommended that you locate and write down the HIN for future reference. It can be especially useful when ordering parts from your Regal dealer. A second HIN number is found in a hidden location. This second HIN is useful to authorities if the vessel is stolen and/or the original transom HIN is modified or eliminated.

Vessel Float Plan

Formulate the float plan on the following page before departing. Leave it with a responsible person who will notify the United States Coast Guard or local law enforcement authorities if you do not return as planned. If you change your plans be sure to notify this person. Make copies of the float plan and use one each time you go boating. This will help people know where to find you should you not return on schedule. Do not file the float plan with the United States Coast Guard.

Vessel Information Sheet

Owner: _____

Address: _____

City & State: _____

Home Phone: _____ Business Phone: _____

In Case Of Emergency Notify: _____

Address _____

City & State _____

Phone _____

Insurance Agent's Name: _____

Policy#: _____

USCG Phone: _____ Local Police: _____

Marina Phone: _____ Slip (Dock#): _____

Hull Serial #: RGM _____

Key #: _____ Engine: _____

Selling Dealer: _____

Address: _____

City & State: _____

Phone: _____ Fax: _____

Servicing Dealer: _____

Address: _____

City & State: _____

Phone: _____ Fax: _____

Vessel Float Plan

Fill out this form before departure. Leave it with a responsible person who will notify the Coast Guard or police if you don't return as planned. If you change your plans be sure to notify this person. Make copies of the float plan and use one each time you go on a trip. This will help people know where to find you should you not return on schedule. Do not file this plan with the Coast Guard.

Owner: _____
Address: _____
City & State: _____
Telephone#: _____

Person Filing Report: _____
Name _____
Telephone _____

Make Of Craft: _____
Length _____ Boat Name _____
Color _____ Trim _____ Hp _____
Inboard _____ Stern Drive _____
Hull I.D.# _____
Documented Vessel # _____

Other Information _____

Safety Equipment Aboard: _____
Life Jackets _____
First Aid Kit _____
Flares _____
Flash Light _____
VHF Radio _____
Cell Phone __# _____
Computer __Desk Top ____Lap Top____
E-mail address _____
Food _____Water _____

State Registration# _____
Destination: _____
Leave From _____
Time Left _____
Going To _____
Fuel Capacity _____
Est. Day Of Arrival _____

Est. Time Of Arrival _____
If Not Back By ____o'clock Call Authorities

Persons Aboard:

Name	Age	Address	Phone
_____	_____	_____	_____
_____	_____	_____	_____
_____	_____	_____	_____
_____	_____	_____	_____
_____	_____	_____	_____

____ See Other Side For Additional Persons

Vessel Cruise Checklist

- Obtain a current weather update.
- Hoist the boat & periodically inspect the hull bottom and propellers for damage. Marine growth such as barnacles will affect performance and fuel efficiency. Check sacrificial anodes located on the propulsion unit, transom and engine. Replace anode if less than 2/3 remaining.
- Check the electrical system and all safety related equipment. Carry extra fuses. Ensure they are of the proper capacity and type.
- If your boat has been in the water, run the bilge pump until the flow of water stops.
- Check to see that all bilge water has drained and the drain plug is installed before launching If your boat if it has been out of the water.
- Check that all required safety equipment is on board and in good working condition Examples include personal flotation devices (PFD's), horn, bell, hand held fire extinguishers, and visual distress signals.
- Check fuel level. Fuel tanks should be filled to slightly less than capacity. Allow for fuel expansion. Remember the "one third rule".
- Open engine compartment. Inspect for fuel odors and visible leaks in the fuel, oil, coolant, exhaust and power steering systems.
- Check all fuel filters for the presence of water.
- Check fluid levels of engines, drives and generator (if applicable).
- Inspect engine for cracked hoses, worn or loose belts, and loose hardware.

Recommended On Board Equipment

Tools:

Allen Wrenches
Jack Knife
Phillips Screwdriver
Regular & Needle Nose Pliers
Combination Box & End Wrench Set
Screwdriver Set (One With Various Tips)
Side Cutters
Ratchet & Socket Set
Electrical Crimper,Cutter,Stripper Combo
Hammer
VOA Electrical Tester
Water Pump Pliers
Vise Grip Pliers
Floating Flashlight/Lantern
Oil/Fuel Filter Wrench
Tape Rule

Basic Gear & Supplies:

Tow Line
Lubricating Oil, Liquid Wrench
Mooring Lines
Duct & Electricians Tape
Dock Fenders
Coolant (Engine Freshwater Side)
Distress Signals
Engine, Drive, Power Steering Oil
First Aid Kit
Boat Soap (Not Dish Soap)
Boat Hook
Woody Wax
Charts & Plotting Instruments
Back-up
Vinyl Cleaner
Emergency Food & Water
Hydrogen Peroxide (AC Pans)
EPIRB

Spare Parts:

Fuel Filters-Engines & Generator
Poly V- Belt (See Engine Manual)
Coolant For Engine Freshwater System
Extra Light Bulbs
Seawater Filter
Fuses
Propeller Set (See Dealer)
Propeller Hardware
Flashlight Batteries
Engine Spare Parts
Generator Spare Parts
Air Filters-Engine & Generator
Oil Filters-Engine, Generator
Drive Oil Filters

Life Raft
Bailer or Hand Pump
Rust Stain Remover (Star Brite)
Extra Hand Held Fire Extinguishers
Corrosion Block
Personal Floation Devices
Bilge Cleaner
Clean Rags, Diapers
(For Under Engine-Oil Leaks)
Nylon Windbreaker Suit
Sunscreen (SPF 30+)
Shop Vacuum (1 Gal. Cap. Wet-Dry)
Bucket/Pans w/Lids-Draining/Storing
Used Fluids
Squeegee
Mirror (For Inspection & Emergency Signaling)
Binoculars

Owner's Registration & Systems

Please note that your boat requires the proper registration by your authorized Regal dealer. To initiate the vessel warranty your dealer must complete the owner's registration form and systems checklist at the time of delivery. The owner must sign the paperwork to acknowledge that the dealer has reviewed the boat systems and warranty provisions with the owner. The owner should keep the original paperwork that features a temporary warranty registration. A warranty certificate will be sent approximately 6 weeks after receipt of the paperwork at Regal World Headquarters.

Dealer's Responsibility

Your vessel has undergone rigid quality assurance inspections before leaving the factory. In addition, your dealer has been trained to perform final pre-delivery checks and to service your Regal boat.

Your dealer's responsibilities include:

1. An orientation in the operation of your Regal boat including matters relating to the safe operation of the vessel.
2. Completion and mailing of your boat registration warranty form to Regal.
3. Location of vendor warranties, registration materials, owner's manual, operation, installation and maintenance instructions for auxiliary equipment supplied with or installed on your Regal boat.

Owner's Responsibility

You are entitled to all the benefits and services outlined in your Regal warranty. However, you have certain responsibilities to ensure warranty satisfaction. These are:

To read the warranty materials and understand them fully.

To examine the vessel in detail at the time of delivery.

To apply the following: boating rules and regulations, safety equipment, environmental regulations, accident reports and warranty regulations terms and conditions.

To read thoroughly all literature supplied with your boat including this owner's manual and to follow the recommendations in the literature.

To provide proper maintenance and periodic servicing of your boat and equipment as set forth in the various manuals supplied.

Customer Service

Take the time to write down your Regal dealer's phone number and E-mail address for future reference. Along with your Regal dealer information is a listing below of other phone numbers and web addresses which may prove useful.

Regal Dealer:

Phone: _____

E-mail: _____

Regal Marine Customer Service:

1-800-US REGAL (1-800-877-3425)

regal@regalboats.com

customer.service@regalboats.com

REGAL MARINE INDUSTRIES, INC. LIMITED WARRANTY

Welcome to the Worldwide Family of Regal Owners! We are very pleased that you have chosen a Regal Powerboat!

This document is your Limited Warranty Registration Certificate and Statement of Limited Warranty. Please check the registration information section for accuracy. If this information is not correct or if you change your address at some future date, please notify us at the following address: Regal Marine Industries, Inc. Attention: Warranty Registrations, 2300 Jetport Drive, Orlando, Florida 32809; or e-mail customerservice@regalboats.com.

Please read the warranty carefully. It contains important information on Regal's claims procedures and your rights and obligations under this warranty.

WHAT IS COVERED: This Limited Warranty applies only to Regal boats beginning with model year 2017.

LIFETIME LIMITED STRUCTURAL DECK & HULL WARRANTY: Regal Marine Industries, Inc. warrants to the original retail purchaser of this boat if purchased from an authorized Regal dealer that the selling dealer or Regal will repair or replace the factory installed fiberglass if it is found to be structurally defective in material or workmanship for as long as the original retail purchaser owns the boat. For purposes of this Limited Warranty, the hull is defined as the single fiberglass casting which rests on the water. This Limited Warranty is subject to all limitations and conditions explained below.

FIVE-YEAR TRANSFERABLE LIMITED STRUCTURAL HULL WARRANTY: In addition to the Lifetime Limited Structural Hull Warranty, Regal offers a Transferable Five-Year Limited Structural Hull Warranty. Under the Five-Year Transferable Limited Structural Hull Warranty, Regal will repair or replace the fiberglass hull or deck if it is found to be structurally defective in material or workmanship within the first (5) years after the date of delivery to the original retail purchaser. Any remaining term of this Five-Year Limited Hull Warranty may be transferred to a second owner if within 60 days of purchase, the new owner registers the transfer with Regal and pays the established Limited Warranty transfer fee. Contact Regal Customer Service at the above address for details.

FIVE-YEAR LIMITED HULL BLISTER WARRANTY: Regal warrants that the Regal selling dealer or Regal will repair any underwater gelcoated surfaces of the hull against laminate blisters which occur as a result of defects in material or workmanship within (5) years of the date of delivery, provided that the original factory gelcoat surface has not been altered. Alternation would include but is not limited to damage repair; excessive sanding, scraping, sandblasting; or from improper surface preparation for application of a marine barrier coating or bottom paint, any of which shall void this Five-Year Limited Hull Blister Warranty. Proper preparation must be applied to the hull bottom if the boat is to be moored for periods in excess of (60) days. Regal Marine shall repair or cause to be repaired any covered laminate blisters based on the following prorated schedule. Less than three (3) years from delivery date - 100%, Three (3) to (4) years from delivery date - 50%, Four (4) to (5) years from delivery date - 25%.

Reimbursement shall be limited to one repair, not to exceed (\$100.00) dollars per foot of boat length prior to prorating. Regal's prior authorization for the method and cost of repair, must be obtained before repairs are commenced. All costs to transport the boat for repairs are the responsibility of the owner.

LIMITED GENERAL WARRANTY: In addition to above hull warranties, Regal warrants to the original purchaser of this boat if purchased from an authorized Regal dealer, that the authorized Regal dealer or Regal will repair or replace any parts found to be defective in materials or workmanship for a period of one (1) year from the date of delivery, subject to all exceptions, limitations and conditions contained herein.

LIMITED EXTERIOR FINISH WARRANTY: Regal warrants that the authorized Regal selling dealer or Regal will repair cosmetic defects in the exterior gelcoated finish including cracks, air voids or crazing for one year from the date of delivery, subject to all limitations and conditions contained herein. All warranty work is to be performed at a Regal dealership or other location authorized by a Regal Customer Service Manager after it is established to Regal's satisfaction that there is a defect in material or workmanship.

CUSTOMER OBLIGATIONS: The following are conditions precedent to the availability of any benefits under these limited warranties:

(a) The purchaser, who is not Regal's sales agent and is otherwise not in any general or sales agency relationship with Regal, must sign and the authorized Regal selling dealer, must submit to Regal the "NEW BOAT DELIVERY and ACCEPTANCE CHECKLIST" within fifteen (15) days of the date of delivery and such information must be on file at Regal.

(b) The purchaser must first notify the authorized Regal selling dealer from whom the boat was purchased of any claim under this Limited Warranty within the applicable Limited Warranty period and within a reasonable period of time (not to exceed thirty (30) days) after the defect is or should have been discovered.

(c) Regal will not be responsible to repair any condition or replace any part, (1) if the use of the boat is continued after the defect is or should have been discovered; and (2) if such continued use causes other or additional damage to the boat or component parts of the boat.

(d) Based on the authorized Regal selling dealer's knowledge of Regal's Limited Warranty policy and/or consultations with Regal, the dealer will accept the claim and arrange for appropriate repairs to be performed, or deny the claim if it is not within the Limited Warranty policy.

(e) The authorized Regal selling dealer will contact the Regal boat owner regarding instructions for delivery of boat or part for covered warranty repair if it is covered by the Limited Warranty.

ALL COSTS TO OR FROM THE BOAT AND/OR TRANSPORT OF THE BOAT FOR REPAIRS ARE THE RESPONSIBILITY OF THE OWNER.

(f) If the Regal boat owner believes a claim has been denied in error or the authorized Regal selling dealer has performed the warranty work in an unsatisfactory manner, the owner must notify Regal's Customer Service Department in writing at the address listed for further consideration. Regal will then review the claim and take appropriate follow-up action.

(g) Before bringing any action, claim, lawsuit, or otherwise seeking relief against Regal based on any alleged breach of any of the Limited Warranties, terms or conditions herein, the Regal Boat owner must contact Regal's Customer Service Department Directly allow Regal, beyond those efforts made by its authorized Regal dealer, notice an opportunity to cure any alleged breach of any of the terms of any of the Limited Warranties.

WARRANTY EXCEPTIONS: THIS LIMITED WARRANTY does not cover, the following are not warranted are excluded from the terms of the Regal Limited Warranty and the following terms apply to any Regal Limited Warranty.

- (a) Engines, drives, controls, propellers, batteries, metal plating or finishes, windshield breakage, leakage, fading and deterioration of paints, canvas, vinyl, upholstery and fabrics;
- (b) Gelcoat surfaces including, but not limited to discoloration or blistering except as noted above;
- (c) Accessories and items which were not part of the boat when shipped from the Regal factory, or which carry their own individual warranty and/or any damage caused by such accessories or items;
- (d) Damage caused by one or more of the following: misuse, accident, corrosion, galvanic corrosion, negligence, lack of proper maintenance, or improper trailering;
- (e) Any boat used for racing, or used for rental or commercial purposes;
- (f) Any boat operated contrary to any instructions furnished by Regal, including instructions and guidance provided in the Regal Owner's Manual, or operated in violation of any federal, state, Coast Guard or other governmental agency laws, rules, or regulations;
- (g) The limited warranty is void if alterations have been made to the boat;
- (h) Transportation of boat or parts to and/or from the REGAL factory or service location;
- (i) Travel time or haul outs, loss of time or inconvenience;
- (j) Any published or announced catalog performance characteristics of speed, fuel and oil consumption, and static or dynamic transportation in the water;
- (k) Any boat that has been re-powered beyond Regal's power recommendations;
- (l) Boats damaged by accident and boats damaged while being loaded onto, transported upon or unloaded from trailers, cradles, or other devices used to place boats in water, remove boats from water or store or transport boats on or over land;
- (m) Any item repaired, replaced or modified under the terms of this warranty does not in any way prolong, extend or change any terms set forth in this limited warranty;
- (n) Water damage to, dry rot to, condensation to, or absorption by interior surfaces, wood structures or polyurethane foam; interior wood including, but not limited to mold, bleeding and/or discoloration as a result of condensation or moisture or water continually contacting the plywood causing staining to upholstery, carpet or other interior surfaces;
- (o) Costs or charges derived from inconvenience or loss of use, commercial or monetary loss due to time loss, and any other special, incidental or consequential damage of any kind or nature whatsoever;
- (p) Regal reserves the right to improve the design or manufacture process of Regal boats without obligation to modify previously produced product;

NO WAIVER OF THESE TERMS: The terms, conditions, limitations and disclaimers contained herein cannot be waived except by the Customer Service Manager of Regal. Any such waiver must be in writing. Neither the dealer, nor the customer, nor any service, sales and/or warranty representative of Regal is authorized to waive and/or modify these conditions, limitations and/or disclaimers.

EXCEPT AS SET FORTH HEREIN OR ON ANY OTHER WRITTEN EXPRESS LIMITED WARRANTIES BY REGAL, THERE ARE NO OTHER WARRANTIES EITHER EXPRESSED OR IMPLIED PROVIDED BY REGAL ON THIS BOAT. ALL OTHER WARRANTIES, EXPRESS OR IMPLIED, INCLUDING IMPLIED WARRANTIES OF FITNESS AND MERCHANTABILITY, ARE EXPRESSLY EXCLUDED. REGAL FURTHER DISCLAIMS ANY LIABILITY FOR ECONOMIC LOSS ARISING FROM CLAIMS OF PRODUCT FAILURE, NEGLIGENCE, DEFECTIVE DESIGN, MANUFACTURING DEFECT, FAILURE TO WARN AND/OR INSTRUCT, LACK OF SEAWORTHINESS, AND ANY OTHER THEORY OF LIABILITY NOT EXPRESSLY COVERED UNDER THE TERMS OF THIS LIMITED WARRANTY.

AS SET FORTH ABOVE, REGAL MAKES NO IMPLIED WARRANTY OF MERCHANTABILITY AND EXPRESSLY EXCLUDES ANY SUCH WARRANTY. TO THE EXTENT SUCH EXCLUSION IS NOT ALLOWED BY LAW OR AN IMPLIED WARRANTY OF MERCHANTABILITY IS ALLOWED BY LAW: (1) ANY IMPLIED WARRANTY OF MERCHANTABILITY THAT IS, AS A MATTER OF LAW, NOT PERMITTED TO BE EXCLUDED AS SET FORTH ABOVE, IS LIMITED TO ONE

YEAR FROM THE DATE OF DELIVERY TO THE FIRST RETAIL OWNER; (2) NEITHER REGAL NOR ANY SELLING DEALER SHALL HAVE ANY RESPONSIBILITY FOR LOSS OR USE OF THE BOAT, LOSS OF TIME, INCONVENIENCE, COMMERCIAL LOSS, INCIDENTAL OR CONSEQUENTIAL DAMAGES. SOME STATES MAY NOT ALLOW EXCLUSIONS OF IMPLIED WARRANTIES OR LIMITATIONS ON HOW LONG ANY IMPLIED WARRANTY LASTS, SO THE ABOVE LIMITATION MAY NOT BE APPLICABLE. SOME STATES MAY NOT ALLOW THE EXCLUSION OR LIMITATION OF INCIDENTAL OR CONSEQUENTIAL DAMAGES, SO THE ABOVE LIMITATIONS OR EXCLUSIONS MAY NOT BE APPLICABLE IN THOSE STATES. THIS WARRANTY GIVES THE OWNER SPECIFIC LEGAL RIGHTS, AND THE OWNER MAY ALSO HAVE OTHER RIGHTS WHICH VARY FROM STATE TO STATE.

THE TERMS AND CONDITIONS CONTAINED HEREIN, AS WELL AS THOSE OF ANY DOCUMENTS PREPARED IN CONJUNCTION WITH THE SALE OF THIS VESSEL MAY NOT BE MODIFIED, ALTERED OR WAIVED BY ANY ACTION, INACTION OR REPRESENTATIONS, WHETHER ORAL OR IN WRITING, EXCEPT UPON THE EXPRESSED, WRITTEN AUTHORITY OF A MANAGEMENT LEVEL EMPLOYEE OF REGAL. Some states do not allow limitations on how long an implied warranty lasts, so the above limitation may not apply to you. Regal's obligation with respect to this warranty is limited to making repairs to or replacing the defective parts and no claim for breach of warranty shall be cause for cancellation or rescission of the contract or sale for any boat manufacturer by REGAL MARINE INDUSTRIES, INC.

Regal will discharge its obligations under this warranty as rapidly as possible, but cannot guarantee any specific completion date due to the different nature of claims which may be made and services which may be required. Regal reserves the right to change or improve the design of its boats without obligation to modify any boat previously manufactured. This limited warranty gives you specific legal rights, and you may also have other rights which may vary from state to state. Regal shall in no way be responsible for any repairs not PRE-AUTHORIZED by a Regal Customer Service Manager or repairs performed by a repair shop not PRE-AUTHORIZED by a Regal Customer Service Manager.

ARBITRATION OF DISPUTES AND WAIVER OF JURY TRIAL

EXCEPT AS SPECIFICALLY EXCLUDED IN THIS LIMITED WARRANTY, PURCHASER, REGAL AND AUTHORIZED REGAL DEALER AGREE TO SUBMIT ANY AND ALL CONTROVERSIES, CLAIMS OR DISPUTES ARISING OUT OF OR RELATING TO THE BOAT AND THIS LIMITED WARRANTY AND ALL OTHER AGREEMENTS EXECUTED BY PURCHASER RELATED TO THE BOAT TO BINDING ARBITRATION. IT IS THE EXPRESS INTENT OF PURCHASER, REGAL AND DEALER THAT THIS ARBITRATION PROVISION APPLIES TO ALL DISPUTES, INCLUDING CONTRACT DISPUTES, TORT CLAIMS, FRAUD CLAIMS AND FRAUD-IN-THE INDUCEMENT CLAIMS, STATUTORY CLAIMS AND REGULATORY CLAIMS RELATING IN ANY MANNER TO THE BOAT AND THIS LIMITED WARRANTY.

IF ANY CONTROVERSY OR CLAIM DESCRIBED IN THIS ARBITRATION PROVISION IS DETERMINED FOR ANY REASON TO BE INELIGIBLE FOR ARBITRATION, AND FOR ANY CONTROVERSIES, CLAIMS, OR DISPUTES SPECIFICALLY EXEMPTED FROM ARBITRATION, THEN THOSE CONTROVERSIES, CLAIMS, OR DISPUTES SHALL INSTEAD BE DECIDED BY A JUDGE OF A COURT OF COMPETENT JURISDICTION, IN ORANGE COUNTY, FLORIDA, WITHOUT A JURY. PURCHASER, REGAL AND DEALER KNOWINGLY AND VOLUNTARILY WAIVE THE RIGHT TO A TRIAL BY JURY FOR ALL SUCH CONTROVERSIES, CLAIMS AND DISPUTES. PURCHASER, REGAL, AND DEALER UNDERSTAND THAT THERE SHALL BE NO JURY TRIAL, WHETHER THE CONTROVERSY OR CLAIM IS DECIDED BY ARBITRATION OR BY TRIAL BEFORE A JUDGE. NOTWITHSTANDING THE PROVISIONS OF THIS ARBITRATION AGREEMENT, WITH REGARD TO CONTROVERSIES AND/OR ENTITLEMENT TO POSSESSION OF EITHER THE BOAT OR ANY TRADE-IN, ANY PARTY HERETO MAY RESORT TO A JUDICIAL DETERMINATION (BY A JUDGE AND NOT A JURY). OF SUCH CONTROVERSIES, DISPUTES OR CLAIMS WITHOUT WAIVING ANY RIGHT TO DEMAND ARBITRATION WITH RESPECT TO ALL OTHER CONTROVERSIES, DISPUTES OR CLAIMS BETWEEN THE PARTIES A MORE SPECIFICALLY SET FORTH IN THIS ARBITRATION PROVISION.

ALL ARBITRATIONS SHALL PROCEED THROUGH THE AMERICAN ARBITRATION ASSOCIATION AND BE SUBJECT TO ITS COMMERCIAL ARBITRATION RULES, EXCEPT AS SET FORTH HEREIN. THE ARBITRATORS SHALL HAVE THE AUTHORITY TO AWARD ANY FORM OF RELIEF THAT COULD BE PROPERLY AWARDED IN A CIVIL ACTION IN THE STATE OF FLORIDA FOR THE TYPE OF CLAIMS PRESENTED, SUBJECT HOWEVER, TO ALL LIMITATIONS, PREDICATES, AND CONDITIONS COVERING SUCH REMEDIES OR RELIEF UNDER FLORIDA LAW.

THE PURCHASER, REGAL OR DEALER MAY DEMAND ARBITRATION OF A CLAIM BY FILING A WRITTEN DEMAND FOR ARBITRATION, ALONG WITH A STATEMENT OF THE MATTER IN CONTROVERSY WITH THE AMERICAN ARBITRATION ASSOCIATION, AND SIMULTANEOUSLY SERVING A COPY UPON THE OTHER PARTY. PURCHASER, REGAL AND DEALER AGREE THAT THE ARBITRATION PROCEEDING SHALL BE CONDUCTED IN ORANGE COUNTY, FLORIDA UNLESS OTHERWISE AGREED BY THE PARTIES. EACH PARTY AGREES TO BEAR THEIR OWN ATTORNEY FEES AND COSTS. THE FILING FEES AND ALL OTHER THIRD-PARTY COSTS FOR THE ARBITRATION, INCLUDING THE ARBITRATOR'S FEE SHALL BE PAID BY THE FILING PARTY INITIATING THE ARBITRATION. THE PREVAILING PARTY SHALL BE ENTITLED TO REIMBURSEMENT OF THEIR REASONABLE ATTORNEY FEES AND REASONABLE EXPENSES FROM THE NON-PREVAILING PARTY.

REGISTRATION INFORMATION:

Chapter 2

Safety On Board



Safety Overview

Safety awareness can not be over emphasized. Safety on board needs to be the skippers number one priority. In this manual you will find many safety precautions and symbols to identify safety related items. Heed all safety precaution information. Remember, the skipper is responsible for the safety of his passengers and crew

Safety Precaution Label Definition:

Safety precautions are stated as caution, warning and danger signal words. They are highlighted in this manual by font design and symbol usage. Also, a notice heading is included which provides operation and maintenance information but is not hazard-related. An information label provides tips on a variety of topics. Become familiar with and understand all safety labels!

NOTICE

General or specific information which is important to correct operation or maintenance, but is not hazard related.



CAUTION

Indicates a potentially hazardous situation or unsafe practice that, if not avoided, may result in injury, property or product damage.



WARNING

Potentially hazardous situation that, if not avoided, could result in death or serious injury.



DANGER

Immediate hazardous situation that if not avoided, will result in death or serious injury.

Precautionary Labels

Read and understand all safety labels affixed to your Regal boat or found in this manual and the vendor literature. Many of the safety labels are posted close to the helm, aft cockpit, cabin and swim platform. The location of the labels may vary. Review the helm safety labels with passengers before disembarking. Use common sense to analyze the result of an action on board your vessel. Always think safety first!

NOTICE

DO NOT REMOVE OR COVER ANY PRECAUTIONARY LABELS. KEEP HARSH CHEMICALS AWAY FROM LABELS. IF A LABEL BECOMES ILLEGIBLE, CONTACT YOUR REGAL DEALER FOR ORDERING REPLACEMENTS.

General Boating Safety

We understand that you are eager to go boating. However, we strongly suggest that you thoroughly familiarize yourself and friends or members of your family with safe boating practices before setting out. Remember, that along with the freedom and exhilaration of boating comes the responsibility that you have for the safety of your passengers and other boaters who share the water with you.

Boating regulations vary from state to state. Check with your local and state authorities for the regulations pertaining to your area.

Check with local FM weather stations, U. S. Coast Guard, or on-line for the latest weather conditions.

Remember getting caught in severe weather is hazardous. Check weather conditions periodically while you are boating. If you are forced to operate your boat in a storm condition, take common sense precautions; wear PFD's, store gear, reduce speed and if possible head for safe refuge.

It is best to avoid operating your boat in foggy weather. When fog sets in, take bearings, log courses and speeds. You are required to emit a five second blast from your horn or whistle once every minute. Also, have your passengers wear PFD's and observe for oncoming vessels.

Operation in shallow water presents a number of hazards including sand bars and water levels influenced by tides. If the vessel strikes an underwater hazard, check for boat and engine damage. If the engine vibrates excessively after striking an underwater obstruction, it may indicate a damaged propeller. If you run aground, seek help by radio or flares.

Make sure your boat and equipment are in top condition. Do this by frequently inspecting the hull, engine and propulsion components.

You must provide a Coast Guard approved personal flotation device (PFD) for every person on board. These PFD's should be in good condition and easily accessible.

Insist that non-swimmers and children on board wear a PFD at all times. If you encounter rough weather conditions, make sure everyone on board is wearing a PFD, including yourself. Instruct your

passengers in how to put on their PFDs and be sure they know their storage location on the boat. Remember, in an emergency, a PFD that cannot be quickly located and worn is useless.

Never allow anyone to sit anywhere on the boat not specifically designed as seating. **While underway, ALWAYS insist passengers occupy a recognized seat position.**



Never drink and drive! As captain, you are responsible for the safety of your passengers. Alcohol and boating can be a dangerous combination. **DO NOT** mix them. Alcohol impairs the boat operators ability to make conscious decisions and react to emergency situations quickly.

Never overload your boat! An overloaded boat, or one with uneven weight distribution can be difficult to steer. **Never let people stand in bow area while underway as vision will be obstructed!!!**

 **CAUTION**

READ AND UNDERSTAND THE SEATING ARRANGEMENT DRAWING IN THE TECHNICAL CHAPTER. THIS DRAWING DISPLAYS THE DESIGNATED SEATING ARRANGEMENT FOR A BALANCED LOAD AND VESSEL MAXIMUM PERSONS CAPACITY.

Use maximum caution when fueling. Never allow any smoke or flame nearby while you are fueling. **ALWAYS** check for fuel leaks and fumes when

fueling is completed. Be certain there is enough fuel aboard for your cruising needs. Include any reserve that might be needed should you change your plans due to weather or an emergency. Practice the “one-third rule: Use one-third of your fuel going out, one-third to return and retain one-third as a reserve.

Always check the weather before departure. Be particularly cautious of forecasted electrical storms and high winds.

Always have up-to-date charts aboard as a backup to your plotter and auto pilot option. Charts can be obtained at your closet marina, on-line store or by contacting one of three federal government agencies.

Always file a float plan. Leave details of your trip with someone responsible who will be remaining on shore. Include expected return, plus name and phone number of a contact person in case of emergency.

Use care, courtesy and common sense when launching, docking or operating your boat.

Learn and obey the “Rules of the Road”. A weather resistant placard copy of the “Rules of the Road” is included in the on board Regal information packet. Additional information can be obtained from the U.S. Coast Guard Auxiliary or your local Power Squadron organization.

In case of emergency know the international distress signals for your VHF radio. The spoken word “MAYDAY” is the international signal of distress and is for emergency use only. Under no circumstances should this word be used, unless there is danger at hand.

General Boating Safety- Continued

Operation in shallow water presents a number of hazards including sand bars and water levels influenced by tides. If the vessel strikes an underwater hazard, check for boat and engine damage. If the engine vibrates excessively after striking an underwater obstruction, it may indicate a damaged propeller. If you run aground, seek help by radio or flares.

Make sure your boat and equipment are in top condition. Do this by frequently inspecting the hull, engine and propulsion components.

You must provide a Coast Guard approved personal flotation device (PFD) for every person on board. These PFD's should be in good condition and easily accessible.

Insist that non-swimmers and children on board wear a PFD at all times. If you encounter rough weather conditions, make sure everyone on board is wearing a PFD, including yourself. Instruct your passengers in how to put on their PFDs and be sure they know their storage location on the boat. Remember, in an emergency, a PFD that cannot be quickly located and worn is useless.

Never allow anyone to sit anywhere on the boat not specifically designed as seating. While underway, **ALWAYS** insist passengers sit in a seat and set an example by doing this yourself.

Never drink and drive! As captain, you are responsible for the safety of your passengers. Alcohol and boating can be a dangerous combination. **DO NOT** mix them. Alcohol impairs the boat operators ability to make conscious decisions and react to emergency situations quickly.

Never overload your boat! An overloaded boat, or one with uneven weight distribution can be difficult to steer.

Insist that passengers sit in seats while the vessel is making headway!! See technical section for seating positions while underway. No one to be standing in the bow area nor on the front deck while underway as visibility will be obstructed and safety compromised!!!

Posted speed limits, swimming areas, "no wake" zones and other restrictions should be red-flagged. They are so noted for a reason. Sensible boat use, plus courtesy, equals enjoyable and safe boating.

It is your responsibility to stay abreast of all federal, state and local rules, as some laws or regulations may change or be different from state to state. Contact your local boating agencies for updated information.

We can not stress safety enough! Remember, there are no brakes on your boat, and the water current and wind velocity both affect your ability to respond.

Required Safety Equipment

Personal Flotation Devices:

All personal flotation devices (PFD's) must be Coast Guard approved, in good working condition, and must be the correct size for the wearer. All PFD's must be readily accessible. This means being able to wear them in a reasonable amount of time in case of an emergency (fire, boat sinking, etc.). They should not be stored or locked in closed areas. Also, make sure that all coverings are removed such as plastic from any PFD's. Throw-able devices such as a ring buoy need to be available for immediate deployment. A PFD should be worn at all times when your boat is operating on the water. A PFD may save your life, but it must be worn to do so.

As a minimum U. S. Coast Guard requirement all recreational boats must carry one type I, II, III, or V PFD (wearable) for each person aboard. See the explanation following for each type. For type V to be counted they must be used according to the label instructions. In addition, all boats over 16' must carry one Type IV (throw-able) PFD.

Some states require that PFD's be worn by children of specific ages at all times. Check with local and state boating agencies for particular requirements in your state before taking children on the water. Child life jackets are classified by the child's weight and should like all life jackets be sized before being purchased.

Remember PFD's will not necessarily keep you from drowning, even though they are designed to keep a person from sinking. When purchasing PFD's make sure it safely fits the person wearing it. It is a good idea to test PFD's in a life guarded

shallow pool before venturing on the water.

Refer to the USCG minimum equipment requirements at the end of this chapter. It is meant to be a guide only. Contact state and local agencies for additional equipment requirements. Remember as the captain of your vessel you are responsible for its safe operation.



Type I:

Also known as an off-shore jacket, it provides the most buoyancy. It is a PFD for all waters and is especially useful in rough waters where rescue may encompass additional time. It is designed to turn most unconscious users in the water to a true face-up position. Type I PFD is available in adult & child sizes Buoyancy minimum poundages are 15.5 adult, 11 medium child, and 7 for small child and infants.

Type II:

Also known as near-shore buoyant vest, it is recommended for calm, inland water where rescue time will be minimal. It will turn some unconscious people face-up in the water but not as numerous as Type I. They are available in adult, medium child, along with infant and small child sizes.

Type III:

Known as a flotation aid it is good for calm, inland water or where there is a chance for quick rescue. It is designed so wearers can place themselves in a face-up position in the water. The wearer may have to tilt their head back to avoid face-down positions. Type III offer the same buoyancy minimum poundages as the Type II. They are generally the most comfortable for continuous wear. Float coats, fishing vests, and vests featuring designs for various sport activities are examples of Type III.

Type IV:

Intended for calm, inland water with heavy vessel traffic, where help is constantly present. It is designed to be thrown into the water for someone to grab on to and held until rescued. It is not designed to be worn. Type IV includes ring buoys, buoyant cushions, and horseshoe buoys.

Type V:

Also known as a special use device this is the least bulky of all PFD's. It contains a small amount of inherent buoyancy, and an inflatable chamber. It is rated even to a Type I, II, or III PFD (as noted on the jacket label) when inflated. Some Type V devices provide significant hypothermia protection. Varieties include deck suits, work vests, board sailing vests and Hybrid PFD's. Remember that this Type V type PFD may be carried instead of another PFD only if used according to the approval condition on the label.

Note: A water skier or wake boarder is considered on board the vessel and a PFD is required for the purposes of compliance with the PFD carriage requirements. It is advisable and recommended for a skier or wake boarder to wear a PFD designed to withstand the impact of hitting the water at a high speed. "Impact Class" marking on the label refers to PDF strength, not personal protection. Some state laws require a skier or wake boarder to wear a PFD.

PFD's For Pets:

If you are a skipper who needs to have his pet dog or cat on board or dock side then a PFD is recommended. The PFD will aid you in finding the pet if it should fall overboard. The device must fit the pet properly. Also, it may take a bit of training before the pet is comfortable wearing the PFD. Normally, dogs are easier to train wearing a life vest than a cat. Marine type retail stores will fit a pet to a PFD by body weight.

Maintaining Your PFD's

A PFD is only useful if it is well maintained. Always be aware of PFD age since it has a life expectancy like any other piece of equipment.

- ✓ Check periodically for broken zippers, frayed webbing, water soaked kapok bags, missing straps, and sewing that has become undone.
- ✓ Clean each PFD with mild soap and water only. Again, let dry sufficiently before storing.
- ✓ Keep PFD's out of grease and oil since they can deteriorate the jacket inner and outer materials.
- ✓ Check any kapok-bagged jackets by squeezing. If you hear air escaping the bag is defective and the PFD should be thrown away.
- ✓ Grab the cover with the fingers. If the cover material rips, the PFD is rotted and should be thrown away.
- ✓ If the kapok bag is hard the PFD should be discarded.

Fire Extinguishers

General Information:

Fire extinguishers are classified by a letter and numeric symbol. The letter references the type of fire the unit is designed to extinguish.

For example, type B extinguishers commonly used on boats are designed to put out flammable liquids such as grease, oil and gasoline.

The number indicates the general size of the extinguisher (minimum extinguishing agent weight).

Coast Guard Approved extinguishers are identified by the following marking on the label:

"Marine Type USCG Approved, Size..., Type..., 162.028/.../...", etc.

MINIMUM PORTABLE FIRE EXTINGUISHERS REQUIRED		
VESSEL LENGTH	NO FIXED SYSTEM	WITH FIXED SYSTEM
LESS THAN 26'	1 B-I	0
26' TO LESS THAN 40'	2 B-I or 1 B-II	1 B-I
40' TO 65'	3 B-I or 1 B-I & 1 B-II	2 B-I or 1 B-II

FIRE EXTINGUISHER CONTENTS				
CLASS	FOAM IN GALS.	CO2 IN LBS.	DRY CHEM IN LBS.	HALON IN LBS.
B-I	1.25	4	2	2.5
B-II	2.5	15	10	10

U. S. Coast Guard approved fire extinguishers are required on all Regal boats. Besides the minimum Coast Guard requirements always check state and local agencies for additional requirements and equipment.

Coast Guard approved extinguishers are hand-portable, either B-I or B-II classification. U. S. Coast Guard approved hand-portable and semi-portable extinguishers contain a metal plate that shows the manufacturers name and extinguisher type, capacity and operating instructions. They have a special marine type mounting bracket which keeps the extinguisher solidly mounted until needed. The extinguisher needs to be mounted in a readily accessible location but one that will not be bumped by people while underway. All approved extinguishers shall have an indication gauge.

U.S.C.G Approved Fire Extinguisher Types & Features:



The dry chemical agent is widely used because of its convenience and low cost. The extinguisher canister is filled with a white dry chemical powder along with a pressurized gas. It is a

good idea to shake this type periodically because they tend to “pack” on the canister bottom.



The foam type uses a chemical foaming agent plus water and is best when used for fires involving flammable liquids- solvents, gasoline, oil, grease and various paints. It will work on fires involving

rubber, plastics, cloth, wood, and paper. It leaves a messy residue. Do not use this extinguisher for electric fires.



The carbon dioxide unit uses CO₂ gas under high pressure, with a funnel discharge hose usually swivel mounted. This extinguisher leaves no residue

and does not cause interior engine harm. To ensure workability, weigh the unit annually. A 10% maximum weight variance is allowed.

Another type of liquefied gas used today is FE-241. This gas is colorless and odorless, heavier than air and sinks to the lower bilge to extinguish fires. Since the year 2000 ingredients have changed to a more environmental friendly formula (Chlorotetrafluoroethane or FE-241). FE-241 is used in portable-hand units along with making up the majority of boat automatic fire extinguishing systems. The canister needs to be weighed once a year. These clean agent units feature a dash mount indicator. Refer to the information regarding fire prevention in this manual.

Pyrotechnic Devices:

Pyrotechnic visual distress signals must be Coast Guard approved, be ready for service and must be readily accessible. They all display a marking which is the service life, which must not have expired. A minimum of 3 devices are required for the day and 3 devices for night.

Some devices meet both day and night requirements. Pyrotechnic devices should be stored in a cool, dry location. Most of these devices can be purchased in an highly visible (orange) watertight container. Types of Coast Guard approved pyrotechnic distress signals and associated devices are:

- Pyrotechnic red flares, hand-held or aerial type.
- Pyrotechnic orange smoke, hand-held or floating type.
- Launchers for parachute flares or aerial red meteors.

All in all, each distress signal has certain advantages and disadvantages.

There is no distress signal that is best under all situations. Pyrotechnics are recognized worldwide as superior distress signals. A downfall is they emit a very hot flame that can cause burns and or ignite flammable materials. Pistol launched and hand-held parachute flares operate consistent with firearms and therefore must be carefully handled. Check with local and state regulations since some of these device are considered firearms and are prohibited.

It is best to carry red aerial flares which are visible from a greater distance. Also, the red parachute flares burn for longer periods and therefore are more likely to be seen by another vessel.

Non-Pyrotechnic Devices:

Non-pyrotechnic devices must all be in serviceable condition, readily accessible, and must be certified by the manufacturer to comply with U. S .C. G standards. They include:

- Orange distress flag.
- Electric distress light.

The distress flag is for day use only. It must be 3 x 3 or larger with a black square and ball on an orange background. It can be spotted when attached to a boat hook, long fishing rod, or paddle with the person waving the flag back and forth overhead.

The electric distress light is for night use only flashing the international SOS distress signal (... _ _ _ ...).

Under Inland Navigation Rules, a high intensity white light that flashes at regular intervals from 50-70 times per minute is considered a distress signal.

Remember that regulations prohibit the display of visual distress signals on the water under any circumstances except when assistance is required to prevent immediate or potential danger to passengers on a vessel.

International Distress Signals

A distress signal, also known as a distress call, is an internationally recognized means for obtaining help. Distress signals are communicated by transmitting radio signals, displaying a visually observable item or illumination, or making a sound audible from a distance.

Use of Mayday

A Mayday message consists of the word “mayday” spoken 3 times in succession, which is the distress signal, followed by the distress message, which should include:

1. Name of the vessel or ship in distress.
2. Her position (actual, last known or estimated expressed in lat/long. or distance/bearing from a specific location).
3. Nature of the vessel distress condition or situation (e.g. on fire, sinking, aground, taking on water, adrift in hazardous waters).
4. Number of persons at risk or to be rescued, grave injuries.
5. Type of assistance needed or being sought.
6. Any other details to facilitate resolution of the emergency such as actions being taken (e.g. abandoning ship, pumping flood water) est. time afloat.

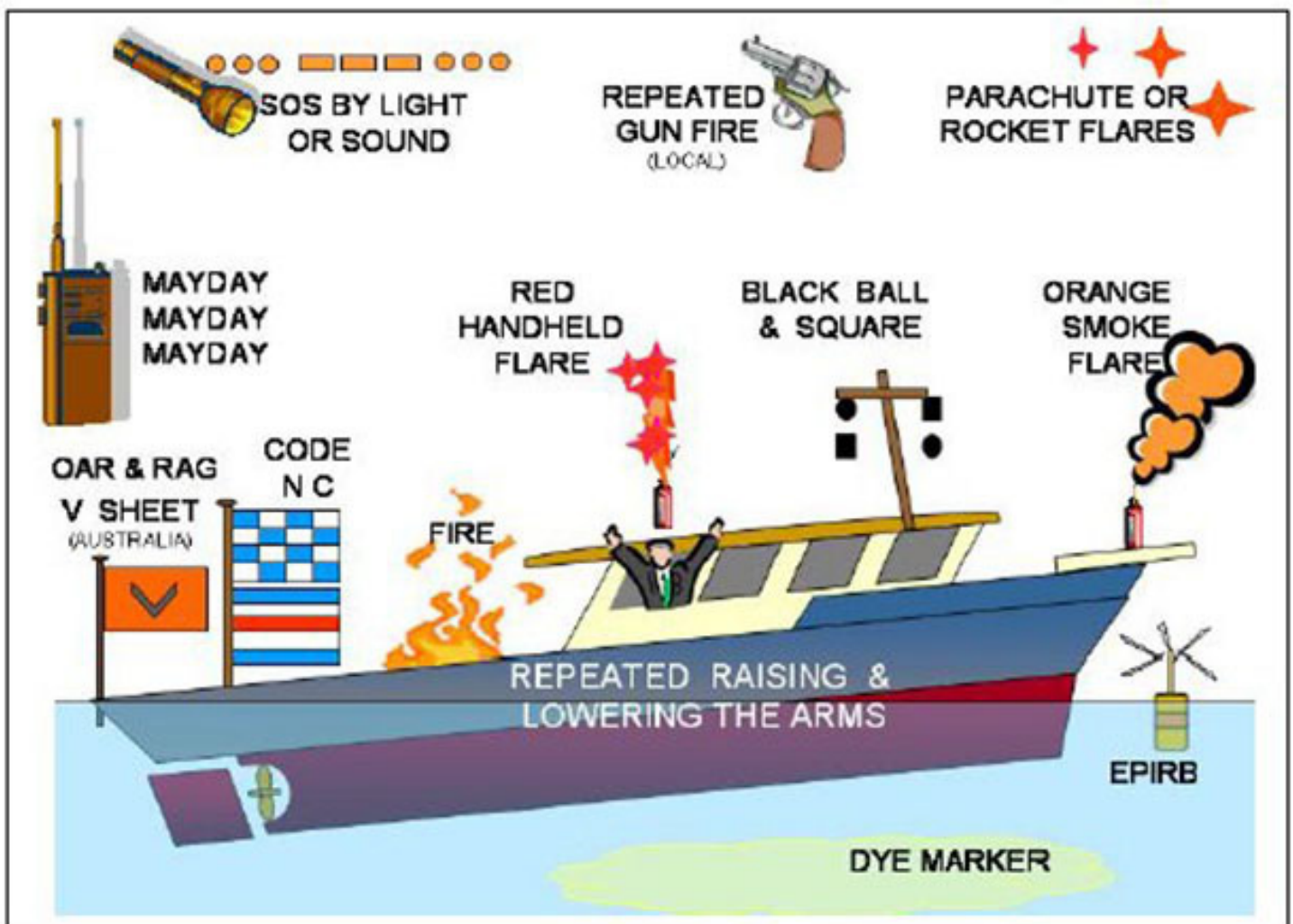

Sound Producing Devices

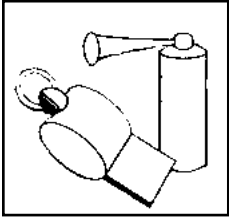

According to both Inland and International Rules, all boats must carry a way of producing an efficient sound signal. If your vessel is 12 meters (39' 4") or longer, a power whistle or power horn and bell must be carried. Bell mouth must be at least 7 7/8" diameter. The sound signal made in all cases must be capable of a four or six second blast audible for one half mile. See the section discussing bridge and whistle signals for more information.

Radio Communications:

VHF radios are used for distress and ship to shore and ship to ship communications today. Learn the specialized messages such as Mayday, Mayday, Mayday. It is only used when life or vessel is in imminent danger.



Many of the more recent VHF's feature DSC capability which offers the ability to place and receive digital calls directly with vessels and shore stations including USA and Canadian Coast Guards. Channel 70 is reserved exclusively for DSC calls. Refer to the VHF owner's information since you need to establish a Mobile Maritime Safety Identity (MMSI) number before using the DSC feature. A MMSI number identifies each DSC radio, like a telephone number. The FCC requires a ship station license for all vessels equipped with a marine VHF radio.

Navigation Lights:

The U. S. Coast Guard requires recreational boats operating at night to display navigation lights between sunset and sunrise along with other periods of reduced visibility.

Navigation lights help avoid collisions by improving the night visibility of vessels. Red and green directional lights, white stern lights, white masthead lights and white all-around lights must be displayed in specified positions, depending on boat size, and mode of operation.

Marine Sanitation Devices:

Recreational vessels under 65' with installed toilet facilities must have an operable marine sanitation device (MSD) on board. Vessels 65' and under may use Type I, II, or III MSD's. All installed MSD's must be U.S. Coast Guard certified. The MSD's are labeled to show conformity to the regulations.

Navigation Rules:

The navigation rules establish actions to be taken by vessels to avoid collision. They are divided into Inland/International. Operators of vessels 39.4' or more shall have on board and maintain a copy of the Inland navigation rules.

Navigation Light Rules

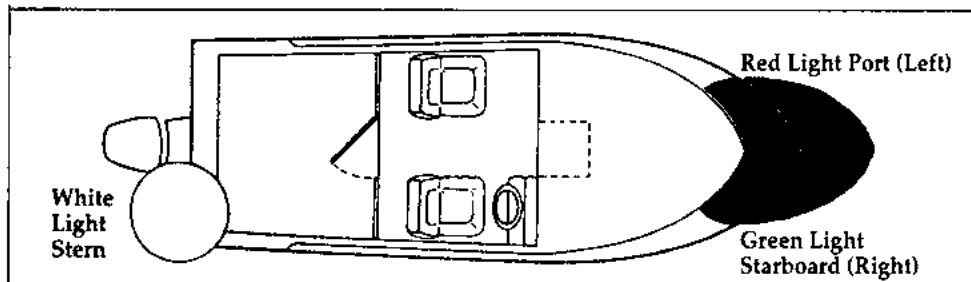

Location of lights on vessel	Visible Range		Degrees of arc lights
	Less than 12 m.	12 m. but less than 20 m.	
Masthead	2	3	225°
All-round	2	2	360°
Side lights	1	2	112.5° each color
Stern light	2	2	135°

figure 1

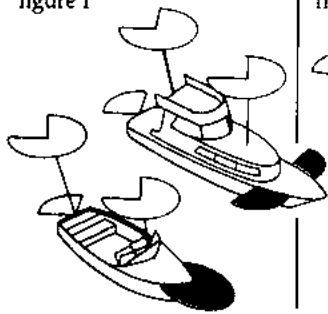

figure 2

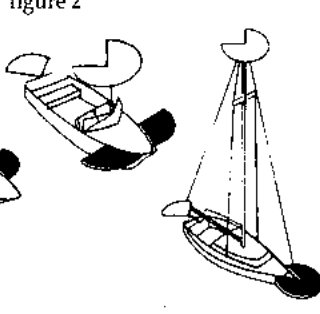

figure 3

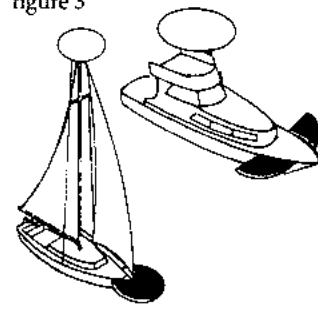

figure 4

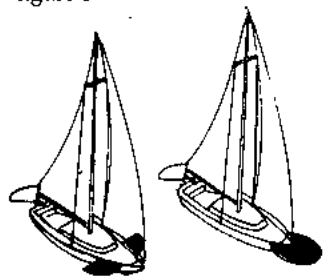

figure 5

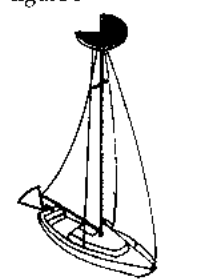
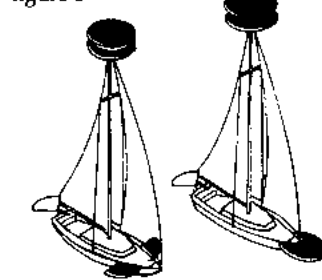

figure 6



Boats less than 12 meters in length

Motorboats or sailboats using power: The lighting arrangements to figure 1, 2 or 3 may be used.

Sailboat using sails alone: The lighting arrangements in figure 4, 5 or 6 may be used.

Boats 12 meters but less than 20 meters in length

Motorboats or sailboats using power: The lighting arrangements to figure 1 or 2 may be used.

Sailboat using sails alone: The lighting arrangements in figure 4, 5 or 6 may be used.

Location of lights

Lights should be located as shown in the drawings.

The masthead light (forward white light in figures 1, 2 and 7d) must be at least one meter higher than the colored lights on a boat less than 12 meters in length and at least 2.5 meters above the gunwale on a boat 12 meters but less than 20 meters in length.

Exceptions

Motorboat or sailboat using power, built before December 24, 1980: The lighting arrangement in figure 1, 2 or 3 may be used. However, the arrangement in figure 3 is not acceptable on a boat that is 12 meters or longer on international waters.

figure 7

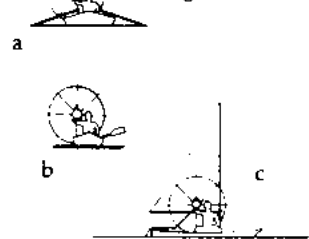

Sailboat using sail alone, less than 7 meters in length: If impractical to display lights in figure 4, 5 or 6, a single white light may be displayed in time to prevent a collision (figure 7c).

Row Boats or Paddle Boats
One all-round white light ready to display in time to prevent a collision (figure 7 a or b).

Great Lakes

figure 7d



Motorboat or sailboat using power on Great Lakes: The lighting arrangements in figure 7d may be used instead of the arrangements in figures 1 and 2.

DISCHARGE OF OIL PROHIBITED

THE FEDERAL WATER POLLUTION CONTROL ACT PROHIBITS THE DISCHARGE OF OIL OR OILY WASTE INTO OR UPON THE NAVIGABLE WATERS OF THE UNITED STATES, OR THE WATERS OF THE CONTIGUOUS ZONE, OR WHICH MAY AFFECT NATURAL RESOURCES BELONGING TO, APPERTAINING TO, OR UNDER THE EXCLUSIVE MANAGEMENT AUTHORITY OF THE UNITED STATES, IF SUCH DISCHARGE CAUSES A FILM OR DISCOLORATION OF THE SURFACE OF THE WATER OR CAUSES A SLUDGE OR EMULSION BENEATH THE SURFACE OF THE WATER. VIOLATORS ARE SUBJECT TO SUBSTANTIAL CIVIL PENALTIES AND/OR CRIMINAL SANCTIONS INCLUDING FINES AND IMPRISONMENT.

Marpol Treaty:

The USCG now enforces the International Convention for the Prevention of Pollution from ships, referred to commonly as the MARPOL TREATY (marine pollution). This international treaty prohibits the overboard dumping of all oil, garbage, ship-generated plastic and chemicals. There is a placard on board your boat (typical example shown) that explains the garbage and plastic dumping laws in detail.

Immediately notify the USCG if your vessel discharges oil or hazardous substances in the water. Call toll free 1-800-424-8802. Report the following information: location, source, size, color, substances and time observed.

No vessel may intentionally drain oil or oily waste from any source into the bilge of any vessel. A bucket or bailer is suitable as a portable means of discharging oily waste.

The placard noted above is normally located in the engine compartment or may be attached to the engine hatch.

Garbage Discharge

THE DISCHARGE OF PLASTIC OR GARBAGE WITH PLASTIC INTO ANY WATERS IS PROHIBITED. THE DISCHARGE OF ALL GARBAGE IS PROHIBITED IN THE NAVIGABLE WATERS OF THE UNITED STATES AND IN ALL OTHER WATERS, WITHIN THREE NAUTICAL MILES OF THE NEAREST LAND.

THE DISCHARGE OF DUNNAGE, LINING, AND PACKING MATERIALS THAT FLOAT IS PROHIBITED WITHIN 25 NAUTICAL MILES FROM THE NEAREST LAND.

OTHER UNGROUND GARBAGE MAY BE DISCHARGED BEYOND 12 NAUTICAL MILES FROM THE NEAREST LAND.

OTHER GARBAGE GREATER THAN ONE INCH MAY BE DISCHARGED BEYOND THREE NAUTICAL MILES FROM THE NEAREST LAND.

A PERSON WHO VIOLATES THE ABOVE REQUIREMENTS IS LIABLE FOR A CIVIL PENALTY OF UP TO \$25,000, A FINE OF UP TO \$50,000, AND IMPRISONMENT FOR UP TO FIVE YEARS FOR EACH VIOLATION, REGIONAL, STATE, AND LOCAL RESTRICTIONS ON GARBAGE DISCHARGES MAY ALSO APPLY.

The act to prevent pollution from ships places limitations on the discharge of garbage from vessels. It is illegal to dump plastic trash anywhere in the ocean or navigable waters of the United States. Also, it is illegal to discharge garbage in the navigable waters of the United States, including the Great Lakes. The discharge of other types of garbage is allowed outside certain specified distances from shore as determined by the nature of that garbage.

United States vessels of 26 feet or longer must display in a prominent location, a durable placard at least 4" x 9" notifying crew and passengers of discharge restrictions.

USA vessels of 26' or longer equipped with a galley and berthing must have a written Management Plan describing the plan for collecting, processing, storing and discharging garbage, and designate the person charged with carrying out the plan.

The placard noted below is usually found near a galley, inside the engine hatch area or close to a trash receptacle.

USCG Minimum Equipment Requirements

Use the chart below as a guideline for assuring your vessel is outfitted to meet USCG standards. Remember to check with local and state authorities for additional equipment requirements. Make sure your vessel certificate of numbers are on the boat, updated and displayed properly according to state requirements. Keep the paperwork on board in a watertight and safe environment. On documented vessels keep both the original and current certificate on board stored in a safe, dry, and accessible location. Also, on documented vessels make sure the vessel name/hailing port are marked on the hull exterior with letters not less than 4" in height. In addition, the Official Number must be permanently affixed on a clearly visible interior structure part of the boat-block type Arabic numbers not less than 3" in height.

Life Rafts

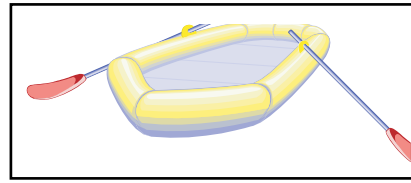

Inflatable life rafts are recommended for ocean going and vessels

operating in a large body of water like the Great Lakes. They provide a shelter for extended periods. If used, make sure it is large enough for all aboard and contains the proper emergency equipment pack. Also, periodically have the unit professionally serviced. Make sure the life raft is Coast Guard approved since it would require meeting a number of stringent material and performance standards.

USCG Minimum Equipment Requirements for Recreational Vessels

Boat Size in Feet	16'	26'	40'	65'	165'
Personal Flotation Devices¹	One Type I, II, III, or V per person		One Type I, II, III, or V per person plus one Type IV throwable		
Fire Extinguishers²					
No Fixed System	One B-I, any type		One B-II or Two B-I	One B-II and one B-I, or three B-I	One or more B-II (vessels 0-50 tons gross) Two or more B-II (vessels 50-100 tons gross)
With Fixed System	No Portables Required		One B-I	Two B-I or one Class B-II	
Visual Distress Signals	Night signals required when operating at night		Minimum of three day-use and three night-use (or three day/night combination) pyrotechnic devices ⁵		
Sound Producing Devices	Horn or whistle recommended to signal intentions or signal position		One bell, and one whistle or horn required to signal intentions or position		
Backfire Flame Arrestor	One CG-approved device on each carburetor of all gasoline-powered engines built after April 1940, except outboard motors				
Ventilation	CG standard system required on gasoline powered vessels with enclosed engine compartments built after August 1980				
Navigation Lights					
Under Power ^{3,4}	Sidelights, Stern Light and Masthead ^{6,7}				
Under Sail	Sidelights and Stern Light ^{8,B}				
Rowing	Same as "Under Sail"				
At Anchor	All-round light, 2nm (at night) or black anchoring ball (during the day) when outside a designated anchorage				
Visibility Range	1nm Sidelights, 2nm all others		3nm Masthead, 2nm all others		5nm Masthead, 2nm all others
Pollution Regulations	"Honor system" (no plaques required)		5" x 8" Oil Discharge placard and 4" x 9" Waste Discharge placard Vessels over 40' with a galley must have a Waste Management Plan		
Marine Sanitation Devices	Vessels with installed toilet facilities must have an operable, CG-certified Type I, II or III Marine Sanitation Device (MSD). Subject to local laws!				Type II or III MSD only
Navigation Rules	Familiarity with the Inland Navigation Rules required		The Inland Navigation Rules ("Rules of the Road") must be kept on board		

<ol style="list-style-type: none"> 1. PFD's must be CG approved, wearable by the intended user and readily accessible. 2. Fire extinguishers required on boats with enclosed engine compartments (not outboards), enclosed living spaces or permanent fuel tanks. 3. Sailboats operating under engine power are considered power driven and must follow the "Under Power" rules. During the day, motorsailing vessels are required to fly a motoring cone. 4. Power-driven vessels under 25' and under 7 knots can substitute a white lantern or torch in place of the required lights. 	<ol style="list-style-type: none"> 5. Non-pyrotechnic substitutes: 1 orange distress flag (day-use) and 1 electric SOS signal light (night-use). 6. All boats under 65' can substitute a single bi-color light for sidelights. 7. Boats under power under 40' can substitute a single all-round light for separate stern and masthead lights. 8. Boats under sail under 40' can substitute a tri-color light for separate sidelights and stern light.
---	---

Additions to these requirements are prescribed by some individual state laws. Check your state's Boating Safety Handbook for a complete list.

Exhaust & Carbon Monoxide

Carbon monoxide (CO) in exhaust can be hazardous, especially from gasoline engines, gasoline generators, grills, stoves, space heaters and on a much smaller degree diesel engines.

CO is a natural by-product of the gasoline engine using an artificial spark. Diesels on the other hand detonate fuel using pressure and temperature. Looking at the two engines another way, gasoline engines use much more oxygen up in the combustion process which contributes to a much higher CO build-up. Although diesels do produce a small amount of CO the combustion process operates with much greater amounts of oxygen which the end result is a much lower CO level.

Ensure that you read the information and follow all the recommendations regarding CO.

Familiarize your crew, passengers and yourself with the sources, symptoms and possible effects of carbon monoxide poisoning. Remember that boats in the same general vicinity can cause your vessel to accumulate dangerous CO levels in the cabin and or in the cockpit.

 WARNING
AVOID SERIOUS INJURY OR DEATH FROM CO POISONING! DO NOT OPERATE THE BOAT WITH PEOPLE HOLDING ON TO THE SWIM PLATFORM OR WITH PEOPLE IN THE WATER.

For safety sake avoid the following:

1. Do not park by other boats with their engine idling or generator cycling for an extended period of time.
2. Do not disable the carbon monoxide alarms installed on your Regal boat. Test units periodically per alarm manufacturer instructions.
3. Do not operate an engine for extended periods of time while in a confined area or where exhaust outlets face a sea wall or bulkhead.
4. Do not operate the engine for an extended period of time with the canvas in the upright and installed position.
5. Do have the engine exhaust system inspected when the boat is in for service.
6. Persons sleeping can easily be overcome by carbon monoxide without realizing it. Do not sleep on board while an engine or generator is running close-by.
7. Do not operate your vessel for extended periods with the bow up in slow cruise conditions especially close behind a vessel being towed or one operating at slow speeds.
8. When underway open all hatches, windshield vents, and main cabin entry door to allow proper airflow from bow to stern.
9. Keep everyone in the water away from the swim platform and generator exhaust outlet areas.

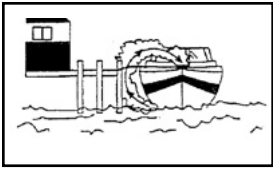

Blockage of exhaust outlets can cause carbon monoxide to accumulate in the cabin and cockpit area even

when the hatches, windows, portholes and doors are open. Sea walls and other confined spaces can cause CO levels to be dangerously elevated.

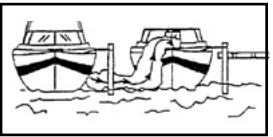

Exhaust from another vessel alongside your boat, while docked or anchored, can

emit poisonous CO gas inside the cabin and cockpit areas.

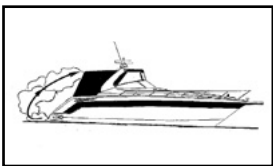

The “station wagon effect” or back drafting can cause CO gas to accumulate inside the cabin, cockpit/

hardtop or bridge areas when the boat is underway, using protective weather coverings (canvas), high bow angle, improper or heavy loading, slow speeds, or at rest. This can occur when traveling behind another boat.

How does CO affect us?

In high concentrations, CO can be fatal in minutes. However, the effects of lower concentrations over a extended period of time can be just as lethal.

Our blood uses hemoglobin to carry the oxygen we breathe to different body parts. Unfortunately, hemoglobin carries CO more readily than it does oxygen. The result is when we breathe in CO it replaces oxygen in our blood and we begin to suffocate. Also, when we are removed from the CO source it remains in our blood for hours causing long term effects. People have been known to become sick and even lose consciousness hours after exposure.

Carbon monoxide accumulation requires immediate

attention! Thoroughly ventilate cabin and cockpit areas. Determine the probable source of the carbon monoxide and correct the condition immediately. Anyone with symptoms of CO poisoning should be placed in a fresh air environment and medical attention found immediately. Regal has installed CO detectors on your boat. Have these detectors professionally calibrated at regular intervals according to the equipment manufacturer’s recommendations.

A Few Notes About Diesel/CO Poisoning

The diesel engine under normal combustion produces much smaller amounts of CO. Therefore, it is far less likely to be fatal to a healthy person. Other factors including weather, temperature and engine condition can greatly affect the unsafe build-up of CO. The best approach is to respect and treat the diesel engine and generator the same way you would a gasoline propulsion system giving particular attention to the sources and possible effects of CO poisoning!

Diesel exhaust in the combustion process produces various components and the captain must be aware that the build-up of these select components over a period of time can cause CO or seasickness like symptoms.

These include carbon dioxide, carbon monoxide (CO), nitrogen dioxide, nitric oxide, sulfur dioxide and others.

A healthy person breathing in sulfur dioxide over a period of time through a diesel engine or generator exhaust can develop nausea. This condition is not life threatening but the person may exhibit CO poisoning or seasickness symptoms. Just never rule out that it could be CO poisoning! Immediately find the source of the problem and move the individual to a fresh air environment!

Symptoms of excessive exposure to carbon monoxide (CO) are:

- Dizziness
- Drowsiness
- Nausea
- Headache
- Ringing in the ears
- Throbbing temples
- Watering, itchy eyes
- Flushed appearance
- Inattentiveness
- Incoherence
- Fatigue or vomiting
- Convulsions

! DANGER

CARBON MONOXIDE IS A TASTELESS, ODORLESS AND INVISIBLE GAS THAT CAN CAUSE DISCOMFORT, SEVERE ILLNESS, AND EVEN DEATH. EXERCISE CAUTION WHILE OPERATING GENERATOR OR ENGINES IN CONFINED SPACES OR AT DOCK SIDE. DO NOT ALLOW HULL EXHAUST OUTLETS TO BECOME BLOCKED OR EXHAUST FUMES CAN BECOME TRAPPED IN AND AROUND THE CONFINES OF YOUR BOAT. DURING IDLE AND SLOW CRUISE CONDITIONS, BILGE BLOWERS MUST BE USED.

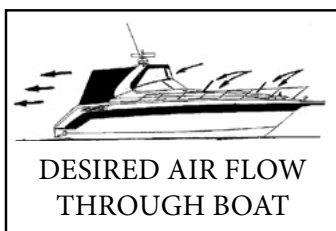

To help prevent carbon monoxide (CO) accumulation, ventilate your cabin and cockpit while

underway. Open a forward hatch, porthole or window to allow air to travel through the boat's interior and cockpit. See the illustration for desired airflow.

NOTE: Never occupy moored boat with engines running and/or canvas covering vessel.

! WARNING

INSPECT THE EXHAUST SYSTEM. IMMEDIATELY REPAIR OR REPLACE LEAKING, CRACKED AND CORRODED, OR MISSING EXHAUST COMPONENTS.

- Before each trip inspect engine, generator and all CO detectors. All must be working properly.
- Make sure all exhaust hose clamps are in place.
- Look for exhaust leaking from the exhaust system components, indicated by rust and or black streaking, water leaks, or corroded or cracked fittings.
- Inspect all rubber exhaust hoses for burned or cracked areas. All rubber hoses should feel soft and be free of kinks.
- Visually verify that water exits at the engine exhaust outlet.
- Keep an ear tuned for changes in exhaust sound that may be an exhaust component malfunction.

Do Not Operate the Vessel If **Any** of the above conditions exist. Contact a marine professional!

NOTICE

CARBON MONOXIDE PRECAUTIONARY LABELS ARE LOCATED AT THE HELM, TRANSOM AND CABIN. ENSURE THAT ALL ABOARD READ AND UNDERSTAND THE SIGNS AND EFFECTS OF CARBON MONOXIDE (CO).

Boating & Alcohol



Operating a vessel while intoxicated became a specific federal offense effective in 1988. The ruling set federal standards for determining

when an individual is intoxicated. If the blood alcohol content (BAC) is .10% (.08 in some states) or higher for operators of recreational vessels being used only for pleasure are subject to a civil penalty up to \$1,000 or criminal penalty up to \$5,000, one year imprisonment or both. In some states the fines and imprisonment may increase significantly.

The effects of alcohol and drugs account for the highest single cause of marine accidents and deaths. Most deaths in boating accidents occur when someone falls into the water. Balance is one of the first things you lose when drinking alcohol or under the influence of drugs. The problem arises out of not knowing your balance is restricted.

Overall vision is reduced by alcohol especially at night, along with double or blurred vision. Peripheral vision is lessened which restricts seeing vessels or objects on the side. Also, color awareness decreases especially with red and green which happen to be the colors of boat navigation lights, buoys, and channel markers.

Alcohol will greatly increase your heat loss so it increases the effects of hypothermia. Finally, your ability to make correct judgements in emergency situations is greatly reduced. Alcohol takes away the brains ability to process information quickly and delays a persons reaction time.

Don't drink and drive!

Alcohol Myths & Facts:

Myth: Beer is less intoxicating than other alcoholic beverages.

Fact: One 12 oz. can of beer has about the same amount of alcohol as a 5 oz. glass of wine or a shot of liquor.

Myth: Black coffee, fresh air, and a shower will sober the effects of alcohol.

Fact: After consuming alcohol time is the only thing that will sober you up. Our bodies average burning 1 oz. of alcohol every hour. If a person is drunk, it will take a person seven or more hours to sober up.

Myth: Telling if a person is too drunk to operate a vessel is easy.

Fact: Many experienced drinkers have learned to compensate for the visual effects of alcohol and can disguise their drunk condition.

Myth: You can judge if you are fit to operate a boat.

Fact: Judgement is one of the first elements you lose when drinking.

Boating Accidents

The following is a list of common causes of boating accidents. Be aware of them and take the necessary steps to ensure that yourself and crew are educated and prepared to act in an emergency.

1. Mixing boating and alcohol. Remember, the skipper is responsible for his crew, passengers and vessel.
2. Trying to reach the bow by the deck walk-around at unsafe speeds. Use the center walk-through.
3. Someone sitting on the bow, deck, or swim platform while underway.
4. Choosing a boating outing day with inclement weather, especially in high winds and thunderstorms in the forecast or staying out when bad weather is approaching.
5. Disembarking without checking all the fluids or systems, and especially fuel system components.
6. Not monitoring the boating traffic or possible obstructions around you.
7. Emergency communications equipment, signaling devices, and navigation lights not working.
8. Improper boat handling especially high speed turns in rough water. Using trim improperly.
9. Being too far from shore with inadequate fuel supply or navigational aids.

10. Passengers, especially children that are not wearing the proper life saving devices.

11. Skipper or passengers not seated in the boat.

Reporting Boating Accidents:

According to the Federal Boat Safety Act of 1971 involving collision, accident or other casualty, the operator must make a formal report within 48 hours to the nearest state boating authority when the incident involves:

1. Death
2. Injury requiring treatment other than first aid
3. The disappearance of someone from a boat under death or injury circumstances.

A formal report must be made within 10 days for accidents involving more than \$2000 damage or complete loss of vessel.

For information regarding accident reporting, please call the Boating Safety Hot-line at: 800-368-5647.

If there is no state provision for reporting boating accidents a report must be made to the Coast Guard officer in charge, Marine Inspection Unit nearest to the accident site or USCG station.

Federal Regulations Regarding Vessel Security

Federal maritime regulations contain specific information when operating near naval vessels, oil tankers and cruise ships.

1. You may not approach within 100 yards of any U.S. naval vessel, oil tanker, or cruise ship. When this is impossible to avoid, you must contact either the vessel or the Coast Guard escort vessel on channel 16 of the VHF radio.
2. Also, you must operate at minimum speed within 500 yards of these vessels.

Rendering Assistance

The operator of a vessel is obligated by law to provide assistance that can be provided safely to any individuals in a dangerous situation on the waterway. The operator is subject to fine and or imprisonment for failure to do so.



WARNING

Do not approach within 100 yards of any U.S. naval vessel. If you need to pass within 100 yards of a U.S. naval vessel in order to ensure a safe passage in accordance with the Navigation Rules, you must contact the U.S. naval vessel or the Coast Guard escort vessel on VHF-FM channel 16.



OPERATE AT MINIMUM SPEED

You must operate at minimum speed within 500 yards of any U.S. naval vessel and proceed as directed by the Commanding Officer or the official patrol.

Violations of the Naval Vessel Protection Zone are a felony offense, punishable by up to 6 years in prison and/or up to \$250,000 in fines



DANGER

AVOID BODILY INJURY OR DEATH FROM FALLING OVERBOARD! ALL OCCUPANTS SHALL STAY SEATED IN THE COCKPIT WHILE THE BOAT IS RUNNING.

Water Sports

Besides learning the safety precautions for safe boating, as well as understanding and knowing required rules and regulations you are obligated to be particularly careful around other water sportsman, such as scuba divers, water skiers, wake boarders, and fisherman.

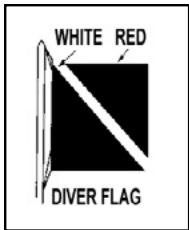

Whenever you see a “Diver Down” flag maintain a distance of at least 100 feet on inland waters. In bays and open waters stay 300 feet away. The flag indicates a diver in the water. If a diver is operating from your boat, be certain to use this flag and post a lookout on board to observe the diver’s air bubbles.

Swim Platform:

On all types of swim platforms you should make periodic inspections of the swim ladder and hardware that support the platform to ensure that all connections and fittings are tight and in good condition. Always insert ladder and install the cover before making headway!

Be alert! When operating the boat in reverse insure that water does not accumulate excessively on the platform or transom, especially in rough seas or strong currents. If installed, do not exceed the recommended maximum capacity label!

Typical label shown (vary by platform type/model).



WARNING

AVOID SERIOUS INJURY OR DEATH!
DO NOT OPERATE THE BOAT
WITH PEOPLE IN THE WATER
ON TOP OR HOLDING ON TO
THE SWIM PLATFORM STRUCTURE.

Read and understand the warning label above regarding “teak surfing.”

Fishing



Most boaters fish from time to time. With the propulsion systems of today it is possible to fish in out-of-the-way

places. When cruising, stay clear of fisherman. They may have lines or nets out which might be cut or get caught in your propeller if you come too close. Slow down when approaching fishing boats. Do not return to cruising speed until the boats have been passed. If a fishing boat should be anchored, a large wake could flip or swamp the boat, upset fishing gear, pull the anchor loose from the bottom or worse yet cause someone to fall overboard.

When fishing from your boat, never anchor in a shipping channel or tie up to any navigational aid. These must be kept clear of at all times. Be sure to carry a local chart of the area to back up your plotter and be on the lookout for shallow water and hidden obstructions. Many times local conditions change and there is a time lag on the plotter chip until the next revision. Pick up a tidal chart if appropriate so you do not end up grounded.

Weather / Water Conditions



Before a boating outing check the weather conditions. As we all know the weather can change rapidly in many parts of the country. It does so sometimes without being predicted. NOAA weather radio reports are continuously available on designated frequencies installed on VHF radios and various hand held devices.

Also, many local radio stations carry weather reports along with on-line information.

Cloud Formations:

Clouds indicate the type of current weather and upcoming changes in the weather. Knowing the type of cloud formation can assist you in understanding current weather. Flat clouds (stratus) normally indicate stable air. Cumulus clouds indicate unstable air.

Many times a “cotton ball” or cumulus cloud builds vertical height in the afternoon and the result is a thunderstorm with increased winds and waves; sometimes these storms are quite violent.

Also, water spouts with high vortex winds can develop over water. You can find additional weather information (meteorology) on the internet.

Waves & Fog:

As the wind blows across water waves are created. The stronger the wind and increased distance across the water enlarges the wave action. Other factors that can cause problem situations for vessels are fog, currents, and tidal changes.

Fog can develop inland on clear, calm mornings. Coastal areas see large “blankets” of fog roll in and stay for extended time periods sometimes causing hazardous navigation conditions. If you are caught in the fog, do not panic. Think of the best plan of action and proceed carefully. If you are limited in navigation equipment at the first sign of fog proceed to the nearest shoreline and wait until the fog lifts.

Boats equipped with navigation equipment, local waterway experience and charts should proceed to a safe harbor. Use extreme caution, signal as needed, and reduce to a speed where you can stop within half of your forward vision range.

If foul weather catches you at sea do the following:

1. Slow down. Proceed with caution and put on your life vests.
2. Try to reach the nearest safe shoreline.
3. Navigate your vessel slowly into the waves at a 45 degree angle.
4. Passengers should sit low in the center of the vessel.
5. Monitor your bilge pump. Make sure sump stays free of water.
6. Secure loose gear. Make ready emergency equipment.
7. Anchor over the bow but never over the stern.

Chapter 3

Rules Of The Road

Navigation Rules Defined

The Navigation Rules set forth actions to be followed by boats to avoid collision. They are referred to as the “Rules of the Road”. There are two main parts referred to as the inland and international rules. The inland rules apply to vessels operating inside the boundaries of the United States. The international rules (referred to as 72 COLREGS) apply to vessels operating on the high seas and all connected waters outside the established demarcation boundaries. Most navigational charts show the demarcation lines by red dotted lines and are published in the navigation rules. Remember to consult state and local agencies since areas such as “no wake zones,” swimming beaches, “diver down flag” and inland landlocked lakes fall under their responsibilities. This section is only an introduction to the “rules of the road”. We strongly recommend additional training before getting behind the wheel.

Order Inland & International Navigation Rules from:

Superintendent of Documents
U. S. Government Printing Office
Washington, DC 20402
Tel: (202-512-1800) Fax:(202-512-2250



Navigation Rules

Right Of Way:

1. Cross waves at right angles.
2. When caught in heavy water or squalls, head either directly into the waves or at a slight angle. Reduce speed, but maintain enough power to maneuver your boat safely.
3. Keep your speed under control. Respect the rights of other boaters engaged in all water sports. Give them plenty of operating room.
4. Whenever meeting a boat head on, keep to the right where possible.
5. When two boats cross, the boat to the right (starboard) has the right of way.
6. When overtaking or passing, the boat being passed has the right of way.
7. In general, boats with less maneuverability have right-of-way over more agile craft. The skipper must keep his craft clear of the following vessels:
8. A vessel not under command or aground; due to their circumstances, these vessels have no maneuverability.

9. A vessel restricted in its maneuverability; these vessels usually are performing work which limits their maneuverability. Examples are boats surveying, dredging, laying pipe or cable, or servicing navigational markers.
10. A vessel engaged in fishing; these include boats fishing with lines, trawls or nets, but not trolling lines.
11. Sailboats; they have the right-of-way over powerboats. However, if a sailboat is using a prop to move forward, it is considered a powerboat even if the sails are up.
12. Remember the unwritten “rule of tonnage”. Basically a smaller tonnage vessel should take every effort to avoid close quarters with a larger tonnage vessel. One way to accomplish this is to have a designated human lookout to “eyeball” the horizon for any developing collision course.
13. Use defensive driving skills on the waterway just as you do on the roadway. The other vessel may not know the rules of the road. Be alert and ready to take immediate action.
14. If a collision course is unavoidable neither boat has the right of way. Both boats must react to avoid an accident according to the rules of the road.

Lookouts:

International and Inland navigation rules spell out the specifics of establishing a lookout. A lookout is legally defined by the court system as a person who has specifically charged duties on board such as observing sounds, echoes, lights and any inhibitors to navigation with complete thoroughness as permitted by the circumstances.

The term “specifically charged” means that the lookout has no other duties at that time that could prevent him from keeping a proper watch.

Of course the skipper must delegate the lookout duties to a seasoned crew member who can react to events quickly and communicate effectively with the captain with little notice.

As captain of your yacht you are responsible for the vessel and the crew. Choose an experienced individual as lookout and review the navigation rules with this person so he can make the right call quickly as situations develop.

Navigation Rules

The Navigation Rules set forth 3 types of crossing situations- crossing, meeting, and overtaking. In each case, both boats are governed by special procedures.

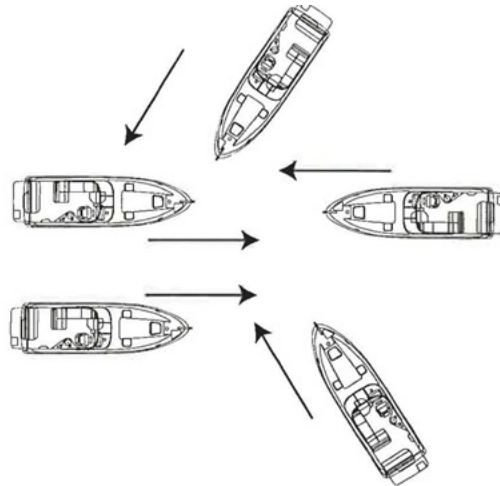

In a head-on meeting, both vessels must sound a single blast to give way toward starboard and pass to port.

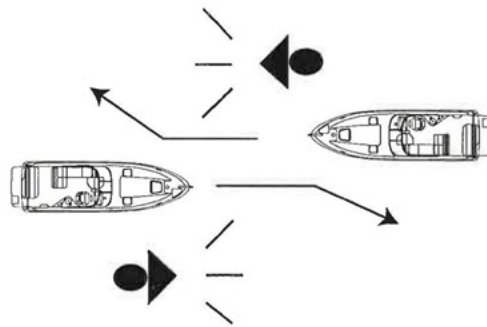

These rules appear when there is a risk of collision. In a crossing situation be aware of the other craft's position. For safety, there should be a noticeable change in the angle, bow or stern; a gradual change in position indicates possible danger.

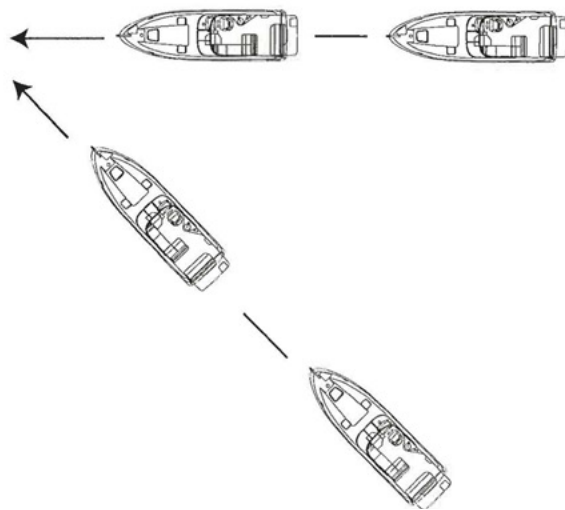

Navigation Rules

An overtaking boat is burdened, and is not the privileged craft, even though it approaches the danger zone of the overtaken boat.

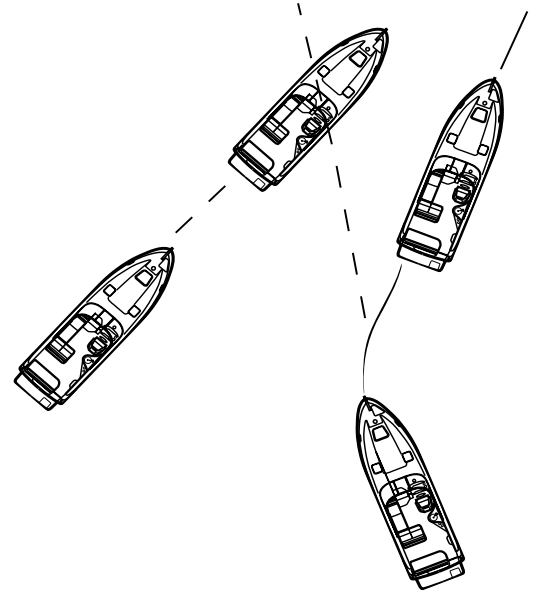

The overtaking boat first signals with a single blast if that boat desires to pass on the starboard side of the boat ahead, or a double blast if passing to port. The overtaken craft responds with the same signal if safe, or with the danger signal (5 short blasts or more) if unsafe. The boat overtaking must not pass unless the appropriate signals are sounded.

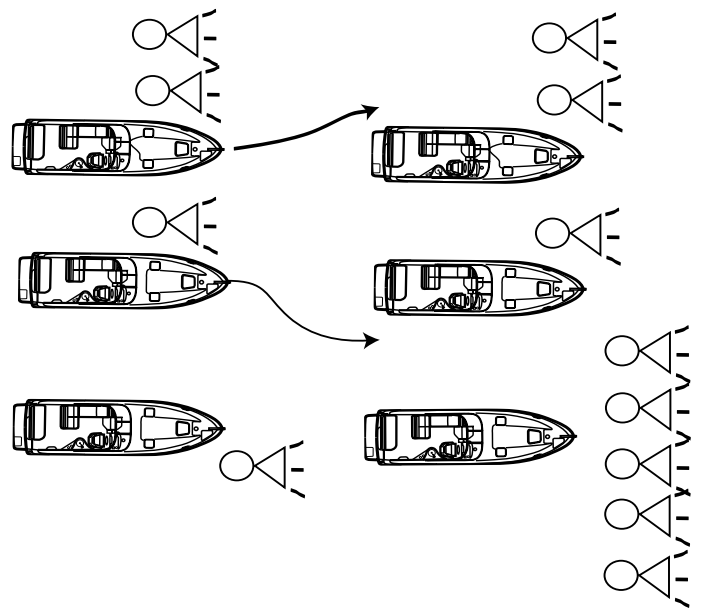

Navigation Aids



Navigation aids are placed along coasts and navigable waters as a guide for mariners in determining their position in reference to land and hidden danger. Each aid provides specific information.

They form a continuous system of charted markers for monitoring on the plotter or providing accurate piloting on paper as a backup.

Your on board plotter provides up to date navigation aids. Besides coastal maps a complete domestic interior waterway grid is featured on the plotter.



NAVIGATION LIGHT IN PUGET SOUND, WA.

If desired, there are hand-held GPS devices that are available as back-up devices. In addition, nautical charts are provided by the National Ocean Service (NOS) and are distributed nationwide through marinas and outlet stores. These charts show the geography of the coast, water depth, landmarks, navigation aids (buoys and markers), marine hazards, and port facilities. Use only up-to-date charts for navigation. We recommend when purchasing a chart to look for the weather resistant ones. Buoys provide a road map to keep the skipper on course and to avoid hazards. Buoys are identified by light, shape, color and in severe weather conditions by sound.

Buoys or beacons called lateral markers indicate the port and starboard sides of the waterway to be followed. U. S markers follow the buoy age system known as Red Right Returning. When returning from sea or traveling upstream, the green markers are to port (on your left) and the red markers are to the starboard side (on your right). When traveling downstream or out to sea the marker color would be reversed.

Before operating your vessel, learn to identify the various navigational aids such as lateral aids, mid-channel markers, information and regulatory markers.

NOTICE

SKIPPERS MUST NOT RELY ON BUOYS ALONE TO MARK THEIR POSITION. SEVERE WEATHER CONDITIONS AND WAVE ACTION CAN ALTER A BUOYS POSITION. NEVER TIE UP TO A BUOY. IT IS ILLEGAL AND DANGEROUS.

Lateral Aids

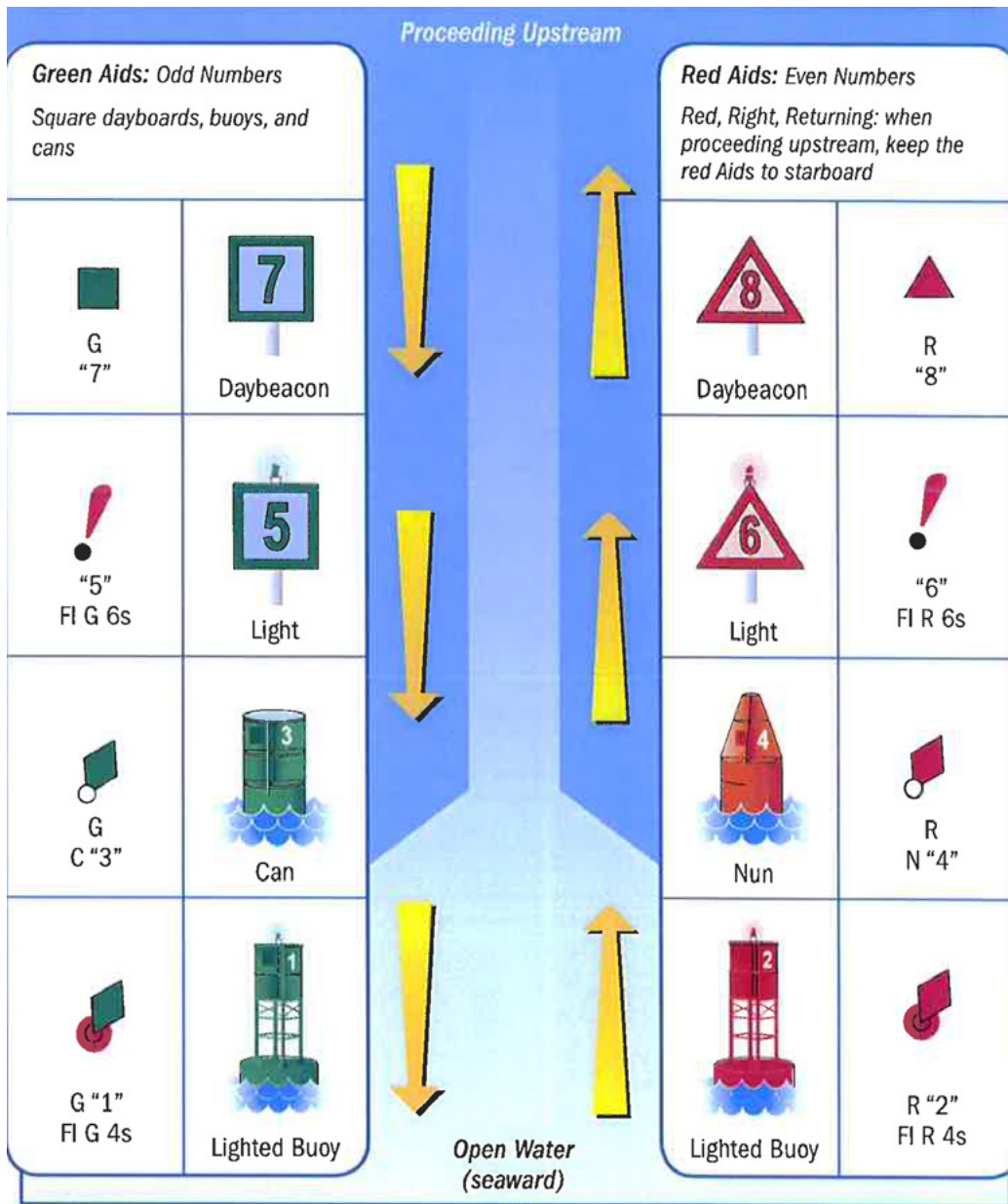

Characteristics

- Beacons may have green odd numbers.
- Buoys may have white odd numbers.
- If lit, the light will be green and is likely to flash in one of the following patterns:













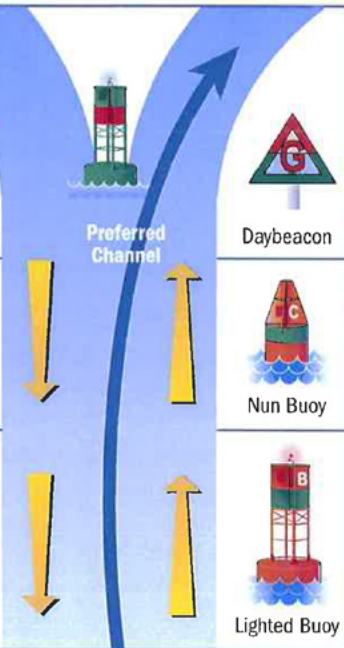

Flashing (2)	
Flashing	
Occulting	
Quick Flashing	
Isophase	

Characteristics

- Beacons may have red even numbers.
- Buoys may have white even numbers.
- If lit, the light will be red and is likely to flash in one of the following patterns:

Flashing (2)	
Flashing	
Occulting	
Quick Flashing	
Isophase	

Channel Markers

 GR "U"	 Daybeacon		 Daybeacon	 RG "G"
 GR C "S"	 Can Buoy		 Nun Buoy	 RG N "C"
 GR "A" Fl (2+1) G 6s	 Lighted Buoy		 Lighted Buoy	 RG "B" Fl (2+1) R 6s
Characteristics <ul style="list-style-type: none"> Green on top. Have a letter designation. Buoys will feature a white letter. If lit:  COMPOSITE GROUP FLASHING (2-1) 			Characteristics <ul style="list-style-type: none"> Red on top. Have a letter designation. Buoys will feature a white letter. If lit:  COMPOSITE GROUP FLASHING (2-1) 	

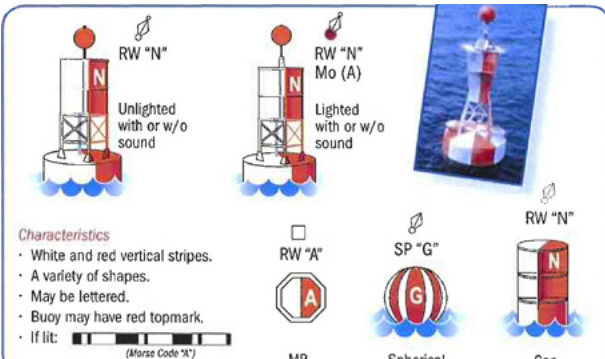













Characteristics

- White and red vertical stripes.
- A variety of shapes.
- May be lettered.
- Buoy may have red topmark.
- If lit:  (Morse Code 'N')

MR Spherical Can

Regulatory Markers

Symbol	Meaning	Examples
	Danger A diamond shape alerts boaters to hazards	 
	Restricted Operations Marks with a circle indicate areas with regulated operations	 
	Exclusion A diamond shape with a cross means boats are prohibited from the area	 
	Information Marks with a square provide helpful information such as directions, distances, and locations	 

Night Running

Boats operating between sunset and sunrise (hours vary by state), or in conditions of reduced visibility, must use navigation lights. Night time operation, especially during bad weather and fog, can be dangerous. All Rules of the Road apply at night, but it is best to slow down and stay clear of all boats regardless of who has the right-of-way.

To see more easily at night, avoid bright lights when possible. Also, it is helpful to have a passenger (appoint as lookout) keep watch for other boats, water hazards and navigational aids.



To determine the size, speed and direction of other vessels at night, use the running lights. A green light

indicates starboard side, and a red light indicates port side. Generally, if you see a green light, you have the right-of-way. If you see a red light, give way to the other vessel.

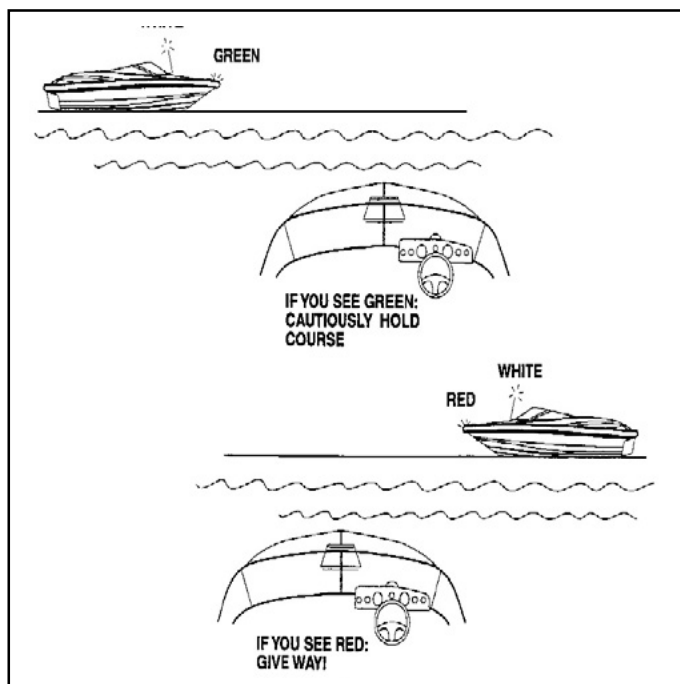

Bridge Clearance



Be aware that your vessel requires a specified bridge clearance height. This height is a measured estimate from the waterline to the top of the highest equipment height. The estimated height can change because of variances in the loaded condition of the vessel and equipment variances. See the bridge clearance specs in Chapter 12.

Some bridges are tendered. Know and use the proper bridge signals when approaching these bridges (see bridge signals in this chapter). You can also monitor and communicate on channel 13 of a VHF radio for bridge information in most domestic locals. Other bridges are marked with a clearance measurement and you are on your own. Appoint a look out for additional visual assistance when entering a bridge zone.

After determining your vessel will clear the bridge proceed with caution at a safe idle speed. Keep your eye on vessel traffic at all times in order to react quickly. Keep both hands on the helm since you may need to change course because of current and wind conditions. Resume a safe speed once clear of the bridge structure and acknowledgment of clear visibility. Just use common sense!



Bridge lighting is maintained by the Department of Homeland Security. On the following pages are 2 typical examples of night-time bridge lighting.

As the skipper approaches bascule and fixed bridges light position (arc of visibility) and color will indicate the safe channel through the bridge.

Notice green denotes the “safe” entry location on single-span bridges and green or white on multiple-span bridges designates the main channel. In addition, green denotes the “up” position for single and double lift bridges as seen above.

WHISTLE SIGNALS

ONE LONG BLAST: Warning signal
(Coming out of slip)

ONE SHORT BLAST: Pass on my port side

TWO SHORT BLASTS: Pass on my starboard side

THREE SHORT BLASTS: Engine(s) in reverse

FOUR OR MORE BLASTS: Danger signal

BRIDGE SIGNALS

SOUND	VISUAL	DAY (Flag)	NIGHT (Lights)
VESSEL: Open	—●	↑	↑
BRIDGE: OK	—●	□	○
No	●●●●●	↓	●
VESSEL: Replies:	●●●●●	Same	Same
RADIO: VHF CH. 13		No	No

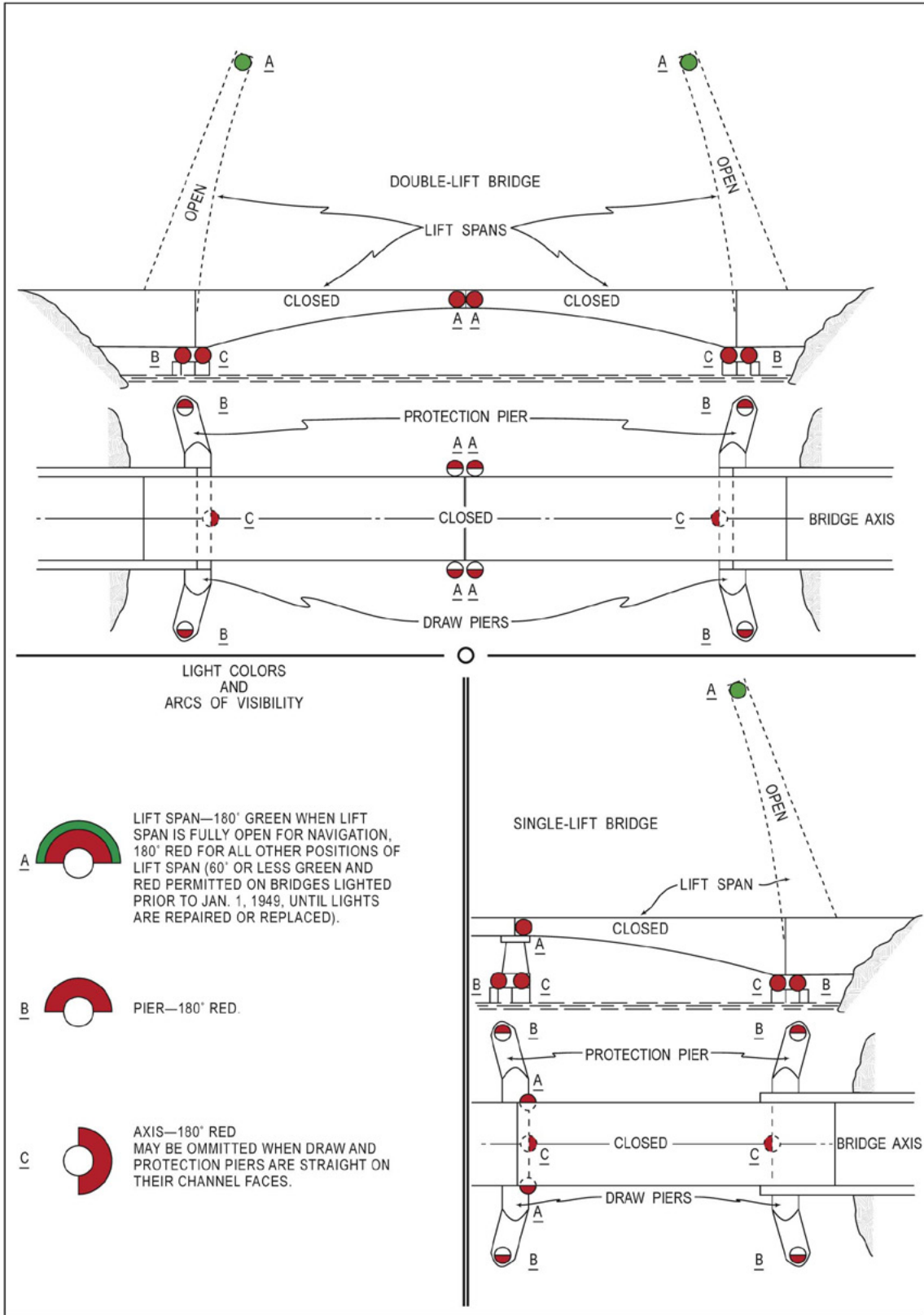

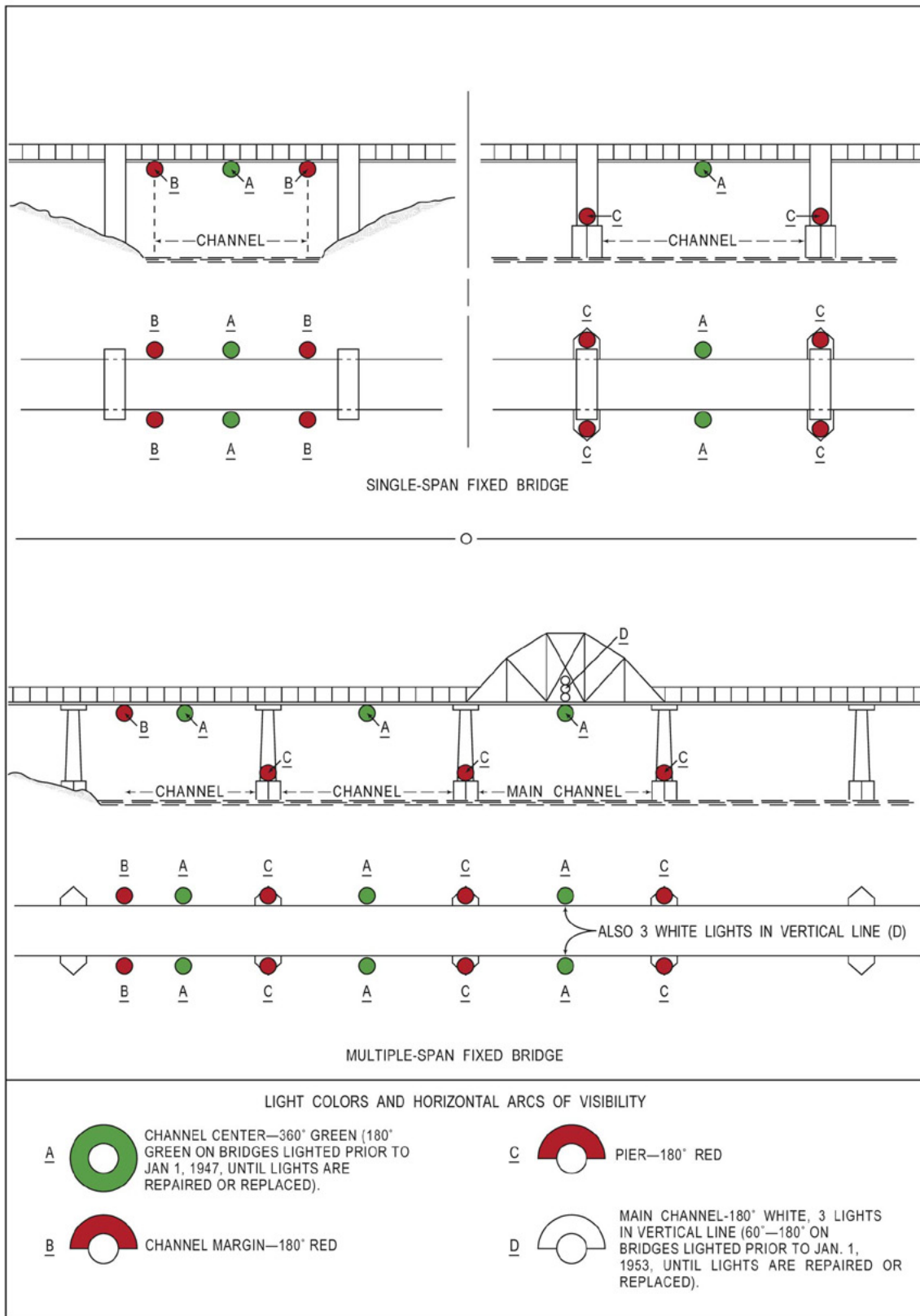

Chapter 4

Systems

Overview

In this chapter Regal on board systems are introduced. Information includes several main systems including fire protection, fuel, electrical, water, waste, electronics, entertainment and trim tabs. In short, this chapter is the “meat and potato” section for systems. Basic information discussed applies to stern drive and outboard models.

A system description, location of components, and operational information is found in this section. Enhanced vendor component details and troubleshooting can be found in the owner’s information packet along with the troubleshooting chapter of this manual.

Be sure to read and follow any danger, warning, or caution labels in reference to boat systems or individual equipment components.

Note that your Regal boat may not contain all of the equipment or systems shown. Regal has the right to modify, update or delete equipment and/or systems at anytime. Refer to the vendor documentation located in the owner’s information packet for more detailed information of individual system components and/or the chapter on equipment operation.

 **WARNING**

PREVENT INJURY OR DEATH!
READ AND UNDERSTAND THE
PROPULSION AND GENERATOR OWNER'S
MANUAL BEFORE ATTEMPTING
TO OPERATE THE VESSEL.

Fire Protection

Automatic Fire Extinguishing System



Vessels offering generators use both a powered ventilation (blower) system and a fire extinguishing system in the sump capable of automatic and manual activation. The dash monitor utilizes an instrument display unit light that provides the operator with a system status of a charged or uncharged condition by an audible alarm and icons. With the ignition switch “on” and a no light condition it indicates that the

system has been discharged.

If the fire extinguishing system should discharge the ignition system will be instantaneously interrupted and the engines will shut down. See the automatic fire extinguisher manual in the owner’s packet for additional details.



If a fire has started in the engine compartment the system will automatically discharge or the operator can manually discharge the extinguisher. Find the system manual cable assembly located in the cockpit. To use the manual remote remove the safety pin from the

“Fire T Handle” and pull firmly on the “Fire” handle which will activate the fire extinguisher unit in the engine compartment. A loud “rushing air” sound may be heard. Complete discharge will take several seconds. Keep the compartment closed for a period of time sufficient to permit the agent to soak all areas of the protected space. This allows hot metals and fuel time to cool. Refer to the automatic fire extinguisher owner's manual for additional information.

Note: The boat operator needs to educate the crew on fire protection and more specifically the automatic fire extinguishing system in the event that he becomes incapacitated. It is a good idea to practice by having a mock fire drill.

Portable Fire Extinguishers

Clean agent extinguishers are primarily for Class B and C fires; (gasoline is a flammable liquid under the Class B group). The extinguisher should be of the 5 lb. capacity and 2 are recommended based on the maximum capacity of the fuel tank onboard and the boat length. These extinguishers may be available from your dealer, marine speciality stores, or on the internet. It is recommended to carry extra portable fire extinguishers to backup the automatic fire extinguisher system since a fire could take place in an area outside of the sump/machinery space.

As noted above a clean agent type of liquefied gas used today is FE-241. This gas is colorless and odorless, heavier than air and sinks to the lower parts of the sump to extinguish fires. Since the year 2000 ingredients have changed to a more environmental friendly formula (Chlorotetrafluoroethane or FE-241). FE-241 is used in portable-hand units.

The canister needs to be weighed once a year. Also, the canister is engraved with a date which is part of the canister life cycle. Refer to the information regarding fire prevention in this manual and on the internet. Normally the clean agent fire extinguishers cost more than powdered or CO₂ extinguishers.

Electrical System

Overview

In this section, basic DC (direct current) and AC (alternating current) electrical systems are introduced. Select electrical components are reviewed along with their location and function within the electrical system.

There may be instances where stern drive and outboard information is mixed. In such cases wording is used to differentiate products for the reader.

For more complicated issues outside the scope of this manual contact your closest Regal dealer. They have undergone extensive training on the Regal boat systems.

Be sure to read and follow any danger, warning, caution, or notice labels in reference to the vessel's electrical system or individual equipment components. Also, refer to the owner's packet for further product safety information or the internet.

Note that electrical panels shown in this manual and the actual ones on your vessel may appear slightly different as Regal is constantly updating components.

 WARNING
PREVENT SEVERE INJURY OR DEATH! DISCONNECT ALL ELECTRICAL POWER SOURCES BEFORE ATTEMPTING TO REPAIR OR REPLACE ANY ELECTRICAL COMPONENT.

Main DC Panel Breaker Panel

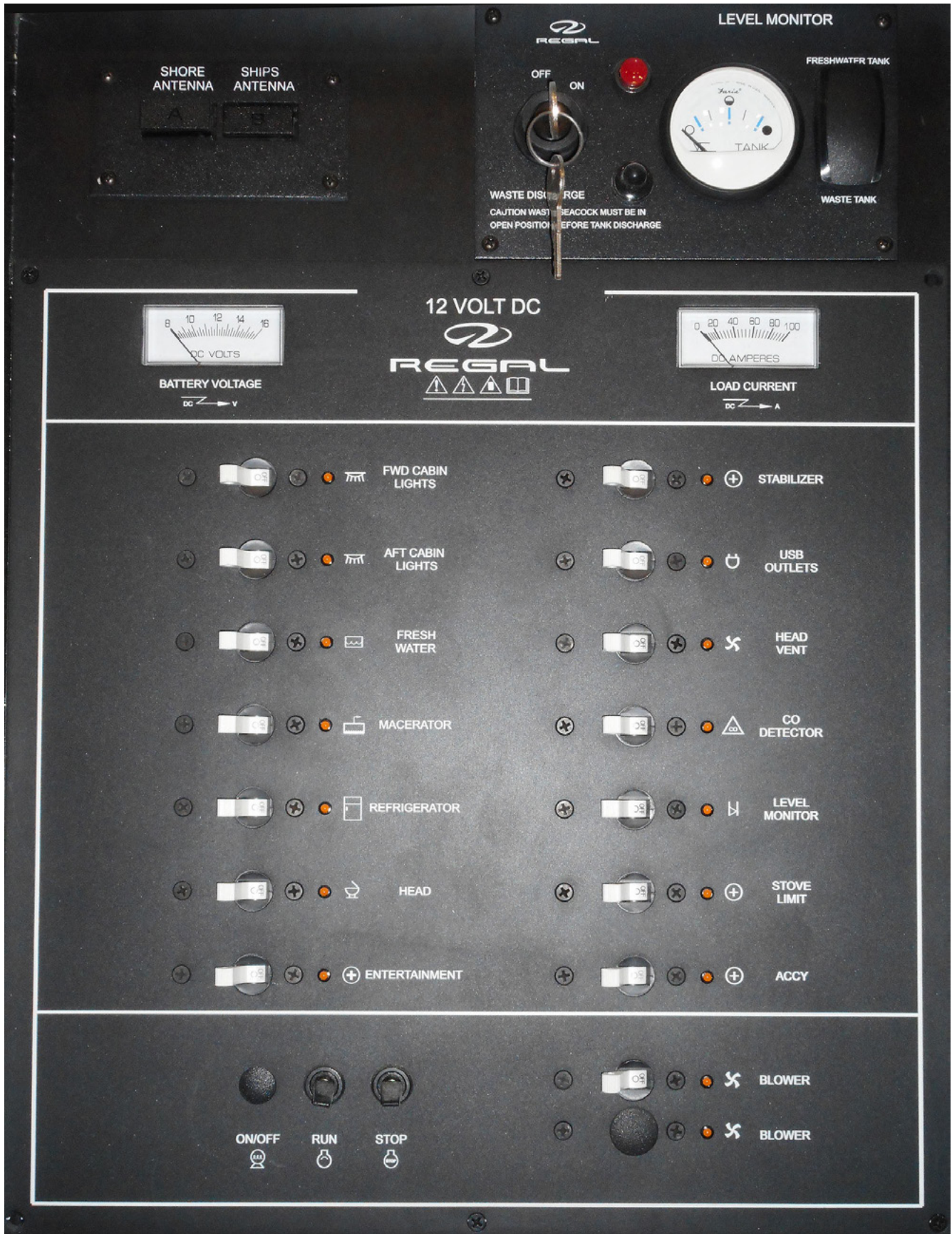

Main DC Panel Breaker Panel Description

Note that breakers controlling components at the main DC panel may change in the production cycle. Regal retains the right to improve or change the product at any time.

Meters

Battery Voltage- This meter measures the direct current battery voltage as taken from the house battery. With engines running battery voltage will increase indicating the charging system is performing properly.

Load Current- This meter measures the amount of DC current being used (amperage). Components using motors to do their job demand more amperage. This current is drawn from the battery reserve energy supply when engines are idle and of course is replenished with the engine alternator/stator charging system.

Breakers

Fwd Cabin Lights- This breaker controls the overhead, under counter and direct lighting in the main stateroom, head, shower, atrium, and salon.

Aft Cabin Lights- This breaker controls the overhead, under counter and direct lighting in the aft stateroom and cockpit (patio).

Fresh Water- This breaker controls the fresh water pressure pump which supplies water to faucets, wash down, transom shower and onboard head.

Macerator- This breaker controls the waste pump. This pump grinds up waste before sending it up through the deck fitting during a pump-out procedure or through the bottom seacock during an overboard discharge procedure. Be familiar with all dumping laws before performing an overboard discharge through the boat bottom.

Refrigerator- This breaker controls the salon galley refrigerator when the vessel is at sea not using generator.

Head- This breaker controls the vacuum style head toilet motor and flushing components,

Entertainment- This breaker controls low voltage components used only with the KVH optional satellite TV system.

Stabilizer- This breaker controls the Seakeeper unit which offsets the wave action of the vessel.

USB Outlets- This breaker controls the USB outlets throughout the vessel which permit charging of phones and other mobile devices.

Head Vent- This breaker controls the head vent blower. This component aids in the removal of odors.

CO Detector- This breaker controls the CO detectors which provide protection against carbon monoxide.

Level Monitor- This breaker controls the level monitor panel. This component provides the levels of the potable water tank and waste tank.

Stove Limit- This breaker controls the activation of the stove switch located in the galley cabinet under the stove cover track. With the stove cover removed from the stove and placed on the cabinet track provided it allows the stove to energize.

Accy- This breaker controls any aftermarket components added to the vessel. Ensure that the breaker size is the proper size to protect the component. See your closest Regal dealer for further information before adding any DC device.

Additional DC Main Panel Controls

Blower- The blower breaker at the bottom of the main DC ship's panel is for the generator. Newer panels feature a single pole blower breaker for the generator blower system (3). Activate the blowers for at least 4 minutes before starting the generator. Run blowers while generator is operating.

As part of the blower circuit the relay panel uses 15 amp time-delay fuses mounted in the bilge. There is one for each of the 3 blower motors for overload protection. A safety cover protects the fuses. See the photo to the right.

Antenna Switch- Depress the shore switch to amplify the HDTV signal when moored. Also, when docked the system is connected to the ship's TV coaxial inlet on the transom and the marina dock coaxial inlet. See entertainment in the systems chapter for more information.

Waste Discharge- When key is in the "OFF" position the waste discharge cycle is interrupted. When key is in the "ON" position and the red button is pushed the waste discharge pump is activated. Always ensure sea cock is in open position prior to overboard discharging.

Understand the local, state, and federal legislation regarding the overboard discharging of waste before activating the pump-out cycle.

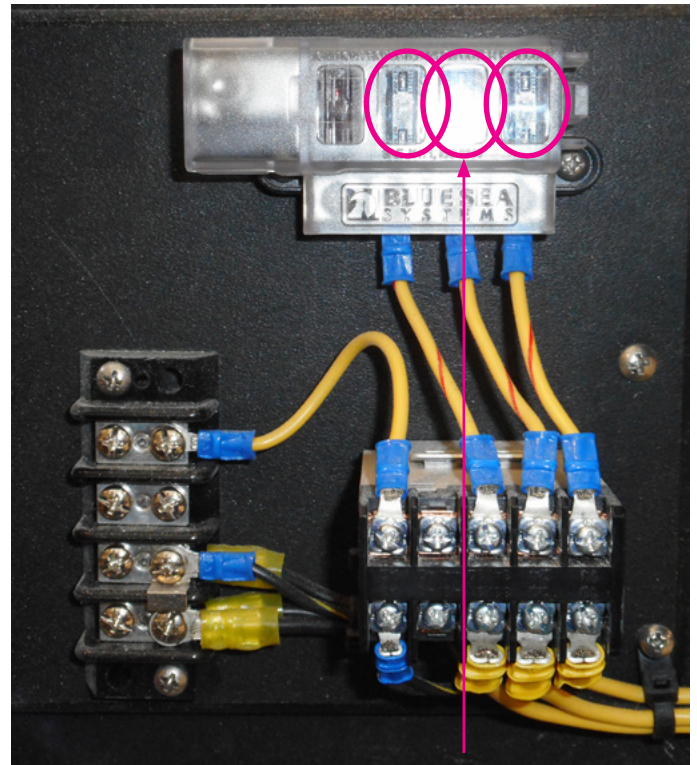

BLOWER RELAY PANEL SHOWING INDIVIDUAL FUSES WITH COVER

DC Switch Panels/Control Panels

Overview

This section explains the basic function of selected switch panels found throughout the vessel along with helm controls used for stern drive gas/diesel or outboard power options.

Note that various components highlighted may not be installed on your vessel as they may be options or may be part of another propulsion package .

In addition, refer to your component owner's manual for more detailed information or contact your closest Regal dealer.

Helm Switch Panel-Lower



Sun Roof- This switch controls the FRP hardtop sun roof. When the switch is depressed an actuator opens the roof. Be sure to close the sun roof completely when leaving the vessel.

Nav/Anc- This on/off/on switch controls the navigation light system used for night cruising and mooring. Depress upper portion of switch to activate navigation lights split on each side of the deck and all running light. Depress lower portion of switch activates all around light for at sea night mooring only.

Fwd Bilge- This switch activates the forward bilge pump which is located under the floor accessible at the aft stateroom floor. Periodically pull up on the float and listen for the pump to verify it is working properly.

Aft Bilge- This switch activates the aft bilge pump which is located in the center bilge near the front of the engine. Periodically pull up on the float and listen for the pump to verify it is working properly.

Captain Seat- This switch activates the up and down movement of the driver's seat. It adjusts for individual heights of the operator.

Elect- This switch controls the dash mounted electronic components. Activate to operate VHF, GRID, and glass cockpit screens.

Panel Lights- This switch dims the instrument panel lights. Depress upper portion of switch to brighten panel lights; depress lower portion of switch to dim panel lights.

Windlass- This switch controls power to the windlass toggle switch panel located inside the forward starboard deck locker. This switch and the red on and off switch must be activated to operate the up and down deck foot petals.

Helm Switch Panel-Upper



Defrost- This switch controls power to the windshield blower/defroster unit. Note that windshield frost can develop in certain climatic areas and conditions. Operator must maintain clear visibility from the helm at all times.

Windshield Wiper/Washer- These switches control power to the port and starboard windshield wiper units as well as wash functions. Each switch features several intermittent delay intervals ranging from 3-18 seconds that control the wiper speed so you can set the wipers for most weather and water conditions.

Also, the switch features an LED night light indicator. There is a push-to-wash button on the top portion of the switch.

Horn- This toggle switch controls the deck mounted horn. Depress upper portion of switch and hold down to sound horn blast. Use horn for overtaking, emergency signaling and at attended bridge sites.

DC Breaker Panel Description- (Starboard Helm Locker)



Overview- *Note that this panel may contain breakers for components which may not be installed on your vessel.* This DC breaker panel protects many of the ship's components. Should a breaker "pop" find the cause of the overload before resetting the breaker. Reset the breaker by depressing it until it clicks in place.

To activate the plotter breakers push into place. To deactivate the breaker pull out.

HORN- This 15 amp breaker controls the deck mounted horn used for signaling.

SPOT LT- This 10 amp breaker controls the deck mounted search light.

TRIM TABS- This 20 amp breaker controls the trim tabs mounted at the hull transom area. Protects circuit wiring and pump from overloads.

NAV LTS- This 10 amp breaker controls the port and starboard deck mounted navigation lights and all-around light.

PANEL LTS- This 5 amp breaker controls the integrated helm lights.

ELECT/NMEA- This 15 amp breaker controls the NMEA (National Marine Electronics Association) 2000 backbone circuit which permits the electronic components to communicate with one another.

PLOTTER 1- This 7.5 amp push-pull breaker controls one of the helm mounted chart plotters.

VHF RADIO- This 10 amp breaker controls the helm mounted VHF marine radio with DSC mode.

BLOWER 1- This 15 amp breaker controls the engine blower located in the bilge.

DC Breaker Panel Description- (Continued)

BLOWER 2- This 15 amp breaker controls the 2nd engine blower in the bilge.

BILGE FWD- This 10 amp breaker controls the forward bilge pump located under the aft cabin access plate to the shower box.

BILGE AFT- This 10 amp breaker controls the aft bilge pump located in the aft center bilge.

WIPER PORT- This 15 amp breaker protects the port wiper motor and circuitry.

WIPER STBD- This 15 amp breaker protects the starboard wiper motor and circuitry.

WIPER PORT- This 15 amp breaker protects the port wiper motor and circuitry.

PLOTTER 2- This 7.5 amp push-pull breaker controls one of the helm mounted chart plotters.

RADAR- This 15 amp breaker controls closed array radar circuitry.

HELM SEAT F/A- Currently not used.

HELM SEAT U/D- This 10 amp breaker controls the helm seat up and down motor circuitry.

BATTERY PARALLEL- Currently not used.

WINDSHIELD DEFOG- This 15 amp breaker controls the windshield defroster blower component.

WINDLASS PERMIT- This 3 amp breaker controls the helm mounted windlass permit switch. This switch must be activated for the windlass to operate.

SUNROOF- This 10 amp breaker controls the salon hardtop sun roof motor circuitry.

VIDEO CAMERA 1- Currently not used.

VIDEO CAMERA 2- Currently not used.

DECK LTS- This 10 amp breaker controls the cockpit lights.

UNDER WTR LTS- This 15 amp breaker controls the transom mounted underwater light circuit.

HARD TOP LTS- This 5 amp breaker controls the hardtop/patio lights.

BILGE LTS- This 10 amp breaker controls the bilge engine light circuitry.

REFRIGERATOR- This 20 amp breaker controls the outside refrigerator.

USB/12V OUTLET- This 10 amp breaker controls the USB ports in the forward and aft staterooms.

AIS 600- Currently not used.

DEPTH MODULE- This 10 amp breaker protects the depth sounder transducer.

DC Breaker Panel Description- (Continued)

GAS VAPOR DETECTOR- This 3 amp breaker controls the gas vapor detector circuit. This system is not available on diesel models.

STEREO- This 10 amp fuse protects the stereo helm head unit circuitry. *Note that stereo amplifiers utilize their own breakers and or fuses.*

Note that there are 2 black plugs in the bottom row of the panel. Additional breakers for after market components could be installed here.

ACCY 1- This 10 amp breaker is normally saved for adding aftermarket accessories. On select models this breaker could actually be controlling a component.

ACCY 2- This 10 amp breaker is normally saved for adding aftermarket accessories. On select models this breaker could actually be controlling a component.

ACCY 3- This 10 amp breaker is normally saved for adding aftermarket accessories. On select models this breaker could actually be controlling a component.

HALON- This 3 amp breaker protects the helm mounted fixed fire extinguisher system circuit.

DC Distribution Center Description



Overview- The DC distribution is located in the bilge at the fire wall and is accessible thru the engine hatch. This breaker center controls select DC main ship system components and/or wiring circuits. *Note that select components listed may not be installed on your vessel.*

WINDLASS- This breaker controls the windlass system which is used with anchoring. It controls the wiring to the dash switch.

BLOWER MAIN- This breaker controls the engine and generator blowers.

AMPLIFIER- This breaker controls the Fusion entertainment system sound output.

ACCESSORY- This breaker controls any after-market components.

CABIN MAIN- This breaker controls the cabin component wiring and integrated components.

DASH MAIN- This breaker controls the helm wiring and all dash wired components except for select electronics.

DC Distribution Center Description (Continued)

ELECTRONICS- This breaker controls any helm mounted electronics including plotters and VHF marine radio.

SHOWER PUMP- This breaker controls the bilge pump located in the shower box accessible at the aft stateroom floor.

STEREO MEMORY- This breaker controls the Fusion circuitry pre-sets. This protection keeps any pre-selected stations and programs intact even though the main battery switches are "off".

FWD. BILGE PUMP- This breaker controls the forward bilge pump located near the shower box.

AFT BILGE PUMP- This breaker controls the aft bilge pump located at the front of the engine.

HIGH WATER ALARM- This breaker controls the high water dash alarm circuitry and components which are located in the bilge. Should the alarm sound at the dash stop the vessel and the engines, turn on the bilge pumps, and check the sump for water.

CABLE REEL- This breaker controls the shore power cable system and reel wiring.

HATCH LIFT- This breaker controls the aft hatch lift motor circuitry for bilge accessibility.

HALON- This breaker controls Halon fire extinguishing system including the helm mounted alarm.

OIL CHANGER- This breaker controls the engine oil changing system mounted in the bilge. Note that this system is not available on outboard vessels.

POWER PLATFORM- This breaker controls the aft mounted platform motor and circuitry available only with stern drive propulsion.

STEREO- This breaker controls the FUSION entertainment system circuitry.

Possible Problems-Solutions



1. It is possible that one of the battery distribution system breakers may trip from long-term arcing and heat. These thermal breakers function like other breakers but may reset different due to a “soft trip” condition. To trip and

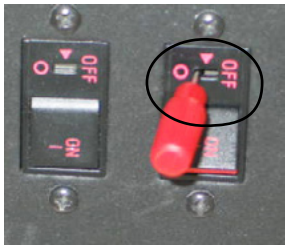

reset this style of breaker do the following:

A. Take a small slotted screwdriver from your on-board tool kit and insert it in the breaker slot until it trips. You will hear a snapping type noise. See the illustration.

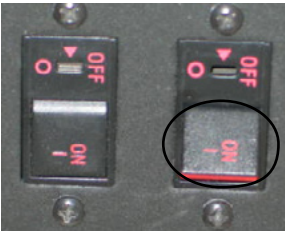

B. Notice that the breaker has pushed outward from its original flush position indicating the breaker has been tripped. See the illustration.

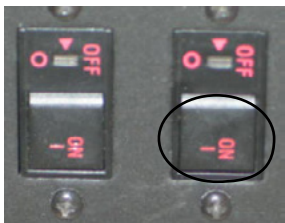

C. To reset the breaker use your finger to press the breaker down until it locks in the “on” position. You may hear a slight noise. This is normal. The icon light should be lighted after this procedure. See the illustration.

2. Breaker will not reset- Replace the breaker. Contact the nearest Regal yacht dealer for replacement parts.

3. Breaker continues to “trip”. Check the affected equipment to determine if it is responsible for the excessive draw to trip the breaker. If the equipment is determined to be within specifications check for a “short” in the wiring circuit. Also, the breaker may be faulty. Contact the nearest Regal yacht dealer.

Note: It is possible under certain circumstances that a breaker may preform a “soft” trip on a circuit. The breaker may not appear to be in the tripped position but at this point current to dedicated component or sub system is interrupted.

In this situation insert a screwdriver blade into the breaker slot (A) until it fully trips the breaker. After determining the cause of the overload energize the circuit breaker.

Galley Switch Panel

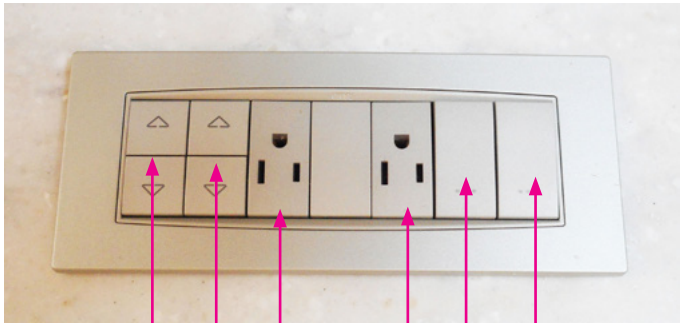

SALON TV UP
-DOWN

HALF WINDOW
UP-DOWN

120 VOLT OUTLET

INDIRECT CABIN
LIGHTING

* SELECT SWITCH FUNCTIONS MAY CHANGE

Cockpit (Patio) Switch Panel



ENGINE HATCH
UP-DOWN

COCKPIT TV
UP-DOWN

SUMP
LIGHTING

HARDTOP LED
LIGHTING

TRANSOM UNDER-
WATER LIGHTING

DECK
LIGHTING

Helm Seat Switch- Outboard

There is a switch panel for controlling the up and down movement of the driver's seat. It is located close to the driver's seat.

Volvo Glass Cockpit

If installed, the “Glass Cockpit” system on your vessel features a plotter integrating a single 16” screen. This system offers one stop shopping for full overviews of navigation and engine data. The Glass Cockpit monitors and controls all driver information including: navigation, engine data, and warning features in a single location.

The Glass Cockpit features:

- Multi-touch controls ie; (Pinch-to-Zoom)
- Both Blue Chart G2 and Lake Vu HD Maps
- 10 X per second position/heading refreshment
- View and control from smartphone or tablet
- Sleek flush mounting
- Integrated Glass Cockpit Owner’s Manual

Activating “Glass Cockpit” Plotter

To activate the Glass Cockpit plotter check the following:

1. Activate the “house” batteries from the battery management panel display located near the helm (Earlier BCM system) or 2 presses with e-key remote (Diesel). Outboards go to step 2.
2. Activate the electronic switch at the dash switch panel.
3. Energize the glass cockpit plotter power button at the top of the unit. Make sure power button is depressed long enough to power unit up.
4. For further information refer to the owner’s manual retrieval information on the next pages as it also will find the Glass Cockpit manual integrated in the plotter.

Volvo Glass Cockpit Displays (Typical)

Below shown are samples of displays available from the Glass Cockpit home screen. Go to A/V, Gauges, Controls and choose one of the views. Note that we have listed displays that may be found under each view.

Note that your vessel may not include a number of these displays.

Engine View

- Engine speed
- Engine hours
- Exhaust temperature, dry
- Coolant temperature
- Voltage
- Oil pressure
- Turbo pressure (Diesel)
- Transmission oil pressure
- Transmission oil temperature
- Load percent (Engine torque)
- Oil filter diff pressure

Vessel View

- Active corrosion protection information
- Depth with alarm
- Fuel level
- Fresh water
- Boat speed
- Power trim angle
- Rudder angle
- Water temperature

Battery View

- Voltage

Fuel Economy View

- Instant rate fuel
- Average fuel rate
- Time to empty
- Instant fuel economy
- Average fuel economy
- Trip fuel economy
- Distance to empty
- Fuel level
- Fuel Remaining

My View

- Boat speed
- Fuel level
- Fuel feed pressure
- Fresh water level
- Seawater temperature
- Seawater pressure
- Rudder angle
- Interceptor position
- Low speed mode, slip rate
- Propulsion speed
- Trip fuel
- Total fuel rate
- Trip distance
- Trip hours
- Total fuel economy

For further information refer to your Volvo engine or "Glass Cockpit" operator's manual.

Locating Owner's Manuals- Glass Cockpit Plotter

You can download the Regal owner's manual from the Regal web-site on to a SDHC card. When activated by the Glass Cockpit chart plotter the manual can be opened to the chapter/page desired and features touch control for page information magnification. Note that the process below may change as does the "Volvo Glass Cockpit" system.

To use the Regal owner's manual perform the following steps.:

1. Energize the chart plotter (power button) and wait for the home screen to appear.
2. After flipping up the cover, insert the SDHC card. Insert the Regal owner's manual card into one of the 2 slots at the lower right corner of the plotter.
3. Touch the INFO tab at the screen bottom.
4. Touch NEXT PAGE bar at the right screen area.
5. OWNER'S MANUAL bar will appear at the right screen area. Press owner's manual bar.
6. The Regal owner's manual title will appear as a main header bar along with the "Glass Cockpit" manual. Choose the Regal owner's manual.
7. Touch the OPEN bar at the right screen area. The Regal manual will open to the title page (first page).
8. Touch the MENU tab. Choose TABLE OF CONTENTS at the right side under Document Menu. Choose a chapter to open.
9. At this point touch GO TO in the right screen area and you will be taken to the first page of the chapter chosen. Then you can use the arrows to go forward or backward inside the chapter along with being able to change the size of the text (%).

Garmin “Grid” Remote Device



TYPICAL
“GRID”
REMOTE

This remote input device provides full control of single or dual chart plotter systems as installed on your vessel. Featured are a rotary knob and joystick control which provide navigation through various on board menus and screens including Fusion entertainment, navigation, auto pilot, sonar fish finder, radar, and others.

The “Grid” uses a NEMA 2000 network backbone thru a network cable to communicate with numerous devices.

In addition to the factory settings an individual can add new devices to the chart plotter and extend the existing system thru the “Active Captain App” and a mobile device.

For further information refer to the glass cockpit owner’s manual which can be downloaded on-line and printed. Also, this manual can be selected and viewed on the plotter screen per instructions on the previous pages.

Quick Start- Garmin “Grid” Remote Device

For basic functions follow the steps below to energize the grid device. Also, select buttons are noted.

1. Energize the boat battery system by using the battery panel (helm station).
2. Activate the helm electronics breaker.
3. Turn on the appropriate chart plotter(s) by activating their individual power button. Wait for the screens to display.
4. Power up the grid device by pressing the button on the top right face of the device. Grid device is now ready to use.

Button Tips:

Select Home from any screen to return to the Home screen.

Select Menu to open additional settings regarding that screen.

Select Menu to close the menu when finished.

Select Back to return to previous function.

Select STBY to engage auto pilot in standby mode. Green icon lites when auto pilot is engaged.

Select SOS to mark the location. See plotter owner’s manual for additional SOS type information.

Select + or - bottom grid buttons to magnify or to de-magnify screen size.

DC Current

Your Regal boat uses 12 volt DC electricity otherwise known as direct current. It is called DC because it flows only one way in a circuit. Specifically to name a few, gauges, batteries, battery cables, engine electrical components, engine wiring harnesses, dash switches, selected lighting, shower sump, bilge pumps, and vacuum toilets are all components that commonly use DC systems.

In the domestic DC system the red wire is designated as the “hot” or conductor wire and the black wire is referred to as the ground wire. At times other current carrying wires are color coded such as blue to identify their use as a low voltage conductor. This is especially helpful in troubleshooting and adding additional equipment. Be sure to review the wiring schematics in the drawing section of the technical chapter.

Direct current is stored in the ship’s batteries and produced through the engine stators or alternators while the engines are running or by the battery charger (if installed) at dock side. The engines charge the batteries by sending current produced by the alternators through the system to the appropriate battery. Normal DC voltage is between 12 and 15 volts. Lower or higher readings could indicate a charging malfunction or a battery problem.

Note that maximum current outboard stator output is 50 (5.3 L) and 70 (4.2 L) amps at wide open throttle and maximum current stern drive alternator output is 105 amps. The port engine battery controls the port engine and forward bilge pump. The starboard engine battery controls the starboard engine and high water alarm. The house battery controls a variety of onboard components and accessories. Another 8D house battery is found when the optional stabilizer (Seakeeper) is installed.

Fuses

Various fuses and fuse blocks onboard use both MIDI and ATC fuses. These style fuses are used frequently in the automotive industry.

MIDI fuses are used for system equipment components requiring high amperage protection including the toilet (head), cabin main, and Fusion stereo amplifiers.

MIDI fuses feature the following:

1. Use tin-coated copper blades for best conductivity and corrosion resistance.
2. Has a clear window for the fuse element to be seen easily. Helps in locating a “blown” fuse.
3. Specs for high amperage capacity which is great for many of the vessel DC devices.

ATC fuses feature the following:

1. They are fast acting so when activated they will blow faster causing less damage to components.
2. Are used as standard protection in auto/truck industry.
3. Tin-plated blades for corrosion protection.

Note that the fuses mentioned are available at marinas, retail boating outlets, automotive suppliers, and Regal dealers.

TYPICAL DC (12 VOLT) WIRING COLOR CODE & SIZES		
BLACK	16,14,12,10,8,6,4,2,2/0,40	GROUNDS
BLACK/WHITE	16	HALON INDICATOR
BLACK/YELLOW	10,16	GRD. DIESEL TRANSFER PUMP, MERC DIESEL STOP CIRCUIT
BLACK/WHITE	10	HALON MAIN GRD. FEED
BROWN/BLACK	10	MACERATOR, SUN ROOF
BROWN	10	SUN ROOF
BROWN	14	AFT BILGE PUMP-MANUAL
BROWN/WHITE	14	AFT BILGE PUMP-AUTO
BROWN/RED	14	FWD. BILGE PUMP-AUTO
BROWN/BLUE	14	FWD. BILGE PUMP-MANUAL
BROWN/PINK	16	CO DETECTOR
BROWN/BLACK	16	SHOWER SUMP PUMP
YELLOW	12,10	BLOWER
YELLOW/WHITE	16	HEAD VENT FAN MOTOR
YELLOW/BLACK	16	STEREO MEMORY
YELLOW/RED	14	ENGINE START CIRCUIT

Note: The list above applies to a number of domestic vessels. Vessel components/wiring specifications may vary depending on the vessel model and options aboard.

TYPICAL DC (12 VOLT) WIRING COLOR CODE & SIZES (CONTINUED)		
ORANGE	10,12	VACUUM TOILET, REFRIGERATOR, HATCH RAM
ORANGE	16	WIPER RUN
ORANGE/WHITE	16	WIPER PARK
ORANGE/BLACK	10,12,16	HORN, HATCH RAM
BLUE	14	INTERIOR LIGHTS, SWITCHED CIRCUIT
BLUE/RED	14	INTERIOR LIGHTS, CONSTANT HOT CIRCUIT
BLUE/BLACK	16	COCKPIT SOFT LIGHTS
BLUE/GREEN	16	INTERIOR SOFT LIGHTS
BLUE	10	CABIN LIGHT MAIN CIRCUIT FEED
GRAY	14	NAVIGATION LIGHTS, RUN- NING, BOW, TRANSOM LIGHTS
GRAY/BLACK	14	NAVIGATION LIGHTS, AFT ANCHOR, MASTHEAD
GRAY/WHITE	14	NAVIGATION LIGHTS, MAST- HEAD, FWD. RUNNING LIGHTS
RED	16	POSITIVE FEED- ELECTRON- ICS, GAS VAPOR DETECTOR, BREAKER TO DASH SWITCH FEEDS

Note: The list above applies to a number of domestic vessels. Vessel components/wiring may vary depending on the vessel model and options aboard.

TYPICAL DC (12 VOLT) WIRING COLOR CODE & SIZES (CONTINUED)		
RED/WHITE	16	WINDLASS CONTROL-DOWN
RED/BLACK	16	WINDLASS CONTROL-UP
RED/WHITE	14	BATTERY PARALLEL-LOAD
RED	14	POSITIVE FEED-ELECTRONICS
RED	12	POSITIVE FEED-ELECTRONICS
RED	10	POSITIVE FEED-AUTO PILOT
RED/VIOLET	10	FUEL TANK TRANSFER PUMP AMPLIFIER POWER
RED	8	POSITIVE FEED- MAIN ALTERNATOR CHARGE
RED	6	POSITIVE FEED- MAIN ALTERNATOR CHARGE
RED	4	POSITIVE FEED-MAIN
RED	2	POSITIVE FEED- MAIN STARTER, BATTERY, GENERATOR
RED	2/0	POSITIVE FEED- MAIN, START- ER, BATTERY
PURPLE	16	STBD. IGNITION, HOUR METER- WINDSHIELD VENT
PURPLE/WHITE	16	PORT IGNITION, HOUR METER, WINDSHIELD VENT
PINK	16	STBD. FUEL TANK SENDER
PINK/BLACK	16	PORT FUEL TANK SENDER
TAN/BLUE	16	ENGINE ALARM CIRCUIT
GREEN	16	TANK LEVEL MONITOR, SPOT- LIGHT
GREEN	10	SPOTLIGHT
GREEN	8	BONDING

Note: The list above applies to a number of domestic vessels. Vessel components/wiring may vary depending on the vessel model and options aboard.

Batteries

All vessel DC equipment and specifications are subject to change at any time, as part of Regal's commitment to product improvement. Note that the stern drive vessel uses a specific battery management panel consisting of a series of remote automatic battery switches and ACR charging units.

Battery Terminology Descriptions

Group- Batteries are divided into groups which identify the height, length, and width of the battery. This is useful information should a replacement battery become necessary.

Cold Cranking Amps (CCA)- This rating measures the cranking power of a full charged marine battery having the ability to start at 32 degrees F. Basically, the higher the rating the greater starting power of the battery.

Reserve Capacity (RC)- As usage on the boat increases so does the need for more reserve capacity. The reserve capacity represents the length of time in minutes a new fully charged battery can maintain the vessel's electrical needs without the engine running.

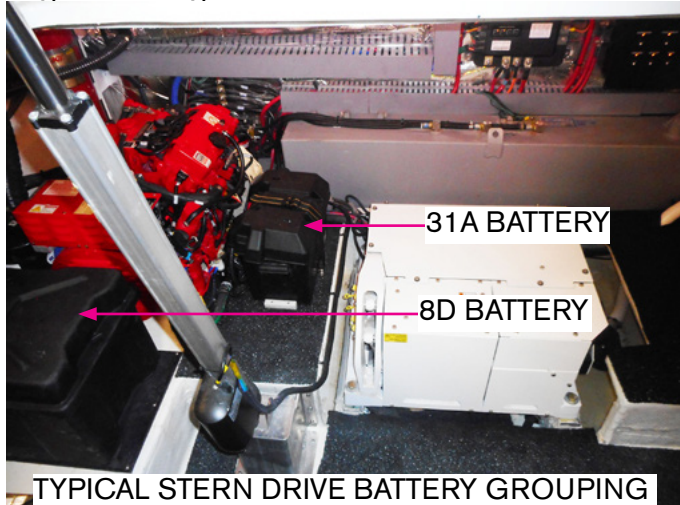

Note that the 38XO outboard vessel currently uses three 31 A series cranking batteries one for each engine. They feature wet cells and vent hydrogen gas through the top caps. As they are found in the bilge inside a vented battery box care must be taken to ensure ignition protection is followed at all times to prevent an explosion from hydrogen gas.

Never use power tools, wet-dry vacuums or any type of component in the bilge that contain brushes as they give off sparks rotating around an armature when in use. Vent the bilge by opening all hatches and energizing the blower (with generator option).

Below are the basic battery specifications of Group 31 A batteries (engine cranking type).

BATTERY SPECIFICATIONS			
Battery Type	Group	CCA @32 Degrees F.	Reserve Capacity
Engine Cranking	31 A	1200	185 min.

Your vessel uses an 8 D deep cycle house battery to provide power to heavy duty DC user components that may be on board such as the windlass, toilet, and various motor driven components such as a power platform. The optional Seakeeper adds a 2nd 8 D battery to the vessel.

Below are the basic battery specifications of Group 8 D batteries (deep cycle).

BATTERY SPECIFICATIONS			
Battery Type	Group	CCA @32 Degrees F.	Reserve Capacity
House	8 D	1400	430 min.

Battery Problems/Solutions



1. Weak battery- This battery problem can be caused by low electrolyte cell levels. Warm, bilge/ sump compartment temperatures will deteriorate a battery's life quicker by evaporating the water from the electrolyte, thus corroding and weakening the positive grids inside the battery. With the house battery low electrolyte levels can be monitored by periodic inspection and filling as needed with distilled water. Boaters in higher climate areas with longer stretches of hot weather will need to check their batteries more often.

The engine cranking batteries require distilled water periodically. They do feature a different chemistry that does consume less water. Inside the cells as gases are released condensation is formed which aids in maintaining the cell electrolyte level. These batteries incorporate a deeper layer of electrolyte over the plates, but eventually it can run dry. On the 31 series engine cranking batteries keep all terminals clean, connections tight and your electrical system in top shape to extend battery life.

2. Dead Battery- Either the battery will not accept a charge, hold a charge or the charging system is not supplying current flow through the battery charging system and/or engine stators.

The battery charger output can be checked by monitoring the lights on the charger front face.

To begin check all battery post connections for tightness and corrosion.

With the engines running the displayed voltage of the port, center, or starboard engine battery and house battery should be between 12.5 up to 14.6 volts.

If less than 12 volts check for voltage across the battery terminals.

If less than 12 volts on the house battery use a hydrometer to locate faulty cells in a flooded type battery.

On maintenance free batteries they can be removed from the vessel if necessary and trickle charged. If readings after charging are low replace the battery.

TYPICAL OUTBOARD BATTERY LOCATIONS

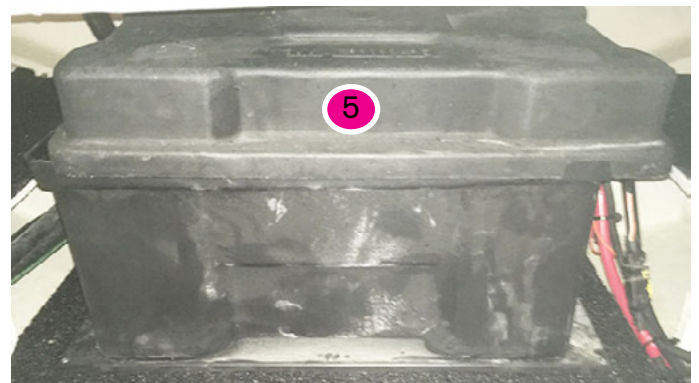
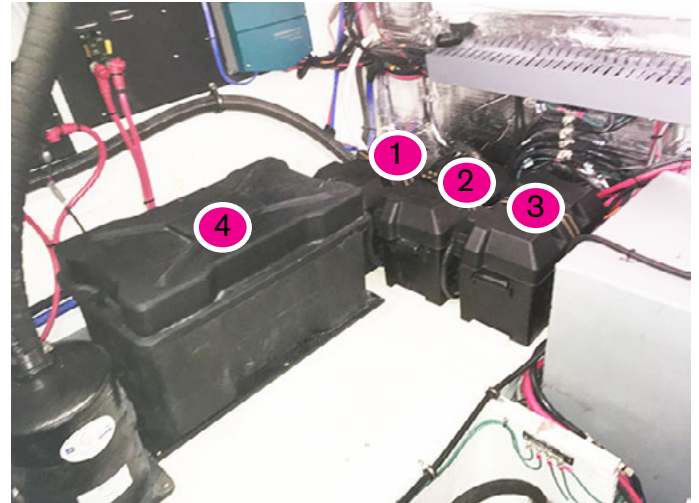

SEAKEEPER HOUSE BATTERY-UNDER MOTOR WELL

Typical outboard battery group identification as follows (Note that locations subject to change):

1. Port engine starting battery.
2. Center engine starting battery.
3. Starboard engine starting battery.
4. House battery.
5. House battery- (Seakeeper option) Stabilizer.

Battery Management System- Earlier

Introduction

The **earlier** battery management system is an electronic system of interactive related components that uniquely control, monitor, and manage the DC boat battery power supply. The system ensures that an exceptional amount of direct current is available for the engines and all onboard components. This system versatility lends itself to gas, diesel, and outboard propulsion as offered on this vessel.

The earlier battery system is *recognized* and can be controlled from the BCM (Battery Control Module) by using the BCM keypad control, the remote e-key sender, or the battery management display located near the helm. *See next page photo of BCM found in the bilge on these earlier vessels.*

General information is addressed in this chapter and may apply to all propulsion options on this vessel. Typical system schematics are found in the technical chapter.

More specific concerns can be directed to your closest Regal yacht dealer or found in the owner's information packet and in the engine manufacturer's operator's manual.

Note that all system specifications, dimensions, locations, and components are subject to change at any time as a part of Regal's quality and product improvement programs.

Note that this earlier battery management system described here was used on the first 3 vessels only.

Battery Management System Parts Description

1. BCM (Battery Control Module)
2. Battery sensor
3. Battery management display unit
4. E-key remote sender/E-key remote receiver

1. The battery control module (BCM) is the brain box of the battery management system. Regal uses one BCM per engine. This number satisfies the battery needs according to the various components downstream that use the available DC amperage. Normally the BCM is found on the engine fire wall bulkhead. See more detailed information on the following pages.

2. The battery sensor monitors each batteries voltage, amperage, charge and general battery status. The sensor is connected to the negative post of each battery.

3. The battery management display unit is used to control each battery along with battery information. Also, it controls the BCM switching functions. See the following pages for more detailed switching functions. The display unit is mounted at the helm area.

4. The e-key remote sender unlocks/locks the vessel's electrical system and turns on the engine's ignition through the e-key remote receiver. See the following pages for more e-key detailed information. Also, additional information may be found in the engine operator's manual. The receiver is mounted behind the aft stateroom television screen on the bulkhead.

Battery Management Components-Earlier

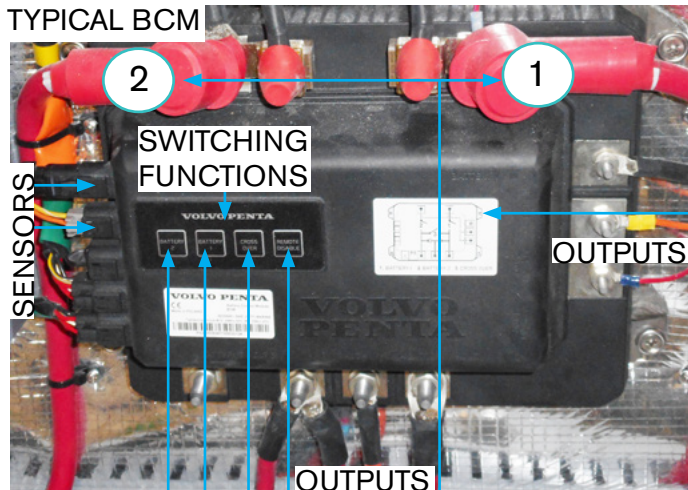

BATTERY 2
 BATTERY 1
 CROSS OVER
 REMOTE DISABLE
 TO HOUSE-ENGINE BATTERY

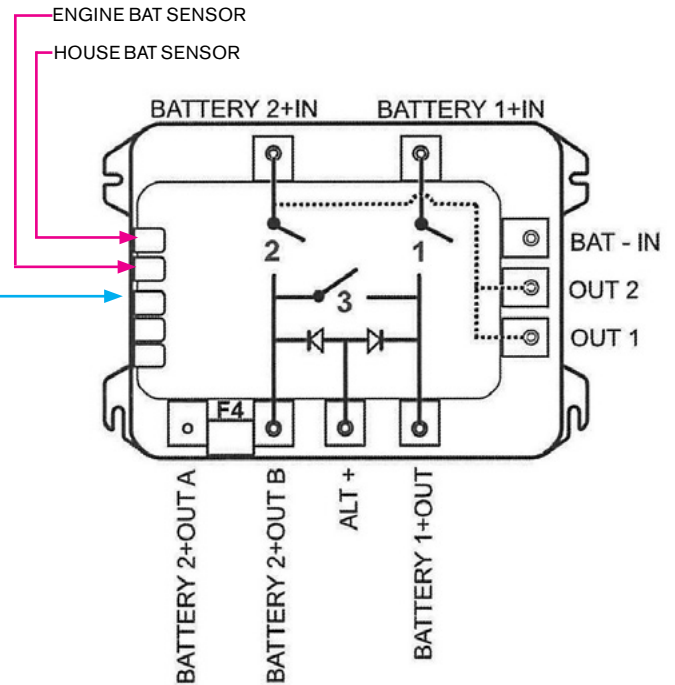

The **switching functions** on the BCM keypad control **can be remotely activated by depressing the function button to control boat battery systems/components downstream as follows:**

BCM-Earlier

As a reference point there is usually 1 Volvo BCM per stern drive engine. Therefore, Regal uses 2 BCM's for twin stern drive engines. Two BCM's are used along with a battery switch for 3 outboards.

The number of BCM's adequately covers all power consumers on board.

Note that battery 2 switching function is connected to a house battery on each BCM (never connect switch 2 to an engine cranking battery).

Note that #2 at the top of the BCM is an input connection from a house battery.

#1 at the top of the BCM is an input connection from an engine cranking battery.

Sensors from each battery negative terminal are plugged into the sensor input as shown. Never change the sensor plug in sequence on the BCM. Only 2 battery sensors can be attached to each BCM.

Battery 1- Activates or deactivates the power supply for starting the engine or components at the output side. Battery 1 effects the cranking battery.

Battery 2- Activates or deactivates the power supply to a house battery or devices at the output side.

Crossover- Activates and connects 2 batteries (switches 1 and 2) for emergency starting due to a weak battery.

Remote disable- This switching function is used to deactivate the power when working on the boat's electrical system. This process will deactivate power to the main breaker panel and e-key remote. Remote deactivation affects all BCM's in the system. Breakers can still be locally controlled through the other BCM function switches.

Battery Sensor-**Earlier**

The battery sensor monitors battery functions such as amperage, voltage, status and charge %. The data measured levels are shown on the battery management panel display near the helm.

Up to 2 battery sensors can be attached to the BS 1 and BS 2 inputs located on the BCM (shown as sensors on the BCM photo). Always connect house battery to BS 2.

Note that the battery sensor is installed on the negative post of each battery.

Battery data readings need to be read continuously to be reliable. Do not disconnect the sensor from the battery except to change out a battery.

Battery Management Panel Display- **Earlier**

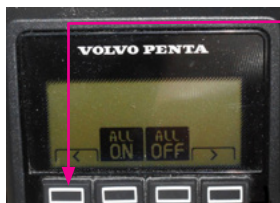

Use buttons to scroll through the default menus.

The battery management panel shows battery status, BCM switching functions

and warning messages. You can set button operations for the e-key remote and panel buttons. Warning messages are shown on this panel. During standby mode or start the display shows the last view.

Use the arrows to scroll through the menus. Note that “ALL ON” means that all batteries are energized (both house and engine cranking batteries). “ALL OFF” means all batteries are de-energized (both house and engine cranking batteries).

By scrolling you can find each battery, display its condition, specifications with a pictograph, and control each battery,

Use the backward arrow to return to previous menus and “OK” to proceed through various menus and confirm selections.

E-Key Remote Sender- **Earlier**



In addition to the battery management panel and the BCM switches the e-key remote sender is another option for locking and unlocking the boat's battery system along with

the ability to activate the boat's ignition system through the e-key remote receiver.

In addition, the e-key uses two buttons to control selected vessel lighting systems. Factory settings are as follows: Button # 1 controls the deck lighting. Button # 2 controls the patio lighting. This is a great feature when boarding or leaving the vessel.

The “on” and “off” buttons control the port, starboard ignition and battery systems. Pressing the “on remote button **once** will activate all. Pressing the “off” remote button **once** will deactivate all.

These functions will show up on the battery management panel located at the helm. See your Volvo engine operator's manual for additional information.

Pressing the “on” button **twice** will activate the house batteries only.

It is a good idea to keep extra batteries on hand for the E-key (#2032). This is a round lithium battery type,

Note that the e-key remote system is not available with Yamaha outboards.

Battery Management System (Stern Drive- Later)

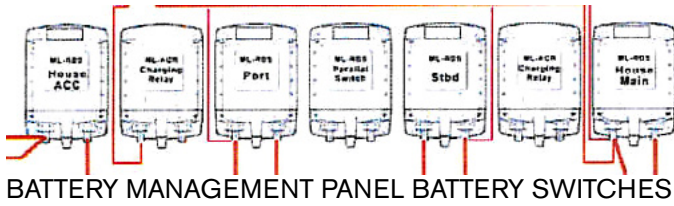

The battery management panel (shown above) is used on stern drive vessels and features a set of remote battery switches which are connected through the battery activation panel. When activated by the battery activation switches individual engine cranking and house battery functions are energized. Also, battery parallel circuits are connected as the parallel buttons are activated on the battery activation panel. Notice on the above drawing both ACR's (automatic charging relays) and a parallel switch are key players in the battery charging process.

Located on the bottom of remote battery switches are switch link plates which connect battery switches and assist in charging current bleeding through to all connected battery circuits.

The remote battery switch circuits are charged by the engine alternator system when the engines are running and by the battery charger when a shore power cord is connected from the vessel shore power inlet to a marina shore power supply center. Remember that a remote battery automatic switch must be in the remote position to be operational. Refer to the battery management system drawing on the previous page when troubleshooting the system.

Note that center battery is used only on triple outboard vessels. Also, there are various differences between the stern drive and outboard panel components and operation. Refer to the correct drawings and operations for each.



Battery Activation Panel (Earlier)- Operation

Earlier Panels- Each button displays a continuous blue ring *when power is available to that button function.*

When a button is depressed to activate a switch the blue lit ring changes to a red ring indicating that current is flowing through the entire circuit. *For example, when the stbd. battery button is depressed the lit blue ring changes to red indicating the starboard engine battery circuit is engaged and it is ready for starting the starboard engine. In the course of depressing the button a magnetic induction process at the starboard automatic battery switch (located in the sump on the battery management panel) occurs due to current in the circuit pulling a magnetic latch down and holding the automatic battery switch in a closed position. This permits starboard engine battery availability to start starboard engine.*

Battery Activation Panel (Later)- Operation

Later Panels- Each button displays a continuous color *only when the button is depressed.*

When a battery switch is depressed the switch will emit a blue color.

When a parallel switch is depressed the switch will emit a red color.

Macerator- This switch as shown on the previous page in a normal “off” position displays no colored ring. When the overboard discharge pump (macerator) key switch is turned to the “on” position at the ship’s main DC panel the battery activation panel button labeled macerator will show the blue lighted ring **only on earlier battery activation panels.**

Remember that pumping waste overboard requires a 2 step process. After the key switch is turned to the “on” position the macerator button at the battery activation panel can be depressed to start the waste pumping process.

While the macerator pump is cycling the macerator panel button will display red.

Battery Activation Panel- Button Functions

Port Battery- This switch when depressed completes a circuit to the port engine battery through the port automatic battery switch on the battery board. This permits port engine starting.

Center Battery- (Triple outboard vessels only). This switch is plugged on earlier panels and **non-existent on later twin stern drive battery activation panels.**

Stbd. Battery- This switch when depressed completes a circuit to the starboard engine battery through the starboard automatic battery switch. This permits the starboard engine to be started.

Note that the engine battery type is a group A-31.

House Battery- This switch when depressed completes a circuit to the house batteries which includes both the house main and house accessory units. Current runs through both the house and house accessory automatic battery switches.
Note that both house batteries are group 8-D.

Read and understand the following label regarding using the battery parallel functions on the battery activation panel.

<h1 style="margin: 0;">NOTICE</h1>
<p>THE BATTERY PARALLEL FEATURES ON THIS VESSEL ARE INTENDED FOR EMERGENCY INTERMITTENT USE ONLY! WHEN A PARALLEL FEATURE IS REQUIRED IT MAY INDICATE A SERVICE BATTERY IS NEAR THE END OF ITS USEFUL SERVICE LIFE.</p>

Engine Parallel- This switch when depressed will parallel (combine) the port engine battery to the starboard engine battery for emergency intermittent use.

House Parallel- This switch when depressed will parallel (combine) the “house main” battery to the starboard engine battery.

In addition, it will parallel the “house accessory battery” to the port engine battery for emergency intermittent use.

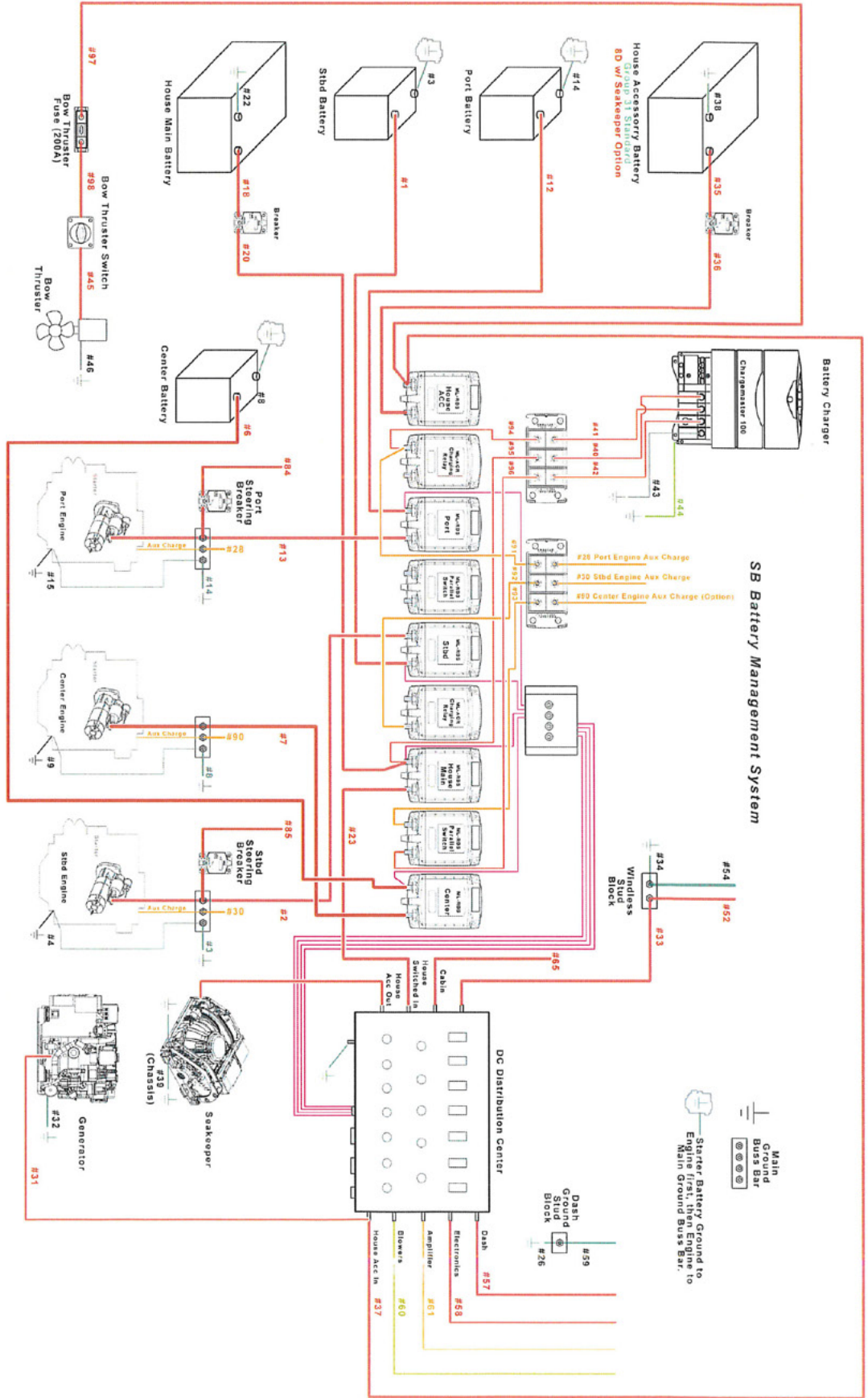

Note: your outboard (SB) battery management panel may vary from drawing

Battery Management System (Outboard- Later)

The battery management panel (shown on previous page schematic) is used on outboard vessels and features a set of remote battery switches which are connected through the battery activation panel.

When activated by the battery activation switches individual engine cranking and house battery functions are energized. Also, battery parallel circuits are connected as the parallel buttons are activated on the battery activation panel. Notice on the drawing both ACR's (automatic charging relays) and a parallel switch are key players in the battery charging process.

Note that the system includes Aux. charge wiring from each outboard. Also, there may be steering system breakers fed by the Aux. charge system.

Located on the bottom of remote battery switches are switch link plates which connect battery switches and assist in charging current bleeding through to all connected battery circuits.

The remote battery switch circuits are charged by the outboard engine stator system when the engines are running and by the battery charger when a shore power cord is connected from the vessel shore power inlet to a marina shore power supply center.

Remember that a remote automatic battery switch must be in the remote position to be operational.

There are various differences between the stern drive and outboard battery management panel components and operation. Refer to the correct drawings and operations for each.



Battery Activation Panel (Earlier)- Operation

Earlier Panels- Each button displays a continuous blue ring *when power is available to that button function.*

When a button is depressed to activate a switch the blue lit ring changes to a red ring indicating that current is flowing through the entire circuit. *For example, when the stbd. battery button is depressed the lit blue ring changes to red indicating the starboard engine battery circuit is engaged and it is ready for starting the starboard engine. In the course of depressing the button a magnetic induction process at the starboard automatic battery switch (located in the sump on the battery management panel) occurs due to current in the circuit pulling a magnetic latch down and holding the automatic battery switch in a closed position. This permits starboard engine battery availability to start starboard engine.*

Battery Activation Panel (Later)- Operation

Later Panels- Each button displays a continuous color *only when the button is depressed.*

When a battery switch is depressed the switch will emit a blue color.

When a parallel switch is depressed the switch will emit a red color.

Macerator- This switch as shown on the previous page in a normal “off” position displays no colored ring. When the overboard discharge pump (macerator) key switch is turned to the “on” position at the ship’s main DC panel the battery activation panel button labeled macerator will show the blue lighted ring **only on earlier battery activation panels.**

Remember that pumping waste overboard requires a 2 step process. After the key switch is turned to the “on” position the macerator button at the battery activation panel can be depressed to start the waste pumping process.

While the macerator pump is cycling the macerator panel button will display red.

Battery Activation Panel- Button Functions

Port Battery- This switch when depressed completes a circuit to the port engine battery through the port automatic battery switch on the battery management panel. This permits port engine starting operations.

Center Battery- (Triple outboard vessels only). This switch when depressed completes a circuit to the center engine battery through the center automatic battery switch on the battery management panel. This permits center engine starting operations.

Stbd. Battery- This switch when depressed completes a circuit to the starboard engine battery through the starboard automatic battery switch. This permits starboard engine starting operations.
Note that the engine battery type is a group A-31.

House Battery- This switch when depressed completes a circuit to the house batteries which includes both the house main and house accessory units. Current runs through both the house and house accessory automatic battery switches.
Note that both house batteries are group 8-D.

Read and understand the following label regarding using the battery parallel functions on the battery activation panel.

<h1>NOTICE</h1>
<p>THE BATTERY PARALLEL FEATURES ON THIS VESSEL ARE INTENDED FOR EMERGENCY INTERMITTENT USE ONLY! WHEN A PARALLEL FEATURE IS REQUIRED IT MAY INDICATE A SERVICE BATTERY IS NEAR THE END OF ITS USEFUL SERVICE LIFE.</p>

Engine Parallel- This switch when depressed will parallel (combine) the port engine battery to the starboard engine battery. In addition, it will parallel the center engine battery to the house main battery for emergency intermittent use.

House Parallel- This switch when depressed will parallel (combine) the “house main” battery to the starboard engine battery.
In addition, it will parallel the “house accessory battery” to the port engine battery for emergency intermittent use.

Remote Battery Switch Operation

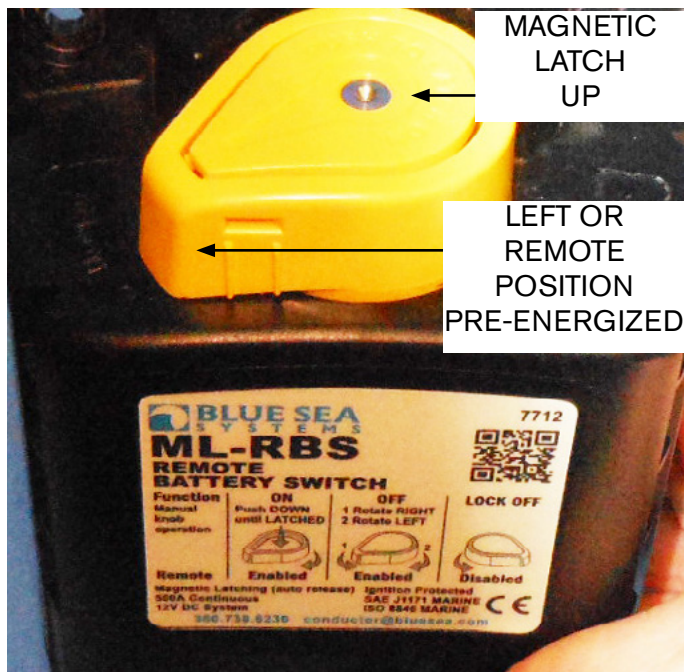

1. Normal operation of the remote battery switch is completely to the left in the auto or “remote” position. Notice latch position is up (manually disengaged). To energize the house circuit press the appropriate switch at the battery activation panel. Once the switch is energized the magnetic latch will be pulled down in the energized position.

2. If the remote battery system fails for some reason the skipper can override the remote battery switch manually through the magnetic latch which is located on top of the switch. Just turn the switch to the left and push the magnetic latch down until it engages.

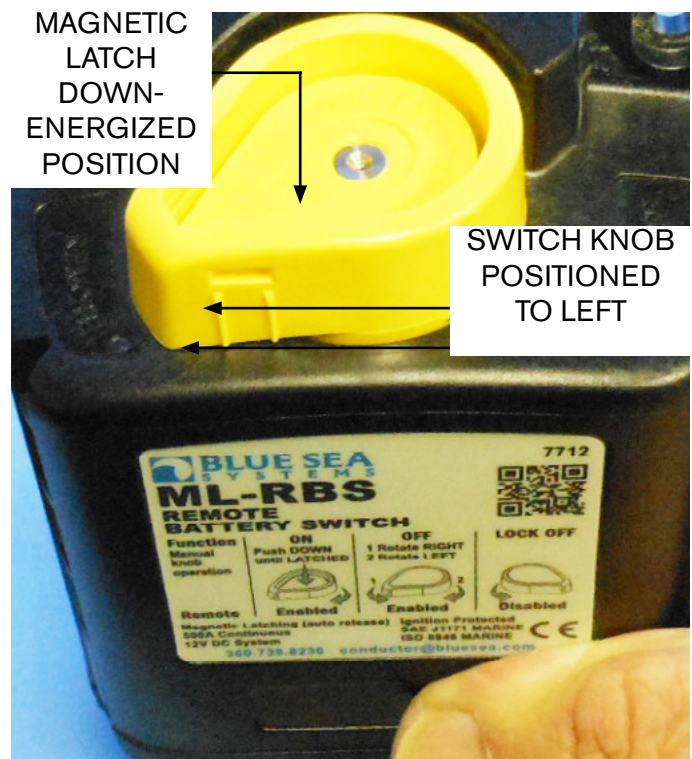

3. In the event of servicing the house battery components turn the remote battery switch to the right (Lock or Off Position). Pass a tie wrap through hole to secure the remote battery switch knob until servicing is complete.

Remote Battery Switches, Charging Functions & Battery Management

If a remote battery switch is positioned as shown below (straight out, OFF position) that particular battery or connected battery bank will be **inoperative**. This positioning could effect both starting and house battery circuitry. After sump maintenance or electrical repairs always check the battery switches to ensure switches are in “on” remote position.



2. When operating the optional Seakeeper (stabilizer) make sure to run generator to charge the house accessory battery.

3. Periodically check all battery hardware for tightness and ensure battery electrolyte is up to required cell levels. Use only distilled water for filling lead acid types of batteries. Wear proper eye wear and gloves when servicing battery systems. Read the maintenance chapter for more information.

4. Periodically check all battery bank hardware for tightness and corrosion. Maintain as needed.

5. **Always turn off the battery switches at the battery activation panel before leaving vessel.**

6. For safety sake, charge all batteries outside of the vessel to eliminate possible hydrogen gas build-up in the sump and sparks from battery charger/leads.

Typical Battery Charger

The standard battery charger features 50 amp output and universal voltage for multiple battery circuits.

The charger operates between 95 and 277 volts.

This is helpful on docks that carry lower voltage. The new electronic battery chargers are “smart”. They will charge the batteries in 3 stages; bulk, absorption, and float formats. The charger is designated to get the maximum life out of your batteries, using micro computer controlled charging.

It is recommended to keep the battery charger “on” at all times when AC power is available for maximum battery life.

We recommend checking battery water levels weekly. Fill batteries to specified levels using only distilled water. The charger is factory set to charge flooded lead acid batteries which are the most common type available. The charger can be reprogrammed to accept gel cell or AGM batteries.

In the event the boat is switched over to different battery designs, it is important that all batteries are of the same type.

Note on vessels with optional Seakeeper aboard the battery charger increases to 100 amps along with another 8-D house battery to support electrical demands of Seakeeper stabilizer.

Remember, changing to a different battery type requires re-programming the charger. Do not mix different designed batteries because they need different charging rates and voltages.

During bulk charge the battery charger brings up the battery charge state quickly, as the battery nears fully charged, it switches over to absorption charge. Absorption charges at a lower rate than bulk, until the battery is just a few % away from full charge.

The battery charger display includes functional LED information for charge current, charge voltage, charge phase (bulk, absorption, float), battery content measurement and/or battery condition measurement as a % of Ah capacity.

It is recommended that an ABYC certified electrical technician perform any repairs or service. Do not attempt to open the battery charger casing.

Refer to the vendor information for far more detailed instructions and the illustration on the following page.



WARNING

PREVENT INJURY, DEATH, AND/OR
PROPERTY DAMAGE FROM HIGH VOLTAGE!
DISCONNECT THE AC POWER SUPPLY
BEFORE ATTEMPTING TO BEGIN ANY BATTERY
CHARGER SERVICE WORK.

Standard Battery Charger Layout & Notes

NOTE THAT LOCATIONS/COMPONENTS MAY VARY

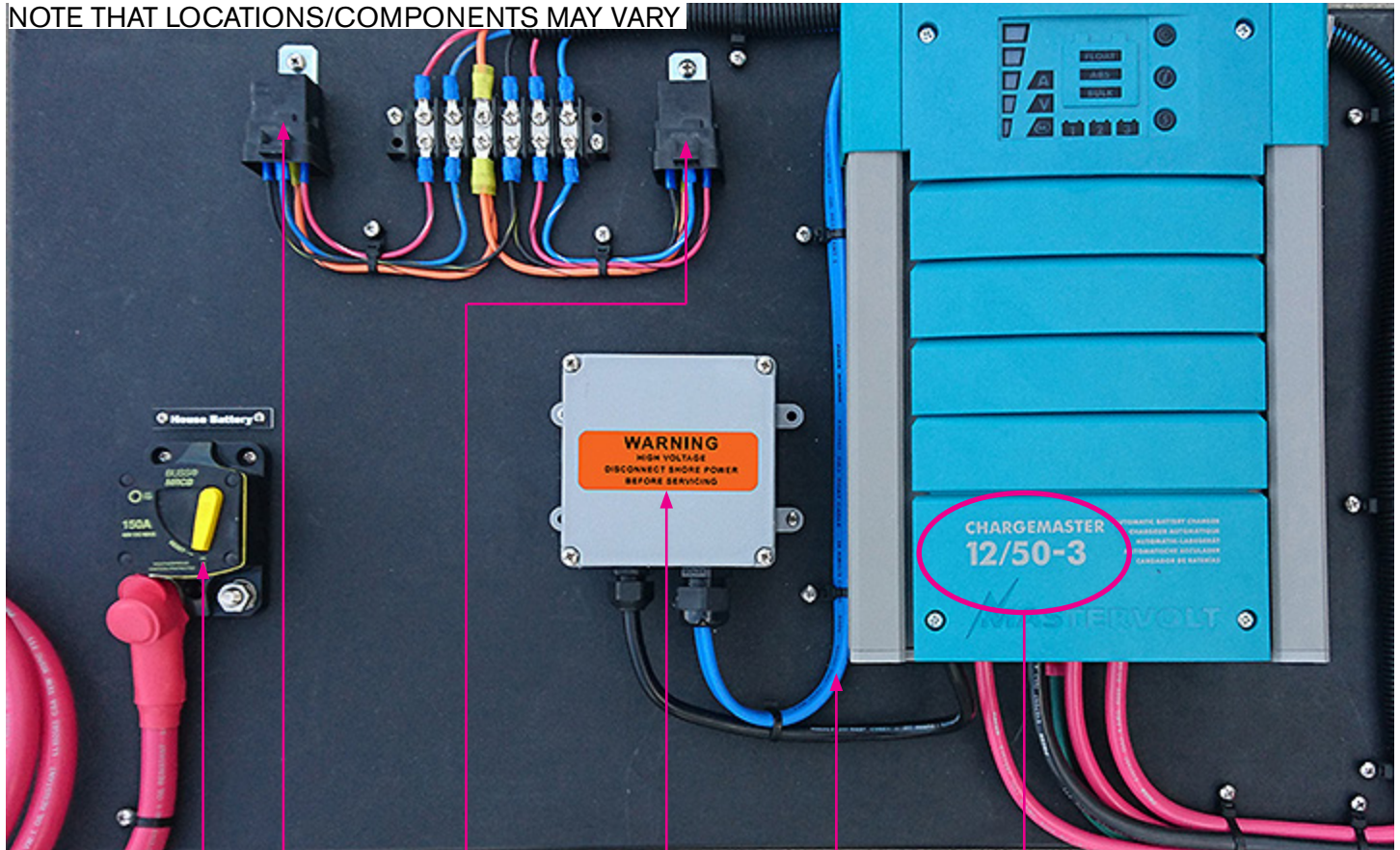

150 AMP HOUSE BATTERY BREAKER

PATIO LIGHTS RELAY E-KEY REMOTE

50 AMP STANDARD BATTERY CHARGER

DECK LIGHTS RELAY E-KEY REMOTE

BATTERY CHARGER JUNCTION BOX- SEE 240 VOLT WARNING

TO BATTERY CHARGER BREAKER MAIN SHIP'S AC PANEL

The red wire from the battery charger breaker runs to the hot (positive) side of the group 8D house battery. If the breaker blows after determining the cause of the problem slide the handle up to the "on" position to reactivate the breaker. Periodically check all fasteners on the breaker and the battery for tightness. Reinstall any boots on the positive stud.

Note that a 2nd 150 amp breaker is added when the Seakeeper option is installed on board.

Read and understand the following 240 volt warning below as noted on the battery charger junction box:

WARNING

PREVENT INJURY, DEATH, AND/OR PROPERTY DAMAGE FROM HIGH VOLTAGE!
DISCONNECT SHORE POWER BEFORE SERVICING!

Typical Battery Charging Summary-Earlier

Following are a few notes regarding the charging system or specific charging system components.

1. With the battery charger unplugged from shore power the battery charger is not generating any DC power. However, the battery charger is connected to the batteries through the BCM's and 10 amp charger breaker which is located on the 240 volt ship's main AC panel. The charger breaker would blow if there was a short in the wires that run directly to the battery charger.

A primary cause of the breaker to "trip" would be if the positive and negative battery cables were reversed. The above situation could easily happen if someone was trying to "jump start" an engine with "jumper cables".

To a lesser degree should a wire delivering current from the battery charger chafe an internal fuse may "blow" and the battery charger would cease its charging operation. See your Regal dealer to order extra fuses for your charger.

3. If on the water and one of the engine cranking batteries is weak or "dead" and the engine will not crank first start the generator and let it run awhile as it will send an initial charge to the weak battery. Another option is to energize the crossover battery feature.

4. Always deactivate the ship's main AC/DC breakers when leaving the vessel for extended periods. Select breakers that control specific safety functions of the boat will operate as normal even with the battery management panel off such as the automatic bilge pumps and stereo memory circuits.

5. When leaving the vessel after connecting your dock side power cord turn the battery charger breaker at the ship's management panel to the "on" position. This will permit the battery charging system to energize the appropriate batteries as needed.

6. Always remove a battery from the bilge before using a trickle charger.

7. It is not recommended to jump start engines using booster or jumper cables as these cables can produce sparks in the bilge while hooking or unhooking them. Sparks could cause an explosion or fire in the bilge.



CAUTION

AVOID CHARGING SYSTEM DAMAGE
DUE TO REVERSED BATTERY CABLES!
REMEMBER RED TO POSITIVE AND BLACK
TO NEGATIVE WHEN CONNECTING
BATTERY CABLES.

AC Current

Overview

Alternating current sometimes called AC current is brought on board through the use of a dock-side (shore power) cord or produced on board through the generator. Just as a residential home uses 120/240 volts to run various household appliances and equipment the same holds true on your vessel.

With AC current electrons “cycle” in one direction a short distance and reverse themselves traveling in the opposite direction. This is how AC became known as alternating current. The rate that the current reverses itself is referred to as frequency. In the United States the alternating current frequency is 60 cycles per second. Overseas a 50 cycle frequency per second is standard. Component specifications must match the country's frequency.

Basic Electric Terms

Voltage is a measurement of the electrical potential that an electrical power source contains for doing some type of work for us. Think of it as electrical pressure. An example might be your boat's battery.

Amperage is a particular amount of electricity flowing through some part of a circuit. Think of it as the rate of electrical flow through your boat's wiring.

Resistance is measured in ohms and inhibits the electrical flow through a circuit. An example would possibly be an incandescent light bulb. The resistance in the light bulb element allows it to glow and brighten the cabin along with giving off heat.

It is important that you understand and respect the alternating current system used on board. **Be sure to read and follow any danger, warning, or caution labels in reference to the yacht's electrical system or individual equipment components.** Most of all, use common sense around electrical components!

Dock Side Cord Usage

The dock side cord is the basic component used to deliver 50 amp service from the marina dock power box to the vessel itself. Before plugging in the dock side power cord check to see that all vessel AC breakers are off. This includes the incoming as well as both the main and equipment breakers at the AC ship's control panel.

The cord reel breaker must be activated. Pull sufficient cord out of the cord reel. When connecting the shore power cord be sure to twist the cord into the marina inlet 50 amp plug. This motion will lock the plug in the socket.

There may be several types of inlet plugs located at the marina dock power center. A 50 amp cord will not physically fit into a smaller (30) amp receptacle. Also, marina dock power centers normally have breakers that must be activated after installing the dock side cord. Make sure the dock side cord has enough slack to weather changing tides if applicable and at the same time does not come in contact with the water. Check with the marina dock master for more information on their shore power operation and requirements.

Note that before attempting to disconnect the shore power cord turn off all equipment and main AC breakers on the ship's main AC panel to prevent component/ system damage.

Dock Side Cord Usage- Continued

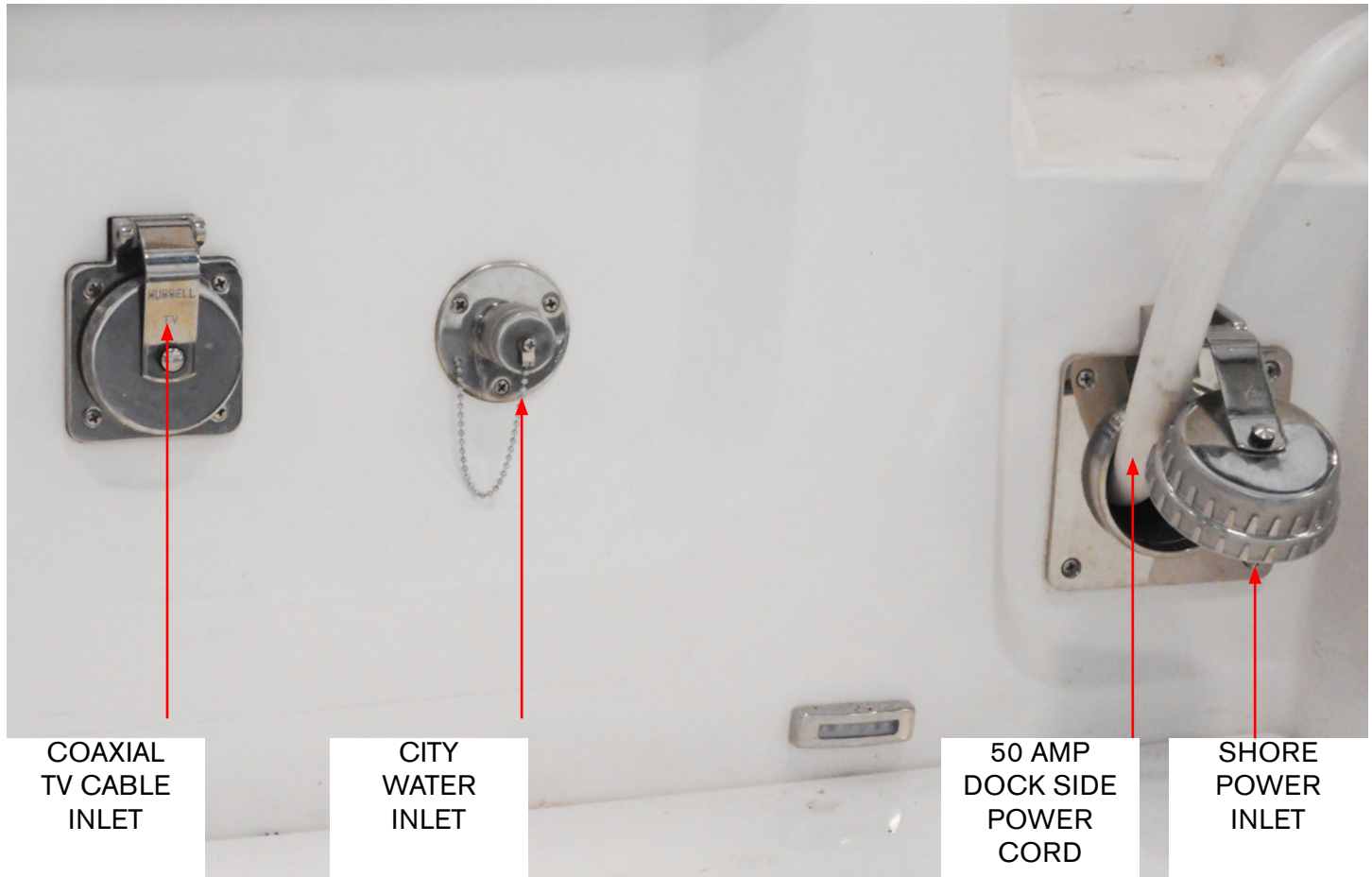

Overview

Typical 50 amp domestic shore power cords (dock side cords) including your shore cord reel contain four wires:

Red-ungrounded conductor containing 120 volts
Black-ungrounded conductor containing 120 volts
White-neutral ungrounded conductor
Green-grounding conductor

Before plugging in the dock side power cord check to see that all vessel AC breakers are off. This includes the ELCI breakers as well as both the main and equipment breakers at the AC ship's control panel.

When connecting the shore power cord into the typical shore power station twist the cord into the receptacle and turn clockwise until tight. This procedure ensures a waterproof and snug connection.

When not using the power cord energize the cord reel to remove slack and to position the power cord end inside the vessel shore power inlet. Turn the threaded cover clockwise until tight to ensure a watertight connection.

Electric Shore Power Cord Reel

Your yacht features a 240 volt capacity dock side cord reel and a DC powered cord reel retrieval system. The dockside cord is rated at 50 amps and is attached to a reel which releases the needed cord length when pulled out.

The power cord is accessible from the aft starboard swim platform and the reel itself is located in the aft bilge. The power cord retrieval is accomplished by activating a switch which powers a 12 volt DC motor.

The yacht end of the cord is directly wired into the cord reel. Therefore, there is nothing to be plugged into the yacht.

The cord end must be plugged into the marina dock power center. Make sure you twist the cord end to lock it once in the marina power center 50 amp receptacle. *Allow for cord allowances in tidal zones.*

Operation



To activate the reel, press **RELEASE** once on switch to unlock reel before pulling cord.

Next, press **RETRACT** and hold switch to retrieve the cord inside the reel. While retrieving the cord, guide it as needed

to eliminate the receptacle from water immersion which may lead to terminal corrosion.

Note that the DC motor is protected by an automatic reset thermal device. Should it activate due to a motor overheating situation the motor will return to normal operation once it cools down and the thermal device deactivates.



TYPICAL ELECTRIC SHORE POWER CORD REEL



WARNING

PREVENT SEVERE INJURY OR DEATH!
ALTERNATING CURRENT (AC) CAN KILL YOU!
DISCONNECT
ALL ELECTRICAL POWER SOURCES
BEFORE ATTEMPTING TO REPAIR OR REPLACE
ANY ELECTRICAL COMPONENTS.



WARNING

PREVENT SEVERE INJURY OR DEATH!
NEVER USE EXTENSION CORDS
OR IMPROVISED CORDS
IN SHORE POWER/MARINE INLETS.
USE ONLY UL APPROVED MARINE SHORE
POWER CORDS MATCHING ORIGINAL WIRE
GAUGE AND AMPERAGE.

Tips- Marina Shore Power Stations

As you become a more experienced boater you may engage in longer cruises with over night stays. It is most frustrating after a day of hard boating to pull into a marina and find your shore power cord does not adapt to the marina shore power station.



TYPICAL MARINA
SHORE POWER
STATION

This may be especially true stopping at older marinas built before the 1978 National Electric Code was enacted for these facilities. Therefore, it is recommended that you purchase several shore power adapter cords to meet various marina plug footprints.

You may want to carry a 50 amp "Y" adapter cord for remote hook ups where only 30 amp service is available. This will permit you to connect 2 (30 amp) dock side cords to the adapter cord and run them to the 30 amp service at the marina power station.

Note that with the above remote hook up selected high voltage circuits may not operate.

A point to remember is that sometimes a chart plotter will provide local cruising information including marinas and facilities they offer but normally they do not provide the power voltage available at dock side. Call the marina harbor master for specific dock side voltage and services available at that site.

Shore Power Possible Problems/Solutions

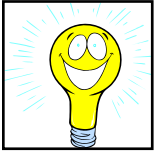

1. After the dock side cord is hooked up to the marina dock power center and the AC ship's panel main breaker for shore power is activated no voltage is shown on the main panel

AC volt meter.

Check the breaker on the marina dock power center to ensure it is activated.

Check the ELCI breaker/voltage sensing device. The "power" icon should show green. If a leakage fault exists a "red" icon will light indicating the breaker is "tripped". If needed, use the test button to reset the breaker. Read the ELCI information following in this chapter.

2. The marina dock power center lacks a 50 amp twist plug inlet.

Call the dock master or marina personnel. An adapter cord may be available from the dockage facility. **NEVER IMPROVISE ANY TYPE OF CORD OR POWER INLET CHANGES!**

Additional cord adapters can be found at retail boating outlets.

ELCI SYSTEM (TYPICAL)

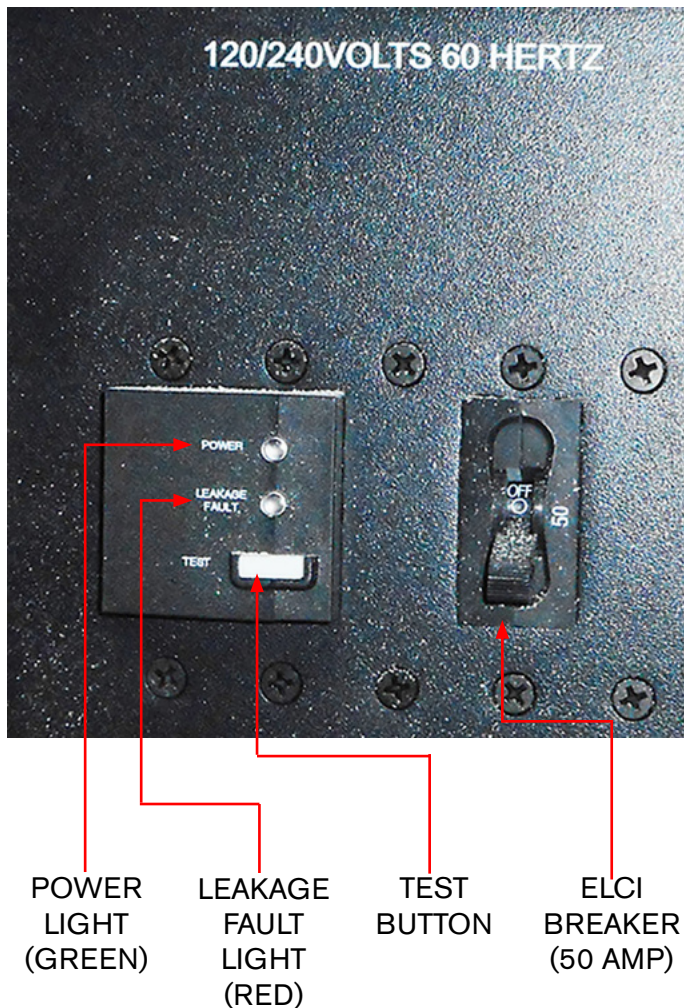

Once the shore power cord is attached to marina's dock side power the vessel dock side power cord inlet travels through the shore cord and then to the ELCI actuator enclosure (shown above).

Once through the ELCI power continues to the ship's main AC control panel. Note that the shore line breaker above is of a single throw double pole design. The main ELCI breaker above features leakage fault technology. If the 50 amp ELCI breaker trips find the cause of the problem before resetting the breaker.

The ELCI stands for "Equipment Leakage Circuit Interrupter". There are two potential failures in a boat's electrical system that can put people on or around a vessel at risk of lethal electrical shock. In a properly functioning marine electrical system, the same amount of AC current flows in the hot and neutral wires.

However, should electricity "leak" from this intended path in these two wires to ground, this condition is referred to as a "ground fault". An example of this is an insulation failure in the wiring of an appliance.

Furthermore, a ground fault can occur when the grounding path is broke through a loose connection or broken wire. As an example a shore power ground wire may fail due to fatigue caused by constant motion and stress. Faulty grounds can go undetected; a simple continuity test may not reveal problems.

When these 2 conditions occur at the same time, it may produce tragic results. The combination of a "ground fault" and a faulty ground could result in the metal parts of the vessel and underwater gear to become energized. If this condition exists, besides being a hazard to personnel on board there is increased danger to swimmers near the boat. The result could be shocking people on board and swimmers could receive a paralyzing dose of electricity and drown due to loss of muscle control.

ELCI System Continued

An ELCI provides protection for the entire boat and features a trip threshold which provides ground fault protection for the entire shore power system beyond the ELCI.

The ELCI protection on individual shore power lines combined with GFCI'S will reduce the risk to those on the boat, dock, and in the water surrounding the vessel.

Another feature of the ELCI is a "leakage fault" detector located on the side of the ELCI breaker itself. The leakage fault feature detects a change in the neutral wire current.

Should the current change more than 30 Ma or about 1/3 of an amp the unit senses the difference and will "trip" the breaker causing the leakage fault LED to illuminate red. This clearly indicates that the trip occurred as a result of leakage. Before re-setting the ELCI breaker determine the cause of the leakage fault.

A proper operating alternating current system will display a green illuminated LED at the "power" marked area of the ELCI.

Periodically test the ELCI by depressing the "test" button. The breaker should "trip" indicating the system is functioning properly. Simply reset the breaker. The leakage hazard helps prevent serious equipment damage and possible fire.

After the neutral and the 2-120 volt conductors exit the ELCI they run directly to the ship's main AC control panel.

The ELCI can at times undergo a process called "nuisance tripping" which can cause a "tripped" breaker. This can be caused by overloads in the electrical draw or sometimes caused from unbalanced loads. One way to minimize the situation should it occur is to monitor closer the energized devices on the vessel which will assist in keeping the total amperage used to a minimum and the loads between panel legs more balanced.

ELCI Leakage Fault Detector LED Information

As a central segment of the ELCI system there are two LED lights with a “test” button located at the shore power inlet. With the breaker in the ‘on” position and the shore power cord hooked up these LED lights may show variations in color to provide system conditions.

ELCI LED indication as follows:

1. Green LED On- Red LED Off

Line voltage is present, the breaker is closed, and the device is protecting the circuits against over current and leakage current.

2. Green LED Off, Red LED On

The device has detected leakage current and has opened the circuit breaker.

3. Green LED flashing, Red LED Off

The circuit breaker has opened due to over current or has been manually turned to the “off” position.

4. Green LED Off, Red LED Off

Line voltage is not present. Check cord connections and marina breaker for “on” position.

Note: Check circuit at least monthly by pushing in the white switch marked TEST. When depressed, the breaker should return to the reset position indicating the ELCI circuit is operating properly.

For further information on the ELCI PC-series refer to the Carling Technologies web-site.

AC Ship's Panel (Typical)

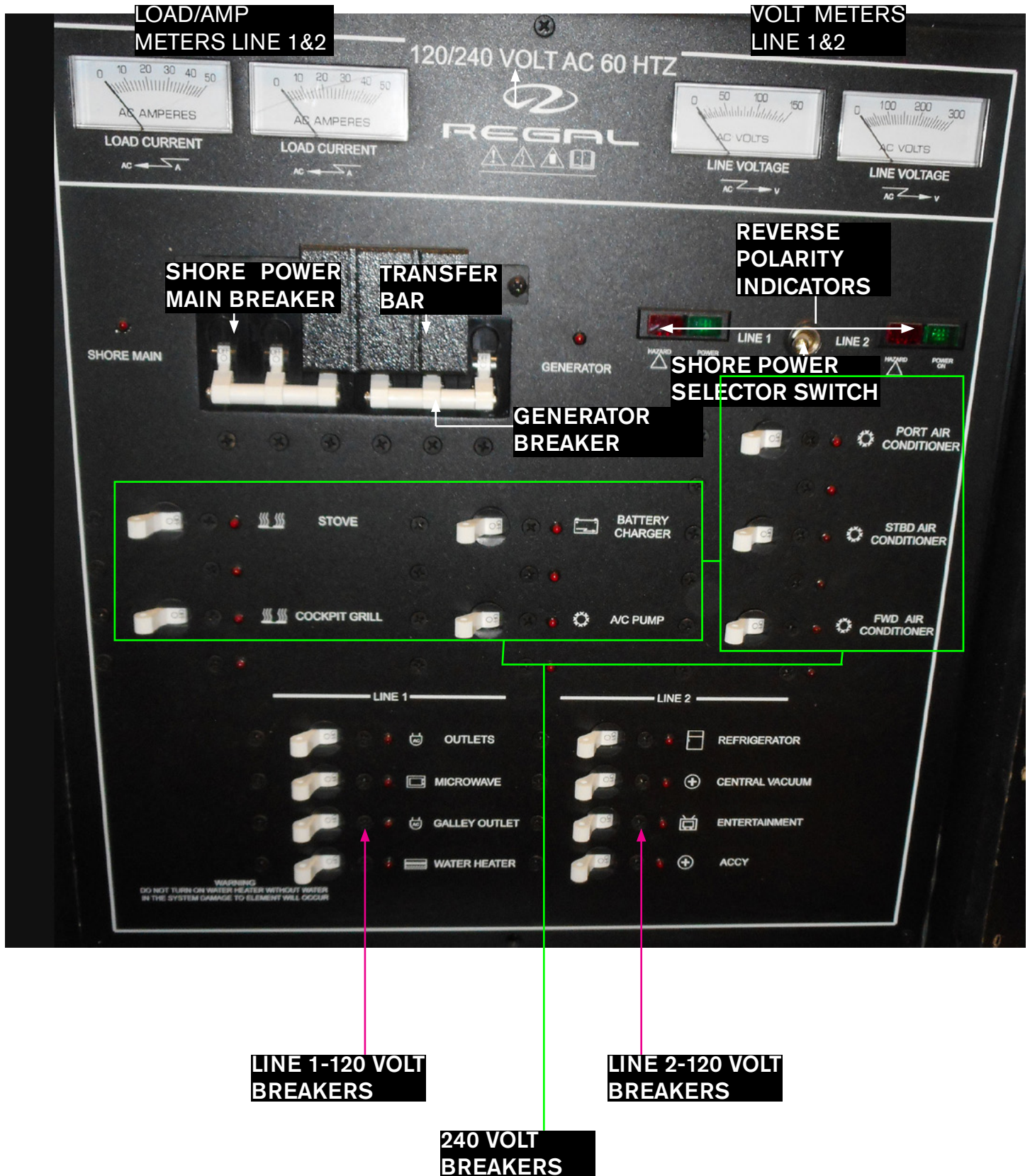

LINE 1-120 VOLT BREAKERS

LINE 2-120 VOLT BREAKERS

240 VOLT BREAKERS

AC Ship's Panel Continued

The typical AC (alternating current) ship's panel controls all high voltage components on your vessel. This panel features 120/240 volts AC at a frequency of 60 cycles. Downstream equipment is controlled by individual breakers using 120 or 240 volts depending on the component (See previous page). Voltage is supplied by either a 50 amp shore power cord (moored) or by generator (at sea). The panel features voltage and current displays for each line.

Reverse Polarity Indicator

After plugging the 50 amp shore cord into a marina receptacle and before activating the main breaker visually check for a green light at the reverse polarity indicator. The green light indicates there is no reverse polarity. If a red light appears on the reverse polarity indicator a hot wire and ground are probably reversed somewhere in the circuit from the dock to the main panel. *Note that the above situation will not show up in the ELCI circuit.*

In all cases do not activate the main panel breaker. Take immediate corrective action to find the cause of the reverse polarity situation. At this point, disconnect the shore power cord from the marina power center and call for professional assistance.

50 Amp Main AC Panel Shore Power Breaker

As mentioned earlier, there are two main shore power 50 amp breakers on the ship's main AC panel. These single throw, triple pole main breakers control power to the 240 volt components and when activated deliver current by a system of sub breakers through a dedicated Line 1 and Line 2 of the panel which are the 120 volt components. Before you activate or deactivate the main breaker make sure all sub breakers are in the "off" position. This prevents any excessive equipment motor draws and may eliminate any system arcing.

With the reverse polarity indicator displaying the green icon, activate the main shore breaker by flipping the single throw arm to the "on" position. 240 volts of AC electricity is now available

Note the other main breaker labeled generator is to be activated after the generator is started. See the next page for generator breaker activation.

At this point turn on sub breakers as needed. Always be conscious of the load current meter and the need to balance the shore power load where possible.

AC Ship's Panel- Continued

240 Volt Main Ship's Panel Breaker Description (Typical)

Stove- This 10 amp breaker controls the galley stove located in the salon area.

Cockpit Grill- This 10 amp breaker controls the electric grill located in the outside patio area.

Battery Charger- This 10 amp breaker controls the battery charger located in the bilge. It is recommended that when leaving the boat for extended periods this breaker be left energized in order to keep the ship's batteries in a charged condition (dock side cord must be hooked up).

AC Pump- This 5 amp breaker controls the air conditioning system pump located in the bilge. The pump supplies water to all air conditioning units on board. *NOTE THIS UNIT IS 240 VOLTS AC.*

Port Air Conditioner- This 10 amp breaker controls the air conditioning unit located behind the salon refrigerator.

Stbd. Air Conditioner- This 10 amp fuse controls the air conditioning unit located behind the starboard aft seat panel.

Fwd. Air Conditioner- This 10 amp fuse controls the air conditioning unit located under the stairway.

120 Volt Main Ship's Panel Breaker Description (Typical)

Outlets- This 15 amp breaker controls various receptacles. They are all GFIC protected.

Microwave- This 15 amp breaker controls the microwave located in the salon.

Galley outlet- This 15 amp breaker controls various receptacles. They are all GFIC protected.

Water Heater- This 15 amp breaker controls the hot water heater located in the bilge. *Note to never activate the breaker without water in the water heater tank as water heater element damage will occur.*

Refrigerator- This 10 amp breaker controls the refrigerator located in the salon galley. Activate this breaker when at mooring or on generator power to keep the freezer portion of the refer activated.

Central Vacuum- This 15 amp breaker controls the vacuum located under the forward cabin storage.

Entertainment- This 15 amp breaker controls all televisions and optional satellite TV receiver.

Accy- This 15 amp breaker currently is not used. When adding any AC accessory make sure the amperage is safely within the breaker limitations.

GFCI Outlet (Ground Fault Circuit Interrupter)

Sometimes current in a circuit escapes its normal route and finds a “ground fault”. If that vehicle ends up to be your body and the current passes through your heart the results could be deadly. The outlet contacts close between 4 and 6 milliamperes.

A ground fault interrupter or GFCI senses the difference between the hot and neutral wire current before a fatal dose can be conducted and in a fraction of a second cuts the current.

The GFCI devices used in homes are normally not ignition protected and of the 15 or 20 amp variety. Your boat uses a 15 amp GFCI. By using a GFCI as the first receptacle in the circuit all the receptacles down stream on the same circuit are protected by the initial GFCI. This is accomplished by attaching the hot wires to the line terminal of the GFCI receptacle and the out-going hot wire to the load terminal. The neutral wires also use line and load terminals on the opposite side of the GFCI receptacle.

You can identify the GFCI primary receptacle by the test and reset breaker in the center of the device. Check the GFCI protection monthly. If a problem develops with the GFCI circuitry call a marine electrician to access the situation.

The GFCI outlets are especially useful when electrical equipment is employed such as a drill or in the head with the use of personal devices such as curlers and hair dryers. *Note to never use any electrical devices when puddling water is present to prevent a possible shock hazard.*

Note: See the GFCI description on the following page.

The GFCI is programed to protect a person from line to ground shock hazards which could occur from various electrical devices operating off of the device or receptacles down stream. It does not prevent line to ground electric shock, but does cut down the exposure time to a fraction of a second before the device trips. It does not protect people against line to line or line to neutral faults. Also, it does not protect against short circuits or overloads; this is the circuit breakers job.

All GFCI's should be tested monthly to make sure they and the receptacles they protect “down-stream” are protecting against ground-faults.

GFCI Outlet (Ground Fault Circuit Interrupter)

Newer style GFCI's must automatically monitor ground fault interrupting functionality every 3 hours or less. If the device can no longer provide GFCI protection, it must deny power and provide a visual indication that it can no longer provide protection.

Your boat uses a GFCI's featuring the following:

1. Power indicator (solid green)
2. Trip indicator (solid red)
3. "End of life" indicator (flashing red)

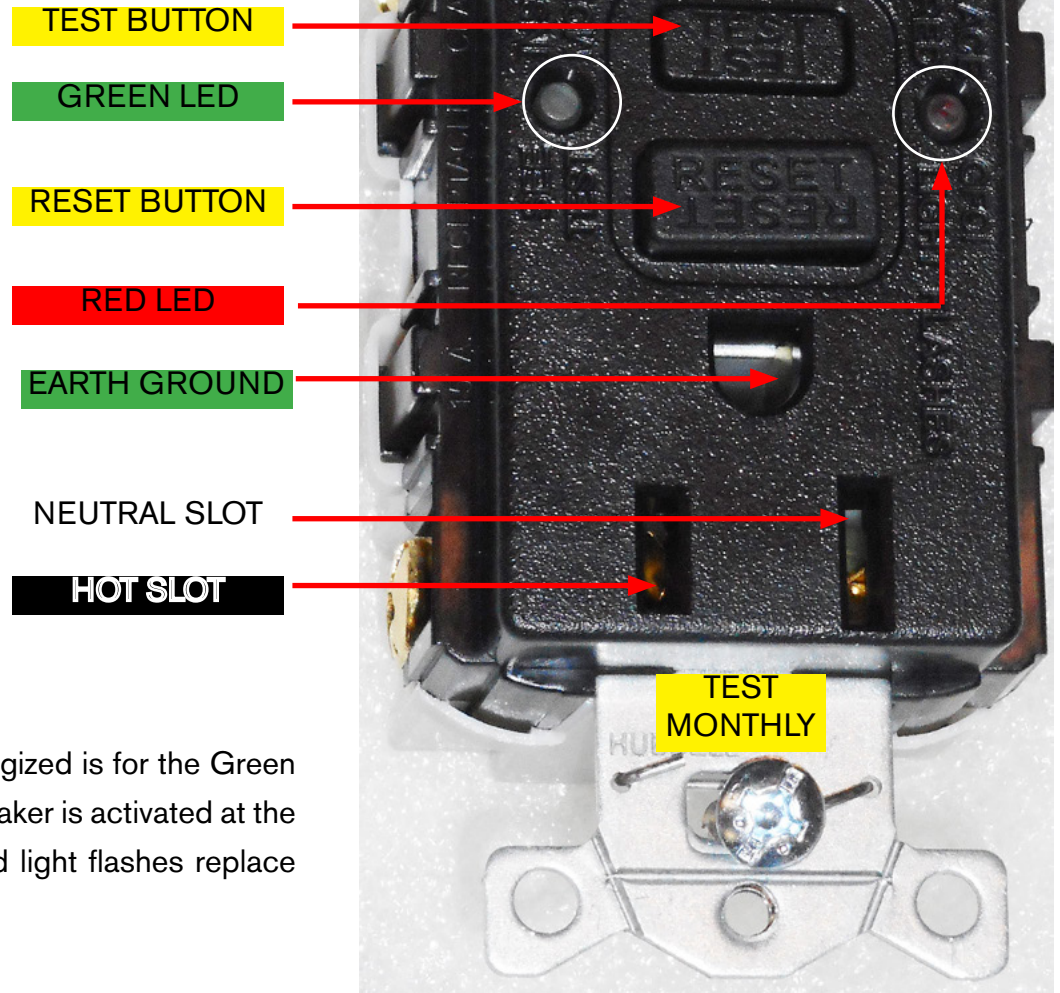

Normal operation when energized is for the Green LED to light as the outlet breaker is activated at the main AC ship's panel. If Red light flashes replace GFCI receptacle.

GFCI Outlet- Continued

Testing GFCI'S

To test a GFCI find a 120 volt night light or small lamp to plug into the GFCI outlet. Try it in another circuit first to make sure it lights.

After the lamp is plugged into the GFCI outlet the lamp should light. Now press the “test” button at the GFCI receptacle center. The GFCI's “reset” button should pop out and the lamp should go out. This means the GFCI itself is functioning properly. Press the “reset” button to restore power to the outlet. Test each GFCI circuit monthly.

You can use the lamp to check receptacles downstream from the GFCI. All receptacles should light the lamp and should go out when the “test” button is pressed.



Also, GFCI downstream receptacles can be tested with a plug-in type GFCI tester. This tester contains a GFCI test button which accomplishes

the same thing as the GFCI receptacle built-in test button. This tester can be purchased at electrical supply houses or marine retailers.

Ignition Protected Devices

Many electrical devices in everyday use tend to “arc” or spark when being used. These include motors, fans, switches, relays, etc.

Boats in general use many of these same devices but they are protected from any sparking that may cause the device to ignite with any vapors that are typically found in the engine room and/or fuel tank compartments.

When replacing any electrical device especially in the bilge or engine room make sure it is ignition protected. This means it has been tested and normally the device is stamped with a marking making it safe to use. Most automotive type devices are not ignition protected especially engine starters and alternators.

Possible Problems/solutions (GFCI's)

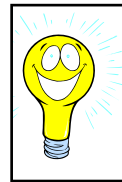

1. If the “reset” button does not pop out, the GFCI is probably defective and should be replaced.

2. If the “reset” button pops out one time but tends to stick the next the GFCI should be replaced.

3. The GFCI “reset” button pops out when something is turned on. This may indicate an internal wiring problem with the GFCI or there may be a ground-fault down stream.

4. The GFCI “reset” button is in the pressed position and nothing works. Check the appropriate breaker at the main ship's AC control panel to make sure it has not “tripped” or as been deactivated.

Galvanic Isolator (Typical)

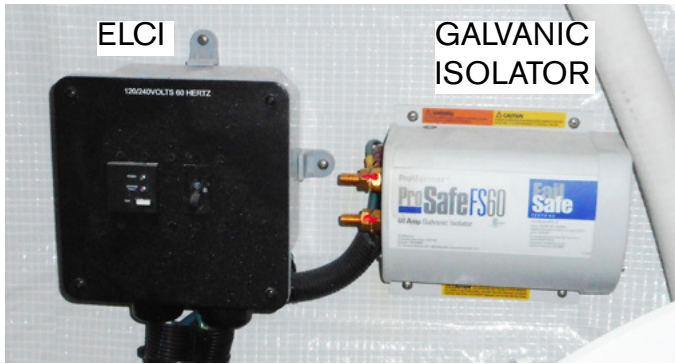

As part of the AC boat circuitry the green ground wire takes a different path. It enters via the boat's shore power inlet and travels to a galvanic isolator via the ELCI which is accessed in the bilge.

A 60 amp (60 hertz) galvanic isolator for domestic use is connected in series with the AC grounding "green" wire. The purpose of the galvanic isolator is to isolate the boat's grounding system electrically from the dock and other vessels below 1.4 volts but to maintain a connection to the shore green ground at high voltage potentials. The low voltage isolation will prevent the vessel's zinc from protecting the underwater metal hardware on another vessel sharing the same AC common green ground wire. This eliminates the possibility of galvanic interaction from other boats on the same dock circuit and permits your anodes to protect your boat. The green ground or "bonding wire" runs from the boat's shore power inlet to a galvanic isolator stud. From the other stud of the galvanic isolator it runs to the AC ground buss located behind the AC main ship's control panel at the atrium stairway. Note that the stud nuts must be torqued and maintained at 8.8 inch pounds.

Since the galvanic isolator is not polarized either terminal can be used for the inlet or outlet side for the green grounding wire.

Precautions/Galvanic Isolator Warnings

Warning- It is extremely dangerous to swim or be in the marina water due to potential AC current that may be present in the water. Take all necessary precautions as this may be life threatening.

Caution- This device does not provide a status monitor. Following a lightning strike this unit may not continue to provide galvanic isolation protection.

Warning: The fan will operate only when there is a fault to ground and the isolator is conducting current. If you notice the fan running immediately disconnect the shore power and contact a qualified marine electrician to isolate and repair the problem with the boat or the shore power connection. Remember, never cover the fan holes.

Caution: Never test the isolator. Troubleshooting the galvanic isolator shall be done by qualified personnel only.

Generator-Typical

Overview

A generator (gen-set) is used to provide on board alternating current (AC) when the vessel is unplugged from the dock side cord. Generator frequency known as hertz is domestically set at 60 while overseas countries normally require a setting of 50. As the generator reaches full rated no load output (amps) at 60 hertz it should display 120 volts. At 50 hertz it should display 240 volts.

The generator option is located in the engine room. Some basic system components are identified below. The generator features a sound enclosure which reduces noise and enables quick access for most inspections, troubleshooting and routine maintenance.

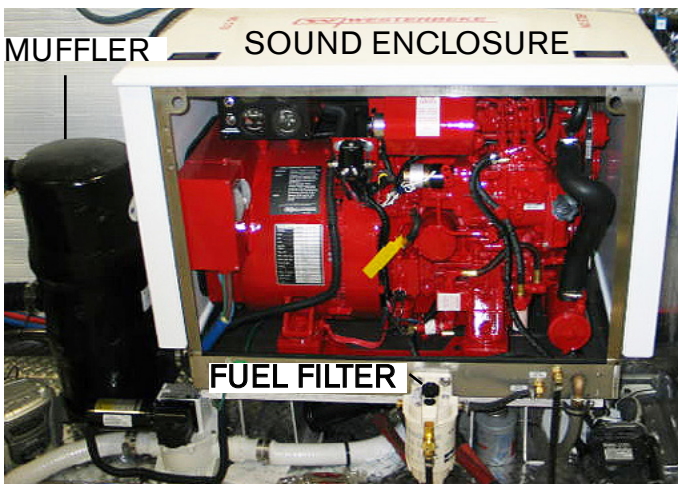

Generator Fuel System (Typical)

The generator is supplied by the same fuel tanks as the engines. The generator feed valve is normally marked for identification purposes.

Familiarize yourself with the location of all equipment and valves.

Note that normally the generator feed and return use a 1/4"inch barb fitting located on the fuel tank. The feed portion will use a anti-siphon valve.



The fuel system features an in-line fuel filter located close to the generator. It's job is to keep fine particles and water out of the generator fuel system. Refer to the vendor information for periodic maintenance schedules.

Clean fuel is the life line of generator performance. Since water is heavier than fuel it will settle at the bottom of the water separator filter. Periodically check the filter for foreign debris and water in the fuel supply. To check the filter unscrew the filter using an oil filter type wrench that fits on the bottom. Do not use a strap type wrench since it may distort or damage the filter housing. Use an environmentally safe container to catch any contaminated fuel. Dispose of according to local, or state regulations. Carry extra water separator filters on board.

When you turn the filter upside down note that any water in the gasoline will gather at the bottom of the container since it is heavier than gasoline and will appear as a different color and consistency and normally will move back and forth independently from the gasoline mixture in the container.

After inspection spin on the filter by hand until tight. Start the engine and check for fuel/air leaks.

Typical Generator Electrical System

The generator starting system uses the house battery. The generator is normally started at the 12 volt ship's control panel located at the atrium but it can also be started using the remote instrument panel located at the generator itself as needed. The latter is especially useful while maintenance is being conducted.

The generator remote instrument panel shown at the right features temperature, oil pressure, exhaust, speed, hour meter, on/off, start and stop switches. This panel is found inside the access door on the generator sound enclosure in the bilge. The start and stop switches by name and function are identical to the switches on the remote panel.

As part of the generator electrical system an 8 amp fuse protects the remote instrument panel wiring circuit. See illustration.

The emergency stop switch shuts the fuel off to both the remote and ship's main control panel and is normally for maintenance purposes. See illustration.

A DC manual reset breaker protects excessive current draw or electrical overload anywhere in the generator engine wiring. Should this breaker trip the generator will shut down. Reset the breaker only after the cause of the problem has been determined. See illustration.

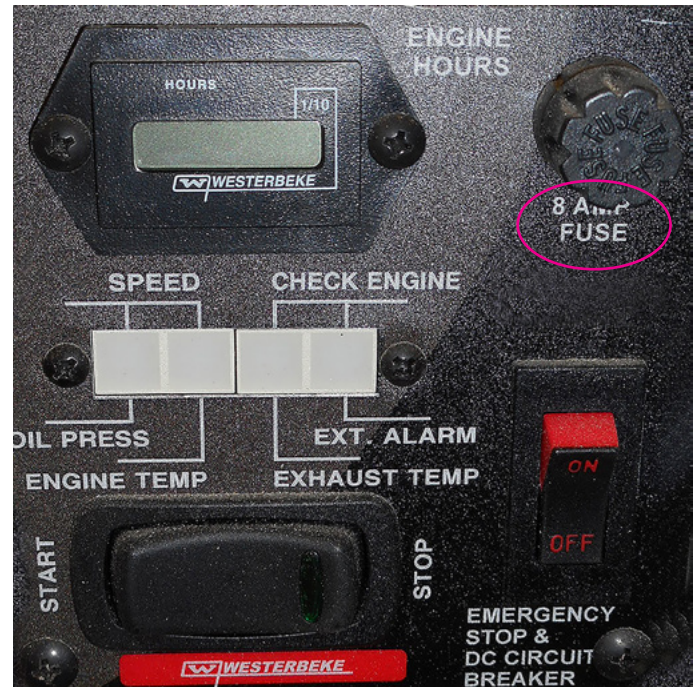
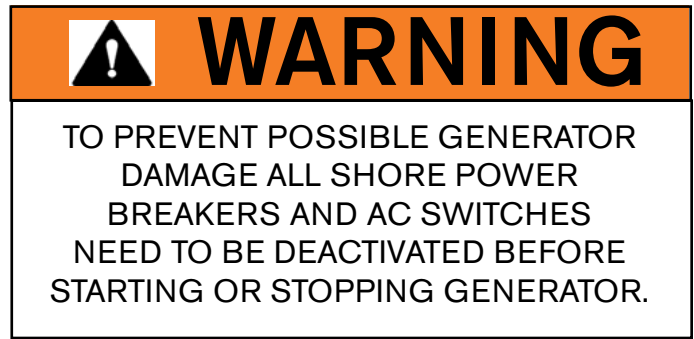

REMOTE GENERATOR PANEL SHOWING TOGGLE STYLE START/STOP SWITCH AND EMERGENCY STOP AND DC BREAKER

Note that the generator remote panel shown above is located in the engine compartment accessed through a cover plate.

Note for starting generator at the remote panel simply depress the start portion of the switch and the starter will crank over the engine. Once it starts release switch. Follow the same procedure for the stop cycle by depressing the stop portion of the toggle switch until the unit stops.

Before Starting Generator

The following items should be checked each time before starting the generator. This covers the basic system components.

- Turn generator sea cock off. Check strainer for debris. *Turn generator sea cock on before starting it.*
- Ensure that all main panel and equipment breakers are off.
- Inspect the generator for fuel, oil, exhaust or water leaks.
- Check generator engine oil level. Top off with correct type and viscosity as required.
- Check coolant for proper level at recovery tank. Add factory recommended coolant as needed.
- Check the main fuel tank to ensure there is adequate gasoline for both the generator and the engines. Apply the one-third rule.
- Check for loose wires at the alternator.
- Check the batteries (weekly).
- Check drive belts for wear and proper tension (weekly).
- Record the hour meter reading to meet maintenance scheduling.
- Check the blower for proper operation. Start blower and let run at least 4 minutes before attempting to start the generator. Run blower continuously while generator is running.

Starting Generator

Again, make sure the generator sea cock is open before starting generator. Failure to do so could result in damage to the seawater pump impeller or serious engine overheating damage.

Ensure that the main ship's control panel breaker is in the ship position.

Start the generator blower. Run blower while generator is running.

At the ship's DC panel energize and hold the generator run switch as the generator cranks and starts. As it warms up check for exhaust and fluid leakage.

If the engine fails to start after the first attempt, close the sea cock before starting the next attempt. Let the engine starter motor cool down for at least one minute before attempting to restart the generator. Failure to close the sea cock after 1st attempt may cause sea water to enter the exhaust piping, silencer and/or engine. A water filled exhaust piping and silencer may further hinder generator starting and cause sea water entry into the engine cylinders through the exhaust valve. Water ingested into the engine may cause serious engine damage which is not covered under warranty. Reopen sea cock before attempting to restart generator.

If water has entered the exhaust system, close the sea cock and drain the water from the exhaust system at the silencer's drain plug before attempting to start the generator. If excessive cranking is a continuing problem or the unit fails to start after 3 attempts have it including the exhaust system checked by a professional.

Starting Generator (continued)

At the ship's main AC control panel slide the (transfer bar) to the left. Activate the generator breaker.

At this point AC voltage should display on the AC line voltage meter. Activate the desired AC equipment breakers.

Stopping Generator

To stop the generator follow these steps at the ship's main control panel;

1. Turn to the "off" position all AC equipment breakers.
2. Turn to the "off" position the 50 amp AC generator breaker. At this point, no AC line voltage will be displayed at the AC volt meter. Let the generator run for 3-5 minutes without a load to cool down.
3. Stop the generator by pressing down the "stop" switch on the ship's DC panel. Hold until it stops.

Typical Generator Exhaust System

The generator exhaust system features a dual tier operation. As the water and exhaust exit the generator they travel to the muffler. The muffler discharges the heavier water out the muffler bottom and through the hull. The exhaust itself is exited out the muffler top and through the hull. The benefits of the system are two-fold. First, the actual decibel or sound level is decreased. In addition, the lower resonating sound is more pleasing to the ear. Colder climates may use a drain plug in the muffler.

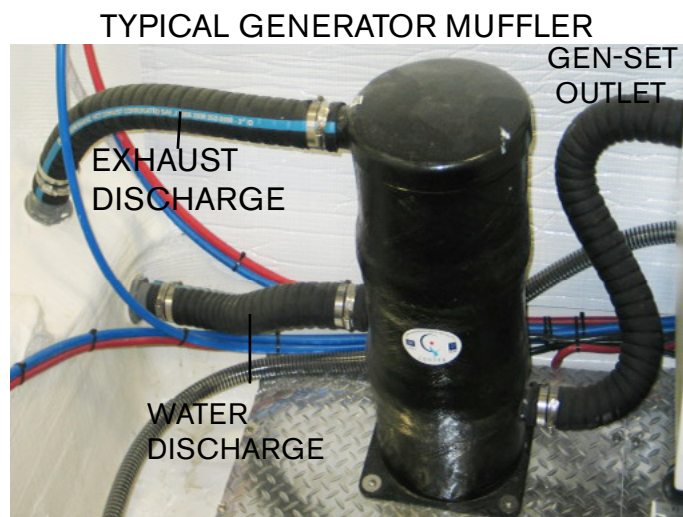

Before departure always check the hose connections for signs of water and air leaks. Tighten hose clamps periodically as needed. Check entire exhaust system for leaks and fastener tightness. After starting generator, always check for water flow at the generator discharge.

Typical Generator Valve

The generator features a scoop component under the hull to step up sea water volume to the sea water strainer. The scoop is part of the generator sea cock system. Located in-line to the generator is a valve. The purpose of the valve is to let sea water travel to the generator when the generator is running as it is in the “open” position and thus water flows through the generator and muffler-exhaust system eventually overboard. The valve is tied into the generator electric fuel pump system. When the generator is running the pump is open. When the generator is off the valve is closed.

When the generator is not running there is still pressure in the water intake system to the generator through the scoop but the valve is in the “off” position and will not let water pass through to the generator and on to the muffler-exhaust system. Bottom line this valve prevents water from entering the generator and possibly damaging the generator due to excess water system pressure from the scoop component. See the valve photo below.



Possible Problems/Solutions



1. With generator main control panel activated there is no voltage at the AC line voltage meter. Check AC output breaker on the generator. It may of tripped due to an overload.

2. The generator quit do to overheating. Check the generator strainer for obstructions such as seaweed, plastic wrap, or shellfish. Be sure to turn sea cock off before removing the strainer basket.

Check generator outlet at transom for water output with generator running. If no water check for faulty generator in-line valve or sea water restriction in intake system. Make sure sea cock handle is open.

3. The generator will not start from the main ship's panel after being serviced. Make sure the generator mounted emergency stop switch is in the "off" position and the breaker has not tripped.

4. The generator will not crank over to start. Check-out the house battery condition.

Generator/AC Seacock/Strainer (Typical)

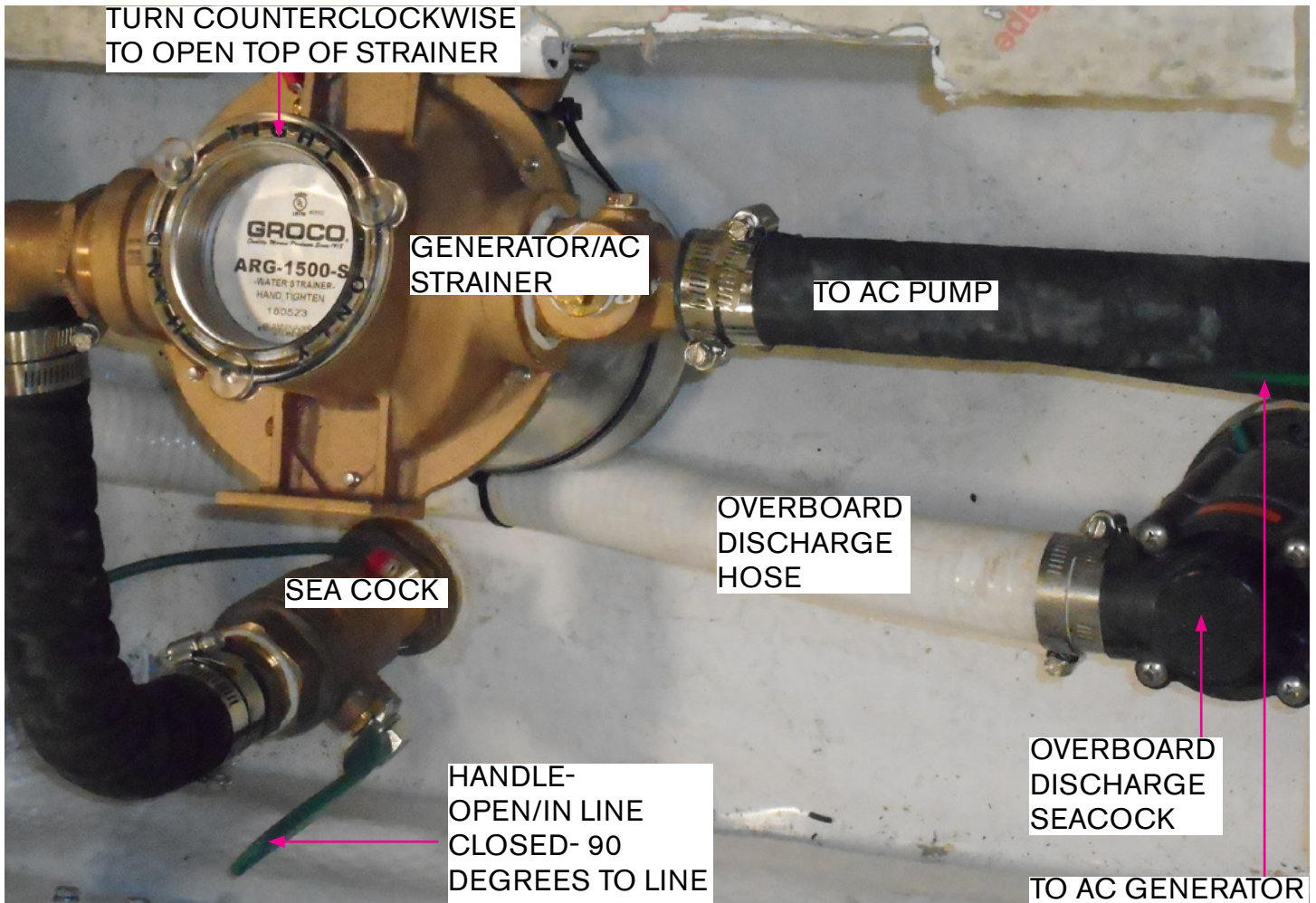

In the starboard bilge note the generator and the air conditioner share the same sea cock and strainer. Always ensure the handle is in line with the hose indicating an “open” condition before attempting to start these components . This will permit seawater to circulate through the generator and AC units.

To service the strainer type above make sure the sea cock handle is in the “off” position which is at 90 degree angle to the hose. Turn the strainer top counterclockwise to access the basket. Pull the basket out and remove any debris. Reinstall basket. Grease O ring and tighten strainer top. Do not overtighten if using a wrench. Set the sea cock handle to the “open” position. Start component and check for leaks.

Air Conditioning

The current air conditioning system onboard features 3 air conditioning units located to provide complete zone coverage. The system utilizes a single pump which delivers cooler seawater to each evaporator/condenser. The drain pan is rust free molded composite. Residue water exits through the shower box. Warmer seawater exits the vessel through a manifold and various thru-hull fittings.

A vibration isolation system reduces noise. The sound cover provides up to 50% further noise reduction which amounts to 3-5 db's.

The evaporator/condenser unit incorporates a compressor to compact the R-410A refrigerant which is comprised of fluorinated greenhouse gases.

The Elite control panels (thermostat) are located for complete zone comfort. A set of control panel reference system codes is provided for any type of service issue.

TYPICAL AIR CONDITIONING EVAPORATOR/CONDENSER UNIT

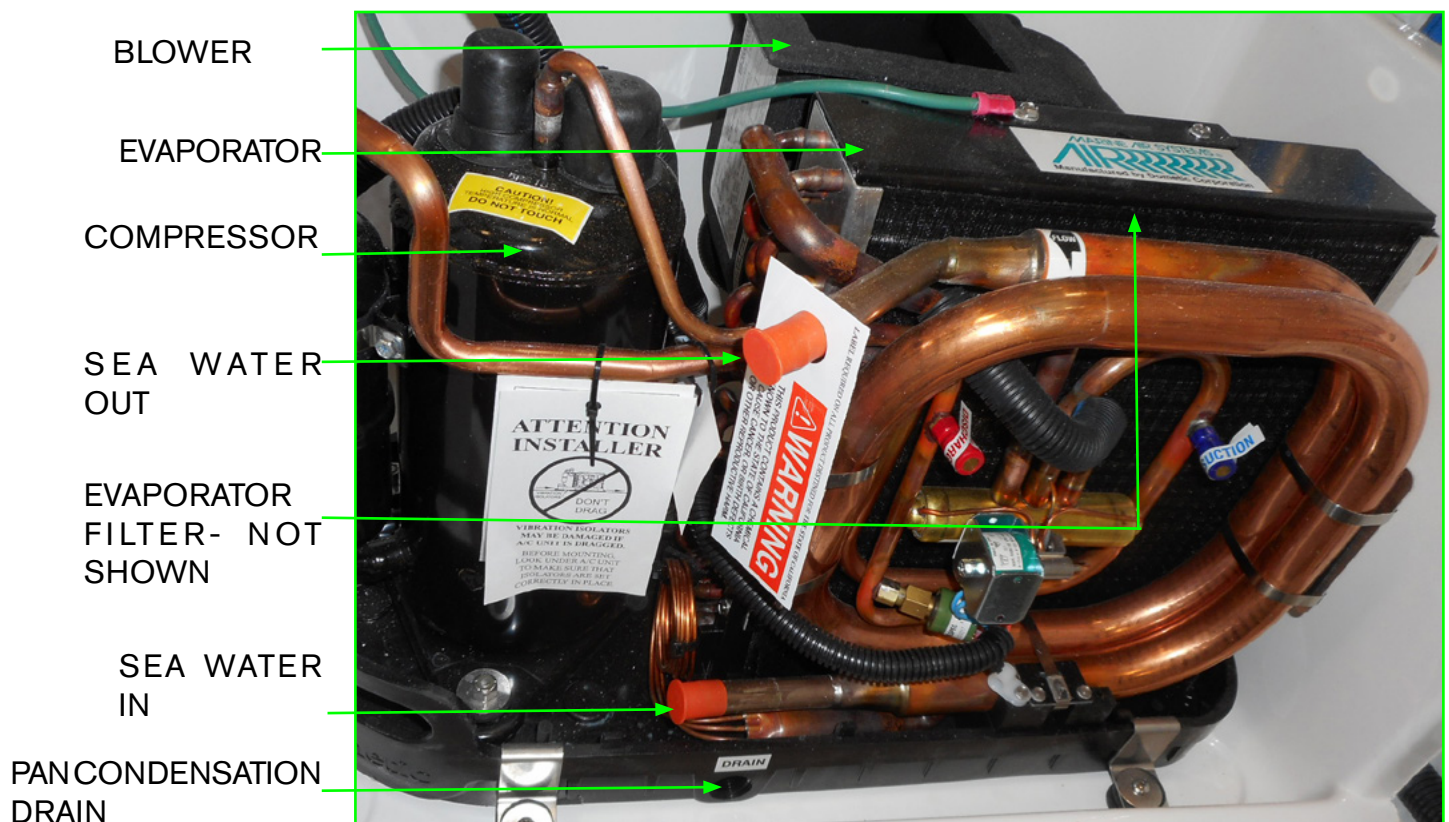

The 230 volt A/C pump is located in the bilge. It provides sea water to operate the 3 independent A/C units thru a manifold in the starboard bilge.

The pump sources water from a seacock/strainer that doubles duty for the generator.

Note: If the vessel is hoisted out of the water (except for winterization) make sure the A/C sea cock is turned to the "off" position before lifting the vessel. Failure to do so may cause the air conditioner to lose its prime and the A/C pump may quit on start-up do to a lack of water or cause pump failure. Remember to turn the sea cock "on" before re-starting the A/C units.

Remember that the strainer and seacock serve both the AC pump and the generator.



AC PUMP

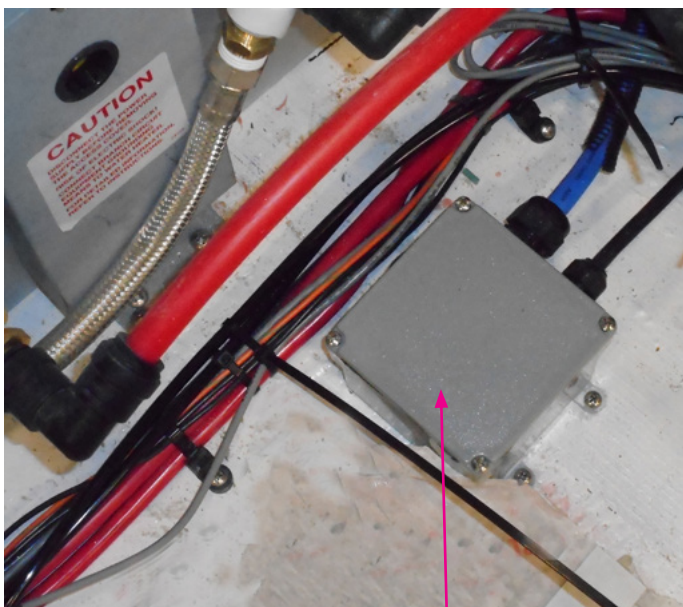

AC PUMP HARNESS JUNCTION BOX
230 VOLTS

Seawater is drawn thru the seacock into the AC pump. From the AC pump seawater travels to the bilge mounted manifold for distribution to the 3 air conditioner units on board. Note the manifold distribution description below of hose runs for service needs or troubleshooting.

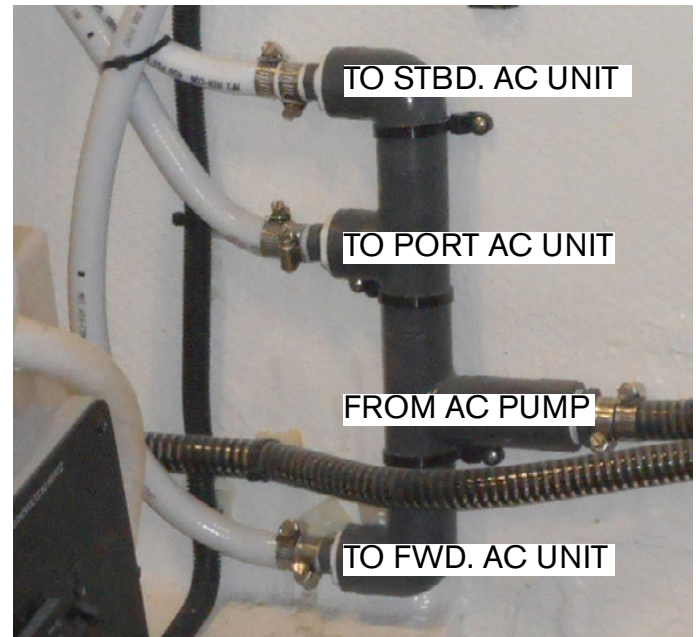

Note that all equipment, specifications, wiring or hose routing may be subject to change due to product improvement at any time.



WARNING

AVOID DEATH OR BODILY INJURY
DUE TO SHOCK!
AC PUMP LOCATED IN AFT BILGE IS
230 VOLTS AC CURRENT.
IF SERVICE NEEDED CALL LICENSED
MARINE ELECTRICIAN.

Reverse Heat

The air conditioning system feature a reverse heat cycle. This can be extremely valuable to boaters in colder climates especially for early spring and late fall cruising.

To accomplish reverse cycle heating, the R-410A refrigerant flows in the opposite direction through a reversing valve located on the evaporator/condenser unit. Heat is transferred from the seawater in the coil of the condenser to the R-410A refrigerant and then to the air as it is blown through the evaporator to the cabin.

Obviously, the temperature of the seawater will affect the air conditioner efficiency.

The temperature variance for cooling efficiency is:

Up to 90 Degrees F. (32.2 Degrees C.)

The temperature variance for heating efficiency is:

Down to 40 Degrees F. (4.4 Degrees C.)

Typical Air Conditioning System Operation

Below is a basic quick start-up checklist for the air conditioning system. For more in depth information, refer to the vendor operation manual.

Operations Quick Start-Up Checklist:

1. Check the AC seawater strainer for debris.
2. Make sure the AC seawater pump sea cock is opened completely (handle should be in-line pointing up).
3. Activate the desired air conditioner breaker on the boat's main AC control panel located at the ship's main AC panel.
4. Check the hull side for a steady stream of seawater. Seeing water here is normal when the AC pump is running. If stream is diminished or no water emits from the fitting immediately turn the AC pump off and investigate the cause of the problem.
5. Press the Elite zone thermostat Power button once to activate the air conditioning system. A blank screen displays when system is off and indicates present cabin temperature.
6. For cooling or heating press and release the Mode button until the desired LED is illuminated ie; automatic mode.
7. Press the Up or Down button to set the desired cabin temperature. To view the set point, momentarily press and release the Up or Down button.
8. Auto fan LED lights when Auto fan speed is selected.

Typical Elite Air Conditioning Control Panel

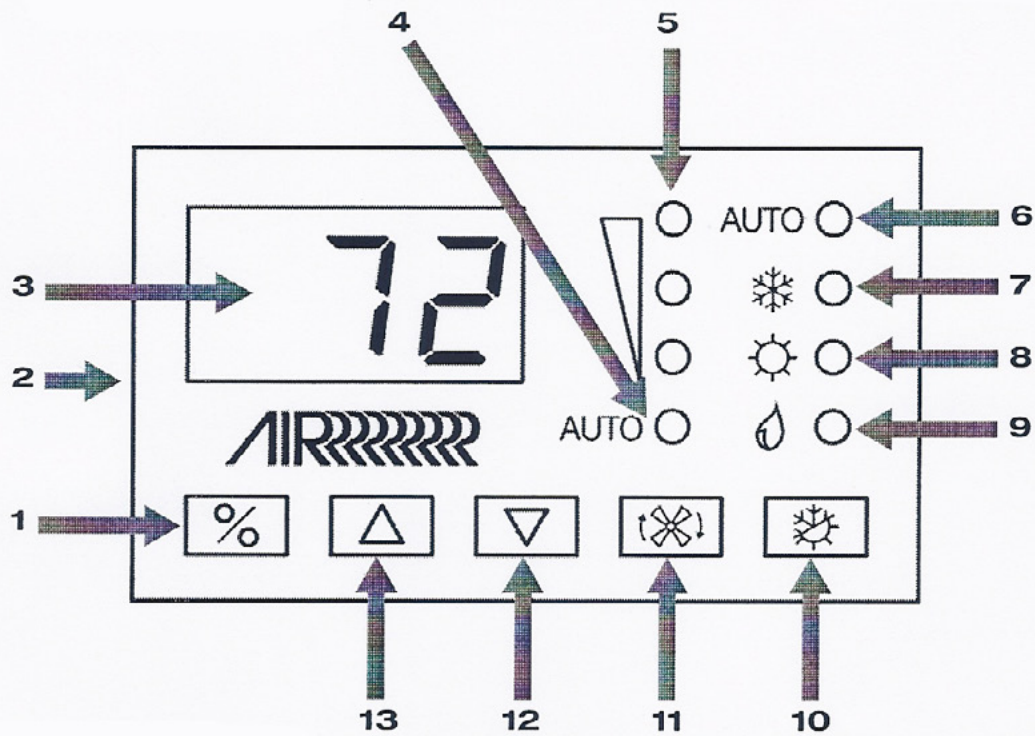

Elite Display - Diagram Legend

1	Power button	8	Heat Mode indicator
2	Temperature sensor	9	Moisture Mode indicator
3	Digital display	10	Mode button
4	Auto Fan indicator	11	Fan button
5	Manual Fan indicator (high, medium, low)	12	Down button - Lower temperature set point
6	Auto Mode indicator	13	Up button - Raise temperature set point
7	Cool Mode indicator		

Note: The Elite display continually monitors the system components. Should a problem develop it sends a diagnostic code to the control (thermostat) display. Refer to the vendor air conditioning manual (troubleshooting section) to assist in identifying any problem.

Air Conditioner Tips

Seawater Strainer

The air conditioner/generator seawater strainer is located in the bilge and should be cleaned periodically of debris which can inhibit or stop the fresh sea water supply. Always turn the sea cock handle to the off position (90 degrees to the hose fitting) before cleaning a seawater strainer.

Remove the basket by turning the plastic cap in a counterclockwise direction. Set the cap and the O ring aside. Pull the basket from the unit, rinse with water, air dry and reinstall. Sediment at the bottom can be removed by just turning the plug in a counterclockwise direction. Place a container under the strainer to catch the sediment. Coat the O rings with waterproof grease containing a silicone or teflon base. Reinstall O rings along with the plug and plastic cap. Turn on and check for leaks.

Drain Pans

As noted on an earlier page the AC evaporator/condenser features a 2" deep drain pan connected by a hose that runs to a shower box and eventually exits overboard. Periodically just like your home AC, the pan needs to be rinsed clean of debris and possible mold.

You can use a purchased product made specifically for cleaning AC units. Disconnect the outlet hose from the AC pan and install made up hose (5/8") that will catch the used solution to fill a small container. Dispose of the container in accordance with federal, state and local regulations. Pour the solution into the pan and allow time for it to drain. Reconnect the original drain pan hose when finished.

Condenser Coil Cleaning

Periodically the condenser coils are recommended to be cleaned. This procedure should be done by a professional since an acid solution must be used.



WARNING

PREVENT INJURY OR DEATH!
DISCONNECT
ALL ELECTRICAL POWER SOURCES
BEFORE ATTEMPTING
TO OPEN, REPAIR, OR REPLACE ANY
AIR CONDITIONER COMPONENTS.

Return/Evaporator Unit Air Filters

If installed, periodically check the air filter located on the face of the evaporator. You will need to access each air conditioner unit to reach the fine mesh filters. See the illustration on this page as it shows the evaporator filter location.

Remove, clean, rinse with fresh water, air dry and reinstall.

Starboard salon AC- At aft storage panel hull side to access grille.



Cabin area (below salon) AC- Bottom of atrium stairway to access rectangular grille.



Tips Regarding AC Returns & Ducts

1. Never block off any AC return grille or duct with an object. The unit will not operate properly without the proper air flow.

2. The salon port and starboard air conditioners use the counter top back splash slots (next to port windows; several sets) for both incoming and outgoing air. Never block these slots with objects as the AC system may not operate properly.



Possible Problems/Solutions

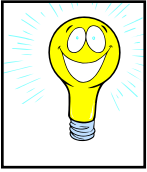

1. No or little water is noticed at the thru-hull fittings and a HPF fault code shows on the display which means the high pressure switch is open.

The strainer or intake hose may be clogged, sea cock may be closed, a hose may be collapsed or the AC pump may be defective.

2. Air conditioner will not start. Ensure the proper AC breaker is activated on the ship's main control panel.

3. No cooling or heating. Lower or raise set point on thermostat control to offset set point being satisfied. Check for obstructed seawater flow. Remove discharge side of pump hose to purge air (air-lock). Seawater temperature too high for cooling and too low for heating.

4. Fan coil is iced. Raise or lower control set point. Clean return air filter. Switch AC to heat until ice melts or as a last resort use a hair dryer to melt ice as needed.

EPA Fuel System- Typical

Note that dual or triple engines will contain a fuel feed for each engine.

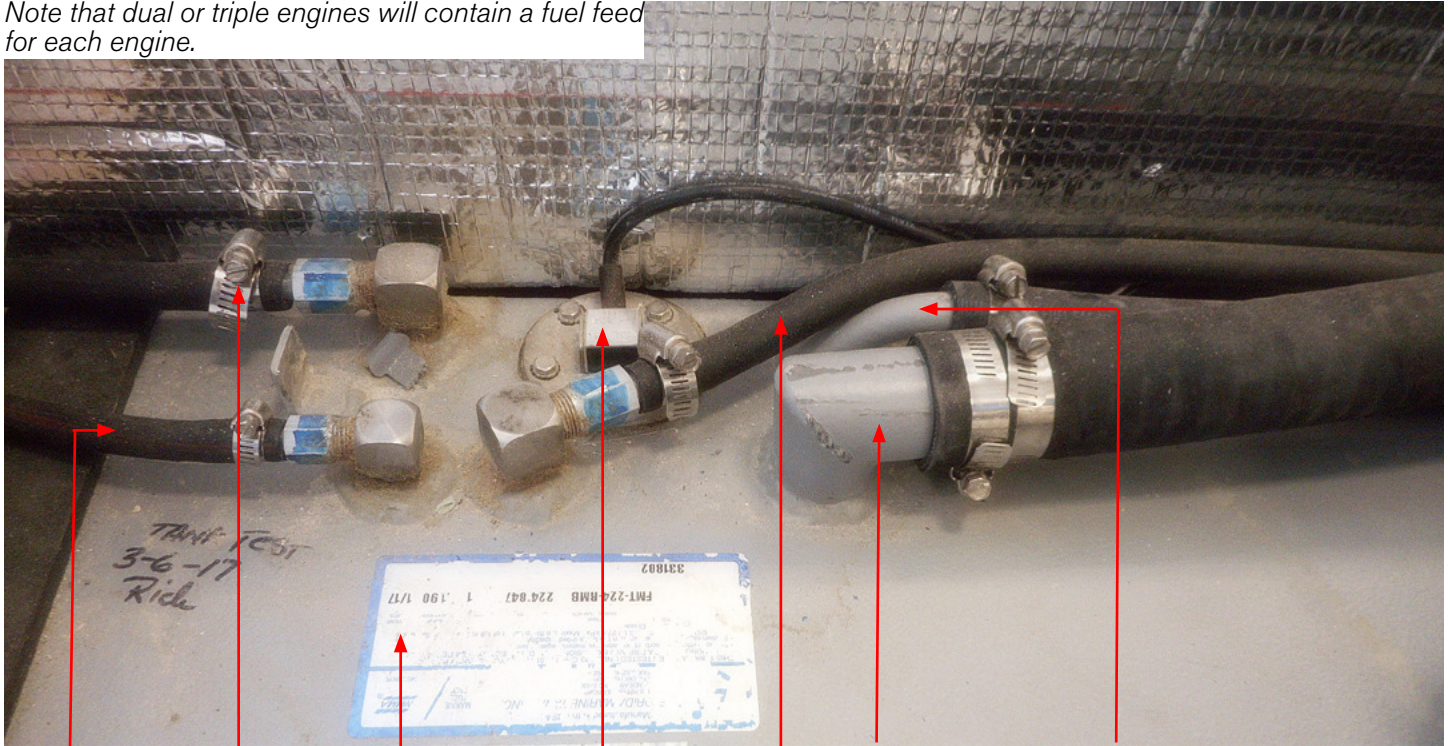

GEN-SET ENGINE FEED TANK FEED/HOSE FUEL SENDER UNIT ENGINE FEED FUEL FILL & HOSE TANK VENT & HOSE

Typical Fuel Tank

Vessels manufactured for *domestic* use are now required to be outfitted with an EPA compliant fuel system using an aluminum tank that passes a variety of tests. This system uses special valves and baffles located inside the fuel tank along with special hoses marked for low permeability. Also, there is a carbon canister in-line with the vent hose which functions much like the one in an automobile by filtering gas fumes. The carbon canister rarely needs to be replaced and is not a serviceable item. These tanks are tested and inspected along with the complete fuel system several times for safety requirements and quality by the fuel tank supplier, in house personnel and independent inspections by National Marine Manufacturers Association personnel using ABYC standards.

Fuel Fill Fitting

The fuel fill fitting is labeled “gas” and in addition displays the international symbol (See the next page). When fueling the boat keep the fill nozzle in contact with the fuel fill pipe since it decreases effects of static electricity. Always use the recommended fuel octane rating as specified in your engine owner’s manual.

Extinguish all flame producing agents before fueling!

 **WARNING**

AVOID SERIOUS INJURY OR DEATH FROM FIRE OR EXPLOSION, RESULTING FROM LEAKING FUEL. INSPECT SYSTEM FOR LEAKS AT LEAST ONCE A YEAR.

Fuel Vent Fitting - Typical



COMBO FUEL FILL/
INTERNAL VENT

Currently, domestic EPA compliant fuel tanks vent fumes back into the fuel tank system. While the tank is filled, air displaced by the incoming fuel is vented through the fuel system charcoal canister.

Your vessel uses a combo type (internal vented) fuel fill. Both the fuel fill and vent occupy the same cavity under a protective cover. If fuel overflows through the vent the design forces it back into the fuel fill hose and tank. Be sure to tighten the fuel fill cap to prevent water and debris from entering the fill system.

A seasoned skipper will hear a distinct sound as the tank nears the “top out” or full mode and may see fuel overflowing back into the fuel hose through the vent. On select vessels not using an EPA fuel system there may be a separate vent fitting on the hull side. Periodically check this vent screen for debris and insect activity.

NOTICE

DO NOT OVERFILL THE FUEL TANK!
THIS HELPS AVOID ANY OVERBOARD
SPILLS WHICH MAY HARM THE
ENVIRONMENT.

Anti-Siphon Valve

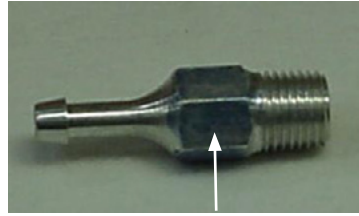

INTERNAL BALL/SPRING

The gasoline fuel tank feed line that runs from the fuel tank to an engine or generator fuel component uses an

anti-siphon valve. The valve is threaded into the fuel tank fitting at the feed line. The valve is pulled off its seat by fuel pump pressure as the engine is cranking or running. There is a ball and spring assembly inside the valve that is activated by fuel pump impulses. It allows a one-way fuel roadway to the engine or generator fuel system. It prevents fuel from siphoning out of the tank in the event of a fuel line rupture or disconnected fuel feed hose. When the engine fuel components stop the fuel from cycling the spring forces the ball against the valve opening to prohibit fuel flow.

Never remove an anti-siphon valve as it is a fuel system safety component. Also, never remove the ball and spring from the valve assembly. The anti-siphon valve requires no normal maintenance. Symptoms indicating possible valve problems may be fuel starvation at intermediate or high rpm or in extreme cases an engine that will not start. Contact your Regal dealer for further information.



WARNING

PREVENT INJURY OR DEATH!
READ AND UNDERSTAND THE
PROPULSION AND GENERATOR OWNER'S
MANUAL BEFORE ATTEMPTING
TO OPERATE THE VESSEL.

Fresh (Potable) Water System Overview

There is a fresh water supply on board known as a potable (drinkable) water system. The system includes a fresh water tank/sender, system manifold on/off valve, fresh water pressure pump/filter along with various hoses, connectors, city water pressure valve, faucets, and a monitor panel. We will review the main system components to aid in understanding how the system works.

Note that various components in the fresh water system require periodic maintenance to ensure the system continues to run effectively. Refer to the maintenance section and the various vendor instructions found in the owner's packet for further information.

Fresh Water Tank (Potable)

Normally the fresh water tank is manufactured from aluminum for increased strength and longevity. The tank utilizes a sender which senses the tank water level and displays an approximate amount on the fresh water section of the monitor panel.

Fresh Water Feed Hose

The fresh water feed hose runs from the fresh water tank to the fresh water pressure pump. It is a reinforced hose to prevent kinking.

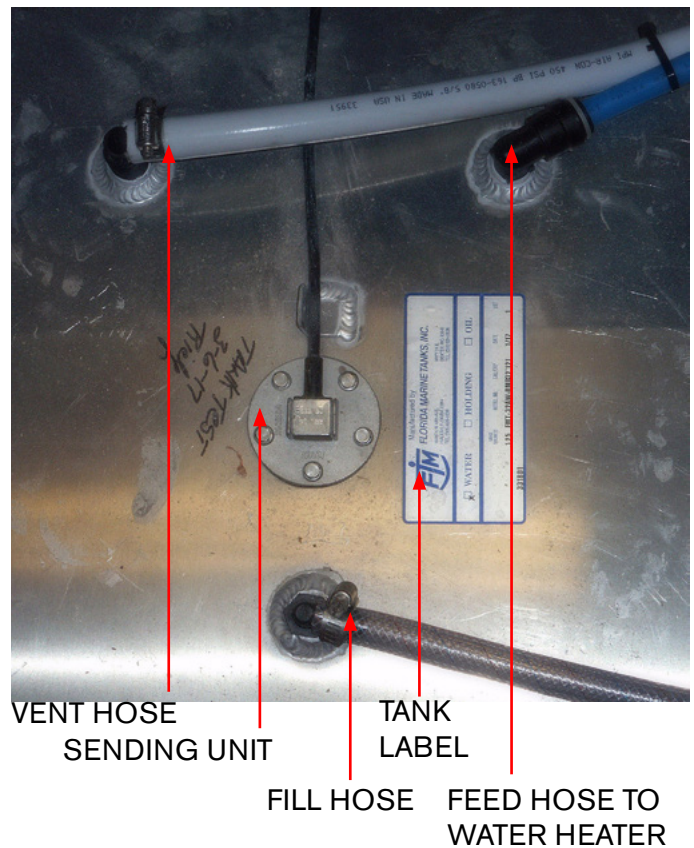

Sending Unit

Note there is a fresh water sending unit located on the tank top. This sending unit measures the amount of available potable water and sends a signal to the monitor panel.

When the top portion of the monitor panel switch is pressed the gauge shows the amount of water in the fresh water tank.

This reading is approximate as there is a margin of error involved. Always check the monitor panel fresh water level before each outing. The above components are visible by removing a floor access plate.

Fresh Water Tank (Fill Procedure)

Note that the water valve (open position) is used to fill the potable (fresh water) tank. This is the only time the open or “on” position is used. The valve is located inside the head vanity cabinet door. Turn the water system manifold valve to the “on”(in line) position. With your hose connected to the city water valve at the marina water faucet turn on the water.



When the fresh water tank is full (water exiting deck vent) or shown as a “full” display on the monitor panel disconnect water supply and be sure to turn the manifold valve to the “off” position.

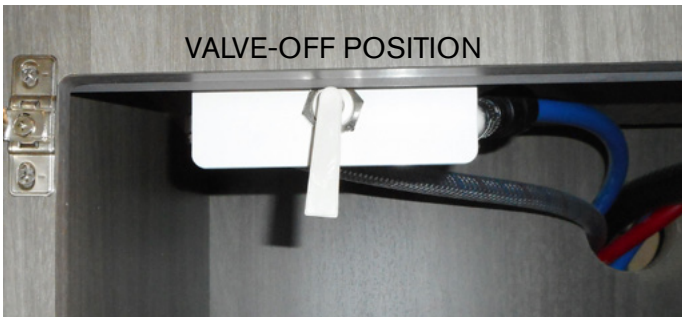

Do not energize the fresh water pressure pump during the water tank fill procedure as system water will keep recirculating and the tank may not fill up.

Fresh Water Pressure Pump (Typical)

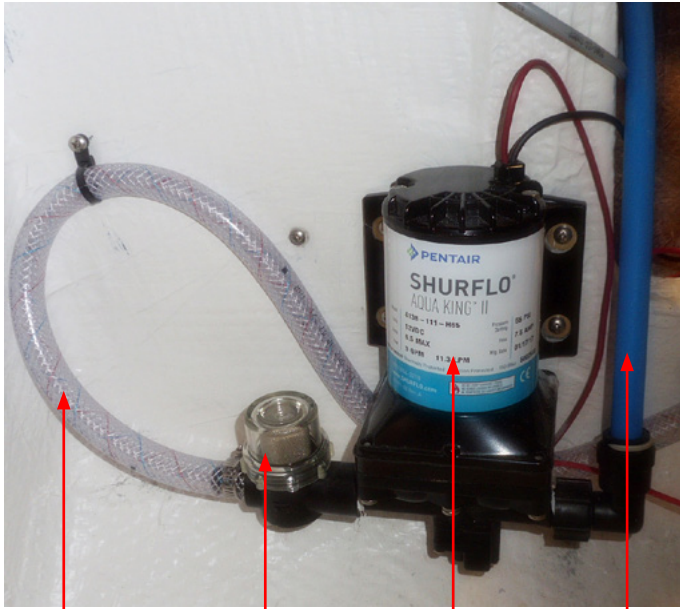

HOSE FROM TANK FILTER/STRAINER PUMP FEED HOSE TO WATER SYSTEM COLD SIDE

Operation

The 12 volt fresh water pump supplies potable water to various fresh water components on the vessel. At the main DC panel a 15 amp breaker controls the fresh water system. Also, the transom shower, faucets, and wash down components throughout the vessel are part of the fresh water system. The fresh water pressure pump is located under the forward bunk liner. The fresh water breaker switch must be activated for any of the above components to operate.

Periodically the water filter strainer located near the fresh water pump needs to be serviced. Inside the filter there may be a screen which needs to be cleaned of any debris and rinsed off with fresh water before reinstalling it.

A majority of these pressure pumps use a switch which disengages the fresh water pump after it reaches a predetermined line pressure. If the fresh water pump continues to run continuously it may be a result of the following:

- A faulty internal pressure relief valve
- A faucet on board not turned off
- A broken line or loose line connection

It is recommended that the fresh water pressure pump switch be in the “off” position when leaving your boat to help prevent damage should a leak develop in the cold water system.

NOTICE

AVOID COMPONENT DAMAGE!
NEVER RUN THE FRESH WATER PUMP
WITHOUT WATER IN THE FRESH WATER
TANK AS PUMP DAMAGE
MAY OCCUR DUE TO OVERHEATING.

Using Fresh Water System With Tank Only

This approach is mainly used while cruising without the ability to draw from a marina or public water supply by attaching a garden hose to the city water valve. Also, use this procedure when you are unsure of the purity and /or source of the water supply for drinking.

1. Verify through the monitor panel that the fresh water tank is full by activating the upper portion of the toggle switch.

2. At the helm switch panel activate the fresh water system switch. This will energize the water pressure pump to send fresh water from the potable water tank through the cold water lines terminating at the various faucets and related components.

3. Open a faucet. Water pressure should be present. Opening the faucet for a few seconds will purge any air in the system especially in cases where the fresh water tank has run out of water. When water is running at a faucet it is not unusual to hear the water pump activate as it is trying to build up the pressure required in the system. Soon after the faucet is turned off the fresh water pump sound will end indicating the fresh water system is now up to specified system pressure.

Note not to run pressure water pump with system dry as water pump component damage may occur.



Using Fresh Water System With City Water Valve

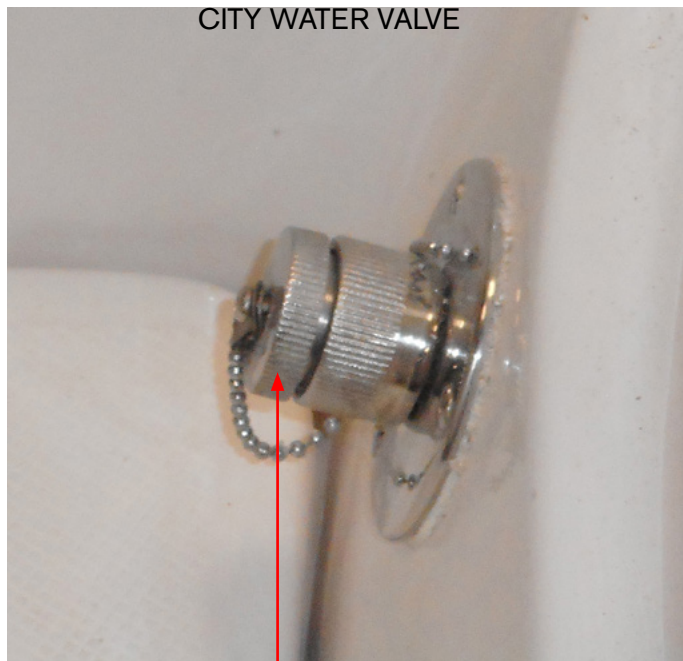

TURN COUNTER CLOCKWISE TO OPEN

Use this procedure when at the dock or mooring.

1. After verifying that the water supply is safe for drinking find the city water valve at aft transom. Remove the cap and inspect screen for debris.
2. Connect a white colored kink resistant garden hose to the city water valve. Turn on the marina water supply and check for leaks at the connection. White garden hoses are the ones rated for fresh water supply verses a regular garden hose that normally leave a rubber smell in the water supply.
3. Repeat steps 2 and 3 as indicated on the last column since the process at this point duplicates itself.

Note that the city water valve protects vessel water system by limiting incoming water pressure to 35 psi's.

Using Fresh Water Wash Down



Inside the starboard deck locker is a wash down faucet. The wash down system uses city water when at dock side through the city water valve and the fresh water pump does not activate as the city water pressure in the system is greater than the pump pressure.

Of course at sea this deck wash down system is using potable water. Always try to find hose and connections such as a nozzle that use neoprene covers to provide protection from gel coat damage in case the nozzle drops on the deck.

In freezing climates, be sure to add the appropriate anti-freeze in the system through the water tank vent hose at the deck rope locker.

Sanitizing Fresh Water System

It is recommended to sanitize your fresh water system at least annually or more often when odors are detected. Contact your closest Regal yacht dealer for more information. He has the tools and factory trained personnel to preform this procedure.

1. Flush entire system thoroughly by allowing potable water to flow through it.
2. Drain system completely including water heater.
3. Fill entire system with a chlorine solution having a strength of at least 100 parts per million, and allow to stand for (1) hour. Shorter periods will require greater concentrations of chlorine solutions. See the table.

TABLE 1 – CHLORINE CONCENTRATIONS

Amount of chlorine compound required for 100 ppm solution

Solution (Gallons)	Chlorinated Lime 25% (ounces)	High Test Calcium Hypochlorite 70% (ounces)	Liquid Sodium Hypochlorite 1% (quarts)
5	0.3	0.1	0.2
10	0.6	0.2	0.4
15	0.9	0.3	0.6
20	1.2	0.4	0.8
30	1.8	0.6	1.2
50	3.0	1.0	2.0
100	6.0	2.0	4.0

As a rule of thumb quick reference without the use of the table to reach the recommended proportions use a quarter cup of household bleach for every 15 gallons of water in the fresh water tank. Let water tank sit for 30 minutes for the bleach to mix with the water completely and thus be disinfected.

4. Drain chlorine solution from entire system.
5. Flush entire system thoroughly with potable water.
6. Fill system with potable water.

Winterizing Your Vessel Fresh Water System

Note that In freezing climates make sure the fresh water system is winterized to prevent damage to hoses and components.

Follow the instructions in the winterizing chapter depending on your system type or contact your closest Regal yacht dealer since only special alcohol based products like "Winter Ban" are to be used in the system.

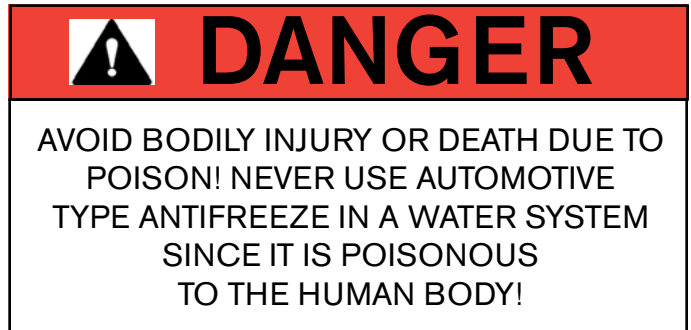

Hot Water Heater

RESET BUTTON

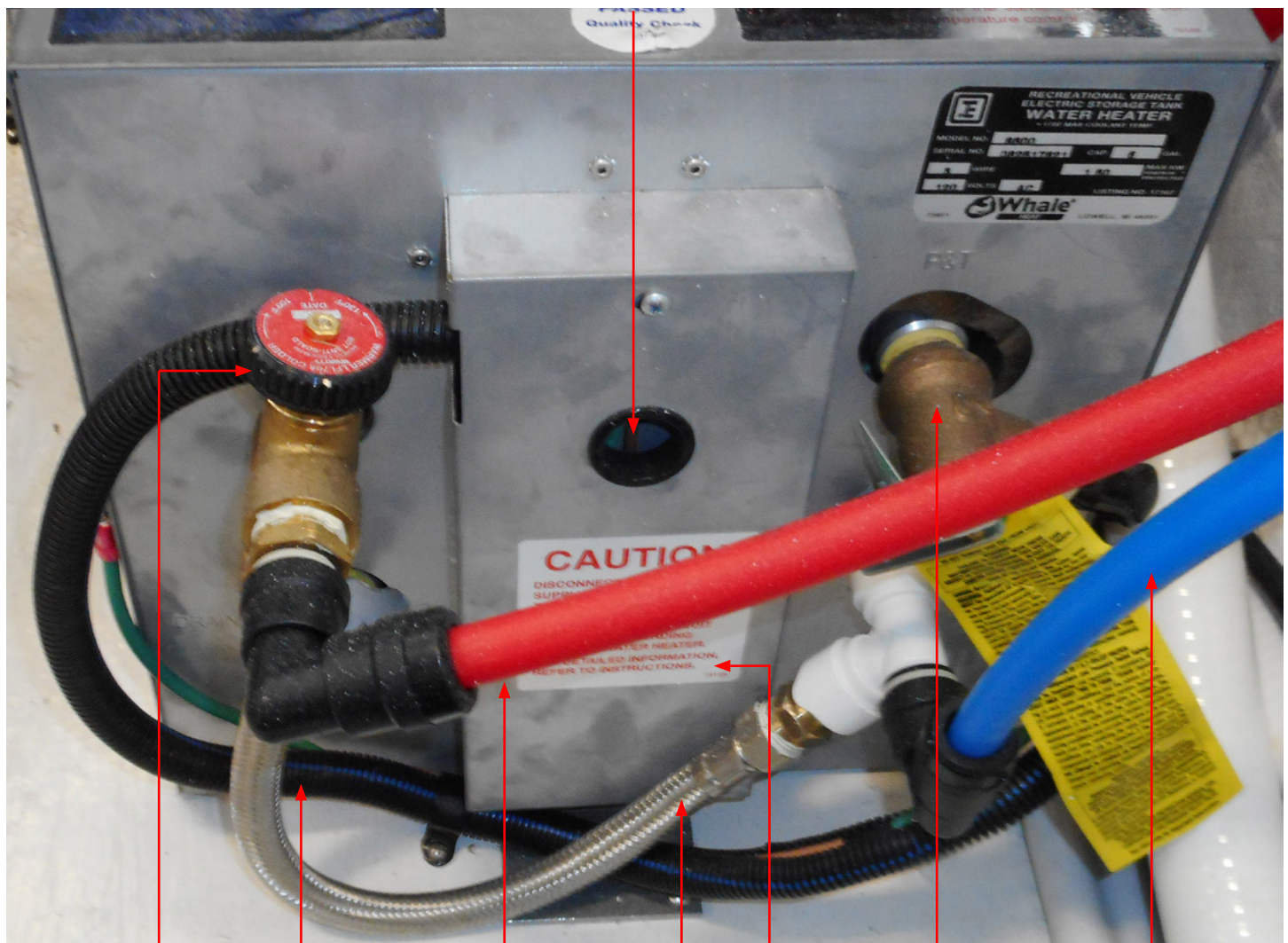

TEMPERING VALVE

HOT WATER FEED HOSE

ELEMENT

T & P VALVE

COLD WATER TO TANK

AC POWER SUPPLY

TEMPERING VALVE COLD WATER FEED HOSE

Overview

The ship's 6 gallon water heater requires 120 Volts AC and the unit is located in the sump (bilge). The water heater 15 amp breaker is located on the main ship's AC panel. The unit draws cold water from the fresh water tank and is heated by using dock side power or by the generator at sea. *Note that the water heater provides a limited hot water capacity. People on board need to be aware of that fact. It pays to conserve!*

Operation

The photo above displays key players in the operation cycle of the hot water heater. The cold (blue) water line transports water from the fresh water tank to the aft tee on the water heater. Water runs through the tank via a tempering valve and exits the hot (red) line to the hot side of each sink and to the head shower mixing valve. The cold water feed hose lets water enter the tank through the tempering valve to regulate hot water to a maximum temperature of 125 degrees.

Notice the brass T & P valve in the photo. This is a safety device for the hot water heater. Your home hot water heater uses a similar product. Should water reach an unsafe temperature or excess pressure a lever opens to exit the water and steam through a hose overboard. Most valves will activate with 150 pounds per square inch and water temperatures exceeding 210 degrees. The T & P valve lever should be activated manually once a year to ensure hot water and steam will vacate through the discharge hose.

The tempering valve is attached where the hot water exits the hot water heater for travel to the sinks and shower. You can identify the valve by the red knob on top. Make a note of the tempering valve setting and make sure it does not change. The purpose of the tempering valve is to regulate the outgoing heated water to a maximum of 125 degrees. If the output water is of a higher temperature than specified the valve mixes cold water to decrease outgoing water to safe levels through the stainless steel mesh hose.

There is an element located inside the rear cover of the hot water heater. This is the component that heats up the water inside the water heater. The element requires that it be immersed in water or it will quit functioning. There is a reset button for the element which can be accessed through the hole at the rear casing. Push in to reset the button.

 **CAUTION**

PREVENT HOT WATER HEATER DAMAGE!
NEVER ACTIVATE THE BREAKER
WHEN THE HOT WATER HEATER
IS NOT COMPLETELY FULL OR
THE ELEMENT WILL BE DAMAGED!

Fresh Water System-Helpful Hints

1. Fresh water pressure pump cycles on and off.

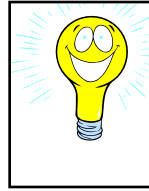

Normally this type of action indicates a water leak in the system. Check all fresh water system related equipment on the deck, cabin, and engine compartment for leaks. Do not forget wash down equipment including spigots. Look for puddled or dripping water.

2. Using potable water system the water pressure is weak. Check the fresh water pressure pump filter for debris. Also, make sure the potable water tank level is sufficient at the monitor panel.

3. Water at sink or shower is hammering and has air bubbles in it. Check for air leaks in the system along with low water levels in the potable water tank.

4. Water is backing up in the shower. Find the shower sump pump. If it is full of water even when running there may be a clog at the pump screen. Clean as needed.

5. There is no water at any of the fresh water related equipment such as faucets, showers and wash downs. Check to make sure the fresh water pressure pump breaker is on. Also, check the fresh water monitor for tank levels

6. The water system has a bad odor. Use the fresh water pressure pump to drain the fresh water system. Do not drink the water as it may be contaminated. Sanitize the water system.

7. No hot water. Check panel breaker. Check for popped tank element breaker. Reset as needed.

Waste System (Typical)

Overview

This section covers the main components of the standard waste system. Note that your vessel may have other components that are not covered in this section. Refer to the vendor owner's manual located in the owner's information package your closest Regal dealer for details regarding optional equipment.

The main standard components of the waste system are the toilet, holding tank, monitor panel along with hoses, fasteners and sea cocks. We will explore each in this section.

Typical Head (Toilet) System

The onboard style head system features a vacuum type toilet using minimal water. It normally features vitreous china bowls, minimal maintenance, easy cleaning and a wall switch keyboard.

The toilet is powered by 12 volt DC current and is controlled by a 30 amp breaker located at the main ship's DC panel.

Under normal conditions, the head system operates from the onboard freshwater tank. If dock side water is being used the toilets still draw water from the freshwater tank.

A Few Notations About Marine Toilets

Only human waste and toilet paper should be put in the toilet. Never flush foreign materials such as paper towels, pre-moistened wipes, condoms, feminine hygiene products, dental floss or household garbage down the toilet.

- Always disconnect the dock side water system if boat is left unattended to avoid property damage due to leakage.
- Refill the toilet as soon as possible after emptying the bowl to prevent objectionable odors.
- Use only RV-Marine toilet tissues that disintegrate rapidly. Do not use household type tissues.
- If repairs are needed, use only a trained and qualified marine technician or electrician.



VACUUM STYLE
TOILET

TOILET FLUSH
SWITCH

Operating Vacuum Style Toilet

To use toilet first make sure the 12 volt DC breaker is activated at the main panel. Remember even though you are using dock side water the heads draw water via the fresh water system through the potable water tank.



The wall control switch is used to add water to the bowl and to flush the toilet. Select cycle information is noted here. For more complete information, refer to the toilet vendor information located in the information packet.

1. To add water (est. 17 ounces each cycle) to the bowl press the add water button momentarily and release. The system prevents overfilling the bowl.

2. To flush the bowl press the flush button momentarily and release. The attached bowl motor will macerate the waste and flush it. The cycle ends with a small amount of water being added to the bowl to help prevent odors. This completes the minimal water usage flush cycle.

Wall Control Panel Blue Backlighting Description:

- The holding tank icon in the lower right hand corner of the control panel is not lighted. Toilet system is off or not receiving power.
- The holding tank icon is normally green. This means the holding tank is less than full.
- The holding tank icon is red. The holding tank is full or near full with the flush lockout (prevents Flush operation when holding tank is full) activated.
- Tank icon flashes.
- Sleep mode (non-use for 8 hours) causes the lights to go out. Pushing the fill or flush button momentarily will return lighting cycle.

Single Flush Override of Flush Lockout

1. If the holding tank is full the flush lockout cycle will not allow the bowl to be flushed and the flush button will be lighted red.
2. For emergency use only the flush button can be held for 8 seconds and a flush will occur. This can be accomplished because the full sensor connected to the holding tank is usually placed a bit below the actual full capacity of the tank. Flushing more than 5 times using the override feature may force waste into plumbing system. Regal is not responsible for damage to equipment, injury or death due to overflow of waste when flush lockout is overridden.



CAUTION

POSSIBLE OVERFLOWING OF THE WASTE HOLDING TANK CAN OCCUR DUE TO USING THE SINGLE FLUSH OVER-RIDE FUNCTION. FOR EMERGENCY USE ONLY.

Monitor Panel



KEY GAUGE MOMENTARY SWITCH
PUMP-OUT BUTTON

The monitor panel is found at the cabin stairway above the ship's main AC panel. It is a multi-function component but also offers a check for the potable water and waste tanks. To check the waste tank black water level press the lower part of the momentary switch shown in the above photo and check the gauge.

It will help you determine when to pump out the waste tank. The top segment of the switch measures the fresh water tank level. Check levels before each cruise. Pump out waste and fill potable water tank as required.

Overview

The waste water system on your vessel is located in the sump. The system features a pump-out fitting mounted on the deck labeled waste.

A monitor panel shared with the fresh water system displays the waste tank level when activated. Press the lower portion of the switch and read the gauge waste level. The waste tank can be pumped out at select marine facilities. Normally a hose is attached to the deck waste fitting and the tank waste is then pumped into a dock side facility storage container.

After the pump out procedure it is always a great idea to use a garden hose to rinse the pump out hose before recapping the waste fitting. This will help keep residue from building up in the inside of the waste hose.

Waste Tank Description-Typical

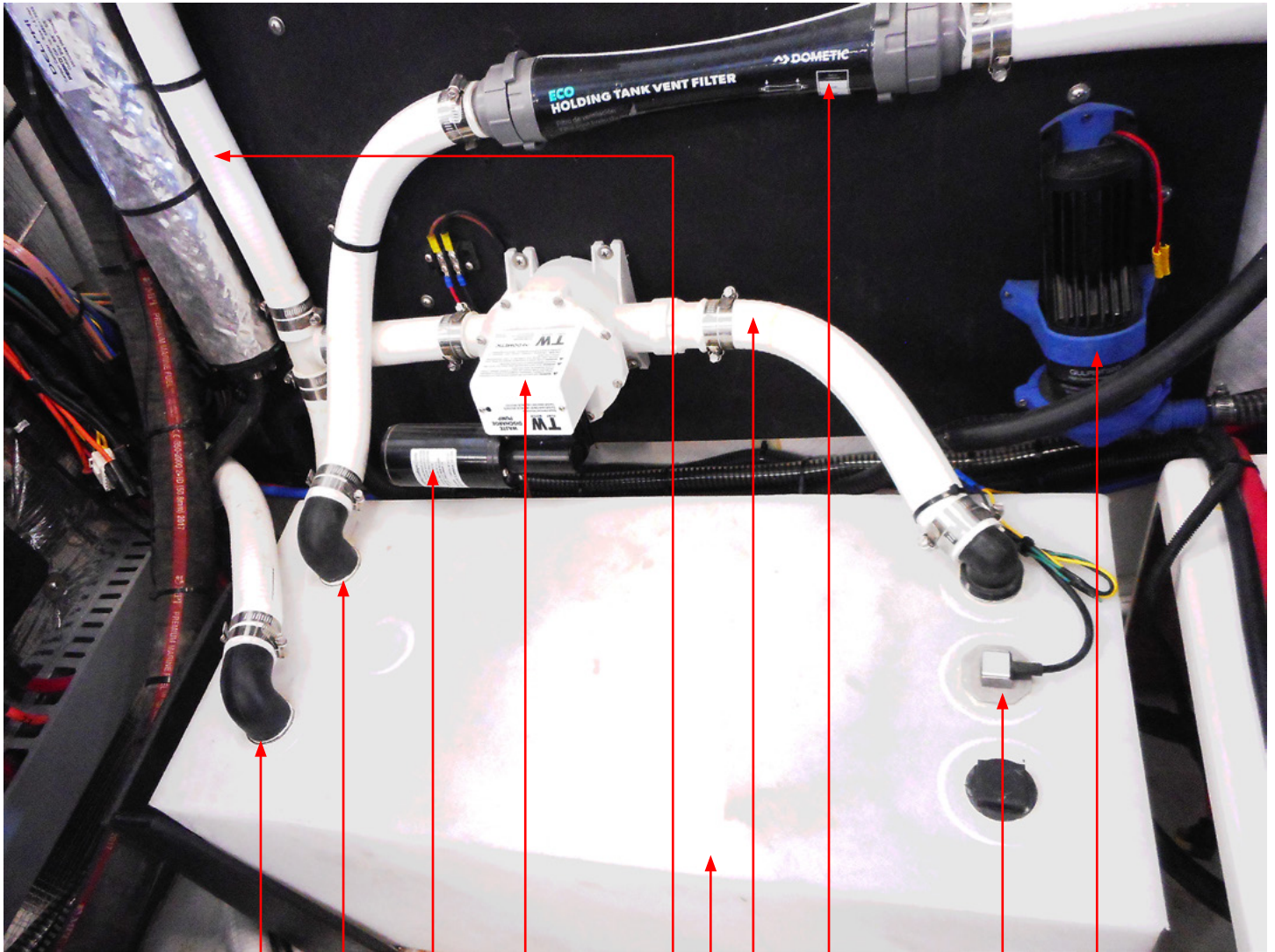

HOSE FROM TOILET

VENT HOSE

MACERATOR

OVERBOARD DISCHARGE
PUMP

HOSE TO DECK FITTING
FOR PUMP-OUT

WASTE TANK- 29 GALS.
CAPACITY

HOSE TO PUMP OUT/ OPT.
OVERBOARD DISCHARGE

WASTE SYSTEM FILTER

HOSE IN/OUT & PUMP FOR
SHOWER BOX

SENDER

Overboard Discharge

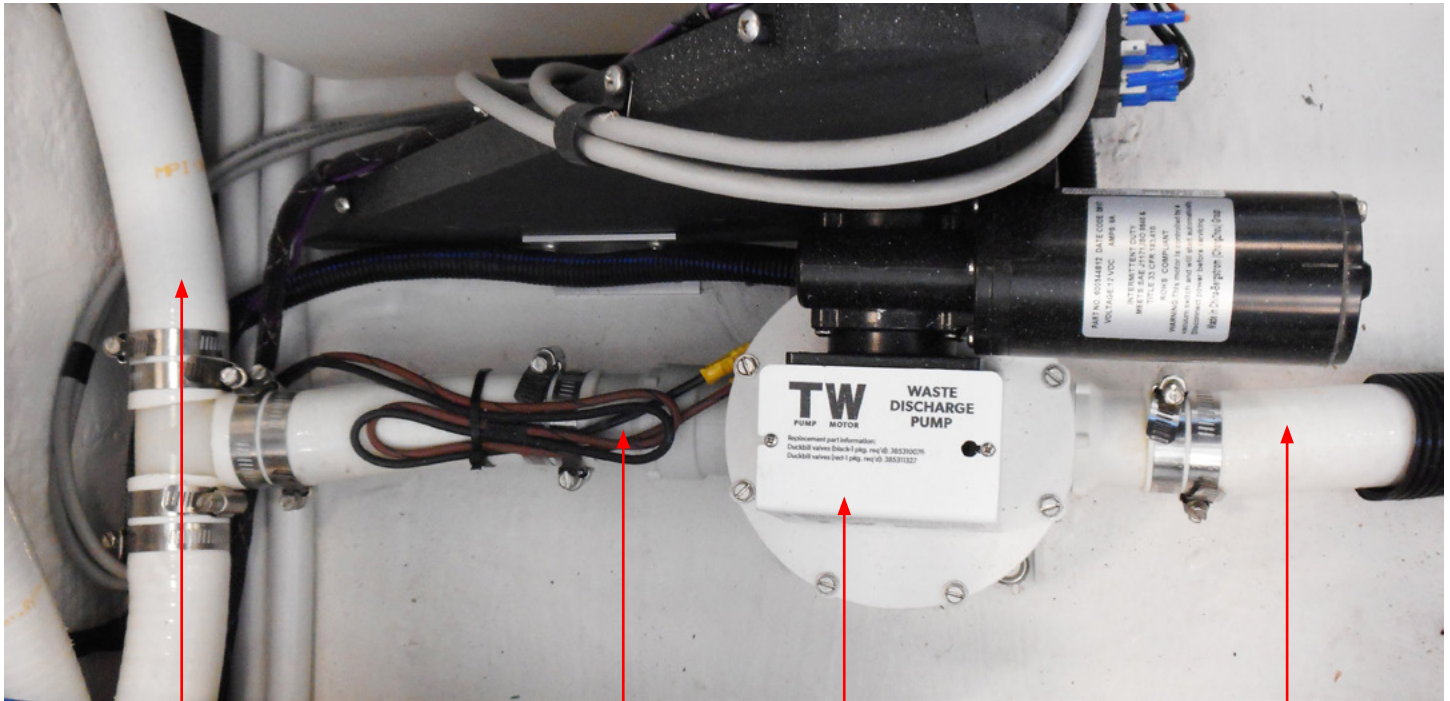

HOSE-TANK TO PUMP OUT HOSE TO OVERBOARD DISCHARGE PUMP MACERATOR DISCHARGE PUMP HOSE TO SEA COCK

Operation

As an option the vessel may be outfitted with an overboard discharge system including macerator. Waste will exit the hull through the macerator sea cock turned to the open position. **Always determine you can legally pump overboard before discharging overboard.** Notice there is a key switch and red button on the monitor panel. Turn the key to the “on” position. Next, press the red button and hold it as the macerator pumps the waste through the sea cock. After pumping check the waste portion of the monitor panel as the gauge should show empty.

The reset breaker on the monitor panel protects the power to the gauge. The macerator grinds up the waste and sends it through the hull bottom via the *open* macerator sea cock.

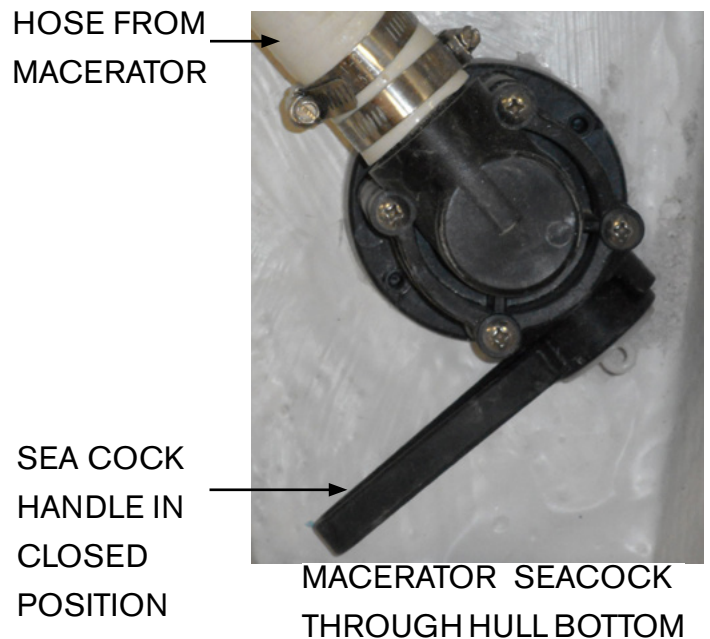

The macerator breaker is 10 amps and is located on the ship's main DC panel. After pumping out, the sea cock handle must be turned to the closed or "off" and tie wrapped.

Check for all local and state laws regarding pumping overboard domestically before attempting to open the hull bottom sea cock as there may be stiff fines for pumping illegally. It is legal to pump overboard outside the United States 3 mile limit.

Periodically check all hose clamps for tightness, hoses for cuts and abrasion and that all components are fastened securely.

Vent Filter



The waste (holding) tank filter is in-line between the holding tank vent and in this case a transom exit (exit hose missing here). As the holding tank fills up with waste it gives off odors. The vent filter breaks down the odors as they travel out the aft portion of the transom.

The waste filter is "customer friendly" as it is designed with a union at each end for changing out the cartridge filter. The unions unscrew counter clockwise for serviceability. It is recommended to change the filter yearly, normally at the end of your boating season. Mark the change date on the filter or on your vessel maintenance calendar.

It is a good habit to carry an extra filter on board. For further information on availability contact your closest Regal dealer or maine retail outlet.

Shower/Head Information



The shower pan features a removable teak floor insert. Under the insert is the shower strainer/drain. To remove the insert, lift on the upper ends as it is secured with a velcro style adhesive. At this point you can clean the shower floor and strainer of debris and reinstall the teak panel.



Note that behind the starboard aft state room locker is an inner panel. Once opened it provides access to shower, toilet, and sink plumbing tee fittings.



The head/shower features a 3 switch panel. Note that when activated a blue icon is lighted. Their function is as follows:

1. Overhead light switch controls the LED ceiling fixture.
2. Indirect light switch controls the LED stripe accent lighting.
3. Power vent controls the head fan.

Shower Box

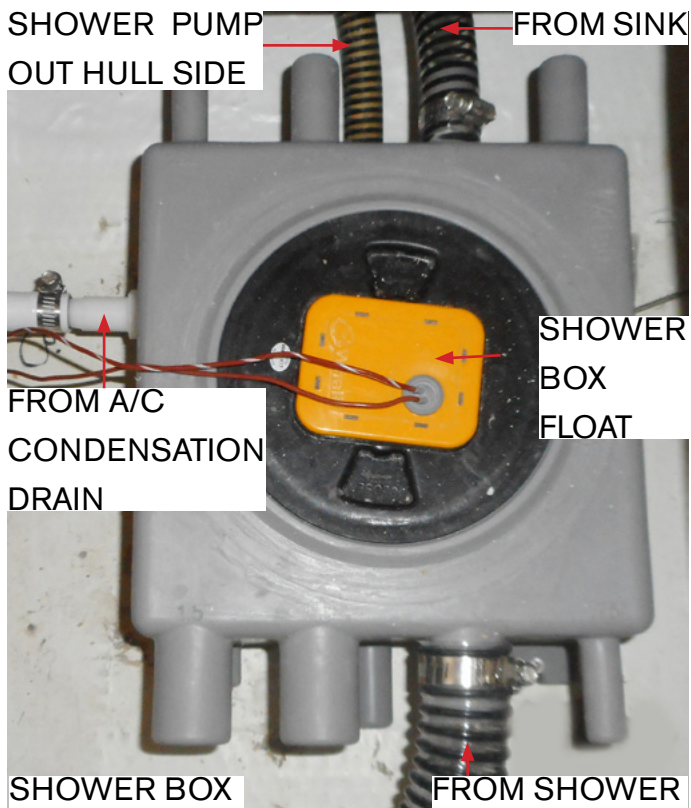

The shower box is a collection and distribution point for the majority of the water used in the vessel's sinks, shower, and A/C system. The shower box is located under the aft stateroom floor access. This used water is pumped overboard traveling from the shower box to a hull side fitting.

Periodically check the shower pump inside the shower box for debris buildup at pump grate.



As the shower pump fills the float switch shown above it activates a pump which sends the gray water to the holding tank (gray water option vessel only) or overboard on all

other vessels.

Transom Thru Hull Fittings

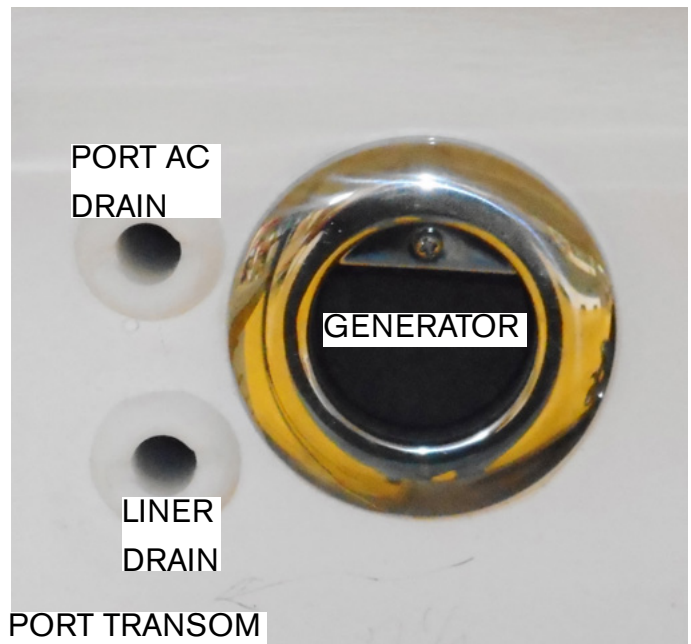

Always check generator outlet after starting unit. If no water exhausting turn off generator immediately and check for fault.

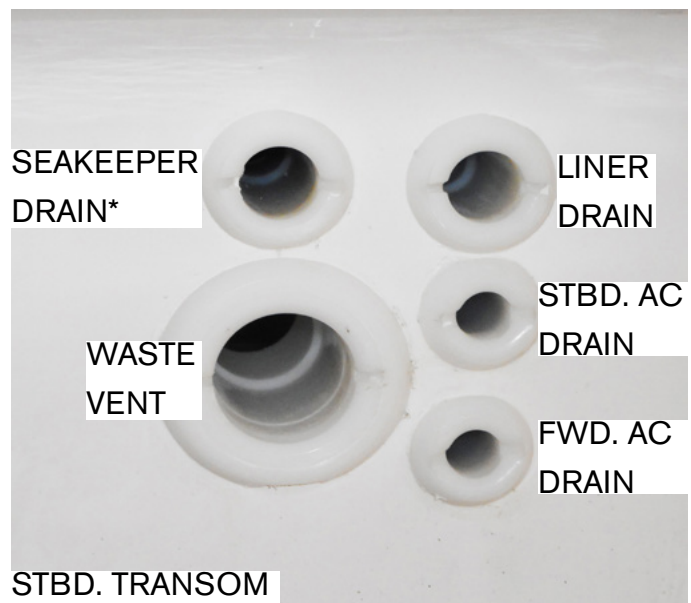

***Optional**

Always check Seakeeper outlet after starting unit. If no water exhausting turn off component immediately and check for fault.

Trim Tabs



If installed, trim tabs are located on the lower outside hull section of the transom. Water is deflected and redirected as the trim tabs are raised and lowered from the starboard helm located trim tab switch. This change in water flow creates upper pressure under the tabs, and raises the stern. When the stern rises the bow is lowered. Lowering the port tab will cause the port stern to rise, making the starboard bow lower. Lowering the starboard tab will cause the starboard stern to rise, making the port bow lower. The pressure originates from a pump and valve system at the aft bilge.

When used with the engine power trim a fine tuned ride can be achieved. The trim tabs will compensate for uneven weight distribution, listing, water conditions, and other factors that cause inefficient operation. Remember, that trim tabs are trimming the hull while power trim is trimming the outboard or stern drive units.

Obtaining A Trimmed Position

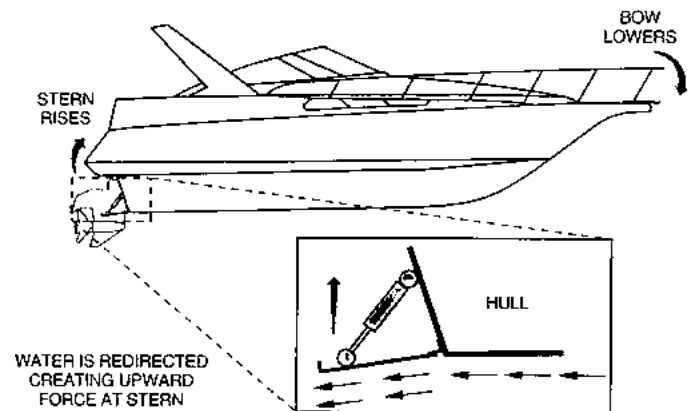

Your vessel will reach a planing position at a specific speed. This speed is determined by bottom design, weight distribution, water conditions, and on board equipment. As the throttle is advanced the stern squats and the bow rises initially. The trim tabs allow your boat to plane at a slower speed than natural conditions allow. *Note a stern drive example above.* In short bursts both trim tab rocker switches are pushed simultaneously in the “bow down” position which causes the trim tabs to move down. As the boat breaks over the bow high attitude the boat speed accelerates and visibility increases.

If the boat is over-trimmed, it will plow the bow and the boat will lose maneuverability. If this occurs, simply short burst the “bow up” trim tab rocker switches simultaneously.

In the “learning curve” process, press the tab switches in half second bursts. You will notice a slight delay from the time the switches are pushed until the boat reacts depending on vessel speed. You will know after awhile the optimum planing angle and speed.

When running in heavy seas press the “bow down” position which will assist the vessel to cut through the waves. This will produce a drier and more comfortable ride. In a following sea run the tabs in a fully retracted angle for maximum drive response. Sometimes you can watch the bow spray or stern wake and the rooster tail (mound of water produced by outboards). In a bow up position the spray is far aft to the hull, the wake is high and the rooster tail is high.

When trimmed or in the bow down position, the bow spray is farther forward, the wake and rooster tail are smaller, and positioned further behind the vessel. Also, when trimmed you will notice that tachometers show an increase in rpm’s.

Rectifying A List

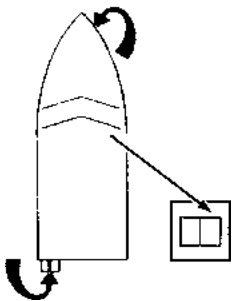

Your vessel can use the trim tabs to rectify a list. The trim tabs adjust the boat’s attitude in the direction the helm rocker switch is pushed.

If the port bow is high, push the left-hand “bow down” direction on the dash rocker and the port bow will lower. If the starboard bow is high, push the right-hand “bow down” direction and the starboard bow is lowered.

Using Power Trim With Trim Tabs

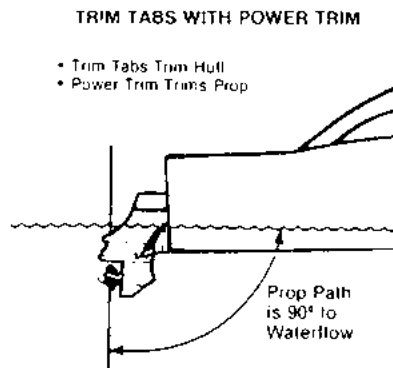

Adjust the trim tabs to achieve a planing attitude. Use the power trim to position the prop path parallel to the water flow. At this point the trim tabs

may need a fine adjustment.

One advantage of the trim tab system is that they allow trimming of the hull while the power trim results in trimming the props.

Note that Illustration shows stern drives vs. outboard drive units.



The indicator lights display the relative position of both port and starboard tabs at all times.

CO Detectors



The most common forms of CO on board vessels are petrol engines/generators and if applicable, propane heating and cooking devices. Note: Even if your vessels propulsion system is diesel based follow the CO precautions. Also, remember that a vessel moored next to you may be a CO poison contributor.

Never operate these devices when people are sleeping. A slight amount of CO in the human body over several hours causes headaches, nausea and symptoms close to food poisoning, motion sickness or flu. High concentrations can be fatal quickly.

Carbon monoxide known as CO is indeed the silent killer. It is a by-product of combustion. CO is invisible, tasteless, odorless and is produced by all combustion engines along with many heating and cooking appliances.

How System Works

The CO detector uses a mini computer to measure and accumulate CO levels. Using the principle of “time weighted averaging” the detector monitors CO concentrations, temperature, humidity and time to calculate COHb levels. To explain COHb, our bodies prefer to absorb CO to oxygen and COHb is the absorbed ratio stated in a percent.

If the detector senses high levels of CO the alarm will sound in a few minutes. If lower levels are sensed, the detector will accumulate the data and sound an alarm when the appropriate level is reached. Read and understand the CO owner’s manual in the owner’s information pouch.

The CO circuitry works to its best performance when continually activated plus it accords advanced warning when entering an area high in CO.

The CO detectors operate using 12 volt DC power and over current protection inside the battery management box in the engine compartment.

The test cycle should be activated weekly. Simply press the button. Refer to the CO detectors owner’s manual for an explanation of the test cycle indicators. Note that the green light will flash every 180 seconds which is normal.

Note that constant exposure to hot and cold temperatures may reduce battery life.

CO Detector Notes

1. The date of manufacture is embossed at the bottom of the detector. Replace unit after 7 years even though battery life is longer.

2. Test weekly. Clean face weekly. Do not use solvents.

3. When CO event occurs alarm beeps 4 times, 5 second pause. Repeats.

4. End of life cycle is 1 beep every 60 seconds. To deactivate unit at life's end hold button down for 1 minute. Red and green LED lite up. Press button 5 times. Red and green LED flash, horn beeps. Unit is deactivated.

5. The batteries are not replaceable. Do not remove them from the unit.

6. The detector performs a self-diagnosis of critical components every 180 seconds. Should a major component fail the unit enters a fault in which both visual and audible indicators activate.

7. If an alarm sounds move everyone to fresh air immediately. This indicates a rate of 10% COHb has been reached. Call your emergency services. Do not re-enter the vessel until emergency personnel have arrived.

Your alarm reactivates within a 24 hour period Call a qualified technician to inspect the vessel. Note that the CO detector will clear when the CO concentration has dropped below 70 ppm (parts per million).

8. Avoid spraying cleaning liquids directly on the alarm.

9. Clean detector face weekly by wiping surface of alarm with clean soft lint free cloth.

Ventilation System

Your vessel uses a natural and powered ventilation system to exchange air in the engine compartment. The cowlings for the intake and exhaust ventilation system is on the port and starboard aft deck.

In the natural system fresh air enters through a set of intake ducting and any contaminated air exits through the exhaust ducting. Notwithstanding, both gas and diesel stern drive engines need this air supply to run efficiently. This includes stern drive vessels where the engines are mounted in the bilge and outboard vessels using a generator in the bilge.

In the powered segment of the ventilation system exhaust hoses exit air in the lower 1/3 of the bilge as this is where any contaminated fuel fumes would be found. These hoses exit air from this area through a powered blower. There is one blower provided for every engine source including the generator.

Note that outboard vessels use a blower for the generator only as it is the only engine source located in the bilge.

Never block the cowlings as engine compartment air would be restricted and would effect engine and generator efficiency. Periodically visually check the cowlings for insect nests or foreign debris that may block the ducts.

Typical Entertainment/Electronic Components



Overview

Your yacht features a variety of standard components that provide both visual and audio entertainment. In addition, there are optional systems that are noted in the following pages. Regal reserves the right to add, delete, or change both standard and optional components at anytime without notice.

Please refer to the individual owner's manuals and the technical section (schematics) for further entertainment system information.

The generator (at sea) or the dock side cord (at mooring) must be activated/plugged in to supply AC voltage to the HDTV monitors and HDMI splitters.



WARNING

PREVENT INJURY OR DEATH
DUE TO FIRE OR EXPLOSION!
RUN BLOWER AT LEAST 4
MINUTES BEFORE STARTING ENGINES
OR GENERATOR.

Overview

The system features an integrated Wi-Fi, touch screen one-piece glass display and digital signal processing (DSP) that expands the sound quality to another level by tuning yacht sound areas to individual speaker profiles and amplifiers.

With the Fusion link app your yacht has been initialized by the factory with the DSP profile to provide a perfectly tuned entertainment system on board. Bottom line you can enjoy the music you desire to hear on the water customized for your ears and the environment.

You can use the glass cockpit chart plotter Media button to control the stereo head. This of course is possible due to the NEMA 2000 communication system installed on your vessel. Also, you can listen to your music over the television.

The chart plotter should automatically detect the media player when it is first connected. You can play media from sources connected to the media player and sources connected to the NMEA 2000 network. Refer to your chart plotter manual under Media Player for more information.

The stereo unit features AM, FM, Bluetooth and USB connectivity which support numerous media devices.



To power up the stereo do the following:

Energize the electronic dash switch. Activate the plotter power button. Choose Media at home screen. Then choose Fusion. Use the basic start-up guide as needed to play music and set up source devices.



Stereo Controls

Basic Start-Up

1	Dial	<p>* Turn to adjust the volume</p> <ul style="list-style-type: none"> ▪ When adjusting volume, press to switch between zones. ▪ When adjusting volume, press & hold for at least 1 second to adjust the sub woofer levels. ▪ On a tabbed screen, press & hold for at least 1 second to switch the tab. ▪ Turn to move through the menus or adjust a setting. ▪ When in a menu, press to select the highlighted option.
2	Source Icon	<ul style="list-style-type: none"> ▪ Press to change the source.
3		<ul style="list-style-type: none"> ▪ Select to open a menu for the current source. Not available on all sources.
		<ul style="list-style-type: none"> ▪ Select to open the stereo settings menu
		<ul style="list-style-type: none"> ▪ Press to turn on the stereo. Press to mute the stereo. Press and hold to turn off the stereo.

Playback Controls

	* Select to pause media playback.
▶	<ul style="list-style-type: none"> Select to play media or resume media playback.
◀◀	<ul style="list-style-type: none"> Select to skip to the previous track, when using an applicable source. AM, FM, or SiriusXM source. <ul style="list-style-type: none"> *Select to tune to previous station or preset. *Hold for faster tuning (manual mode only). DAB source: Select to return to previous DAB station in the ensemble. When you reach the beginning of the new ensemble, the stereo automatically changes to the last available station in the previous ensemble.
▶▶	<ul style="list-style-type: none"> Select to skip to the next track, when using an applicable track. AM, FM, or SiriusXM track. <ul style="list-style-type: none"> *Select to tune to the next station or preset. *Hold for faster tuning (manual mode only). DAB source: Select to advance to the next DAB station in the ensemble. When you reach the end of the current ensemble, the stereo automatically changes to the first available station in the next ensemble.
MA*	<ul style="list-style-type: none"> On the AM, FM, or DAB source, select to cycle through the tuning modes (auto or manual) and presets (when 2 or more presets are saved). Press and hold to save the current station as a preset.

+	<ul style="list-style-type: none"> On the Aux or SPDIF source, select to increase the gain for the connected source.
-	<ul style="list-style-type: none"> On the Aux or SPDIF source, select to decrease the gain for the connected source.

For more information refer to the Fusion® quick start manual in your owner's information sachet and the Garmin "glass cockpit owners manual if component is installed.

Remote Stereo Control- Earlier Vessels



If installed the stereo remote control may be mounted top side (fore-deck) where it makes controlling the main cabin unit easier.

It is a plug and play device and uses the same function buttons and rotary encoder as the helm head unit. It features the ability to select various speaker zones on the vessel. Refer to the Fusion owner's manual for more detailed information.

NMEA 2000 Network

The NMEA 2000 is a communication system between electronic components. There is a main trunk called a “backbone” (See illustration). There is normally a NMEA backbone located behind the helm and at the starboard coaming locker near the helm seat. As electronic components are added to the system a cable is attached to the backbone from each component so that component can talk to the other equipment on the backbone. It is kind of like branches being connected to the trunk of a tree.

There is a yellow cable attached to the center of the backbone that is the 12 volt power supply. When the electronics switch is activated the backbone is energized thru the yellow cable.

A typical feature in using a NMEA 2000 network is the Fusion® entertainment media can be accessed and controlled from the Garmin glass cockpit chart plotter system at the helm.

Note that a terminator cap is installed at the end of the backbone.

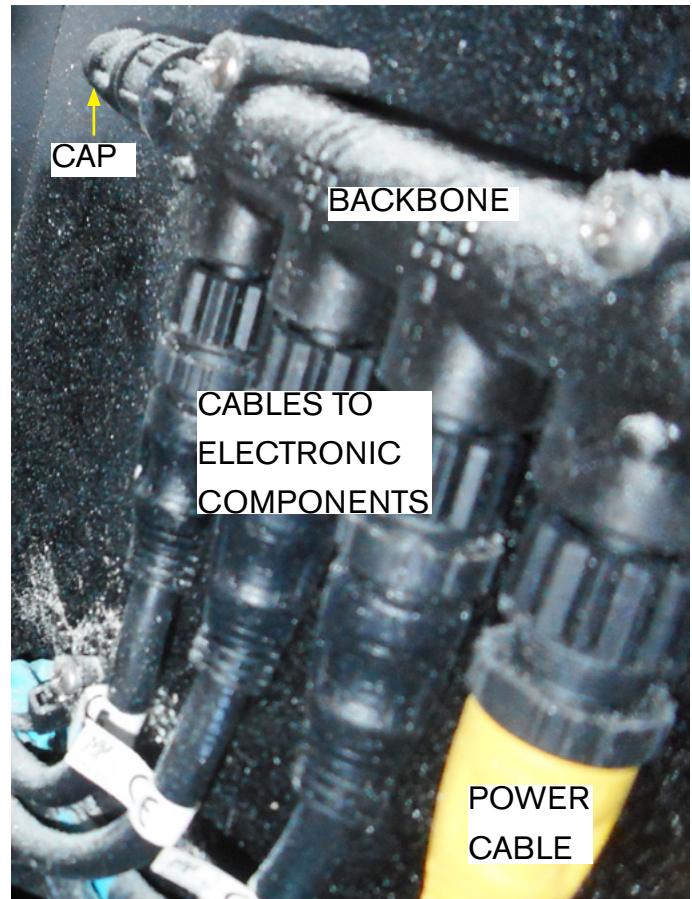

TYPICAL NMEA 2000 SYSTEM

Television-HDTV



The on board television monitors deliver true HD (high definition) reception and are multi-functional with other entertainment components.

HDTV's may be located in the forward and aft staterooms, salon and patio.



Select TV splitters are connected to a Blu-ray player which is located near the helm seat inside the side storage locker.

The remote controls are used to switch between devices/systems. HDMI 1 or 2 (depending on settings) is used to view the plotter information via the TV screen.

Note to access the TV splitter's and HDMI units pull the starboard side of the aft stateroom television to the left. It is hinged and will permit access to select TV components in the locker behind the television. Before servicing any of the locker components read and understand the label on the following page.

Television Antenna Switch

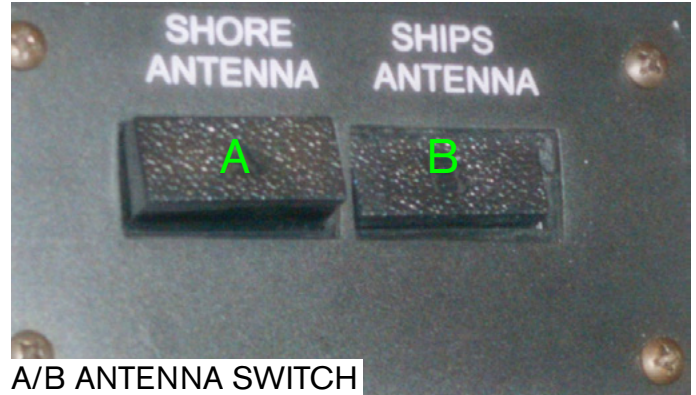

The TV antenna switch features 2 buttons labeled A and B to choose the desired antenna signal source. It is located at the atrium AC-DC panel I
Note: Activate the TV antenna breaker. Follow the instructions below.

At Dock Side- After the television coaxial cable is plugged into the vessel coaxial receptacle and the marina dock box press the A antenna switch button completely down. At this point the marina TV signal is available to view onboard televisions.

At Sea- Press the B antenna switch button completely down to activate the saucer-shaped television antenna mounted on the hardtop.

To deactivate either antenna switch, push the switch completely in and then release.

When cruising you may encounter a marina without a working shore signal so your backup is to use the ship's antenna. This is more common with older marinas located off the more traveled waterways.

Blu-Ray Player

As standard equipment a Blu-Ray player is connected to select HDTV units. This device produces enhanced TV displays for viewing movies.

The Blu-Ray player is located inside the helm seat locker.

With the player energized and a DVD inserted the player will display its contents on all HDTV sets.

Use Blu-Ray player remote and desired TV remote for playing DVD's.



BLU-RAY PLAYER AT HELM SEAT LOCKER

Television-Typical HDTV Service Locker Components

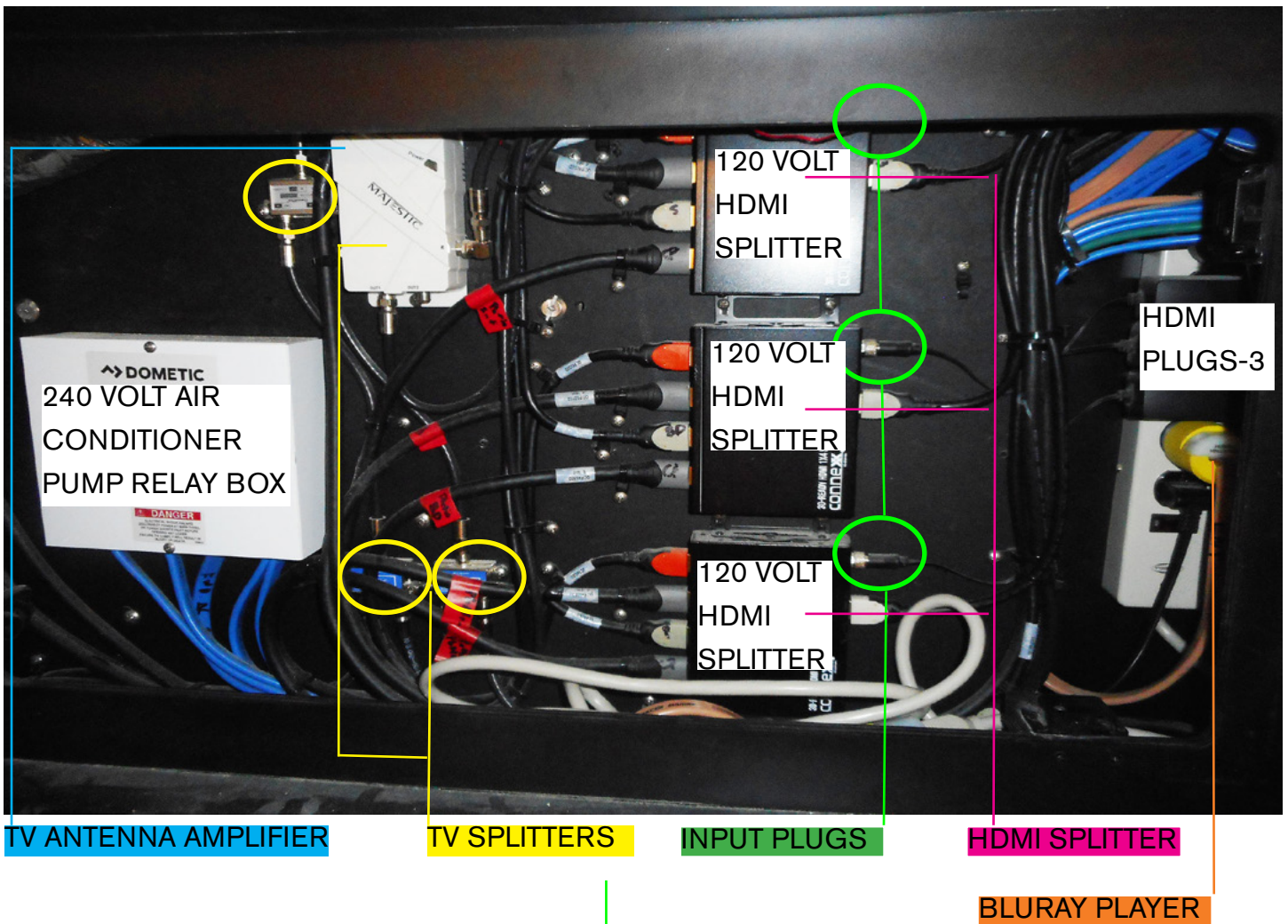

WARNING

AVOID SERIOUS INJURY OR DEATH FROM HIGH VOLTAGE. DISCONNECT SHORE POWER CORD AND TURN OFF ALL ENGINES, GENERATOR & A/C BEFORE SERVICING COMPONENTS IN THE AFT STATEROOM TV LOCKER.

NOTICE

DO NOT STORE ITEMS IN ANY OF THE ONBOARD SERVICE LOCKERS DUE TO POSSIBILITY OF CONTACTING HIGH VOLTAGE AND EXCESSIVE HEAT!

Chapter 5

Engine & Controls

Introduction



Engine four stroke function is based on the following principles; fuel, compression, ignition, and exhaust. All engines offered on the 38 use these principals including gas, diesel, or outboard propulsion.

The proper ratio of fuel and air must be drawn into the engine's cylinders in order to be compressed by the pistons and ignited by spark or compression, the force of which pushes the piston back down providing the energy used to turn your propeller before the engine kicks into the exhaust stage where it expels the by-products.

If any of these four functions fail, so does the engine itself. To learn more about engine functions, systems, and maintenance refer to the engine manufacturer's owner's manual found as part of your owner's information packet.

In addition, be diligent about referring to the information packet as engine and drive propulsion manuals are found there along with most on board component manuals, parts information, and product warranty disclosures. These documents usually include repair station information along with key internet and phone contact options. It is highly recommended that the operator of the craft share the owner's information packet documents with the crew should they be required to access for troubleshooting, etc. should the skipper be unable to assist in these needs.

Bottom line is be prepared!!!

Gas Stern Drive Propulsion & Controls-Part A

Regal Owner's Manual

Your Regal owner's manual covers *basic* operations of the propulsion systems as they relate to the running of the vessel but it should not be thought of as a shop manual. Included is basic maintenance regarding gas and diesel propulsion systems along with troubleshooting guides and technical drawings that cover the basic boat systems.

Following in this section are basic engine checks of the engine and drive lubrication systems, power steering, cooling, and trim system fluids.

Components used on multiple propulsion systems available on this model such as the battery management panel are found in the systems chapter since the information is shared by gas, diesel, and outboard models.

For more specific information refer to your Volvo engine operator's manual.



VOLVO 380 GAS ENGINE SHOWN ABOVE

Volvo Stern Drive Engine Owner's Manual

It is important that you read your stern drive engine manual carefully and become completely familiar with the operation as well as necessary maintenance on the engine and propulsion systems before operating the vessel. Pay careful attention to the sections on winterization if you live in freezing climates. Extensive damage can result if winterization procedures are not followed properly. Contact your closest authorized Regal dealer for information regarding technical issues and parts. Again, much of the information can refer to gas and diesel models. For more specific information refer to your gas or diesel Volvo operator's manual.



WARNING

PREVENT INJURY OR DEATH!
READ ALL MANUFACTURER'S STERN DRIVE
ENGINE AND PROPULSION OWNER'S
MANUALS BEFORE OPERATING
YOUR VESSEL.



WARNING

PREVENT INJURY OR DEATH!
ALWAYS STOP THE ENGINE(S)
BEFORE PERFORMING
ANY ENGINE MAINTENANCE!

Pre-Checklist (Before Starting Engines)

Every engine option may require different checks before each use, but a general engine checklist is included here as a guide.

- Check crankcase engine and out drive oil levels. Use engine manufacturer's specifications and recommendations.
- Check power steering fluid at reservoir.
- Check power trim fluid at trim pump.
- Check power trim for operation.
- Check control lever clip and safety lanyard for functionality (if applicable).
- Check fuel gauge on Garmin screen and ensure the level is sufficient for the trip with a 1/3 reserve.

Starting Engines- Earlier (Volvo System)

Below are basic starting instructions for your vessel using the earlier Volvo system. Refer to the Volvo engine operator's manual for more detailed information on gas and diesel starting procedures.

1. Start all blowers. Run for at least 5 minutes before attempting to start the engines.
2. On earlier systems ensure you press the E-key "on" button to provide power to the batteries and engine ignition panel.
3. On earlier systems make sure the remote control station is activated in the neutral position.
4. On earlier systems depress the "ignition" switch for each engine which will show a green light.
5. On earlier systems depress the port start/stop switch on the Volvo panel until the engine starts. Repeat with the starboard start/stop switch until the engine starts.
6. Allow engines to idle and reach normal operating temperatures. Advance the throttle only button as necessary. Monitor Garmin engine gauge display.

Engine Systems

Engine Cooling System

Your typical engine normally utilizes a raw water system for cooling the engine with intakes on the drive shaft housing. It is important that this system continues to run unobstructed at all times to avoid hazardous situations and to ensure a safe voyage. Raw water is drawn up into the vertical drive shaft housing through pick-up feeds in the housing. Periodically, the coolant system's impeller and water pump should be inspected for debris, damage, or excessive wear due to water chemistry factors such as mineral and/or silt conditions.

If the temperature gauge starts yielding abnormal readings, it may become necessary to look at or replace the engine thermostat after determining whether it is functioning properly.

The thermostat reads the temperature of coolant and determines whether to open or close a valve to allow warm sea water to pass into the exhaust manifolds. The thermostat may recirculate hot coolant for the purposes of reaching standard operating temperatures.

Water passes through an engine mounted thermostat which controls how much water circulates through the cylinder head and engine water passages. The cool water absorbs heat produced by the engine, before being emitted via the coolant exhaust system.

Select engine types use a closed water system featuring a radiator like heat exchanger to keep the engine water at optimum temperature. These systems feature anti-freeze in the closed system side which requires periodic maintenance.

See your engine manual for maintenance schedules.

Freshwater Flushing Attachment

Your engine features a fresh water flushing system. After linking up to a fresh water hose at the flush port, water can be pumped through the engine's raw water cooling system to flush out all salt and debris that may be left behind.

Normally the flush fitting is found on the engine behind the alternator or at the port side of the transom shield. See manufacturers operator's manual for visual and more specific information.

Note to always remove the ignition keys while connecting up the flush device.

After the connection is opened a garden hose is connected to the fitting. Always tighten all connections. Verify that the hose will deliver the correct amount of water pressure (see engine owner's manual for water pressure specification). Turn on the water and check for leaks. The engine can be flushed as it is run at neutral idle speeds. It is best to connect the flushing system up when the engine is warm since the thermostat is open at this time to allow water to circulate through the entire head rather than bypassing the cylinder head areas. Do not run the engine over idle while using the flushing device as engine damage may occur.

Note never to shift into gear while the engine is being flushed.



WARNING

PREVENT INJURY OR DEATH FROM
PROPELLER BLADES!
NEVER SHIFT REMOTE CONTROL INTO
GEAR WHILE FLUSHING THE ENGINE!

Engine Electrical System

Your engine utilizes a great deal of electronic equipment. Some equipment sends signals between the engine and the Garmin, while other systems set off alarms, and still others are used by the engine to generate a spark and ignite the fuel. The helm mounted battery management panel controls DC electrical power distribution to the boat systems through the house and engine cranking battery systems.

To regularly maintain your DC electrical system, inspect the battery charge before each trip. Test all gauges and control equipment prior to departure, and replace as necessary. Spark plugs should be replaced according to your engine owner's manual maintenance schedule.

Gauge Electrical Signals

Your engine transmits signals through electrical harnesses to different components through the use of NMEA 2000 connections and a "backbone system". A standard single Garmin 16" screen plotter or optional dual Garmin 12" screen plotters display the engine functions including fuel and depth readings.

Alarms

When a malfunction with your engine occurs, the Garmin plotter alerts the skipper of a problem. Common engine problems include overheating, low oil pressure, or a miscommunication with equipment. Learn the alarm system faults that apply to your engine by consulting your engine manufacturer's owner's manual at the fault code register page.



CAUTION

AVOID ENGINE DAMAGE OR FAILURE!
DISCONTINUE ENGINE OPERATION
AFTER AN ALARM HAS SOUNDED.
ADDRESS MALFUNCTION BEFORE
RESTARTING ENGINE.

Spark Plugs

The spark plugs are the piece of equipment that generates ignition or spark. As electrical potential builds on one side of the gap based upon the energy distributed by the distributor, the potential eventually grows large enough to cause the electric current to jump the gap on the spark plug. This spark is what ignites the compressed fuel generating a controlled explosion that will power the piston down and deliver power to the drive shaft.

Alternator

Under normal circumstances, the starter battery system would wear down after being used so often to generate a spark for the engines. This isn't an ideal setup because a strong battery is needed for continual operation. A weak battery does no good out on the water. Each engine features a 105 amp hour alternator to recharge the batteries while the engines are running.

However, in an effort to conserve battery life, the battery switch should still be turned off after every trip and turned on at the start of every trip. This limits the drain on the battery while the boat is not in use. As standard equipment a battery charging system (50 amps) charges batteries while the dock side cord is hooked up and engines are off.

Batteries

Never disconnect a battery cable with the engine running as spontaneous charging system damage will occur. On wet cell batteries periodically check for correct electrolyte cell level and fill as needed only with distilled water.

Engine Exhaust System

Your engine expels the by-products of the engine operation through an exhaust system, just like cars do. In boats however, this exhaust system mixes the debris left over after the power stroke of the engine with hot water expelled after cooling the engine.

Basically the exhaust flows through the exhaust manifolds before expelling the exhaust through the vertical drive housing.

Engine Fuel System

Refer to the system chapter of this manual for fuel system specifics. Read & follow warnings below:



WARNING

NEVER USE E-15 OR E-85 ALCOHOL ENHANCED FUEL AS IT CAN LEAD TO DETERIORATION OF THE FUEL SYSTEM COMPONENTS. THIS CAN RESULT IN FIRE AND POSSIBLE EXPLOSION ALONG WITH VOIDING ENGINE WARRANTY.



WARNING

GASOLINE VAPORS CAN EXPLODE! BEFORE STARTING ENGINE. PERFORM SNIFF TEST AND CHECK BILGE FOR GASOLINE LEAKS OR VAPORS.



WARNING

PREVENT INJURY OR DEATH DUE TO FIRE OR EXPLOSION! RUN BLOWER AT LEAST 4 MINUTES BEFORE STARTING ENGINES. RUN BLOWER BELOW CRUISING SPEEDS.

Gasoline Octane Requirements

For stern drive engines use **unleaded** gasoline with the following minimum octane rating:

- In the U.S.A: (R+M)/2 (AKI) - 87
- Outside U.S.A.: (RON) - 90

Note that mid-grade and premium unleaded fuels may provide increased performance and fuel system protection due to the addition of injector cleaners and other additives as used in EFI engines.

Note that engine damage caused by lower octane gasoline than specified above is not covered by the warranty.

Note that leaded gasoline is found in certain markets especially at select gas stations. Leaded gasoline will damage the catalysts and is not to be used in engines with catalytic convertors. Failure of catalysts due to improper fuel is not covered by warranty.

Engine Break-In All Models

All propulsion systems require a pre-determined “break in” period. During this time the engine should not be run at a full load condition for extended periods. Various engine load and speed conditions assist the internal engine parts such as bearings, valves and piston rings to “seat” properly which will help ensure a longer engine life. See operator’s manual for further information.

During the “break in” period it is necessary to check the engine oil more frequently since it is normal that the engine will use more oil. If engine oil is required be sure to check the engine manual for proper grade and viscosity.

Check the maintenance schedule in your engine owner’s manual and contact your Regal yacht dealer to set up the first maintenance inspection. Normally the engine oil, filters, and drive oil inspections and maintenance are performed during this inspection along with other items.

Reference Drawing- Typical Gas Engine Maintenance & Service Component Locations

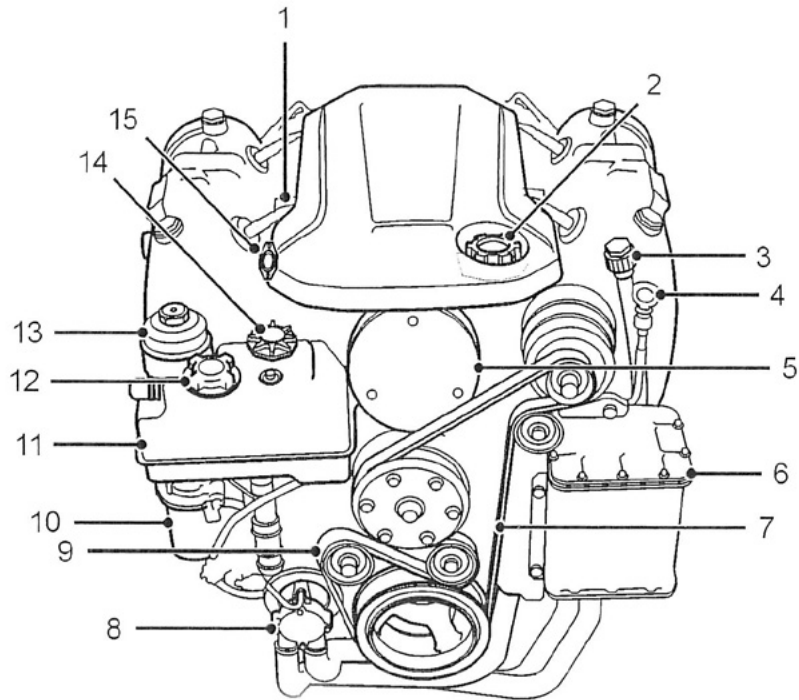

- | | | | |
|---|----------------------|----|--------------------------------------|
| 1 | Fuse and Relay Box | 8 | Seawater Pump |
| 2 | Oil Fill Cap | 9 | Belt Tensioner |
| 3 | Engine Flush Fitting | 10 | Fuel Filter |
| 4 | Engine Oil Dipstick | 11 | Coolant Expansion Tank |
| 5 | Flame Arrestor | 12 | Coolant Fill Cap |
| 6 | Heat Exchanger | 13 | Engine Oil Filter |
| 7 | Serpentine Belt | 14 | Power Steering Dipstick |
| | | 15 | Auxiliary Stop Button ⁽⁴⁾ |

Engine/Drive Lubrication System-Oil Change



CAUTION

AVOID ENGINE DAMAGE OR FAILURE!
CHECK ENGINE/DRIVE OIL LEVELS
BEFORE EACH OUTING. IF LOW ADD
APPROPRIATE OIL TYPE AND QUANTITY.

Engine Lubrication System-Adding Oil/Change

Be sure to read the engine operator's manual regarding engine oil change recommendations. Be sure to follow the Volvo recommended oil type and viscosity. Note that if Volvo oil is not available an alternative oil can be used as specified in the Volvo operator's manual (oil approved for catalyst equipped engines). Be sure to change the oil filter each time the engine oil is changed. The engine oil change is an important factor in obtaining engine longevity since impurities enter the crankcase over time through the combustion process and build up in the engine oil.

Never exceed a 12 month period between oil changes especially with diesel power since sulfur tends to enter the lubrication system through the fuel combustion process over a period of time.

After changing oil always check level with dipstick (see drawing). Add approved oil type and quantity as needed. Wipe the dipstick with a clean cloth. Recheck oil level again. Make sure the oil level is between mark A & B on the dipstick (C). Remember not to overfill the engine crankcase with oil as the engine requires a precise oil level to operate at top efficiency.

Overfilling can result in loss of power, air in the oil, high operating temperatures, and overall reduced engine longevity.

Oil capacity for later V8's is 7.5 U.S. quarts (7.1L) which includes an oil filter change. The oil filter used is a replaceable paper element filter type. Note the O ring as part of the oil filter replacement kit. Coat O ring with fresh engine oil before installing. See the engine reference drawing for oil filter location. Always dispose old filter element in an environmentally friendly way.

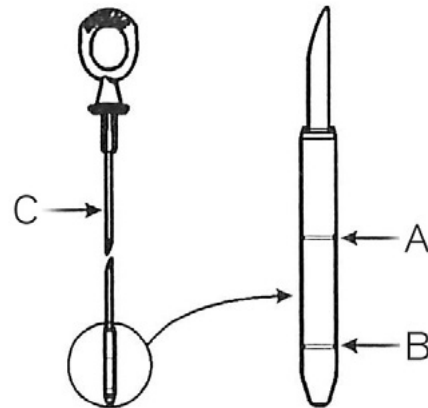

*Courtesy of Volvo Penta

Drive Lubrication System-Adding Oil/Change

The stern drive oil protects the gears and bearings in the vertical drive and gearcase. Like the engine drive oil needs to be checked on a periodic basis preferably before each outing. Do not check if vessel is in the water. Make sure you use the correct type and amount per your engine manual.

Remove the dipstick from the top of the drive unit as shown in the drawing. Note the flat section (A) on the dipstick. This is the top and bottom full range for the drive unit. If it is down from the top of the high mark add oil through the top of the drive unit in small amounts. Wipe dipstick with a clean cloth and reinstall. Recheck for proper level.

If unit is too high, remove oil from the drive until the level is correct. Check dipstick O ring for any gouges or signs of cracking. Re-install dipstick and torque to 48-72 inch pounds. See the service and maintenance manual or contact your closest authorized Regal yacht dealer for further information or authorized Volvo repair facility.

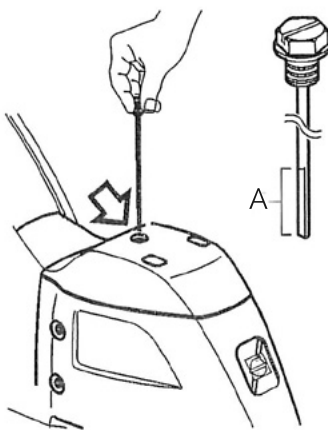

*Courtesy of Volvo Penta

Drive Oil Troubleshooting

When checking for drive oil levels pay close attention to the color of the drive oil on the dipstick. Fresh oil will be amber in color. As drive oil ages it normally darkens in color due to heat and chemical reactions between the internal metal parts such as gears and bearings. Normally a darker color should alert the operator to the need for changing the drive oil.

Note that on Ocean drives only after changing the drive oil there is a drive sensor that needs to be reset or an alarm will sound. Refer to the manufacturer's operating manual for more information.

Another item to monitor with the drive oil dipstick is to look for a milky drive oil color. A milky consistency indicates there is water mixed in with the oil. Normally this is caused by a seal failure at the prop shaft or more unlikely the intermediate housing. Fish line is one item that gets wrapped around the prop shaft in front of the propellers and can eventually cut the seals due to the prop shaft turning around the line. Removing the propellers and a visual inspection may show the fish line around the prop shaft. In any case do not continue to run the propulsion unit with water in the oil as it could cause internal bearing failure due to overheating. Call your closest authorized Regal yacht dealer for assistance.

Lastly, monitor the drive oil dipstick for drive oil that appears to contain metal flakes or small metal particles. They appear shiny in the oil with day light. Causes of excessive metal particles are premature gear or bearing wear due to overheating. Discontinue use and contact your Regal dealer.

Power Steering-Checking/Adding Fluid

The power steering system utilizes a fluid used in the internal hoses and cylinder to assist in turning the stern drive as the steering wheel is rotated. This is another one of those checks which is best to be preformed before each outing.

Find the power steering reservoir on the engine. See drawing here as it displays the major parts including the power steering dipstick. Unscrew the power steering dipstick by turning it counterclockwise. Fluid level on dipstick (B) should be in the (A) range as shown in the drawing. Add Volvo Trim/Tilt and Power Steering Fluid to the reservoir. Wipe the dipstick with a clean towel, reinstall, and check fluid level to the (A) requirement. Do not overfill the reservoir. Ensure that foreign particles do not enter the reservoir when checking or filling it.

Note that in lieu of Volvo Penta fluid use Dextron 2 or higher such as Dextron 3. Never use other brands, types, or viscosities of fluids not approved since they may cause steering problems and/or component damage.

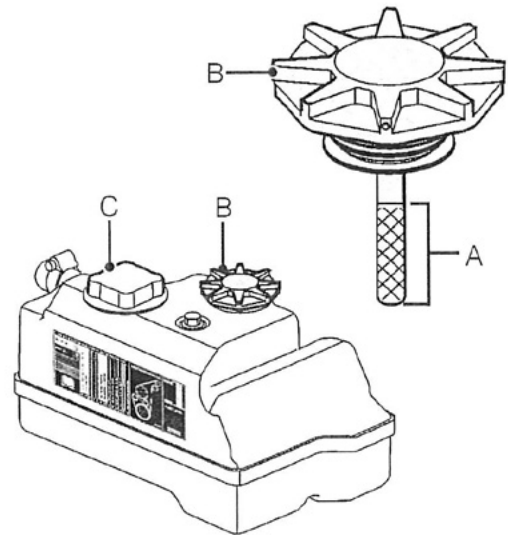

*Courtesy of Volvo Penta

Fresh Water System-Checking/Adding Coolant

The fresh water coolant needs to be checked before each outing. Read and understand the following fresh water coolant system warnings:



WARNING

PREVENT INJURY DUE TO HOT LIQUIDS!
DO NOT OPEN THE COOLANT CAP
WHEN THE ENGINE IS HOT AS STEAM OR
HOT ANTI-FREEZE COULD CAUSE BURNS!



WARNING

PREVENT INJURY OR DEATH!
ETHYLENE GLYCOL COOLANT IS
POISONOUS TO HUMANS AND ANIMALS
IF INGESTED. DISPOSE OF ALL COOLANT
IN A ENVIRONMENTALLY FRIENDLY WAY!



CAUTION

AVOID EYE IRRITANT POTENTIAL!
WEAR EYE PROTECTION
WHEN WORKING WITH COOLANT.
WEAR GLOVES & WASH HANDS OFTEN!

Note that the engine coolant reservoir uses a special yellow VCS Volvo coolant. Never mix coolant types such as green or pink anti-freeze with the more advanced type yellow VCS. This yellow VCS coolant adds more corrosion protection and prevents clogging for newer engines using a variety of metal alloys. VCS is a silicate-free coolant based on OAT (organic acid technology).

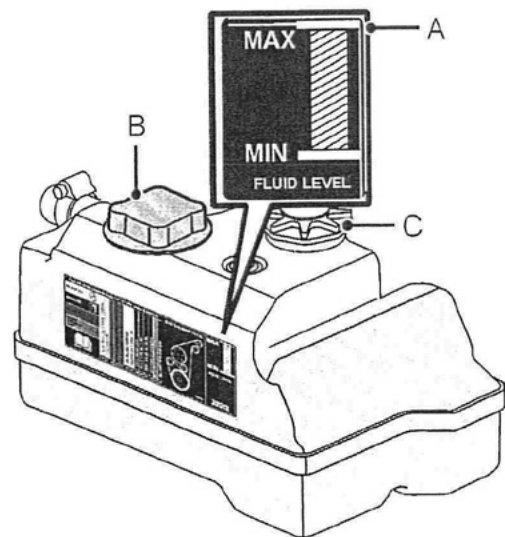

*Courtesy of Volvo Penta

Overall, the inhibitors provide additional protection against corrosion, cavitation, and deposits.

Note that that VCS still contains glycol to prevent freezing in cold climates.

Monitor the visual minimum and maximum levels on the side of the reservoir. Add VCS coolant to the reservoir by removing cap B (do not remove cap C as it is for power steering fluid). Fill the reservoir using a funnel. Make sure you do not overfill the reservoir beyond the MAX. level A.

Obtain VCS coolant from an authorized Regal or Volvo dealer. It is available in a pre-mixed container or if using full strength anti-freeze be sure to dilute to 50/50 mix of anti-freeze and distilled water. If refilling entire cooling system refer to coolant capacity guidelines in the Volvo operator's manual.

Fuel System-Replacing Water Separator Filter

Open the engine hatch completely to provide accessibility and to ventilate the engine compartment. Remove keys from ignition and follow label below.

To change the engine mounted water separator filter the following items are needed; new fuel filter, wrench to remove and install filter, clean engine oil, along with container/clean rags.

Install a container under the fuel filter and position in place using clean rags. Wrap the filter wrench around the fuel filter and turn counterclockwise to break the filter loose. Turn until filter is free and carefully dump the filter contents into the container outside of the engine compartment.

Examine fuel for small droplets in the bottom of the container which normally end up to be water.

Also, check for dark foreign particles in the fuel which could originate from where the fuel was purchased. Always obtain your fuel from a facility that sells large amounts of fuel as chances of problems existing from older fuel batches is lowered.

Lubricate the gasket or O ring on the new fuel filter. Screw the new filter on to the pump assembly. Hand tighten. Do not overtighten with a wrench. Clean up any spilled fuel. Discard container and rags in an environmentally friendly fashion.

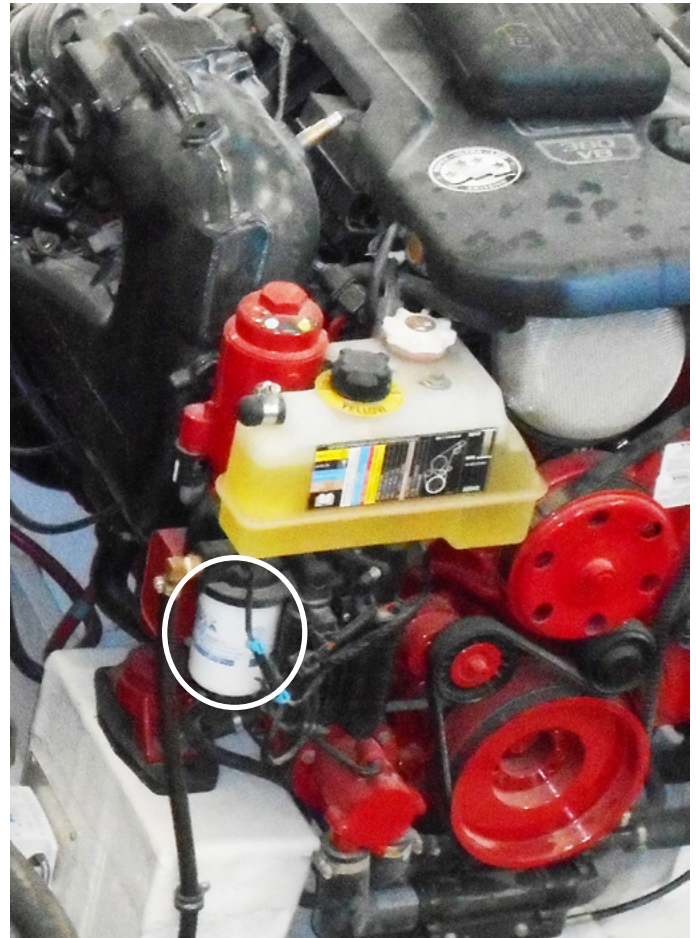

It is recommended to run the blower for at least 4 minutes to vent engine space and below cruising speeds. Start the engine and check for leaks especially around the filter area. Read and understand the label below.



DANGER

AVOID BODILY INJURY OR DEATH DUE TO
EXPLOSION OR FIRE!
IF YOU DETECT ANY FUEL LEAKAGE TURN
OFF THE ENGINE IMMEDIATELY.
CORRECT ANY LEAKAGE!

Helm Controls

Digital Instrumentation

The Regal yacht helm station (dash) is equipped with a chart plotter system referred to as the Volvo “Glass Cockpit” which monitors the condition of the gas or diesel stern drive propulsion components. This digital system replaces individual analog propulsion gauges. Propulsion signals are read digitally and sent to the plotter for display and monitoring through a system called NMEA 2000. Close observation of the plotter system is the responsibility of the captain while cruising. Periodically scan the screen for all the key propulsion readings. The plotter system also provides GPS and navigational information for components such as radar (if installed) and monitors the Fusion® entertainment system.

Note that on Yamaha outboards a Garmin plotter display is used to monitor the condition of the engine components. The NMEA 2000 is the system used to communicate and display the signals on the Garmin plotter system.

Other standard and optional dash instruments called displays present digital information on various systems. Become familiar with all the displays and their functions through their normal operating specifications as outlined in this manual and the Volvo engine operation manual. Display options may include a Garmin GRID module, E-key remote for battery management panel, windlass remote, Seakeeper panel, Fusion Apollo™ entertainment, VHF marine radio panel, battery management display, gas vapor detector, trim tab control and various others. We will touch on select displays in this manual. Refer to the manufacturer’s manual for more specific information.

After educating yourself in the functionality of the “glass cockpit” if installed be sure to train another person as the skipper’s backup. This person should know how to read the screen and how to recognize and respond to system “fault” codes should they occur.

Helm Systems/Gas Stern Drive

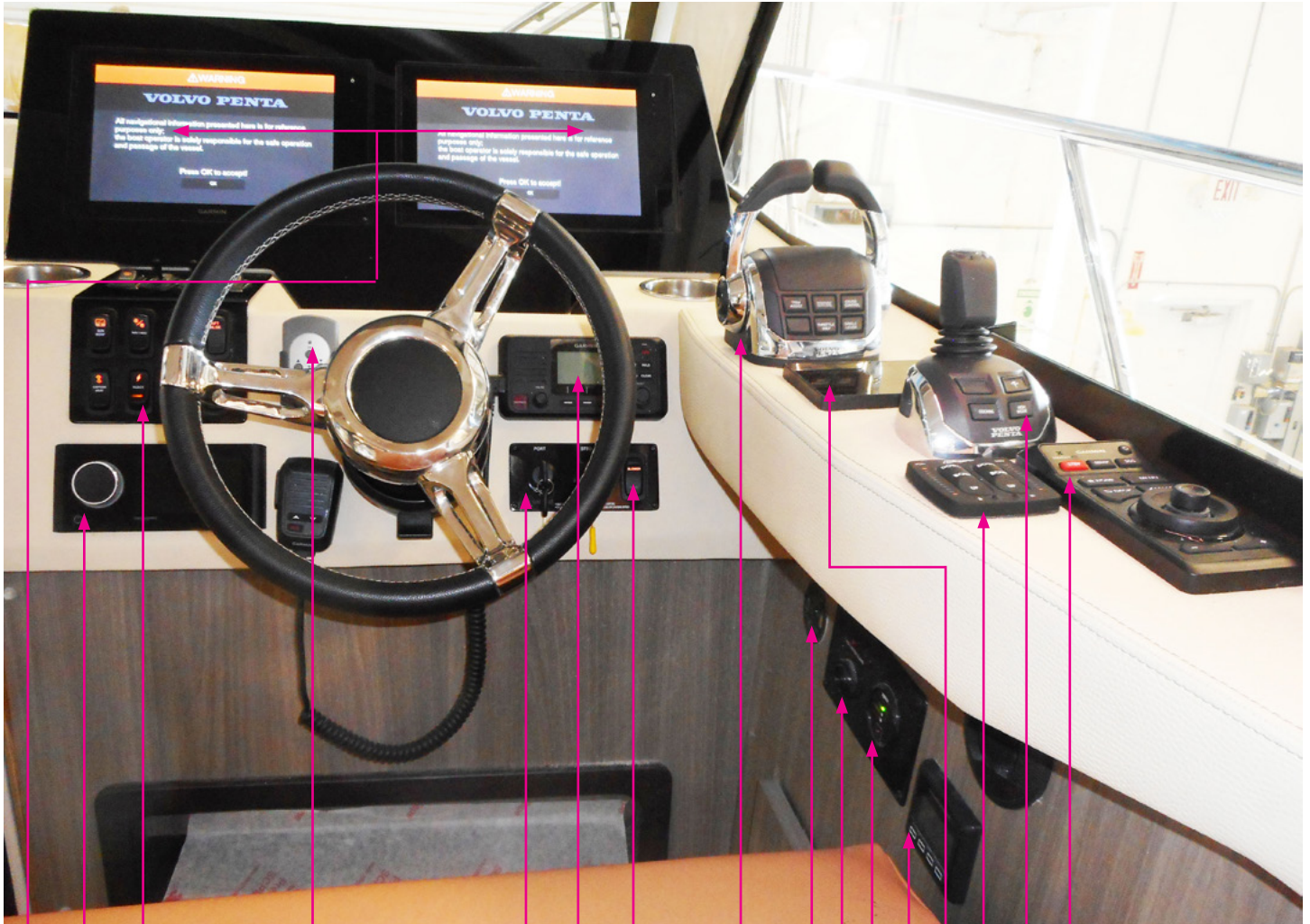

WINDLASS REMOTE

IGNITION PANEL

VHF MARINE RADIO

SWITCH PANEL

BLOWER SWITCH

REMOTE CONTROL

AUTOMATIC FIRE EXTINGUISHER
SYSTEM ALARM/GAUGE

GARMIN GRID

HIGH WATER ALARM

JOYSTICK

FUSION APOLLO

GAS VAPOR DETECTOR

TRIM TAB PANEL

CHART PLOTTERS

START-STOP & BATTERY MANAGEMENT DISPLAY

SEAKEEPER CONTROL

Note that select items above may be optional and may not be installed on your vessel.

Volvo EVC Remote Control

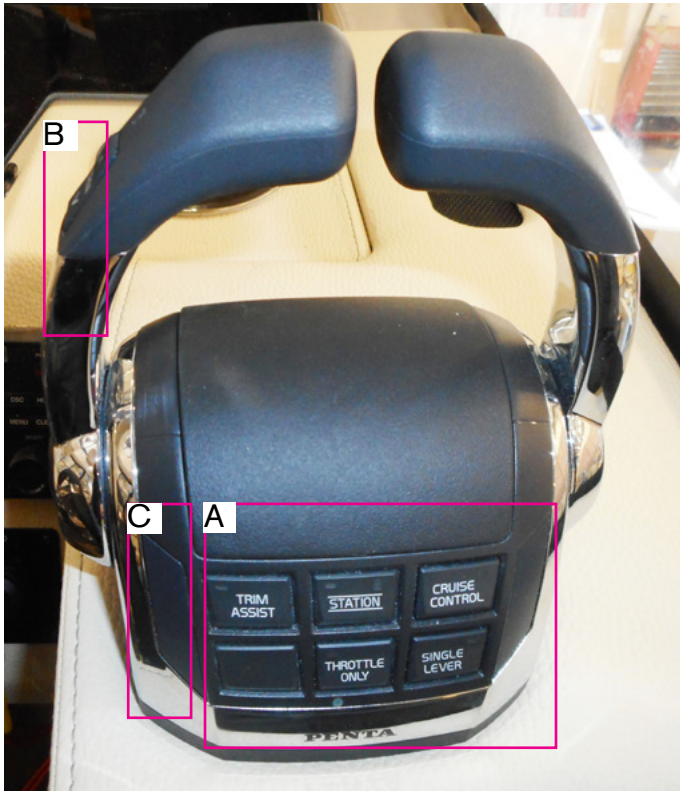

TYPICAL STERN DRIVE REMOTE CONTROL

The following is a description of functions as seen in zone **A** shown above. Refer to the engine manual for more specific operational information or contact an authorized Regal yacht dealer.

Trim Assist- The Power Trim Assistant button adjusts the trim angle automatically according to engine speed (rpm).

Station- This button is lighted when the helm station is activated.

Cruise Control- when this button is pressed it permits the operator to fine tune engine speed by increasing or decreasing engine rpm with the button on the forward side of the control. Use the + or - on the button to increase or decrease engine rpm.

Throttle Only button- when pressed it disconnects the shift function. At this point the control lever only effects the engine speed.

Single Engine- Pressing this button permits the operator to control both engines with one lever.

At Zone **B** the following function is indicated:

Trim- Pressing this button with twin engines permits the drives to be trimmed in or out as a synchronized unit.

Neutral position- This symbol shows that the engine and drive are not in gear. Note that a safety device keeps the control from starting in gear.

At Zone **C** the following functions are indicated:

Warning triangle- This triangle lights up when a system fault is recognized. It will project on the side where the driveline with the problem exists. If an emissions (MIL) light fault appears contact an authorized dealer.



CAUTION

PRACTICE YOUR REMOTE CONTROL
SHIFTING IN A WATER
ENVIRONMENT WITHOUT HEAVY
BOAT TRAFFIC.



CAUTION

TO PREVENT POSSIBLE BODILY INJURY
AND/OR PROPERTY DAMAGE
DO NOT ATTEMPT TO ADJUST SHIFT
OR THROTTLE CONTROLS!
CONSULT A MARINE PROFESSIONAL.

Volvo Joystick (Maneuvering Component)



TYPICAL STERN DRIVE STEERING JOYSTICK

The joystick is a component used to maneuver and dock the vessel at low speed. Note that only the docking and high mode functions are used with twin stern drive propulsion. See your manufacturer's engine manual for specific information.

**CAUTION**

PRACTICE YOUR JOYSTICK DOCKING AND MANEUVERING IN A WATER ENVIRONMENT WITHOUT HEAVY BOAT TRAFFIC.

High Mode- This mode may be used to offset sea conditions such as a strong current or high wind. To use make sure the docking button is lighted. Activate high mode by pressing the high mode button on the lower right side of joystick. An audible signal indicates that high mode is activated and the button perimeter lights up.

The high mode function can be deactivated by pressing the button again. An audible signal will sound twice to indicate the high mode is deactivated and the light will go out.

At this point the joystick is in the docking mode.

Docking Mode- *Note that when the docking mode is activated, engine speed (rpm) is limited and the vessel steering can only be accomplished through the joystick.*

To activate the docking mode the following pre-conditions must be met:

1. Both engines must be running.
2. Both remote control levers in neutral.
3. Helm station must be activated.
4. Joystick must be in center position.

Press the docking button to activate the docking mode. An audible signal will emit and indicate the docking mode is activated. The docking button light will be visible.

To deactivate the docking mode press the docking mode button. An audible signal will be emitted twice to indicate the docking mode is deactivated. The docking light will go out.

Note the docking mode will be activated if the remote controls are moved from the neutral position.

JOYSTICK FUNCTIONS

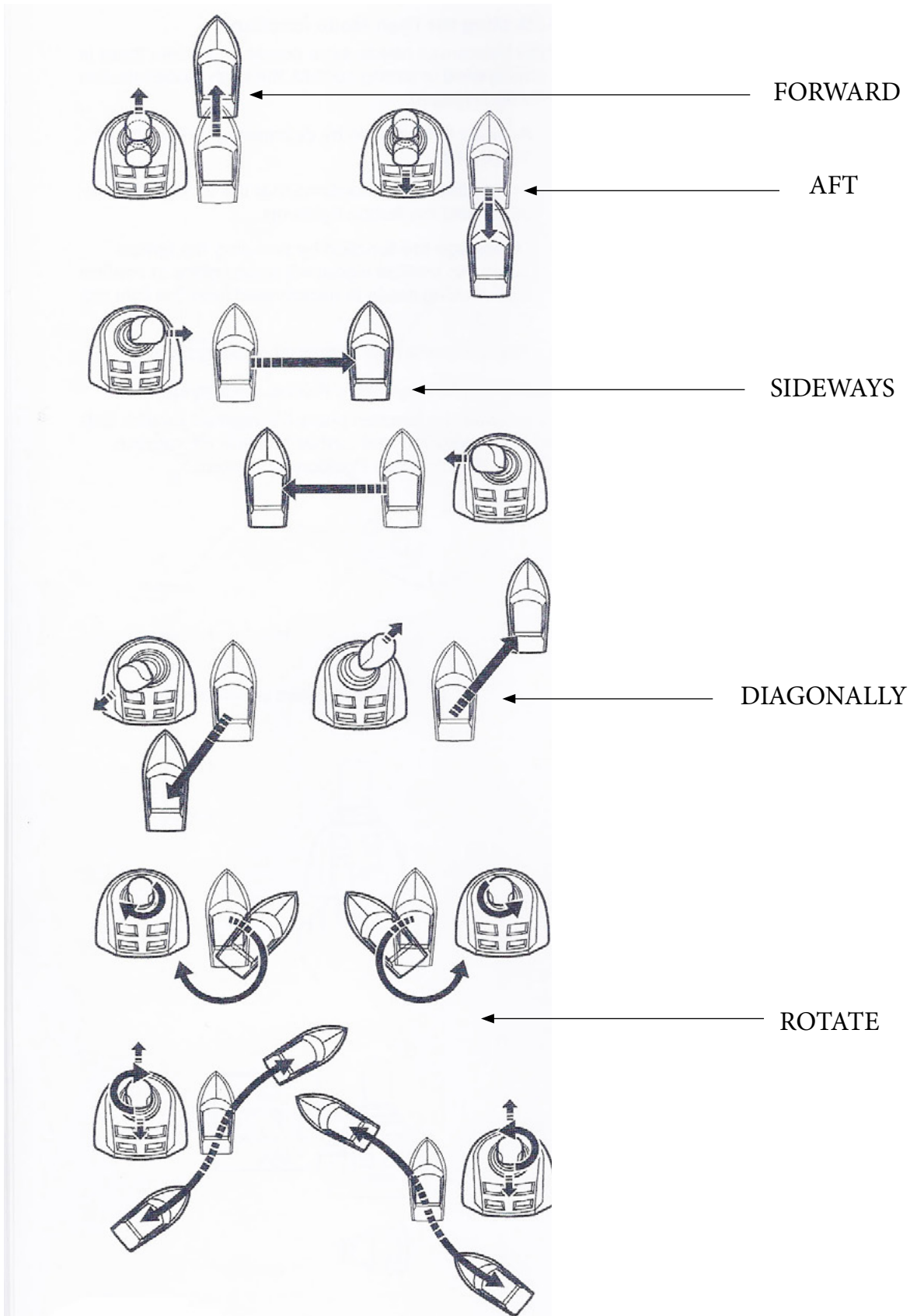

Outboard Propulsion/Controls-Part B

Regal Owner's Manual



It is important that you read your outboard engine manual carefully and become completely familiar with the operation as well as necessary maintenance on the engine and propulsion systems. Pay careful attention to the sections on winterization if you live in freezing climates. Extensive damage can result if proper winter storage is not followed in freezing climates. Contact your Regal dealer for information regarding technical issues and parts. Also, refer to the maintenance section of this manual.

This section is intended to give general information about the function of typical outboard engine and controls. Control systems and engines may vary from boat model to model.

Refer to the specific engine operator's manual for your equipment that would include the following information in greater detail. Beyond these basic concepts of engine functionality is the engine cooling, lubrication, and electrical systems. The specific details of these systems can be found in the engine manufacturer's owner's manual for the specific engine option installed on your Regal boat. Components used on multiple propulsion systems available on this model such as the battery management panel are found in the systems chapter since the information is shared by gas, diesel, and outboard models.

Engine Removal

If the outboard engine needs to be removed from the transom consult your closest authorized Regal dealer. He has the factory trained knowledge and equipment to remove the engine safely and efficiently.



WARNING

PREVENT INJURY OR DEATH!
READ ALL MANUFACTURER'S OUTBOARD
ENGINE AND PROPULSION OWNER'S
MANUALS BEFORE OPERATING
YOUR VESSEL.

Engine Checklist Before Each Outing

Every engine option may require different checks before each use, but a general engine checklist is included here as a guide.

- Check crankcase engine and gear case oil levels.
- Check steering fluid.
- Check power trim fluid.

At Helm/ Deck

- Check power trim for operation.
- Check control lever clip and safety lanyard for functionality (if applicable).
- Check fuel gauge and ensure the level is sufficient for the trip with a 1/3 reserve.
- Check other gauges on the plotter display for proper levels.

Engine Cooling System

Your typical engine normally utilizes a raw water system for cooling the engine with intakes at the gear case. It is important that this system continues to run unobstructed at all times to avoid hazardous situations and to ensure a safe voyage.

Raw water is drawn up into the outboard vertical drive shaft housing through pick-up feeds in the gear case vicinity.

Water passes through a power head thermostat which controls how much water circulates through the power head. The cool water absorbs heat produced by the engine, before being emitted via the coolant exhaust system.

There is a pilot hole on the port side of the power head which shows a visual stream of water at all times. If no water is visible with the engine running shut down the engine and investigate the problem. At times this pilot hole can be plugged by debris. Use a thin round cable to run through the pilot hole and recheck for a visible stream of water.

Impeller/ Water Pump

Periodically, the coolant system's impeller and water pump should be inspected for debris, damage or excessive wear due to water chemistry factors such as mineral and/or silt conditions. Worn parts will affect the system's ability to function, and may cause engine damage due to overheating. Contact your closest Regal dealer for more information and maintenance schedules of key outboard engine systems.

Thermostat

If the temperature gauge starts yielding abnormal readings, it may become necessary to look at or replace the power head thermostat after determining whether it is functioning properly. The thermostat through a sensor reads the temperature of coolant and determines whether to open or close a valve to allow warm sea water to pass into the exhaust manifold. The thermostat may recirculate hot coolant for the purposes of reaching standard operating temperatures.

If standard operating temperatures have been reached, the spring loaded thermostat will open and allow hot raw water to exit through the exhaust manifold.

For more information read your outboard engine manual or contact the closest Regal dealer. Dealers have the necessary knowledge and tools to troubleshoot any engine related problems.

 WARNING
PREVENT INJURY DUE TO HOT SURFACE! AVOID TOUCHING THE THERMOSTAT OR ITS COMPONENTS WHILE THE ENGINE IS HOT.

 CAUTION
TO PREVENT ENGINE DAMAGE AVOID RUNNING THE ENGINE WITHOUT A FUNCTIONING THERMOSTAT.

Freshwater Flushing Attachment

Your outboard features a fresh water flushing system. After linking up to a fresh water hose at the flush port, water can be pumped through the engine's raw water cooling system to flush out all salt and debris that may be left behind. Normally there is a hose thread fitting on the side of the engine. After the connection is opened a garden hose is connected to the fitting and the engine can be flushed. It is best to connect the flushing system up when the engine is warm since the thermostat is open at this time to allow water to circulate through the entire head rather than bypassing the cylinder head areas. Do not run the engine with flushing device as engine damage may occur.

Engine Electrical System

Your engine utilizes a great deal of electronic equipment. Select equipment sends signals between the engine and the "Glass Cockpit" or Garmin, while other systems set off alarms, and still others are used by the engine to generate a spark and ignite the fuel. The battery switch controls electrical power distribution to the boat systems.

To regularly maintain your DC electrical system, inspect the battery charge before each trip. Test all gauges and control equipment prior to departure, and replace as necessary. Spark plugs should be replaced according to your engine operator's manual maintenance schedule.

Gauge Electrical Signals

Your outboard transmits signals through electrical harnesses to different components through the use of NMEA 2000 connections and a "backbone system" located behind the helm. A standard "Glass Cockpit" or twin Garmin plotters display the engine functions. Idiot lights are display tolerances that are classified as being abnormal.

Alarms

When a malfunction with your outboard engine occurs, the "Glass Cockpit" or Garmin plotter alerts the skipper to a problem. Common engine problems include overheating, low oil pressure, or a miscommunication with equipment. Learn the alarm systems that apply to your engine by consulting your engine operator's manual.



CAUTION

AVOID ENGINE DAMAGE OR FAILURE!
DISCONTINUE ENGINE OPERATION
AFTER AN ALARM HAS SOUNDED.
ADDRESS MALFUNCTION BEFORE
RESTARTING ENGINE.

Spark Plugs

The spark plugs are the piece of equipment that help make ignition occur. As electrical potential builds on one side of the gap based upon the energy distributed by the distributor, the potential eventually grows large enough to cause the electric current to jump the gap on the spark plug. This spark is what ignites the compressed fuel generating a controlled explosion that will power the piston down and deliver power to the drive shaft.

Stator

Under normal circumstances, the starter battery would wear down after being used so often to generate a spark for the engine. This isn't an ideal setup because a strong battery is needed for continual operation. A weak battery does no good out on the water. A magnetic stator recharges the batteries while the engines are running.

However, in an effort to conserve battery life, most breakers should be turned off after every trip and turned on at the start of every trip. As standard equipment a battery charging system charges batteries while the dock side cord is activated. It is a 50 amp charger.

NOTICE

NOTE THAT THE VESSEL USES A SEPARATE WIRE FROM ONE OUTBOARD STATOR TO CHARGE THE HOUSE BATTERIES AND ANOTHER DESIGNATED WIRE FROM THE OTHER OUTBOARD STATOR TO CHARGE THE ENGINE CRANKING BATTERIES.

Fuses

Your engine also comes equipped with fuses that will burn out or "blow" when engine components attempt to draw more power than the piece of equipment or wiring can handle. When the fuse blows, it breaks the circuit, and electricity stops flowing. Before replacing the fuse, investigate the cause of the problem, and why the equipment was overworked. Your outboard engine uses a helm mounted fuse box which is accessible by lifting the starboard bow backrest while others feature in-line fuses, while still others feature a mixture of both. Refer to your outboard engine owner's manual for complete details on your electrical system and the location of any engine mounted over current protection.

Batteries-Outboard System/Earlier

The outboard features select differences in the battery circuitry, components and their location. The center outboard engine utilizes an electric automatic remote battery switch located on the port bilge hull side. This switch is used to break up the battery circuitry long runs and replaces one of the BCM units used on the stern drive units. A feature of this remote battery switch is that it can be deactivated (locked off position) This shuts off power to the center outboard for any maintenance required. See the illustrations and read the notice.



REMOTE BATTERY SWITCH- OFF POSITION



REMOTE BATTERY SWITCH- ON OR REMOTE- POSITION-(NOTE ALIGNMENT MARKS)

NOTICE

THIS VESSEL IS EQUIPPED WITH ELECTRIC AUTOMATIC BATTERY SWITCH(ES). THE CONTROL KNOB ON THESE BATTERY SWITCHES MUST BE IN THE REMOTE POSITION TO FUNCTION CORRECTLY.

Engine Exhaust System

Your engine expels the by-products of the engine operation through an exhaust system, just like cars do. In boats however, this exhaust system mixes the debris left over after the power stroke of the engine with the hot water that is expelled after cooling the engine.

Basically the exhaust flows through the power head before expelling the exhaust through the vertical drive housing either just above the propeller, or through the prop shaft.

Engine Fuel System

Refer to the system chapter of this manual for fuel system specifics. Be sure to read and understand the following warnings.



WARNING

USE OF ALCOHOL ENHANCED FUEL, OR ANY FUEL OTHER THAN GASOLINE CAN LEAD TO DETERIORATION OF THE FUEL SYSTEM COMPONENTS. THIS CAN RESULT IN FIRE AND POSSIBLE EXPLOSION.



WARNING

GASOLINE VAPORS CAN EXPLODE! BEFORE STARTING ENGINE CHECK COMPARTMENTS AND MOTOR WELL FOR GASOLINE LEAKS OR VAPORS.



WARNING

PREVENT INJURY OR DEATH DUE TO FIRE OR EXPLOSION! RUN GENERATOR BLOWER AT LEAST 4 MINUTES BEFORE STARTING GENERATOR.

The fuel system includes the fuel tank, fuel feed lines, fill and vent fittings along with fuel filters, emission devices, natural and powered ventilation systems.

Gasoline today is processed in a different manner than it was a few years ago. As a result it has become more unstable and the product shelf life has been shortened.



Outboards in this size range normally utilize a metal fuel tank. A special low permeability bulb and hose is supplied by the engine manufacturer to feed the fuel from the tank

to the outboard engine. Sometimes it is necessary to pump the gas line hose bulb before starting the engine. *Note that the fuel line bulb and hose for each engine is in the lazarette storage area connected to the outlet side of the fuel filter.* If the need arises to replace the fuel bulb be sure to turn the arrow imprinted on the bulb toward the engine side for correct fuel flow.

Read and understand the outboard owner's manual fuel section and safety information before attempting to use the vessel.

Note that due to a possible fire or explosion danger never store flammable liquids and/or portable outboard fuel tanks in any onboard storage compartment such as the cockpit Lazarette locker.

Outboard Fuel Tank Description

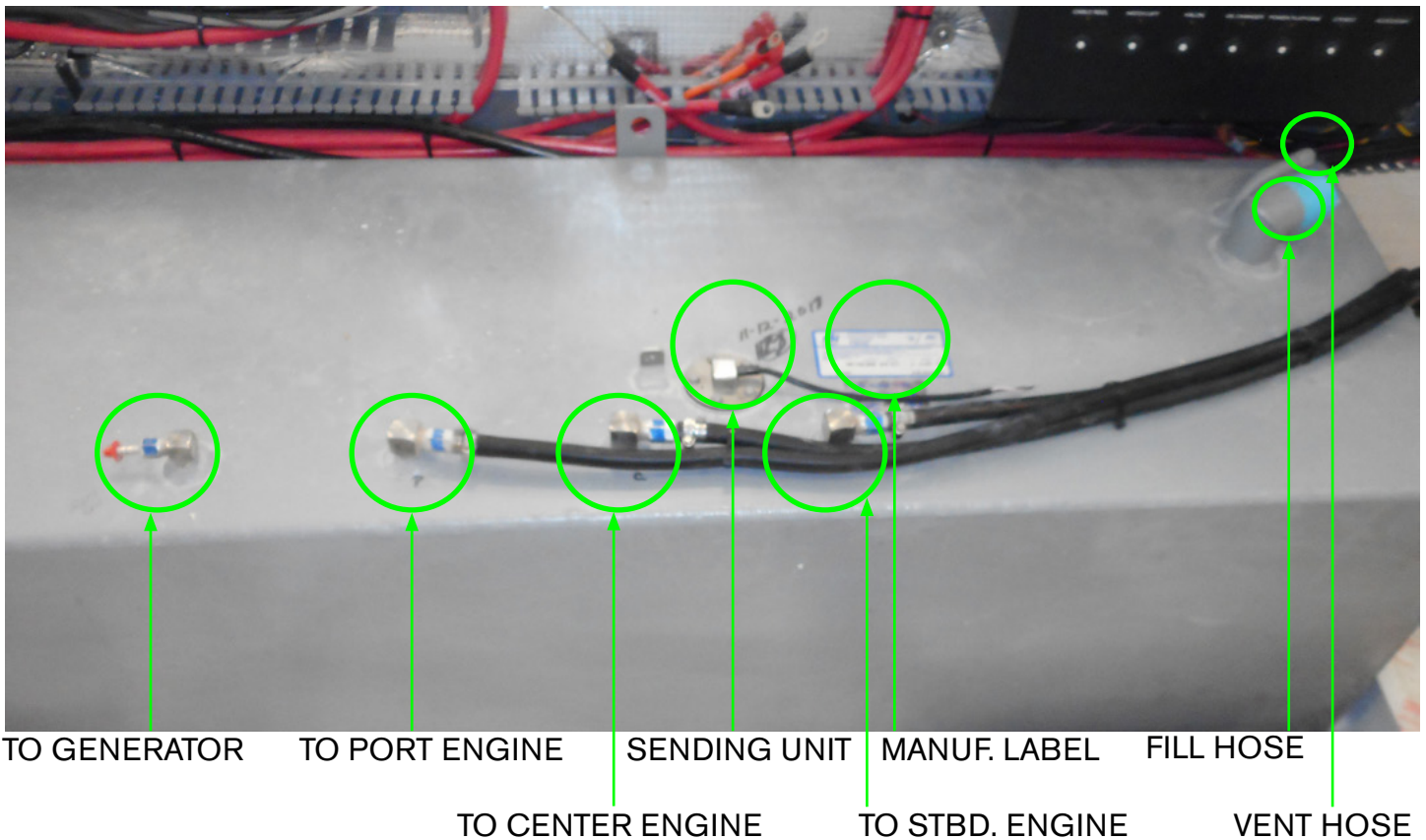

Fuel Tank Overview

The outboard fuel tank is set up uniquely to serve three engines and a generator. *Note the hoses shown above and their destination. This information may be helpful in troubleshooting situations.*

Each engine and generator at the tank "out" fitting provide anti-siphon protection in the unlikelyhood the hose between the tank and the engine would develop a leak. This valve will stop the flow of fuel. Never remove the anti-siphon ball and spring located inside the valve. If valve is inoperative replace the valve which is available at marine outlets or can be ordered from your Regal yacht dealer.

A symptom of an anti-siphon valve problem would be fuel starvation normally at mid or high speeds.

Of course if the fuel source was completely in a starvation mode the engine may not even start.

At least once per year check entire fuel system for leaking fuel. Tighten all fuel hose clamp connections, and inspect all fuel hoses for leaks and abrasion.

Gasoline Specifications/Octane Ratings:

Gasoline Requirements- Use premium non-leaded gasoline with the following minimum octane rating for Yamaha outboard engines:

▪ **Minimum pump octane number (PON) is 89.**

Gasoline in the United States and other areas is blended with 10% ethanol and is known as E-10 at the pumps. Marine engines used in your Regal boat may be operated with premium unleaded gasoline blended with no more than 10% ethanol and that meets the minimum octane specification.

Do not use ethanol blends greater than 10% such as a newer blend for select motor vehicles called E-15 or E-85. Your marine engine may be damaged by more than 10% ethanol. A loss of performance may occur and the engine will not be covered by the engine manufacturer's warranty.

Refer to your outboard manufacturer's operation manual for additional information regarding the proper octane level for your outboard model. Using the wrong octane level may cause permanent engine damage such as piston detonation.

As an option contact your outboard manufacturer's hot line or text on web with fuel related questions. Also, additional fuel system information may be as close as your Regal dealer. He has acquired special training on propulsion and vessel systems.

Fuel Filters

Fuel filters are found on outboards under the motor shroud (cover) which should be serviced periodically per the outboard motor manufacturer's instructions.



In addition, Regal installs an in-line 10 micron water separator filter for each outboard which is a spin on and off type similar to an automobile oil filter.

Its main purpose is to trap small dirt particles and condensation (water) in fuel. It is a good idea to keep extra fuel filters on board along with a strap style filter wrench, catch container and clean rags for emergencies. Never use automotive style fuel filters on your vessel. Dispose of all fuel residue materials in an environmentally safe fashion.

These filters are available on-line, through marinas, retail marine outlets, or can be ordered via your closest Regal outboard dealer.

Read and understand the label below regarding the storage of flammables on board the vessel.

WARNING

PREVENT INJURY OR DEATH!
FUEL VAPORS
ARE A FIRE AND EXPLOSION HAZARD.
DO NOT STORE FUELS,
FLAMMABLE LIQUIDS
OR PORTABLE FUEL TANKS ON BOARD!

Engine Lubrication System

Whenever two components rub together, friction causes wear on both components. To minimize the wear on your engine, a lubrication system has been put in place to help components slide next to each other easier. This is particularly important within the inner workings of an engine. It is important to ensure your lubrication system is working properly at all times.

Your Regal utilizes lubrication and fluids that need regular check ups. Refer to your outboard engine owner's manual for specific details regarding the proper maintenance of the lubrication system.

Note that your outboard uses other lubricants in addition to engine oil such as power trim fluid and prop shaft gear case lubricants to reduce wear on moving components. All these fluids should be checked according to the recommended maintenance procedures determined by the outboard manufacturer.



CAUTION

AVOID ENGINE DAMAGE OR FAILURE!
CHECK THE ENGINE OIL LEVEL
BEFORE STARTING. IF LOW ADD
APPROPRIATE OIL TYPE AND QUANTITY.

Engine Oil

The purpose of engine oil is to lubricate the internal components of the engine and ensure that parts that regularly move against each other have reduced friction to lessen wear and noise between components. An oil filter keeps metal particles and water out of the engine's interior.

Yamaha engines performing on regular oil should have the oil drained and replaced after the first 20 hours of operation or 3 months, and every 100 hours or at 1 year intervals thereafter.

Gearcase Oil

Gearcase oil keeps all the mechanical components of the prop shaft gear assembly functioning optimally. It reduces friction in the gear case as the gears revolve. Sometimes gear case oil is called gear lubricant. Gearcase oil should be inspected periodically according to factory maintenance schedules. Use the outboard manufacturer's recommended oil.

Power Trim Fluid

Power trim fluid allows your outboard to trim up or down. This is particularly useful when trying to get your boat to plane. Power trim fluid is used in hydraulic rams that maneuver the outboard unit. Power trim fluid should be checked regularly in the reservoir which is located in the bilge.

Propeller System

Refer to the outboard manual for procedures, as the application is unique to the manufacturer. Call a marine professional or your Regal dealer for to order a spare propeller set and hardware.

Propeller Checklist

At least twice a year, check the propeller for:

- Loose, missing, or corroded hardware.
- Nicks, dings, or missing propeller material
- Bent propeller blades.
- Objects wrapped around the prop (fish line)
- Decomposing propeller blades (electrolysis symptom).
- If equipped, check the propeller rubber hub for slippage
- Carry an extra set of propellers and hardware.

Contact a propeller shop or your closest Regal dealer if any of the above symptoms exist. They have purchased special equipment to refurbish both stainless steel and aluminum propellers.



LEFT HAND PROPELLER RIGHT HAND PROPELLER RIGHT HAND PROPELLER

Regal has carefully tested and chosen the propellers to give your outboard boat the best possible performance based on the engines and propulsion packages offered. We have allowed for the additional weight in equipment that might be added to the boat. It is a good idea to carry a spare set of propellers and hand tools onboard in order to expedite emergency propeller changes.

Each Yamaha propeller displays the following information:

1. Propeller pitch shown by inches.
2. Propeller type (L for left or R for right).
3. Propeller diameter in inches.

Your Regal features triple outboards. The port engine rotates counterclockwise and uses a left hand propeller. The center and starboard engine rotate clockwise (standard) and use a right hand propeller.

 **WARNING**

AVOID A POSSIBLE ACCIDENT CAUSING INJURY, DEATH OR PROPERTY DAMAGE!
NEVER USE A STANDARD PROPELLER ON A COUNTER ROTATION ENGINE, OR A COUNTER ROTATION PROPELLER ON A STANDARD ROTATION ENGINE. THE VESSEL COULD TRAVEL IN AN UNEXPECTED DIRECTION.

Helm Systems-Outboard

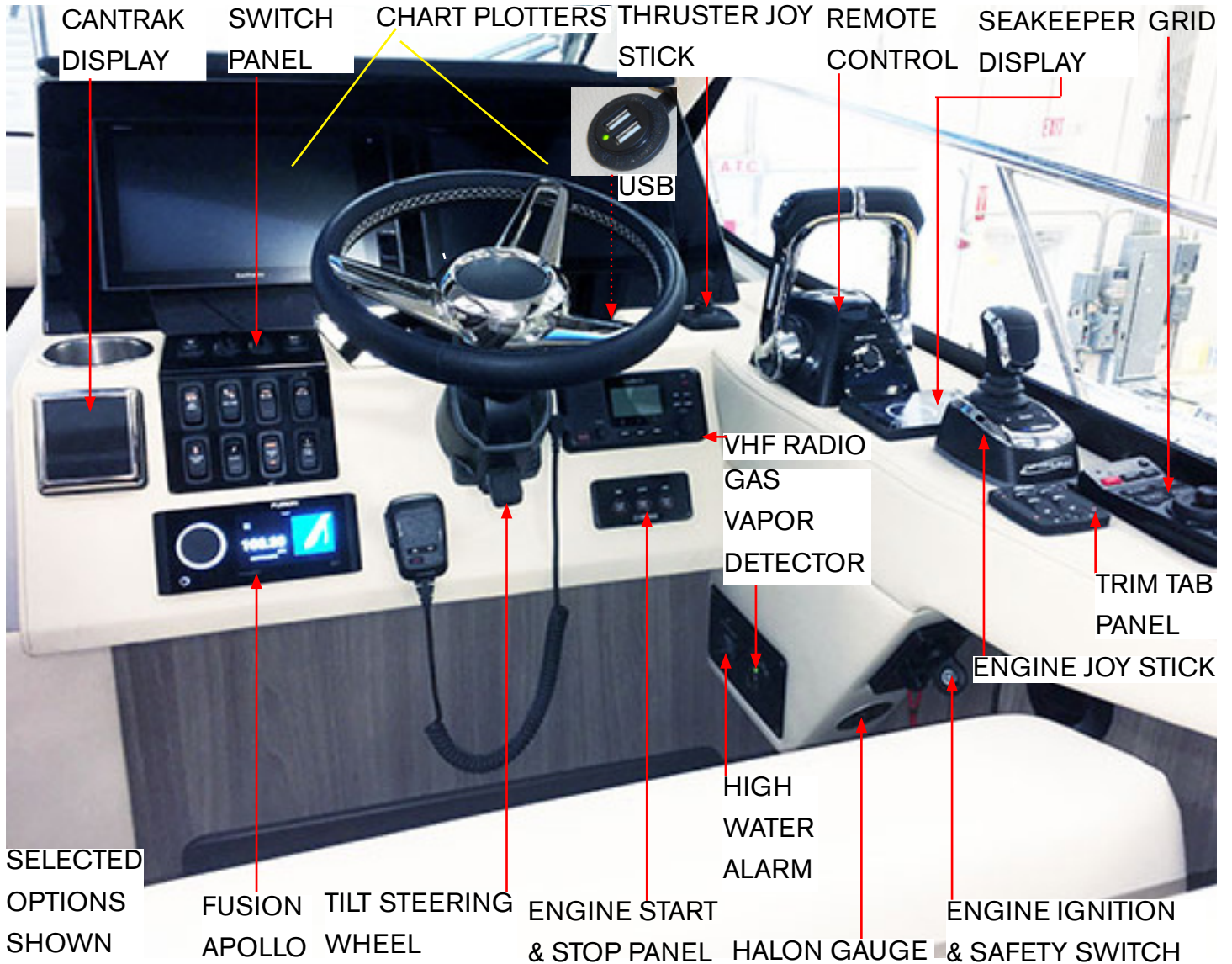

Helm Overview

The helm station is equipped with the ability to monitor engine functions through a “Glass Cockpit” or Garmin chart plotter. Close observation of the digital display is recommended throughout the trip as you can split the screen to accommodate GPS functions along with monitoring basic engine systems including fuel usage and hours for maintenance cycles. This works in addition to the outboard engine manufacturer’s alarm system.

Refer to the systems chapter for additional information. Also, check each component manufacturer’s operation manual.

Note that select items above may be optional and may not be installed on your vessel.

Chart Plotter Engine Monitoring Displays



Typical Gauge Display Shown

A Garmin single screen chart plotter is standard equipment on your outboard vessel. The unit displays many GPS features along with the ability to monitor engine system functions including engine revolutions per minute (rpm's), GPS speed, voltage, fuel flow rate, trim, and temperature along with tracking engine hours.

A Fusion display screen offers control of media/audio functions.

Note that the Garmin and Fusion circuitry use individual DC sources to power up the system. The key switch does not power up these 2 systems.

1. To power up the plotter(s) installed activate the electronics breaker on the panel. Next, press the "on" button located on the plotter display panel.

2. The function AV/Gauges,Controls will appear as one of the menu choices. Press the box. Another screen with engine will appear.

3. Press the engine box and the engine gauge displays will appear (oil pressure is engine code driven only).



A Garmin dual display chart plotter may be installed on your outboard vessel. Typically, the unit displays many GPS features along with the ability to monitor engine system functions including engine revolutions per minute (rpm's), GPS speed, voltage, fuel flow rate, trim, and temperature along with tracking engine hours.

Fusion uses its own display screen on the chart plotter for media/audio controls on the vessel.

Note that the Garmin and Fusion stereo circuitry use individual DC sources to power up the system. The key switch does not power up these 2 systems.

1. To power up the plotters activate the electronics breaker on the panel. Next, press the "on" button located on each plotter display panel.

2. The function AV/Gauges-Controls will appear as one of the menu choices. Press the box. Another screen with engine will appear.

3. Press the engine box and the engine gauge displays will appear (oil pressure is engine code driven only).

Note that the dual screen offers the operator the ability to follow his navigation on one full screen while monitoring his propulsion units vital signs on the other full display.

Garmin “Grid” Remote Device



TYPICAL
“GRID”
REMOTE

This remote input device provides full control of single or dual chart plotter systems as installed on your vessel. Featured are a rotary knob and joystick control which provide navigation through various on board menus and screens including Fusion entertainment, navigation, auto pilot, sonar fish finder, radar, and others.

The “Grid” uses a NEMA 2000 network backbone thru a network cable to communicate with numerous devices.

In addition to the factory settings an individual can add new devices to the chart plotter and extend the existing system thru the “Active Captain App” and a mobile device.

For further information refer to the glass cockpit owner’s manual which can be downloaded on-line and printed. Also, this manual can be selected and viewed on the plotter screen per instructions on the previous pages.

Quick Start- Garmin “Grid” Remote Device

For basic functions follow the steps below to energize the grid device. Also, select buttons are noted.

1. Energize the boat battery system by using the battery panel (helm station).
2. Activate the helm electronics breaker.
3. Turn on the appropriate chart plotter(s) by activating their individual power button. Wait for the screens to display.
4. Power up the grid device by pressing the button on the top right face of the device. Grid device is now ready to use.

Button Tips:

Select Home from any screen to return to the Home screen.

Select Menu to open additional settings regarding that screen.

Select Menu to close the menu when finished.

Select Back to return to previous function.

Select STBY to engage auto pilot in standby mode. Green icon lites when auto pilot is engaged.

Select SOS to mark the location. See plotter owner’s manual for additional SOS type information.

Select + or - bottom grid buttons to magnify or to de-magnify screen size.

Engine Starting/Stopping Outboards/Earlier

Overview

The following general information covers basic starting and stopping of your outboard engine(s). Read and understand all information on remote controls, fueling and operational procedures. Pay particular attention to all safety labels found here. Refer to your outboard engine owner's manual for further in-depth propulsion system starting, operating and safety information.

Ignition Panel



YAMAHA TRIPLE ENGINE STARTING PANEL

The ignition panel along with the key switch and safety lanyard panel are used to start the engines. Always connect the safety lanyard to a belt or secure piece of clothing. *Note that the safety lanyard must be secured or the engine will crank but not start.*

Make sure the batteries are activated at the battery activation panel. Start engine only in a well ventilated location to avoid CO buildup.

Make sure passengers and boat operator are seated with life jackets on and your passenger load is balanced.

Locate the remote control handles in the neutral position. Advance both neutral throttle positions as instructed in the engine owner's manual. Keep passengers seated and away from controls. Power up the plotter and go to the engine screen in order to monitor engine functions especially oil pressure and temperature after the engines have started.

Starting Engines



YAMAHA IGNITION PANEL W/ LANYARD

To activate the start-stop panel turn the key switch to the "on" position at the ignition panel shown above. All three start-stop buttons are now energized. At this point press one of the "start" buttons, The engine will now crank over and start.

Once the first engine starts press the other two "start" buttons one at a time to crank and start the remaining two engines.

Check for water at each of the engine pilot holes for a steady stream. If no water stream stop that engine and check for debris at the pilot discharge hole or blockage at the lower unit water inlet.

Let the engines warm up at idle speeds for a few minutes before making any headway. Monitor all engine functions on the appropriate chart plotter display screen for acceptable perimeters.

Read and understand the following safety labels!

 **WARNING**

AVOID A POSSIBLE ACCIDENT CAUSING INJURY, DEATH OR PROPERTY DAMAGE! BEFORE STARTING ENGINE ENSURE THE BOAT IS SECURE TIGHTLY AT THE MOORING AND THERE ARE NO SWIMMERS IN THE AREA.

 **WARNING**

AVOID A POSSIBLE ACCIDENT CAUSING INJURY, DEATH OR PROPERTY DAMAGE DUE TO A RUNAWAY VESSEL! BEFORE STARTING ENGINE ENSURE THE SAFETY LANYARD IS ATTACHED TO AN ARM OR LEG OR A SECURE PLACE ON YOUR CLOTHING.

 **WARNING**

AVOID A POSSIBLE ACCIDENT CAUSING INJURY, DEATH OR PROPERTY DAMAGE! AVOID ACCIDENTALLY DISENGAGING THE SAFETY LANYARD WHILE UNDERWAY AS IT CAUSES LOSS OF STEERING CONTROL. ALSO, THE BOAT COULD SLOW QUICKLY CAUSING EQUIPMENT AND PASSENGERS TO BE THROWN FORWARD.

 **WARNING**

AVOID POSSIBLE INJURY OR DEATH! OUTBOARDS EMIT EXHAUST GASES WHICH CONTAIN CARBON MONOXIDE, A COLORLESS, ODORLESS GAS WHICH COULD CAUSE BRAIN DAMAGE OR DEATH WHEN INHALED. KEEP ALL AREAS OF VESSEL WELL VENTILATED. KEEP PEOPLE OUT OF WATER WITH THE ENGINES RUNNING. DO NOT IDLE ENGINES FOR EXTENDED PERIODS WHILE IN MOORING.

Failure to perform proper warm-up will shorten life of engine. After warm-up ensure coast is clear and passengers are sitting down with life jackets worn before making headway.

Stopping Engines

To stop engines make sure the control is in the neutral idle position before attempting to shut down the engine(s). Always let the engines idle for a few minutes after a hard run.

Then press and hold the start/stop button for each engine or turn the ignition key to the "off" position which will instantaneously stop all 3 engines.

Remote Controls

Read the following basic information covering shift/throttle controls. Refer to the outboard engine owner's manual for more detailed operational information including trim/tilt functions and safety labels. Read and understand all operation and safety information found in the outboard owner's manual and here before using the (DEC) digital electronic control.

Note to practice docking operations with the remote control in a controlled environment to learn the basic control functions before cruising.

Overview

Triple outboard vessels use a drive-by-wire twin binnacle control for shifting and throttle operations. The remote control handles control forward, neutral, and reverse outboard shifting operations for triple engines. The control handles can be used independently for maneuvering in tight quarters. The control features power trim up and down functions for each outboard along with automatic RPM synchronization. There is an integrated redundancy system and a separate Electronic Control Unit (ECU) for each outboard.

There is a master trim button on the port remote control handle that operates all 3 outboard trim/tilt functions simultaneously as one unit.

In addition, note the user operated engine selector switch that permits the operator to customize which engines provide forward thrust (port throttle lever controls both the port and center engine via the selector switch), while only the outer-most engines provide reverse thrust for improved vessel control and handling while the center engine is neutralized during reverse.

YAMAHA DIGITAL ELECTRONIC CONTROL



DEC Remote Control Description

1. Control Lever- The port lever controls shifting and throttle operations for the port and center outboard. The starboard lever controls shifting and throttle operations for the starboard outboard.

2. Throttle Only Switch- The throttle only switch can be used only when the control lever is in neutral. To use in neutral press and hold the switch while moving the throttle control forward. Release the switch when the control active indicator starts blinking. During this blinking time you can increase the engine idle either for faster or slower rpm. You can duplicate throttle only positions also in reverse. When the above actions are completed and the control handle resumes the neutral position the active indicator light will remain lighted. The control at this point is ready for shifting to forward or reverse gear positions.

3. Control Active Indicator- This indicator shows that the control is in the operation mode.

- Lighted denotes that the shift and throttle control levers are ready to activate.
- Blinking (in neutral only) denotes that the shift is not operable but the throttle only is operational.
- Off- Shift and throttle are not operational.

4. Control Alert Indicator- This device lights when there is a problem in the connection between the digital electronic control and the outboard unit. If this lights contact your nearest authorized Yamaha outboard dealer or your closest Regal dealer.

5. Engine Selector- This button when depressed in the upper quadrant will apply all control functions to all three outboards.

When the port/starboard quadrant is depressed all control functions will affect port/starboard engines but not the center outboard unit.

When the center quadrant is depressed all control functions will affect the center engine only. Other outboard units are inactive.

6. Trim /Tilt Switches- There are three individual trim/tilt switches that control the outboard units.

- To raise up the vessel bow (trim out) press the switch “up” quadrant.
- To lower the vessel bow (trim in) press the switch “down” quadrant.

Remember that these individual switches affect trimming on one outboard unit only. Be careful not to over or under trim as this can result in unsafe bow up or bow down positions.

7. Master Trim/Tilt Switch- This switch trims or tilts all outboard units simultaneously. If all outboard units are equal in starting trim this may be a way to achieve a faster planing position. The individual trim switches can be used in conjunction with the rpm plotter display to fine tune the vessel for the best ride in the conditions that currently exist on the water. Usually as the rpm increases on the plotter display the vessel moves to a “best ride” position of less drag, greater stability and efficiency. After practice the operator will be able to reach a desired planing position in a brief period of time.



WARNING

AVOID A POSSIBLE ACCIDENT CAUSING INJURY, DEATH OR PROPERTY DAMAGE DUE TO EXCESSIVE TRIMMING UP OR DOWN! STEERING THE VESSEL AND BOAT INSTABILITY CAN INCREASE ACCIDENT POTENTIAL. IF CRAFT IS DIFFICULT TO STEER OR FEELS UNSTABLE SLOW DOWN AND READJUST THE TRIM ANGLE.



WARNING

AVOID POSSIBLE INJURY, DEATH OR PROPERTY DAMAGE! BEFORE SHIFTING THE REMOTE CONTROL ENSURE THERE ARE NO PEOPLE OR OBSTACLES IN THE WATER NEAR THE VESSEL!

Remote Control Tilting Up Function

The tilt up position comes into play when the outboard is stopped and the lower unit is tilted beyond normal trim positions or completely out of the water. Normally this high angled position is used to check/change the propeller, for extended mooring periods in shallow water, and for inspecting or replacing outboard lower unit anodes.

Be sure to read and understand the safety labels regarding the tilt process here and in the outboard manufacturer's owners manual before operating the outboard engine.

Use the following procedure to achieve a tilted position:

1. Make sure the remote control is in neutral.
2. Press the trim/tilt switch "up" for the appropriate engine at the remote control until the outboard motor has tilted up completely.
3. Set the tilt support lever to accommodate the engine (see photo below).
4. Once the engine is supported with the tilt support lever press the power trim/tilt switch "down" to retract the trim rods.



Remote Control Tilting Down Function

To tilt down the engine with the tilt support lever in place do the following:

1. Push the trim/tilt switch "up" until the outboard motor is supported by the tilt rod and the tilt support lever is free.
2. Release the tilt support lever (See photo below).
3. Push the trim/tilt switch "down" to lower the outboard engine to the desired position.



Tips On Trim/Tilt Usage

1. Never tilt the outboard excessively in shallow water when the engine is running.

Severe overheating damage can occur as cooling components may end up out of the water.

2. If equipped, never use the switch on the bottom cowling area to adjust the trim while the boat is making headway.

3. Use caution when trying alternate trim positions as the vessel can become unstable and a loss of steering may result.

4. Before attempting to trim/tilt the engine make sure nobody is in the water or near the engines.

5. Make sure the trim rods retract completely during mooring to prevent corrosion, barnacle growth, and salt water damage.

6. Do not tilt the outboard engine without using the tilt support lever.

7. When stored for extended periods never get under the outboard motor when it is tilted.

8. Should the trim/tilt functions not raise or lower the outboard there is a valve that can be turned manually to lift the unit. Refer to your outboard manufacturers owners manual for additional information.

Trim/Tilt Safety Labels



WARNING

AVOID POSSIBLE INJURY OR DEATH
FROM THE OUTBOARD FALLING!
NEVER GET UNDER THE OUTBOARD
ENGINE WHILE IT IS TILTED.



WARNING

AVOID POSSIBLE INJURY OR DEATH
FROM CRUSHED BODY PARTS!
BE SURE PEOPLE ARE CLEAR OF OUTBOARD
MOTOR WHEN ADJUSTING TRIM/TILT ANGLE.

Remote Control Shift/Throttle Functions- Typical



Shown in the neutral position with throttle control at idle . This is the detent position for starting and stopping the engine(s).

The port lever controls shifting and throttle operations for the port and center outboard. The starboard lever controls shifting and throttle operations for the starboard outboard. *Note that when the shift handles are opposite each other during maneuvering operations like docking the center outboard is inactive .*

The throttle only switch can be used only when the control lever is in neutral. To use in neutral press and hold the switch while moving the throttle control forward. Release the switch when the control active indicator starts blinking. During this blinking time you can increase the engine idle either for faster or slower rpm. You can duplicate throttle only positions also in reverse.

When the above actions are completed and the control handle resumes the neutral position the active indicator light will remain lighted. The control at this point is ready for shifting to forward or reverse gear positions.



Pushing the throttle control lever forward from the neutral 12 o'clock position to the 1 o'clock position will engage forward gear with minimal throttle. From the 1 o'clock position to the 3 o'clock position, the vessel is in forward gear with differing levels of throttle selections.



Pulling the throttle control lever back from the neutral 12 o'clock position to the 11 o'clock position will engage the reverse gear with minimal throttle. From the 11 o'clock position to the 9 o'clock position, the vessel is in reverse gear with differing levels of throttle selections. Review the earlier section of this chapter, refer to the Yamaha owner's manual or contact your closest Regal dealer for further information on remote controls.

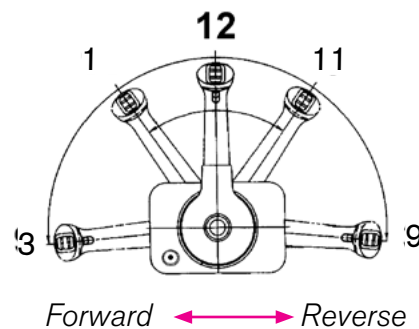

Profile Of Typical dual Engine Control Lever Showing Five Positions



WARNING

REDUCE POSSIBLE INJURY OR DEATH DUE TO LOSING CONTROL AND EJECTION FROM VESSEL, SWAMPING OR SYSTEM DAMAGE. NEVER SHIFT INTO REVERSE WHILE MAKING HEADWAY AT PLANING SPEEDS.

Follow these points when shifting:

- DO NOT shift quickly from forward to reverse gear positions. Drive system damage may occur.
- DO NOT “pump” the throttle in neutral as it is normally not needed since today’s engines use an enrichment valve system that requires very little starting throttle.
- DO NOT try to shift into forward or reverse gear at high rpm’s. Personal injury, drive system, or property damage may result.
- Only use idle throttle positions when docking or maneuvering in tight quarters.
- Wear your safety lanyard at all times.
- Never shift the controls with the engine not running. Control, linkage, and/or outboard drive gear damage may occur.
- For more information refer to your outboard engine manufacturer’s manual before operating the remote control.

Safety Lanyard (Interrupter Switch)

The safety lanyard (found on the ignition panel) sometimes called an interrupter switch is attached to the operator and the ignition panel. Should the operator lose control of the vessel and become dislodged from his/her seat or fall overboard, the lanyard will shut the engine off. Make sure the lanyard is installed to a secured part of clothing or body limb before operating the vessel.



WARNING

TO PREVENT BODILY INJURY OR DEATH!
MAKE SURE THE COAST IS CLEAR OF ALL SWIMMERS OR OBSTACLES IN THE WATER BEFORE USING THE REMOTE CONTROL SHIFT FUNCTION!



WARNING

IF THE LANYARD IS IN THE “OFF” POSITION, THE ENGINE WILL CRANK OVER BUT WILL NOT START. ENSURE SAFETY LANYARD IS ATTACHED CORRECTLY AND SWITCHED TO THE RUN POSITION ON THE IGNITION PANEL.



WARNING

LANYARD MUST BE ATTACHED TO THE OPERATOR WHILE THE ENGINE IS RUNNING. A QUALIFIED OPERATOR MUST BE IN CONTROL AT ALL TIMES. READ AND UNDERSTAND THE OWNER’S MANUAL BEFORE OPERATING VESSEL.

Joystick (Auto Pilot)

Overview

As an option you may have a joystick installed on your vessel. The joystick permits the vessel to maneuver in tight mooring situations even made more opportunistic with wind and water conditions such as current.

The joystick permits the boat to move 360 degrees and features a boost feature. The joystick is spring loaded so it always returns to its home (center) position. When the joystick is active and in the home position the throttles are at idle and all engines are in neutral.

Read and understand the Optimus 360 Joystick Guide before operating the joystick along with any safety labels. Always start practicing joystick maneuvering in a clear and traffic free water environment before venturing out on a long cruise.



OPTIMUS 360 JOYSTICK

The joystick system uses a color display called the Cantrak. It is used to display the following system status and fault auto pilot notifications:

1. Current system operating conditions.
2. Handles system faults:
 - a) Displays system warnings in the case of a fault.
 - b) Sounds an audible alarm in case of a fault.
 - c) Displays instructions for the operator in case of a fault.
3. Allows changes to the system basic settings.
4. Provides diagnostic and system information.

Note the single station display below. The display shows the port and starboard outboard units only.



The Cantrak comes with a plastic cover to protect the screen from the sun. When system is not in use, place cover over the display.

Joystick Features/Start-Up Information

1. Handle- When energized and moved toward the bow the vessel travels forward. When energized and moved toward the stern the vessel travels in reverse. The neutral center position is the home or start-up location.

When energized and rotated partially to starboard the vessel will travel in a starboard heading. When energized and rotated partially to port the vessel will travel in a port heading.

When energized and moved directly to the starboard or port direction the vessel will go sideways.

Note that the joystick is proportional and guided in each axis; the more joystick is moved the more throttle is applied.

2. Take Command- This must be energized by depressing the Take Command button to operate the joystick. When energized an LED light will appear solid blue. While the joystick is active the turning resistance of the steering wheel will increase as a reminder to the operator that the joystick is still active.

To deactivate the joystick depress the Take Command button and it will cease to be active. Another way to deactivate the joystick is to push both remote control handles forward or reverse which automatically switches vessel control back to the remote controls.

3. Boost- This feature which can be applied anytime the joystick is active. It increases power to the engine and can be very advantageous in current and wind conditions especially in cramped docking situations. When energized an LED light will appear blue.

4. Button A- With an active station this button once depressed will hold the boat in that position within a 3 meter radius. One engine is in forward and the other engine is in reverse. Middle engine is in neutral. This feature is great for fishing. You can maintain the vessel in position for casting without the need for anchoring. The A position uses less gas and is quieter with less shifting to hold that fishing spot.

5. Button C- With an active station this button once depressed will hold a vessel pointing in one direction and will drift according to wind and current through the joystick or the Cantrak display. This is great for fisherman who want to drift over a certain structure without changing direction and tangling lines.

6. Buttons A & C- With an active station when these buttons are both depressed simultaneously will hold vessel position and heading. This is great for waiting for a bridge to lift, or a spot to open at a marina gas dock or for fishing. This mode will hold the vessel within a 3 meter radius and 10 degrees of heading.

Joystick Usage Tips

1. Remember that the control head must be active at the helm with the joystick and the remote control handles must be in neutral and idle.
2. There is a short shift delay integrated into the system when returning from any gear to neutral. This permits bumping the handle to get a bit more motion in the same direction without causing excessive engine shifting. This delay is gone if the action passes the home area in the opposite direction so you can if desired stop the boat immediately.
3. Plan out your joystick maneuvers before approaching the target; keep it simple and know the boat's limitations.
4. Make it clear to the system what your intentions are to be. Do not make slight movements off of the neutral position. For example: If you desire the vessel to move to starboard, move the joystick well along the starboard axis.
5. Moving the joystick control handle port/starboard, but will not steer the vessel (change heading) Rotating the handle steers and rotates the vessel.
6. It is recommended to return to the center position when switching between primary operational modes.
7. Always practice maneuvers in open water before attempting close quarters docking. This will enhance your understanding of the primary operational modes while underway.



WARNING

TO PREVENT BODILY INJURY OR DEATH!
MAKE SURE THE COAST IS CLEAR OF ALL SWIMMERS OR OBSTACLES IN THE WATER BEFORE USING THE AUTO PILOT SYSTEM JOYSTICK OR CANTRAK DISPLAY.



WARNING

TO PREVENT BODILY INJURY OR DEATH!
NEVER LEAVE THE HELM STATION UNATTENDED.



WARNING

TO PREVENT BODILY INJURY OR DEATH!
MAKE SURE ALL STEERING COMPONENTS ARE IN PROPER WORKING CONDITION BEFORE ENTERING THE WATERWAYS.



WARNING

TO PREVENT BODILY INJURY OR DEATH!
ALWAYS READ AND UNDERSTAND THE AUTO PILOT OPERATION INSTRUCTIONS COMPLETELY BEFORE ENGAGING THE AUTO PILOT MODE.

8. Read and understand the joystick control system before attempting to use the components. Also be aware of all safety precautions and system safety labels as seen above and in the product literature.

Engine Power Steering

Your outboard boat features as standard equipment an electronic helm “power steering” system. We will briefly describe the system and display various parts and their function.

Overall this system lends itself to single and multiple outboard installations well with an effortless “power steering” feel. In addition, this system features light friction at low speed and higher friction at higher speed to provide a higher degree of maneuverability. Furthermore, it can be programmed for toe-in and toe-out settings which provide optimum vessel performance.

The main system components are the electronic helm, electrical connection board, hydraulic steering pump and “smart cylinder”. Note the adjacent drawing which shows normal system components. For service contact your closest authorized Regal dealer.

The hardware at both the helm and engine must be checked regularly for tightness, lubrication, and leaks. *Note to check the steering system for full steering to port and to starboard before disembarking.*

Electronic Helm

The electronic helm features a sport steering wheel and several tilt positions for maximum control taking into account individual driver needs and body types. The steering wheel motion can be adjusted to various lock to lock turning positions, along with the ability to adjust wheel friction tension through the cruising rpm range to afford the greatest driver control and feel at the helm.

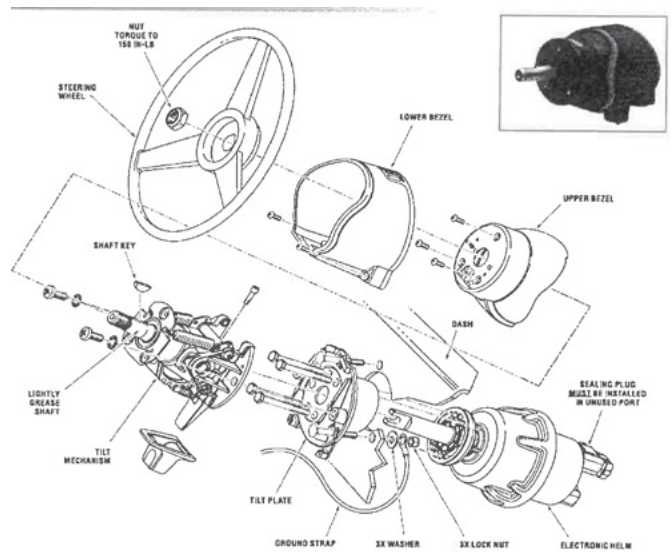

OPTIMUS SYSTEM OVERVIEW O/B TWINS SHOWN

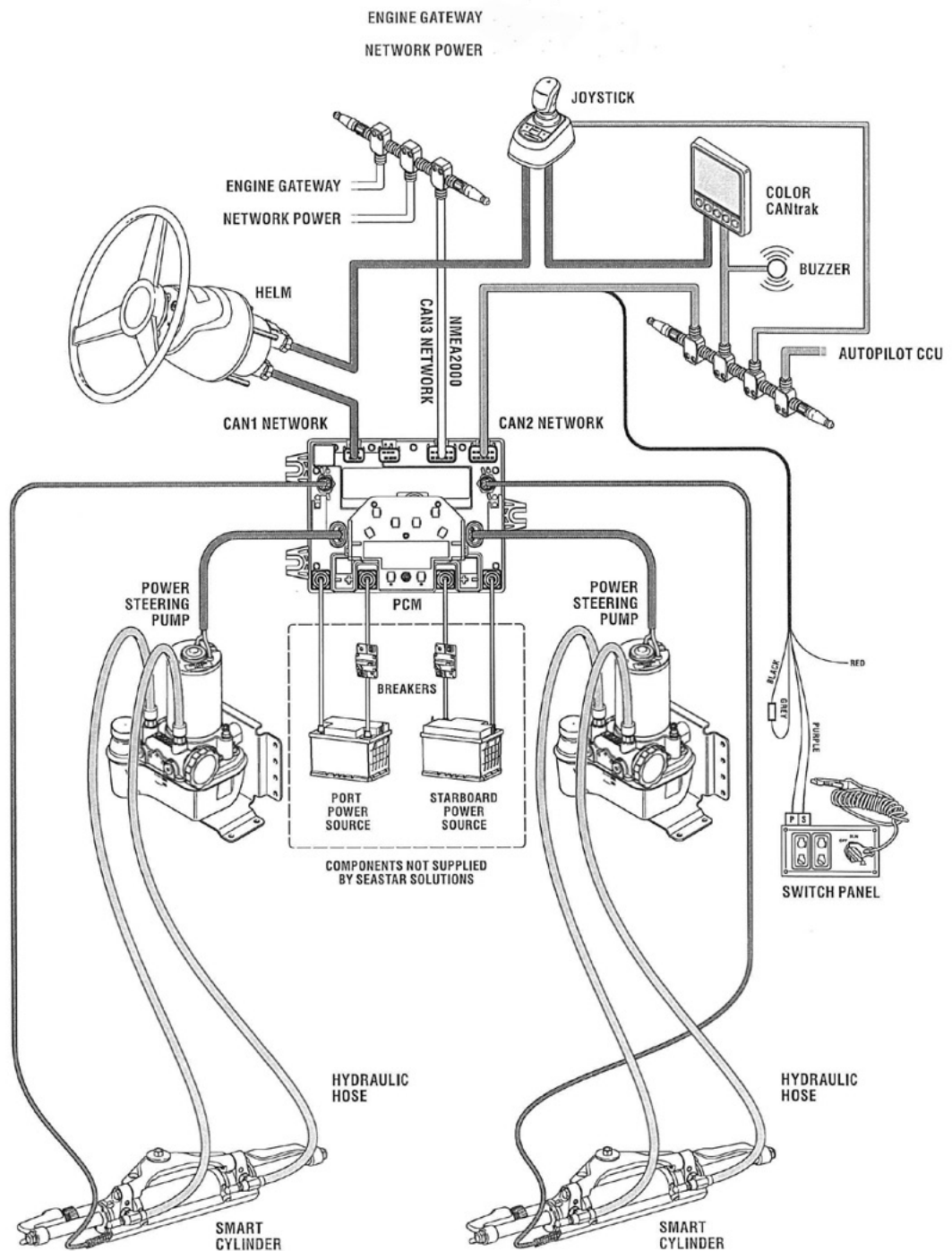

© 2013 SeaStar Solutions

* Note that the center engine uses a tie bar; replicates steering cycles of port and starboard units.

Power Steering Wiring

The electronic power steering is an on demand system using minimal power. The system uses two 80 amp breakers (one per starting battery) mounted on the hull side. The illustration below shows a typical multi-engine steering setup. *Note that the center outboard uses a tie bar and does not require its own power steering pump, hoses or wiring.*

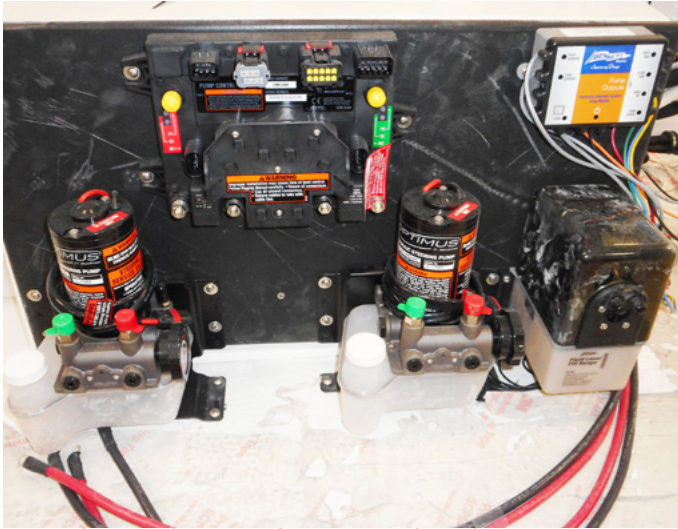

TYPICAL POWER STEERING BOARD

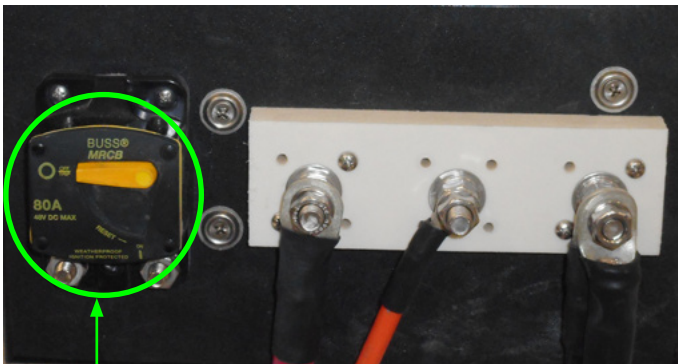

TYPICAL POWER STEERING PUMP BREAKER.

Hydraulic Steering Pump

Located in the bilge attached to the hot water heater is the steering system wiring/hydraulic pump board. Each pump controls the port or starboard steering cylinder. The Optimus steering system uses the HA5482 EPS power steering fluid. Do not use any substitutions. It is a good idea to have extra fluid, funnel and cloth on board for emergency filling of the system. *Also, note that there is a service valve located on each pump.*

It allows for manual realignment of the engines during service or a system fault. Use the decal information as needed for manual realignment situations. Engine(s) must not be running while performing these realignment procedures. Refer to the steering system literature for further information on manual realignment or contact dealer.

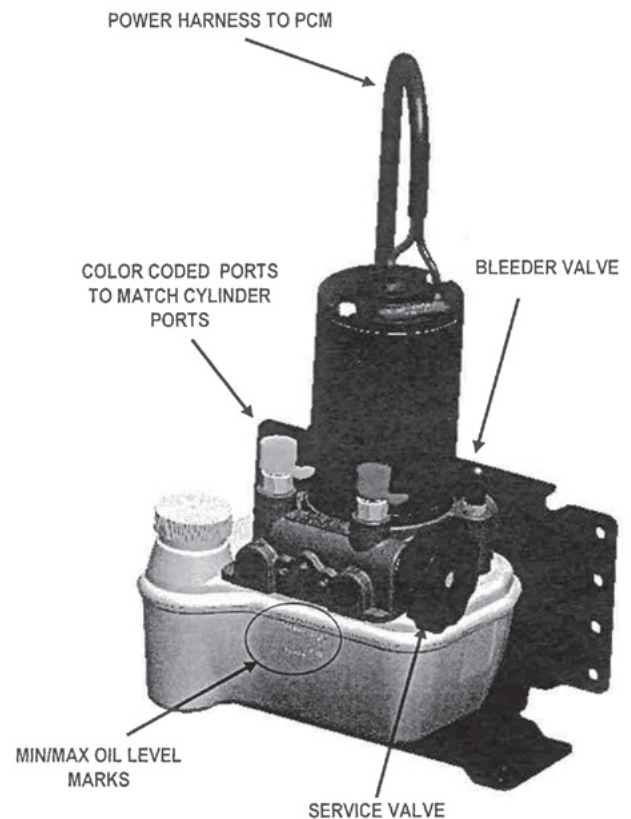

Smart Cylinder

Located on the front of each engine is the steering smart cylinder. It is foot printed with redundant sensors to determine the steering response to the wheel movement. If one sensor should fail there are back-up ones on each cylinder. The stainless steel cylinder includes ORB fittings with bleeders to purge air as needed.

Remember that the center engine does not require a smart cylinder as it uses a tie bar.

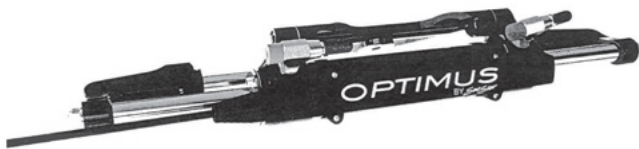

Smart Cylinder Description

For information purposes components used in the smart cylinder are shown in the drawing. This illustration may be useful too for ordering needed parts as well as a troubleshooting breakout. Contact your closest Regal dealer to order parts.

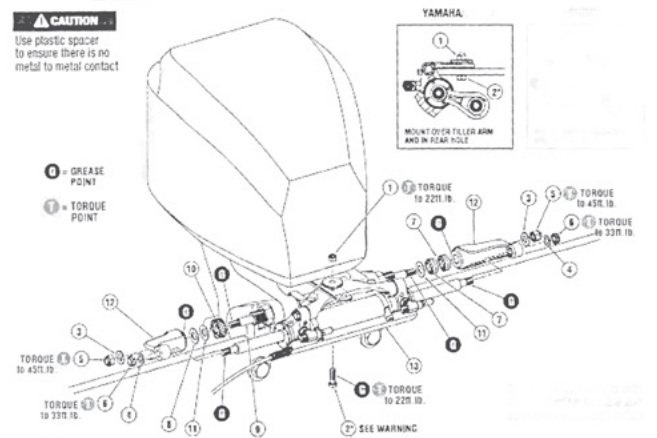

ITEM	PART #	QTY	DESCRIPTION
*1	112529	1	Nut, 3/8" NF Nylok® SS
*2	113225	1	HHCS 3/8" UNJFX 1.35 HSS
3	731625	2	Washer, Flat, 7/16" SS
*4	731720	2	Nut, 7/16" NF Nylok® SS
5	202027	2	Washer, Flat, 1/2" SS
*6	192126	2	Nut, 1/2" NF Nylok® NI Plate Br
7	995876	2	Spacer, Thick
8	996689	1	Spacer, Thin

ITEM	PART #	QTY	DESCRIPTION
9	730229	1	Support Rod
10	828085	1	Adjusting Nut & Screw, SS, Teflon Coated
11	202300	2	Washer, Flat, 5/8" SS
12	839120	2	Support Brackets
13	907099	1	SmartCylinder (EC5310) or 907033
14	728994	1	Spacer, Medium (size 1955 to 1998)
15	113350	1	HHCS 3/8" NF x 1-1/2" SS

Diesel Stern Drive Propulsion & Controls-Part C

Regal Owner's Manual

Your Regal owner's manual covers *basic* operations of the propulsion systems as they relate to the running of the vessel but it should not be thought of as a shop manual. Included are basic maintenance tips regarding diesel propulsion systems. For more specific information refer to your Volvo diesel operator's manual. Pay particular attention to sections relating to the diesel fuel system as it is the life line of the diesel propulsion system.

 **WARNING**

PREVENT INJURY OR DEATH!
READ ALL MANUFACTURER'S STERN DRIVE
ENGINE AND PROPULSION OWNER'S
MANUALS BEFORE OPERATING
YOUR VESSEL.

Stern Drive Diesel Engine Owner's Manual

It is important that you read your Volvo diesel stern drive engine manual carefully and become completely familiar with the operation as well as necessary maintenance on the engine and propulsion systems before operating the vessel. Pay careful attention to the sections on winterization if you live in freezing climates. Extensive damage can result if winterization procedures are not followed properly. Contact your closest authorized Regal dealer for information regarding technical issues and parts.

For more specific information refer to your Volvo diesel operator's manual.



VOLVO D4 DIESEL OVERVIEW

Engine Break-In Period

All propulsion systems require a pre-determined “break in” period. For the Volvo D4 diesel this “run in” period is a duration of 10 hours. During this time the engine should not be run at a full load condition for extended periods. Various engine load and speed conditions assist the internal engine parts such as bearings, valves and piston rings to “seat” properly which will help ensure a longer engine life. See operator’s manual for further information.

During the “break in” period it is necessary to check the engine oil more frequently since it is normal that the engine will use more oil. If engine oil is required be sure to check the engine manual for proper grade and viscosity.

Check the maintenance schedule in your engine owner’s manual and contact your Regal yacht dealer to set up the first maintenance inspection. Normally the engine oil, filters, and drive oil inspections and maintenance are performed during this inspection along with other components.

Notwithstanding, during this break-in period become familiar with the vessel’s maneuvering and seakeeping qualities at different speeds, wave and load conditions along with wind and tidal influences. During this time period learn about regulations that effect your area of cruising by contacting the relevant authorities. If needed take a boat safety and/or driver’s course.

Remember as the captain of the vessel you have the legal responsibility of safety and legal regulations for all aboard.



Diesel Fuel System

Diesel fuel properties have changed in recent years due to the way the product is processed today at the refineries. A couple of decades ago diesel fuel, gasoline, home heating oil among other distillation products were processed by heating the crude oil. At different boiling temperatures, various parts of the crude oil were evaporated then condensed sending the final products to storage tanks for distribution. The distillation process generally produced stable diesel fuel with a storage life of several months. Around 50% of the oil left over from the distillation process was designated as heavy fuel oil being used for ship's, power plants, and industrial products such as nylon, plastics, and asphalt.

Refining crude oil today has changed dramatically due to increased demand for the product. A process called "chemical cracking" has allowed the refiner to extract more of the lighter distillates from the crude oil leaving about 16% of the residual as heavy fuel oils. Lowering the diesel fuel sulphur levels due to environmental concerns has led to further fuel instability. Due to these newer methods of refining diesel fuel is far less stable than the older distillation process.

There are different theorems on defining fuel system "algae" and how it develops in the vessel's fuel tank. Algae is slang for the fungus that grows in fuel tanks.

One school of thought isolates two of the key fuel components. Asphaltites and paraffins in this premise begin to oxidize and re-polymerize forming clusters resulting in fuel tank "algae". As these clusters "grow" in size they cling themselves to tank walls and baffles.

Others state that "algae" is formed when water condenses in the boat's fuel tank. Water can enter the vessel's fuel tank through the fuel pumping process at the fuel dock since their tank may already be contaminated with algae-micro organisms. Once inside the tank these algae-microscopic organisms from the plant kingdom are able to combine with water and diesel to form tank sludge.

Keeping tanks free from water, dirt and micro organisms is almost impossible, but luckily you can eliminate them before they reach the engine and fuel injectors through the use of primary and secondary fuel filters. Algae ends up in the fuel system once the boat is running which breaks up the tank "algae" and/or sludge into mini clusters.

When this condition is present in the marine diesel fuel system the fuel does not combust rapidly as it should resulting in a loss of engine efficiency.

Basically, with either school of thought this "algae" or fuel tank sludge is the result of aging diesel fuel. It can occur in as little as 60-90 days depending on the condition of the tanks and environment where the diesel fuel is stored.

Using diesel fuel in this condition may cause:

- Fuel tank sludge-remove manually/chemically
- Dirty engine oil
- Shortened engine component life
- Smoke emitting from engine exhaust system
- Carbon deposits in the engine
- Incomplete combustion
- Loss of power and performance
- Clogged primary and secondary fuel filters
- Malfunctioning fuel injectors

Solution For Recovering Diesel Fuel Quality

As a Regal yacht owner you have a huge investment in your diesel propulsion system. Being the engines are a key component, keeping the fuel system clean needs to be a high priority.

Following are some possible solutions to help clean up a diesel fuel “algae” problem:

Periodically use a biocide to control microbial activity which can lead to more rapid formation or clustering of solids such as wax and asphalt. Remember that biocides do not prevent microbes from forming but aid in breaking up the clusters. If the vessel is to be stored for over 2 months pour biocide in the semi empty vessel fuel tank. Fill the fuel tank with fresh diesel fuel to prevent condensation build up. Run the boat for a short run to better mix the biocide inside the fuel tank and fuel system before storing the vessel.

1. Always make sure the fuel tank fill cap is securely tightened to prevent any water infusion.
2. Always buy diesel fuel from a marina or fuel dock that moves a large amount of fuel through the pumps. Ask how often the fuel dock pump filters are changed and if their diesel fuel is blended with a biocide. Always carry a couple of extra primary and secondary diesel fuel filters. Use exact replacements in order to match micron filtering capacity.
3. Change both primary and secondary fuel system filters more often due to today’s diesel fuels shorter storage life. Reference your Volvo diesel operator’s manual for maintenance schedules.



TYPICAL LARGE MARINA DIESEL FUEL DOCK

Glossary Of Diesel Fuel Properties

As a Regal yacht owner you have a huge investment in your diesel propulsion system. Diesel fuel is an ever changing commodity these days. This includes the process of refining diesel and regional differences and seasonality effecting diesel additives. Therefore, the following information may be helpful in understanding the many aspects of diesel fuel commonality of product knowledge and language.

Cetane number- This is a measure of a diesel fuel's ability to ignite. An out of range cetane number will provide poor starting and increased hydrocarbon emissions.

Cetane index- This index is calculated from the distillation range and density of the fuel.

Density at 15 degrees C- Low density reduces engine power and increases fuel consumption. Too much density will increase engine power above safe limits.

Viscosity at 40 degrees C- Low viscosity reduces engine power and increases fuel consumption. Excess viscosity will lessen the fuel injection equipment durability.

Aromaticity- Excessive aromatic content will impair exhaust emission content especially particulates.

Oxidation stability- It is a measure of the chemical stability of the fuel, important for biodiesel blends in the 20-30% range.

Sulfur content- It is an inherent factor in fossil fuels. Too much sulfur content will impair the engine and exhaust after-treatment functions and emissions of sulfur oxides and particulates.

Water content- Too much water will cause wear on engine parts, particularly the fuel injection system and corrosion. Water can increase microbial fuel tank growth, which may result in clogging up the fuel filter.

Total contamination- Organic contaminants (fungi, bacteria, etc.) can lead to fuel filter clogging. Inorganic contaminants (dust, rust, sand) can cause severe damage to entire fuel injection system parts.

Cold flow properties- Cloud point is the temperature below which wax crystals begin to form in diesel fuel.

Cold filter plugging point- Lowest temperature at which the diesel fuel still passes through filters.

Pour point- Temperature below which the diesel fuel become semi solid and loses the ability to flow.

Flash point- It is a measure of a fuel flammability; not a measurement for engine operation. It is important for classification of fuels into hazard classes for insurance and transport.

General Maintenance Schedule- Volvo D4 Engine & Propulsion System

The Volvo diesel propulsion package is designed to provide many years of reliability and satisfaction. To keep the unit running at peak performance a service maintenance schedule is recommended. Only basic information is conveyed here. Refer to the Volvo operation manual for detailed information or contact a Volvo authorized service center.

BEFORE EACH OUTING

Engine & Sump- General inspection
Engine Oil- Check Level
Coolant- Check Level
Leaks- Check After Starting Engines
Drive Unit Oil- Check Level

EVERY 14 DAYS

Drive Belts- Wear Check
Seawater Filter- Clean
Battery- Check Electrolyte Level

EVERY 100-200 HOURS OR YEARLY

Engine Oil- Change (1)
Engine Oil Filter- Change (2)

(1) Oil change intervals vary, depending on oil grade and sulfur content of fuel.

(2) Always change the oil filter with each oil change.

EVERY 200 HOURS OR YEARLY

Crankcase Ventilation Filter- Change
Air Filter- Change
Drive Belts- Check Tension
Compressor- Check Oil Level
Seawater Pump- Check Impeller
Sacrificial Anodes- Heat Exchanger
Fuel filters- Change
Paint- Touch-Up As Needed

* (Dealer Items- 3 Following)

* Exhaust & Cooling Hoses

* Hose Clamps- Tighten

* EVC System- Check With Diagnostic Equipment

EVERY 400 HOURS OR YEARLY

Drive Unit Oil - Change
Drive Unit- Corrosion Protection- Check Anodes

EVERY SECOND YEAR

Coolant- Change

EVERY 400 HOURS OR YEARLY

Drive Unit Oil - Change
Drive Unit- Wear Check Propeller & Steering

EVERY 600 HOURS OR ONCE EVERY 5 YEARS

Turbocharger- Inspect & Clean
Drive Unit- Wear Check Propeller & Steering

Engine Ventilation System

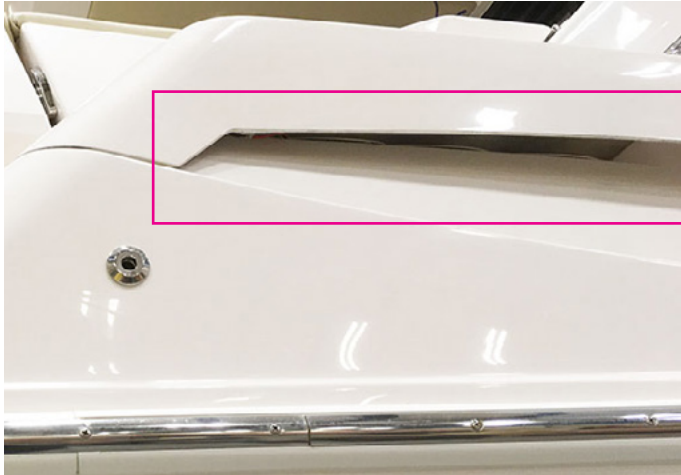

With diesel engines large amounts of air are required to perform the combustion process. The higher the revolutions per minute of the engine the more air is required to meet the demand. Since diesels compress the air at a much higher ratio than similar gasoline models that require a spark in the process the chance of explosion or fire is much lower with diesel power. Therefore, it is not necessary to force the exhaust from the sump with a powered ventilation system like the gas engine.

Diesel engines exhaust large amounts of incoming air by mixing it through the combustion process and by forcing the air through the engine exhaust system into the water. The same deck cowlings are used to funnel incoming air for combustion. The remaining air exits through the cowlings into the atmosphere. This “breathing cycle” occurs naturally within the diesel with more oxygen being required as throttle speeds are increased.

As part of diesel maintenance, ensure the cowlings are free of debris including animal nests such as wasps and birds. Check and replace the diesel engine air filters as required. Note that the diesel air filter can not be cleaned so scrap it and replace according to maintenance schedules. Note: Never modify or obstruct any part of the natural or if installed power ventilation systems.

Engine/Generator Sea Water Strainer- (Typical)

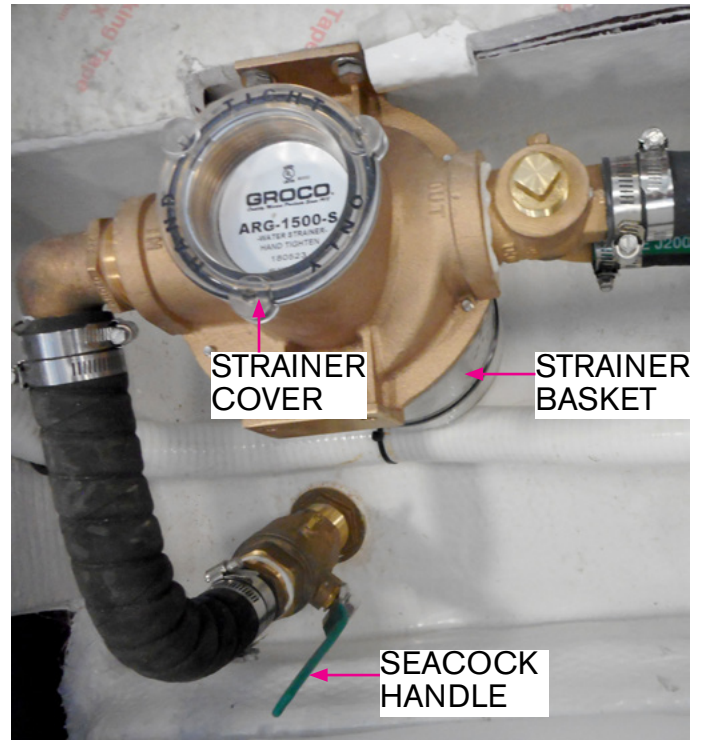

Before servicing an engine/generator sea water strainer make sure the appropriate seacock has been closed to prevent water entering the boat. Remove the strainer by turning counter-clockwise. Then grasp the strainer handle and lift out the strainer basket. If possible blow out the strainer basket with compressed air or use a metal type brush to remove any accumulated material from the screening material.

Check all parts for wear and possible leaks including any gasket surfaces. Do not overtighten the strainer hold down cover which could cause strainer body damage especially on the newer plastic versions. Use original replacement marine parts only. After all parts are reassembled open the seacock and check for leaks.

Once per month open and close the seacock handle several times as this will guard against the seacock sticking in an open or closed position due to corrosion.

Fuel System-Diesel

Overview

Typical Fuel Tank Fill/Vent

Fuel tank fill fittings are normally located on the deck. They are marked diesel. Never pump gasoline in a fuel tank designated for diesel fuel. After fueling close the fuel fill fitting tightly. Failure to secure the fuel fitting tightly may allow water to enter the fuel tank and eventually the engine fuel system. Periodically lubricate the fuel fitting O-ring by coating with clean diesel fuel. This will help keep the O-ring pliable and retain its sealing properties.

The fuel vent serves as a pressure relief for the diesel tank and is a safety overflow device. The vent is usually found close to the diesel fuel fill fitting at the starboard hull side. It has a screen inside which needs to be periodically cleaned. Insects can cause the vent to clog resulting in increased pressure in the fuel system especially noticeable when filling the fuel tank. In extreme clogging cases the fuel will emerge from the fill because the vent is not able to relieve the air in the fuel tank that is being replaced with diesel fuel.

Fuel Filter Maintenance (Typical)Diesel

The Volvo diesel engine features a 2 micron filter near the top of the engine next to the oil filters. This filter assists in trapping fuel debris and water in the fuel system and prevents the above from entering the fuel injectors.

Periodically (see engine maintenance listing) the fuel filter requires draining and eventually changing of the filter. When draining the filter attach appropriate hose to the filter bleed nipple and let fuel drain into a container. Dispose of in an environmentally friendly way.

Refer to the Volvo operation manual for complete draining instructions. After draining follow the procedures for bleeding the fuel system.



For further fuel system filtering Regal installs a 10 micron filter before the engine manufacturer's filter.

This filter captures more contaminants than 30 micron filters along with

stopping water. It extends the life of the fuel system. The filter features a hand operated fuel priming pump (for bleeding) which enhances fuel replacement and air purge. At time of service only the filter element is replaced, the drain and bowl plug are reused. The filter element spins off and on for easy replacement. Corrosion-resistant bowls will not deteriorate from water collection. Also, all gaskets and O rings materials are designed for diesel use eliminating swelling and shrinking.

Note that after replacing element and bleeding system of air always start engine and check for fuel system leaks.

Fuel System Bleeding Tips

The fuel system must be bled if the fuel tank has been run dry, fuel filter elements changed, and after long term storage or inactivity. Refer to the Volvo D4 engine operator's manual and the Racor filter information for step by step instructions or call your closest authorized Volvo or Regal yacht dealer.

Remember there are two filters in the system. One is on the engine and the other is a spin-on type located in the bilge. For bleeding system always have a container to capture fuel lost in the process along with clean rags. After bleeding dispose of all materials in an environmentally friendly way. Never leave stored fuel or contaminated rags on board.

Read and understand the following labels!

NOTICE

TO PREVENT POSSIBLE ENGINE DAMAGE NEVER CONTINUE TO OPERATE AN ENGINE WITH WATER IN THE ENGINE MOUNTED WATER SEPARATOR OR IN-LINE FILTERS.

NOTICE

NOTE THAT ON THE ENGINE MOUNTED FUEL FILTER THERE IS A SENSOR MOUNTED ON THE TOP THAT MUST BE LOOSENED TO DRAIN WATER FROM THE FILTER. DO NOT TORQUE THIS SENSOR MORE THAN 1/2 TURN OR SENSOR CAN BE DAMAGED.



WARNING

TO PREVENT BODILY INJURY DUE TO HIGH DIESEL FUEL LINE PRESSURE NEVER DISCONNECT FUEL LINES!



WARNING

TO PREVENT BODILY INJURY OR DEATH DUE TO FIRE FROM A FUEL SPILL ON A HOT SURFACE ALWAYS LET AN ENGINE COOL BEFORE INITIATING ANY WORK.

Water In Fuel

The Volvo EVC system will alert the operator when there is water in the engine mounted water separator filter.

Drain the engine water separator filter as follows:

- A. Stop the engine and remove the key from the ignition switch for safety sake.
- B. There is a sensor connector piece at the base of the filter which needs to be removed.
- C. Carefully place a container under the fuel filter. Next, unscrew the sensor. Water will first run out as it is heavier than diesel fuel. When a solid flow of diesel fuel runs out screw in the sensor until slight resistance is felt. At that point, tighten the sensor an additional 1/4 to a 1/2 turn. *Note that any additional tightening may damage sensor assembly.* Refit the connector on the sensor.

Engine Oil Check/Change- Diesel

Overview

Read the Volvo diesel operator's manual regarding engine oil type and viscosity recommendations depending on your climate. Be sure to follow the Volvo recommended oil type and viscosity. Check the engine oil before each outing and add the required oil as needed. See photo below.

The engine oil change is an important factor in obtaining engine longevity since impurities enter the crankcase through the combustion process and build up in the engine oil.

With diesel other factors can affect the oil change intervals such as oil grade and sulfur content of the fuel. Never exceed a 12 month span between oil changes.

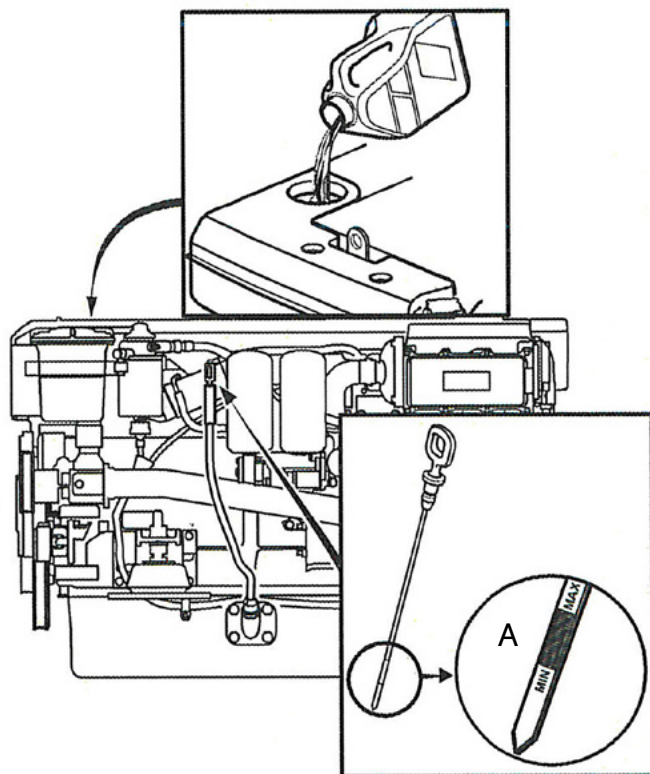

COURTESY OF VOLVO

NOTICE

TO PREVENT POSSIBLE ENGINE DAMAGE
DUE TO FOAMING OIL
NEVER EXCEED THE MAXIMUM OIL LEVEL.
USE ONLY RECOMMENDED OILS.

Note to replace the oil filter with each oil change. Use approved Volvo replacement parts only. Never substitute automotive parts for marine applications.

Checking Diesel Engine Oil

The engine oil must be checked before each outing and must be in the area marked A on the dipstick shown in the diagram. It takes awhile for the oil to return to the oil pan from all the internal engine parts and engine block locations. Wait 15 minutes to check the engine oil if the engine has been run at normal temperatures. Wait 1 hour if engine has been idling.

If engine oil must be added do the following:

1. Locate the correct engine oil type and viscosity.
2. Remove the oil fill cap.
3. Pour the oil slowly into the fill hole. Wait 5 minutes for the engine oil to reach the oil pan bottom.
4. Check the oil level again. If needed repeat the process. Remember to proceed with small quantities of oil to prevent overfilling the crankcase.
5. Always wipe the dip stick with a clean, lint-free cloth before rechecking the oil level each time.

Drive Oil Check

Be sure to check the drive oil on a periodic basis and when changing oil note that drive types determine drive oil capacity amounts so check the chart in the Volvo operator's manual (Technical Data).

To check the stern drive oil do the following:

1. Remove the cover (1) on the top aft stern drive section. Store hardware for reassembly.
2. Trim the stern drive until the oil filler hole plug sits horizontally.
3. Remove the oil filler hole plug (2).
4. Check to verify that the stern drive oil is 1.6" below the edge of the oil filler hole.
5. If stern drive oil is low, fill to the level shown at top illustration. Do not overfill as the oil needs expansion room and overfilling causes foaming. Check technical data for recommended oil type.
6. After filling with oil reinstall the oil filler plug. Make sure it is tight. Reinstall the cover plate. Tighten all hardware.

NOTICE

TO PREVENT POSSIBLE INTERNAL OUT DRIVE DAMAGE IF WATER (MILKY LOOK) IN THE OIL, DO NOT RUN UNIT. CALL YOUR CLOSEST AUTHORIZED REGAL/ VOLVO DEALER.

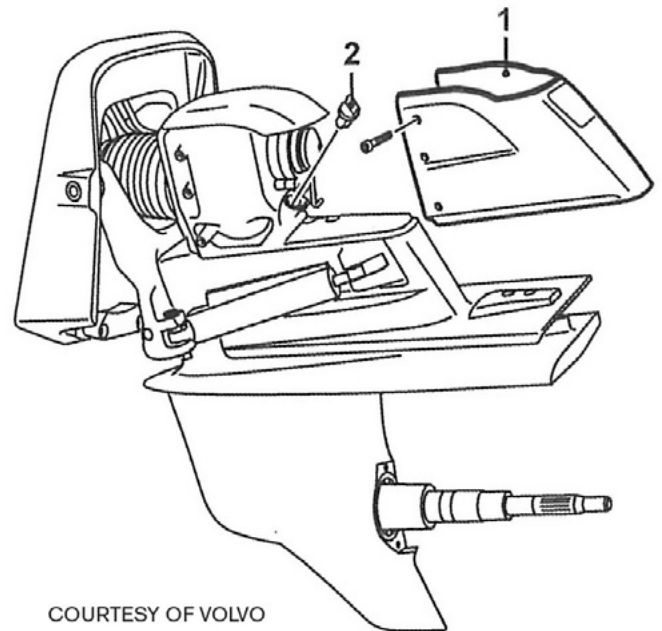
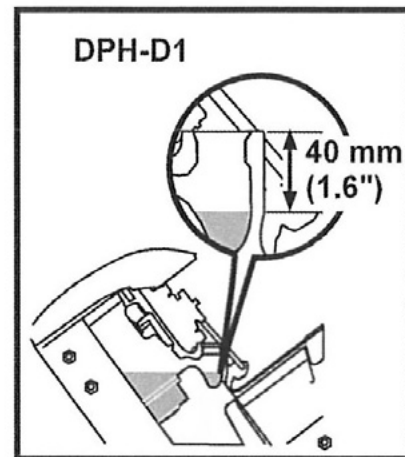

Freshwater Engine System

Periodically check the following engine and refer to the Volvo engine operator's manual for recommendations, requirements, and specifications. Contact your authorized Regal or Volvo repair facility for further assistance with the following systems mentioned.

There is a closed cooling system called the freshwater system which uses products based on Organic Acid Technology (OAT) through an expansion tank. These Volvo products ensure the freshwater side of the cooling system is protected from corrosion, cavitation, and freezing climates. This ultimately assures maximum engine life.

Fill the expansion tank to within the minimum and maximum levels. Use the proper Volvo coolant (never water). Remove the filler cap slowly when the engine is cool. Wrap a turkish towel around the cap to help prevent steam or hot coolant escaping quickly. Read and understand the following label.

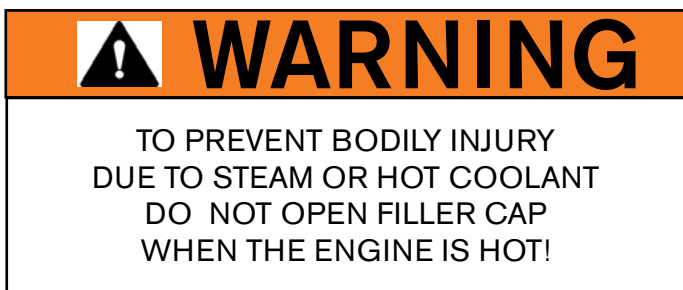

Seawater Engine System

There is a seawater system that uses raw water to cool the engine externally. Water via the engine mounted raw water pump ingests seawater through the drive up via a seacock to the raw water pump and through an impeller expels water through the engine and eventually exits through the exhaust elbow where it is mixed with exhaust gases.

Periodically the raw water impeller must be checked for cracking or damage. Make sure keys are out of the ignition and the appropriate engine battery positive post is disconnected. If installed, turn off any system seacocks.

Periodically the seawater filter needs to be checked for debris and cleaned before reinstalling. This strainer is accessible through removing a clamp and cover at the engine top. Always recheck for water leaks after cleaning and refitting the seawater filter.

There is a red (push button to reset) circuit breaker on the engine to protect the engine circuit wiring. Should it open the engine will not start until it is reset. Always find the root cause of the problem before resetting the breaker and starting the engine.

Helm Systems/Diesel Stern Drive (Typical)

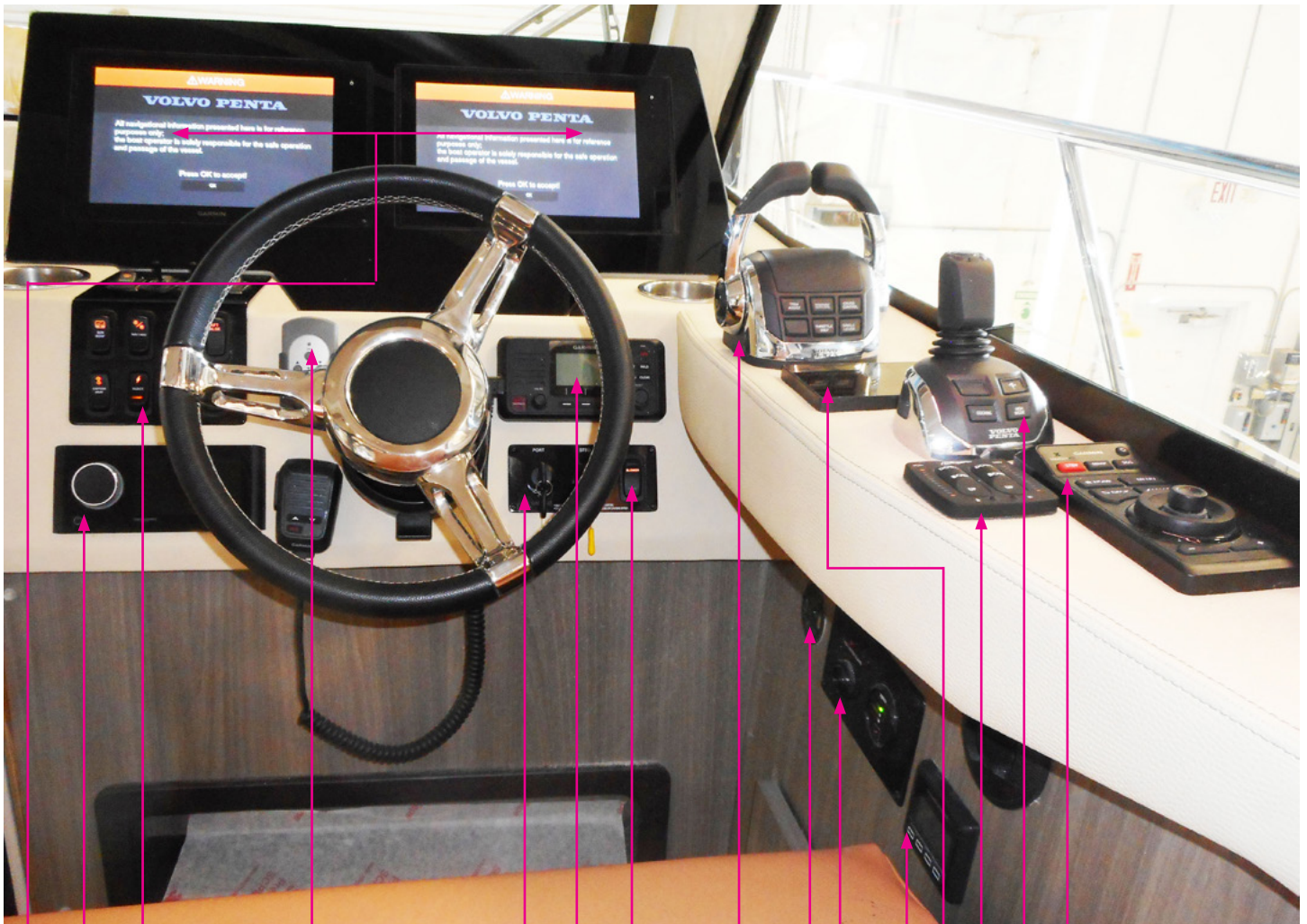

WINDLASS REMOTE

IGNITION PANEL

VHF MARINE RADIO

SWITCH PANEL

BLOWER SWITCH

REMOTE CONTROL

AUTOMATIC FIRE EXTINGUISHER
SYSTEM ALARM/GAUGE

GARMIN GRID

HIGH WATER ALARM

JOYSTICK

FUSION APOLLO

TRIM TAB PANEL

CHART PLOTTERS

START-STOP & BATTERY MANAGEMENT DISPLAY- EARLIER

SEAKEEPER CONTROL

Note that select items above may be optional and may not be installed on your vessel.

Starting Diesel Engine- Earlier System

On vessels with the earlier BCM battery and system components use the following starting procedure. For further information consult the Volvo diesel operator's manual.

Starting engines using E-key/Panel

1. Unlock the EVC system using the E-key panel.
2. Ensure remote control is in the Neutral position.
3. On the ignition panel depress the port ignition button. The green light will indicate ignition.
4. On the ignition panel depress the starboard ignition button. The green light will indicate ignition.
5. To start the port engine depress the start/stop button once. Release the button when the engine starts.
6. To start the starboard engine depress the start/stop button once. Release the button when the engine starts.
7. Allow engines to warm to normal operating temperatures while checking for engine faults.

Starting engines using Start/Stop display panel

1. Ensure the display panel is energized.
2. Ensure the remote control is in the Neutral position.
2. Press the Start/Stop panel button for each engine.
3. Release the button as soon as the engine has started.
4. Allow engines to warm up to normal operating temperatures while checking for engine faults.



WARNING

TO PREVENT ENGINE DAMAGE AND DECREASED ENGINE LIFE NEVER RACE AN ENGINE WHEN COLD.



WARNING

TO PREVENT A POSSIBLE EXPLOSION AND/OR ENGINE DAMAGE NEVER USE STARTING FLUID TO START A DIESEL ENGINE!



WARNING

TO PREVENT ENGINE DAMAGE AND
DECREASED ENGINE LIFE
NEVER RACE AN ENGINE WHEN COLD.



WARNING

TO PREVENT A POSSIBLE EXPLOSION AND/
OR ENGINE DAMAGE NEVER USE STARTING
FLUID TO START A DIESEL ENGINE!

Diesel Engine Troubleshooting Aids

The list below shows selected possible causes of engine malfunctions and is numbered to aid in Volvo diesel engine troubleshooting procedures. Obviously this list does not cover every possible engine symptom or related cause. For additional assistance consult your diesel engine operator's manual or contact your closest Regal dealer as they have factory training and the needed tools for more complex engine repair and diagnostics.

Engine Symptoms and Possible Related Causes

Engine starter motor spins slowly or not at all	1, 2, 3, 24
Engine will not start	3, 4, 5, 6, 7, 24
Engine starts but will not stay running	6, 7, 24
Engine hard to start	4, 5, 6, 7
Engine not reaching correct rpm at full throttle	5, 6, 7, 8, 9, 10, 11, 15, 18, 19, 20 21, 24
Engine has knocking sound	4, 5, 6, 7
Engine not running smoothly	4, 5, 6, 7, 10, 11, 15, 18, 19, 20, 21, 24
Engine has a vibration	15, 16
Engine has high diesel fuel consumption	8, 9, 10, 12, 15, 21
Engine exhaust is black	10
Engine exhaust is blue or white	12, 21, 22
Engine exhibits low oil pressure	13, 14
Engine exhibits too high of a coolant temperature	17, 18, 19, 20, 21
Engine charging system exhibits no or low charge	2, 23
1. Low or dead engine starting battery	13. Insufficient engine oil level
2. Battery cables corroded or loose	14. Oil filter obstructed/sender faulty
3. Faulty relay or fuse/breaker tripped	15. Propeller damaged or wrong one
4. Insufficient fuel supply	16. Engine mounts loose or broken
5. Clogged fuel filter	17. Insufficient engine coolant
6. Water or debris in fuel filter	18. Obstructed seawater intake, line, or filter
7. Fuel system lines leaking	19. Circulation pump belt slipping
8. Boat overloaded or water in bilge	20. Faulty water pump impeller
9. Propeller corroded	21. Faulty engine thermostat
10. Insufficient air for engine to breathe properly	22. Engine oil level excessively high
11. Too high a coolant temperature	23. Alternator belt slipping/loose
12. Too low a coolant temperature	24. Stored diagnostic fault codes/read by service tech only

Chapter 6

Vessel Operation

Getting Underway

Pre-departure Questionnaire

- Have all fluid levels been topped off?
- Is the fuel tank full?
- Is all safety equipment accounted for and easily accessible?
- Are navigation lights and horn operating properly?
- Is the bilge free of water and does the bilge pump operate?
- Is the engine and propeller in good working condition?
- Is the drain plug in place ?
- Have all passengers been briefed on emergency procedures and seated for departure? Is the boat load balanced?
- Is the operator sober, alert and ready to skipper the vessel?
- Have all passengers been fitted for life jackets?
- Has a float plan been filed and left with a component person?

- Has the bilge been sniffed and the fuel system leak checked?
- Are sea cocks open (if applicable)?
- Is all communication equipment in good operating condition?
- Has a second person been briefed on operational procedures should the skipper become disabled?
- Are all displays and electrical switches functioning properly?
- Has weather information been gathered and analyzed?

Underway Questionnaire

- After casting off have all dock lines and fenders been stowed?
- Are all passengers seated and all doors closed and latched?
- As skipper are you monitoring the dash gauges and/or Garmin plotter for changes?
- As skipper are you on the lookout for changing weather?
- Is the remote control safety lanyard tightly secured to your belt or clothing?

Disembarking Questionnaire

Have you removed the keys from the ignition and secured them?

- Have all systems been checked for leaks?
- Has the battery switch been turned to the “off” position?
- Are all sea cocks closed (if applicable)?
- Has the fuel tank been filled enough to prevent condensation?
- Is the vessel properly tied and covered with equipment stored?

Fueling

 **DANGER**

AVOID SERIOUS INJURY OR DEATH!
GASOLINE IS HIGHLY FLAMMABLE
AND EXPLOSIVE MATERIAL.
PRACTICE “NO SMOKING” AND EXTINGUISH
ALL FLAMMABLE MATERIALS
WITHIN 75 FEET
OF THE FUEL DOCK

 **WARNING**

AVOID INJURY OR DEATH FROM FIRE
OR EXPLOSION
RESULTING FROM LEAKING FUEL!
INSPECT ENTIRE FUEL SYSTEM AT
LEAST ONCE PER YEAR.



WARNING

SINCE GASOLINE IS AVAILABLE
IN SEVERAL GRADES
INCLUDING ETHANOL AND VARIOUS OCTANE
LEVELS, REFER TO THE OUTBOARD ENGINE
MANUFACTURER'S OWNER'S MANUAL FOR THE
CORRECT GAS TYPE/GRADE.
USING THE IMPROPER OCTANE LEVEL
OR THE WRONG GASOLINE TYPE CAN CAUSE
ENGINE DAMAGE AND VOID THE WARRANTY!

Before Fueling

- Make sure a working fire extinguisher is available.
- Stop engines and any device that can cause a spark.
- Disembark all passengers and crew not needed for fueling.
- Fuel if possible during the daylight hours.
- Check to ensure nobody is smoking in the boat or near the fueling dock.
- Close all portholes, hatches and doors to keep vapors from blowing aboard and settling in the bilge.
- Tie up your boat securely at the fuel dock.
- Identify the fuel fill. Unfortunately, people have mistakenly filled the water or waste with fuel.
- Visually inspect all fuel system components before each filling.
- Avoid using fuels with E-15 alcohol additives. It can attack fuel system parts along with hoses and cause deterioration.

During Fueling

- Keep the fuel nozzle in contact with the fuel fill to guard against static sparks. The fuel fill pipe is grounded through the fuel system wiring to protect against static electricity.
- Avoid overfilling the fuel tank. Leave room for expansion. Also, if fuel exits the fuel vent indicating the tank is full, this situation is dangerous and unfriendly to the environment.
- Avoid spilling any fuel. Clean up any fuel accidentally spilled with a clean rag and dispose of it on shore.

After Fueling

- Close all fuel fill openings tightly. Use a fuel key if needed.
- Open all portholes, hatches and doors if applicable.
- Sniff in the bilge and engine area for gas fumes. If fumes are detected continue to let the area ventilate until the odor is gone. Look for any traces of fuel droplets or spillage. Do not start the engine(s), smoke or run any electrical components until the fumes can no longer be detected.

Dock Line Basics

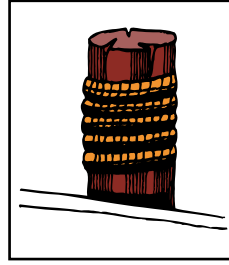

Most skippers use dock line terminology fairly loose but there is more to the basics than just bow or stern lines. There are several lines that can be secured to the bow and stern and depending on their direction and use, can be called other names. Remember that “forward” and “aft” refer to the direction that a spring line runs from the vessel, and not where it is secured on board.

Bow/Stern Lines

There is only one true bow line. It is secured to the forward cleat and runs forward along the dock to prevent the vessel from moving to the stern. The stern line leads from a rear cleat to a piling or cleat on the dock astern of the vessel. This line keeps the boat from moving ahead. For small vessels these are the only lines needed for normal wind and current conditions. If located in a tidal environment, keep slack in the lines.

Breast Lines

These lines are attached to the bow and stern that lead to nearly right angles from the center of the vessel to the dock. They help keep larger vessels from moving away from the dock, or are pulled in to help people board the vessel. Larger vessels may use bow or quarter breast lines.

Spring Lines

Most small boats use two spring lines although it is possible to have four. They are called the after bow spring and forward quarter spring.

Bow springs are secured at the vessels bow area.

Forward spring lines lead forward from the boat to the dock and control movement toward the stern. After springs stem aft from the vessel, and stop movement ahead. Spring lines are used to prevent movement in a berth, ahead or astern. They are really useful in controlling the effects of a real active tidal surge. Spring lines are useful where fenders need to be kept in place against piles.

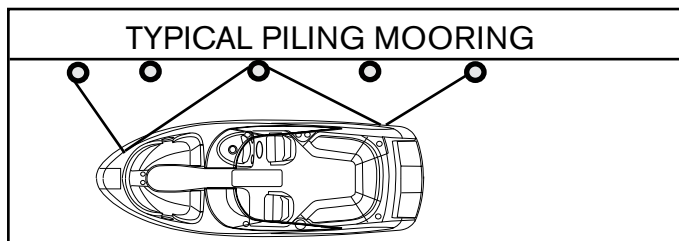
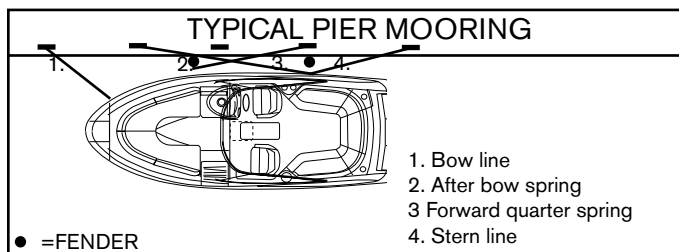

Boat Docking/Moorings

Most boats can be secured to a dock using four lines. The after bow spring is crossed with the forward quarter spring and secured to individual dock cleats or pilings. This ensures longer springs and can be snugged up tighter for more efficient tidal control.

Remember, if you only have one piling available, position the vessel so this point is opposite amidships. Run both spring lines to it. These lines will be shorter but still useful. The bow and stern lines should be relatively at a 45 degree angle with the dock. The stern line can be attached to the near-shore quarter cleat, but will work more efficiently to the offshore quarter cleat. The longer line will allow the boat flow with the tide with less time checking the vessel.

Dock Line Sizing

Most dock lines today are made of nylon, either of twisted rope or braided core and cover. The most often used material is nylon because of its stretching abilities absorbing shock loads. It is chafe resistant for extended life and is easier on bare hands.

The line's size varies with the vessel. Normally, a vessel in the 20' to 40' boats will use 1/2" diameter nylon lines. Larger yachts use 5/8" and 3/4" diameter nylon lines. Smaller boats can use 3/8" nylon lines.

Dock lines need to have the strength to hold the vessel and have enough density to resist chafing. They shouldn't be too heavy that they lose their shock-absorbing capabilities. Use the right size line for the vessel since a line too large for the boat will pull hard against the vessel since it won't be forced to stretch. If the line is too small for the vessel, there is no margin for wear and chafe when under strain.

Securing Dock Lines

When mooring your boat, make sure the dock lines are secured at both ends. Depending on your situation you may need to loop the eye splice of the dock line around a piling.

Sometimes the mooring line will lead down sharply from the piling to the deck cleat. Loop the eye splice around the piling twice to keep it from being pulled up off the pile.

Pull the line through the looped eye if the mooring line is too small to go around the piling twice or too small to fit over once.

If you must drop a line over a piling that already holds another boat's line, run the eye of the line up through the first eye from below, then loop it over the pile. This will allow either line to be removed without disturbing the other. If another line is dropped over yours, simply reverse the process. Secure a little slack in the other dock line, then slip your eye up through its loop and over the top of the pile. Your line can be dropped through the other eye.

When debarking from a dock, it is easier to release the line from a cleat or piling, from on board the boat, as soon as you leave the dock. Loop a long line around the cleat or pier and leading both ends on board you can release the line easily. Slip one end around the cleat or pile, then pull it back on board. Release the line without the eye splice, so it will run freely from around the pile without hanging up on the splice.

Fenders

Fenders are normally made of a rubberized plastic and are usually filled with air. Most have a fitting like a basketball so they can be inflated or deflated. Fenders are available in a wide range of sizes and shapes to fit both small and large vessels. Fenders are normally designated in inches. They are used between piers, docks, sea walls and the boat.

They protect the top sides of the boat from rubbing against rough objects. Most fenders have eyes of attachment which allow a line to be inserted vertically or horizontally. This will permit the fender to be tied off to fit a variety of marina, dock and tidal situations. Be sure the fender is correct for the vessel size. It is a good idea to carry extra fenders but half a dozen is normally an acceptable number. Remember to store fenders on board so they can be easily accessed. Some people incorrectly call fenders "bumpers".

Note that optional fender clips are available for your vessel.



There is a variety of fender styles and types, each selected for specified uses. When choosing fenders, contact a marine dealer or supply house. Explain how you moor and use your vessel so they can recommend the best fender type for you. We suggest the type with a fill plug so you can inflate them with a hand pump like the ones used for bicycles.

Maneuvering

Directing propeller energy (thrust) makes slower speed maneuvering easier. The propeller discharge current is turned from one side to the other which results in turning forces. Rudder boats need water to flow by the rudder to be efficient. Out drive units are designed to have reduced shaft angle, so the propeller does not produce as much unequal blade thrust and resistance. Large horsepower boats do produce more thrust and steering torque but your vessel has the advantage of assisted power steering.

Below is some basic information on how boats handle in normal conditions.

Gathering Headway



When a vessel is not moving forward or reverse in the water and the propeller is not turning, (shift in neutral) the boat will not react to the helm steering wheel.

As soon as the vessel is shifted into forward gear propeller action creates a discharge motion and generates energy in the form of thrust. If the outboard drive is centered, the discharge motion is directed straight back causing the vessel to advance forward.

You may notice that if you advance the throttle quickly in initial take-off (make sure you have a firm grip on the wheel), the boat has a tendency to pull the stern of the vessel to starboard. There is a trim tab (also serves as a sacrificial anode) located on the out drive housing. This trim tab helps compensate for the low speed steering torque. Once the boat increases headway and the propeller is operating in a faster water flow this torque effect decreases.

Sometimes the trim tab may need adjustment. Contact your Regal dealer for further information or consult your engine manufacturer's manual.

Turning

Once the boat has gathered headway, with the boat planing at the correct bow angle and the outboard drive unit and helm straight the boat tends to stay on a uniform course heading. To assure the boat trim angle is correct use the chart plotter screen trim gauge as a guide while activating the trim button on the remote control panel.

When the helm wheel is turned to the right or starboard, the drive unit is turned in the same direction. The propeller's discharge force is directed to starboard forcing the boats stern to port. Water flowing past the hull strikes the stern drive gear housing in its starboard side, creating additional turning torque. The stern starts a move to port, forcing the bow to starboard.

If the helm is turned to the left or port the drive turns to port, the stern of the boat goes starboard as the bow turns to port.

As the vessel operator gains experience, he will better gauge each maneuver and speed situation. In this way he will understand the handling characteristics of his boat. He needs to keep the safety of his passengers in the highest priority.

Backing Down

If your boat has the steering wheel and outboard drive straight with the control in reverse, the stern will be pushed a bit to port by the reversing propeller thrust. This tendency to back to port can be eliminated by turning the outboard drive to starboard.

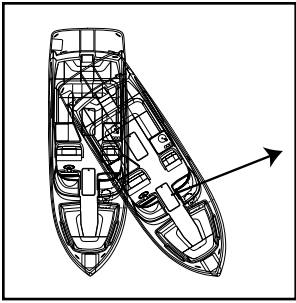

When the vessel begins to gather speed to stern, the water passing by the lower gear case housing will continue to increase steering torque. If the helm wheel is turned to

starboard, and will direct the propeller thrust to port, tracking the stern to starboard.

Wind and current will affect how a vessel backs. Outboard drive boats tend to be light displacements and when backing down in a strong crosswind, the bow will tend to fall toward the windward. This may cause steering problems.

Stopping

Remember that your boat does not have any brakes. It uses reverse thrust from the propellers to stop. If the vessel has headway, with the helm and propeller in reverse the propeller thrust is directed backwards, past the lower gear case. Depending on how far the throttle is advanced, the discharged thrust may not be strong enough to reverse the water flowing by the gear case. As the power is increased, the propeller thrust becomes strong enough to stop the flow of water past the lower unit, and, as the throttle is advanced it reverses its flow more completely.

When water is flowing past the gear case, steering torque is increased, but when the thrust stops the water flow, the boat will not respond to the helm. This is a short lived event and is overcome quickly when the water again flows past the gear case. Furthermore, added to the energy of the water hitting the lower gear case, the propeller thrust is directed by turning the outboard drive unit which can add to the steering torque.

The prop tends to throw the stern to port. This is why experienced skippers undertake a port side landing when wind and current conditions permit. They allow the prop to move the stern to port toward the dock. With a forward motion when the helm wheel is turned hard to one side, the vessel pivots around a point about 1/3 its length abaft to stern.

Power Trim/Trim Tabs

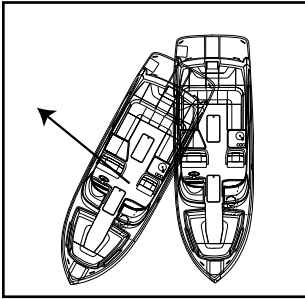

Twin propulsion boats have the ability to angle in or out their drive unit in relationship to the transom. This is accomplished by hydraulic shocks located on the lower unit housing along with an electrical

sender unit that reads the drive angle and sends information to the chart plotter showing a reading.

Purpose of Power Trim

The purpose of the power trim/tilt is to enable the operator to change the angle of the outboard drive while at the helm. Changing the angle of the drive or “trimming” provides the following benefits:

1. Improves acceleration onto a plane.
2. Maintains boat on plane at reduced throttle settings.
3. Increases fuel economy.
4. Provides smoother ride in choppy water.
5. Increases top speed.

In short, it is a way of fine-tuning the performance of your boat and will enable you to get the most efficient and comfortable ride possible, whatever the conditions.

Using Power Trim

The power trim is normally used prior to accelerating onto a plane, after reaching the desired RPM or boat speed and when there is a change in water or boating conditions. Position passengers and equipment in the boat so that the weight is balanced correctly fore and aft as well as side to side. Trimming will not compensate for an unbalanced load.

To operate the trim, push the switch until the desired bow position is reached. The trim may be operated at any boat speed or at rest. Avoid operating the trim system when running in reverse. Observe the trim/tilt gauge which indicates the boat’s bow position achieved by the trim angle of the vertical drive unit. “Bow-Up” corresponds to the upper portion of the trim range on the gauge while “Bow Down” corresponds to the lower portion of the trim range on the gauge.

To determine the proper trim angle, experiment a little until you are familiar with the changes in your boat. The vessel will be properly trimmed when the trim angle provides the best boat performance for the particular operating conditions. A trim position that provides a balanced steering load is desirable. To familiarize yourself with the power trim, make test runs at slower speeds and at various trim positions to see the effect of trimming. Note the time it takes for the boat to plane. View the chart plotter screen, tachometer and speedometer readings as well as the ride action of the boat.

Operation In “Bow Up”

The “Bow Up” or out position is normally used for cruising, running with a choppy wave condition, or running at full speed. Excessive “bow up” trim will cause propeller ventilation resulting in propeller slippage. Use caution when operating in rough water or crossing another boat’s wake. Excessive “bow up” trim may result in the boat’s bow rising rapidly, creating a hazardous condition.

Operation In “Bow Down” Position

The “Bow Down” or in position is normally used for acceleration onto a plane, operating at slow planning speeds, and running against a choppy wave condition. It is also used when pulling water skiers, tubers, knee boarders, etc. In this position the boats’ bow will want to go deeper into the water. If the boat is operated at high speed and/or against high waves, the bow of the boat will plow into the water.

Operation In “Level” Position

In normal running conditions, distribute passengers and gear so boat is level. At or below cruising speeds, trim the vessel for optimum performance. The trim gauge will show somewhere in the center of the gauge. This position will also enhance running visibility and overall stability. Again, each outing provides different wave, load and running conditions. Be prepared to make trim changes as needed.

TRIMMED “TO FAR IN” POSITION



TRIMMED “TOO FAR OUT” POSITION

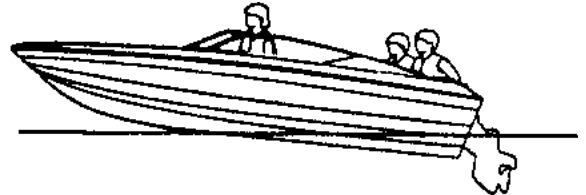

WELL TRIMMED “LEVEL” POSITION

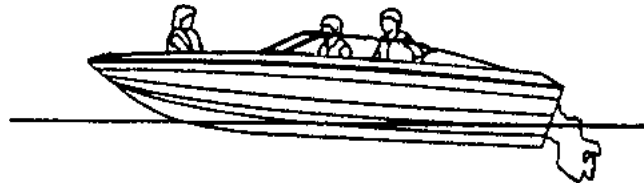

Typical Examples (Stern drive shown)



CAUTION

THE BOAT TRIM SHOULD BE ADJUSTED TO PROVIDE BALANCED STEERING AS SOON AS POSSIBLE EACH TIME YOU GET UNDERWAY. SOME BOAT/ENGINE/ PROPELLER COMBINATIONS MAY CREATE BOAT INSTABILITY AND/OR HIGH STEERING TORQUE WHEN OPERATED AT OR NEAR THE LIMITS OF THE “BOW UP” OR “BOW DOWN” POSITIONS. BOAT STABILITY AND STEERING TORQUE CAN ALSO VARY DUE TO CHANGING WATER CONDITIONS. IF YOU EXPERIENCE BOAT INSTABILITY OR HIGH STEERING TORQUE SEE YOUR AUTHORIZED REGAL DEALER.

Shallow Water Operation

Operating your vessel in shallow water presents various hazards. You are more apt to hit a submerged object such as a rock, sand bar, stump coral, or other unmarked objects.

Pay close attention to your charts for descriptions of any shallow areas along with marked submerged objects. Always post a lookout when operating in shallow water. Trim your drive up as needed to provide adequate draft. Set the alarm on your depth sounder and travel at a speed that will keep the boat level in these shallow areas.

If your boat strikes a submerged object stop immediately and check for hull, drive and propeller damage.

Anchoring

Selecting the correct anchor is an important decision. The anchor style in part depends on the usage and boat type. Regal boats designate an anchor type and or model. Some models incorporate chain, line with an optional windlass. Contact an authorized Regal dealer for more information.

Anchoring is easier with another person on board. First be certain that the line for the anchor is properly attached, to avoid losing the anchor and anchor line overboard.

For most anchors to perform more efficiently, you should attach 3 to 6 feet of chain. The chain will stand up to the abrasion of sand, rock, or mud on the bottom much better than a nylon line. It should be galvanized to reduce corrosion. Next, attach a length of nylon line to the other end of the chain.

The nylon will stretch under a heavy strain cushioning the impact of waves or wind on both the boat and the anchor.

To anchor, select a well protected area, preferably with a flat bottom. Contrary to modern belief, you do not throw the anchor over while the boat is making headway, or moving forward. In fact, the bow of the boat should be brought slowly backward, while easing the anchor slowly over the side of the boat until it hits the bottom. To “snub the line” means to stop its outward “pay” or movement. Usually the length of anchor line used should be 5 to 10 times the depth of the water.

After you have anchored, check your position with landmarks if possible. You need to continue to monitor landmarks to make sure you are not drifting.

Since anchoring can also be an emergency procedure, the anchor and line should be readily accessible.

For increased holding power in windy conditions, two anchors are sometimes set. If your primary anchor drags, you can run out your secondary anchor without picking up the primary one. The important thing is to lay them out at an angle. When setting two anchors, make sure they are fastened to separate rodes or cleats. This is done in case you need to adjust one later so the line is accessible. If two anchors are used ahead of a boat, make sure to set the rodes at an angle than in a straight line to reduce the chances of tangling as the boat moves in wind and current. See the illustration.

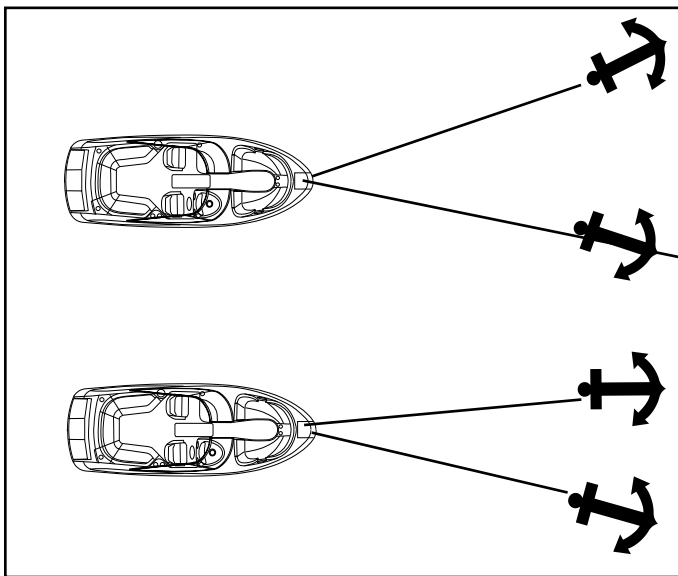

The Law Of Salvage

The Admiralty law sometimes referred to as the salvage law was founded primarily on English law fundamentals and basically says that a vessel distressed, in danger of flounder, if rendered assistance from a towing company or private agency, can be forced to relinquish a portion of the vessels' worth for the assistance received.

NOTICE

IN THE EVENT
YOUR VESSEL IS IN DISTRESS,
PRIOR TO ALLOWING ANY TOWING
COMPANY OR PRIVATE AGENCY THE
RIGHT TO PASS A LINE TO YOUR VESSEL,
BE SURE TO ESTABLISH THAT YOU
DO NOT AGREE TO SALVAGE RIGHTS.
ESTABLISH WITH THE CAPTAIN
OR OPERATOR THAT YOU WISH TO BE
ASSISTED IN A CONTRACT BASIS AND
ESTABLISH A PRICE.
OF COURSE IN CERTAIN SITUATIONS, YOU
MAY NOT HAVE THIS OPTION.

USE YOUR BEST JUDGEMENT!

Towing

In case you find yourself aground or in need of a tow, or should you want to tow another vessel, keep in mind that you never use deck hardware or cleats to secure lines for towing!

Deck hardware is intended for mooring and anchoring, and is not designed to withstand the strain and pull of towing. Rather than tie the line to your cleats on deck, it is suggested that you tie a bridle by passing a line completely around the hull of your boat to avoid damage.

When towing, always stand clear of a taut line, as any type of line breaking under stress can be extremely dangerous. The preferred line for towing is double-braided nylon, as it has sufficient elasticity to cushion shock loads. Move slowly and cautiously.



WARNING

AVOID INJURY OR DEATH!
DO NOT USE DECK HARDWARE
INCLUDING CLEATS
FOR TOWING.

Knots

Knots are useful in docking, towing and other emergency situations. Learning to tie knots requires practice. As they say “Practice makes perfect”. Some of the knots used in boating are the square, bowline, anchor bend, clove hitch, figure eight and half hitch. There are several periodicals available that explain various knots and how to tie them effectively. An experienced skipper will know the basic nautical knots and will use them when on the water. Take the time to know the basic knots.

**Figure 8 Knot
Tied To Cleat**



A useful knot to learn for general docking is the figure eight with one end reversed. By turning the free end of the line back under, the knot can be released without disturbing the boat. After some practice one person can secure a vessel easily to a dock or pier in a variety of weather conditions. This knot normally is used to tie the bow and stern. Then the vessel can further be fastened by tying the spring line in the figure eight knot. Wrap it around the cleat 2 or 3 times.

Emergencies

Always be ready to help others on the water if possible, but do not take any unnecessary risks. Use equipment to save a life, but do not risk a life to save equipment. Consult earlier information in this manual concerning accidents, etc. Also, read other literature concerning on the water emergencies. Be alert and prepared!

Fires

Fire aboard a vessel can spread quickly and can cause tremendous alarm among everyone. Most fires can be prevented by keeping the bilge free from oil and debris. Keep all equipment stowed and maintained in working order. Carry a backup fire extinguisher on board. If something becomes a possible fire hazard, remove that possibility at once. Never use water on gasoline, oil or electrical fires. When you dump water on an electrical fire you can be shocked since water conducts electricity.

Follow these instructions if a fire breaks out:

- A. Fit everyone aboard with a life jacket. Turn off the ignition.
- B. Try to keep the fire downwind. If the fire is to the stern, head the bow toward the wind. If forward, put the stern to the wind.
- C. If the engine should catch fire, shut off the fuel supply. Usually there is a fuel tank access that you can crimp the fuel feed line.

D. Use a hand fire extinguisher. Make sure to point it at the base of the flames. Use short bursts and sweep the extinguisher side to side.

Remember : (4 lb. extinguisher discharges in 20 seconds)

These actions help prevent the fire from spreading to other parts of the boat. You can extinguish fires quickly if you act swiftly. Have a plan of action in motion in case a fire breaks out.

First Aid

Knowing first aid can save lives. A first aid kit and the ability to use it are important ingredients for the safety of a skippers' passengers, crew and vessel. Having confidence and competence in handling medical emergencies on board is a must for the skipper. Invest your time in a first aid course available at the American Red Cross.

CPR (Basic Life Support)

If someone is seriously injured have someone call for help while the injured person is being attended.

Check for possible danger signs; loss of breathing, unconsciousness, severe bleeding and heartbeat. If you determine the individual is not breathing or unconscious place the victim on their back on a hard surface and do the following:

1. If unconscious, open the airway. Neck lift, head lift or chin head lift.

2. If not breathing, begin artificial breathing. Pinch the nose. Give 4 quick breaths. If airway is blocked, try back blows, abdominal or chest thrusts and finger probe until airway is open.

3. Check for pulse. Begin artificial circulation. Depress sternum 2".

15 compressions rate 80 per minute. 2 quick breaths. Continue uninterrupted until advanced medical support is available.

Follow up immediately with medical authorities!

Hypothermia

Hypothermia is a condition where the body temperature decreases because the body can't generate enough heat to maintain its normal temperature.

It can be serious and usually occurs where victims have been immersed in water (under 68 degrees) for extended periods of time. If you encounter a possible hypothermia victim call for help on the radio and get the person out of the water.

Symptoms are:

1. Shivering that if condition is advanced may stop.
2. Confusion, clumsiness or slurred speech.
3. Rigid muscles.
4. Semiconscious to unconscious.

Treat hypothermia by the following:

- Remove wet clothing.
- Monitor the victim's pulse and breathing.
- Rapidly apply heat to the body core by using blankets, naked bodies or warm water.
- Do not give the person any food or drink.
- Do not warm the arms and legs. Warming of these extremities can be fatal.

Follow up immediately with medical authorities!

Environmental Awareness

There are numerous vessels operating on our waterways on a daily basis. Each boat has an impact on our environment. Boat operation habits, marine sanitation, and maintenance all play a role in a delicate battle to keep the ecosystem clean. Each of us has a role in doing our part as an environmentally conscious skipper to conserve our waterways.

The National Marine Manufacturer's Association lists their top ten of Eco-Boating Practices as follows:

1. Observe all regulatory agency policies regarding marine toilets.
2. If equipped with a holding tank, use marina pump-out facilities.
3. If used, make sure bottom paints are legal and ecosystem friendly.
4. Use only biodegradable cleaning agents.
5. Dispose of all garbage and litter on shore properly, not on the water.
6. Don't top off fuel tanks. Leave expansion room. Clean up spills.
7. Watch your wake and propeller wash.
8. Make sure your engines are well tuned and maintained.
9. Control your bilge water.
10. Practice the "catch and release" principle.

Follow these basics practices when on the waterways. Treat the environment in a way that you would like to be treated.

Chapter 7

Auxiliary Equipment Operation

Overview

This chapter will assist the boat operator in understanding selected standard and optional equipment components on the vessel. *Select equipment described may not be installed on your boat or the pictorials may not exactly resemble components on your craft. Remember, Regal is constantly improving its product line and will make changes in vendors, parts, and specifications without notice.*

***On all chain units a chain stopper is used to remove the load on the windlass. (Not shown)**

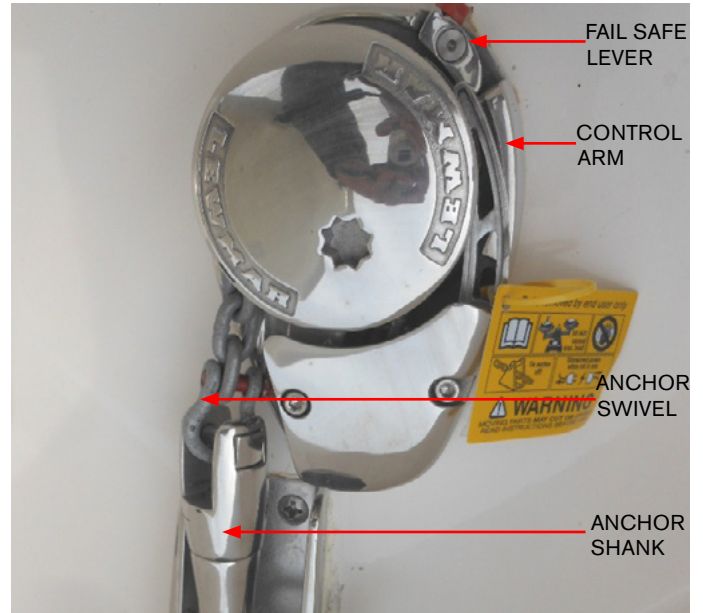

Anchor Windlass

If installed the anchor windlass features a stainless steel polished “claw” style anchor complete with swivel. This anchor has high holding power in most seabeds.

Foot petals or a remote control the lowering and retrieving of the anchor through the windlass .

A 90 amp breaker for windlass over current protection is located at the DC distribution panel. There is a lanyard with a snap hook to add holding power when the anchor is in the stored position. On rope/chain combo units the cleat is for tying off the anchor rode rather than maintaining constant pressure on the windlass itself.

Note: Never use the windlass to break the anchor free from the bottom. This may cause excessive strain on the windlass motor and or hardware.

Paying Out Anchor Using Gravity

To let out the anchor release any anchor locks, insert the clutch handle into the gypsy drive cap and turn it in a clockwise direction to tighten the clutch. When in a safe mode, pull back on the clutch until the anchor and rode begin to pay out. Control the rate of anchor descent by pushing the clutch lever forward. When the desired rode is paid out, tighten the gypsy drive cap.

Paying Out Anchor Using Power

Make sure any anchor locks are disengaged such as the lanyard hook. Stand clear of all windlass components when paying out. Activate the deck locker cut-out switch to energize the dash switch, foot pedals or optional remote to pay anchor out.



WARNING

AVOID SERIOUS INJURY!
ENSURE THAT ALL BODY PARTS & CLOTHING
ARE KEPT CLEAR OF THE ANCHOR RODE
AND WINDLASS DURING OPERATION.

Using Anchor Windlass

The windlass may be outfitted with a rode using 100' of 1/2" nylon rope along with 10' of galvanized chain or all chain. The chain is connected to the anchor shank which is next to the anchor. The chain acts as a safety margin to protect the rope rode from being damaged by sharp seabed objects such as coral that might sever the rope if it was next to the anchor. If needed for harsh sea bottoms the rode can be converted over to 100' of 6 mm galvanized chain.

The safety clutch is used to "pay out the windlass chain or to retrieve the anchor "rode". There is a handle in the anchor locker that inserts into the gypsy drive cap located on top of the windlass framework.

With the handle inserted in the cap, turn the handle *clockwise* which grips the "gipsy",



OPT. REMOTE CONTROL

When the proper ratio of anchor rode is paid out disengage the dash switch or foot pedal and tie off the rode to a cleat since it is not recommended to let the windlass mechanism be the only source holding the rode to the anchor on the sea bottom (Chain stop accomplishes this on all chain units). Also, do not use the fail safe pawl to hold the anchor load as windlass damage could occur.

Hauling In Anchor-Manual Recovery

Insert clutch handle into the gipsy drive cap and turn clockwise until anchor is fully returned to the bow roller.

Hauling In Anchor-Using Power

When anchor rode is safe to retrieve activate the windlass cut-out switch in the starboard deck locker. Next, use the windlass dash switch or deck foot pedal to haul in the anchor rode.

The fail safe pawl does not need to be disengaged during retrieval as it will act as a ratchet. When the anchor has been retrieved in the bow roller position the fail safe pawl should be left engaged in the gipsy to prevent accidental activation of the windlass while underway. Note that the fail safe pawl does not need to be disengaged from the gipsy before the anchor can be paid out again.

It is recommended that during the paying out process the engines be run to stern before full scope is reached. This will help prevent the rode from being tangled in the anchor on the sea bottom. It is recommended that during the retrieval process use the engine to gather headway.

Do not let the vessel sit directly on top or over the area where the anchor lies because the chain rode could damage the hull topside.

As the anchor raises toward the scuff plate area, retrieve the last few feet very carefully to eliminate any hull damage.

Once the anchor is retrieved, check to ensure the fail safe pawl is engaged in the gipsy which will help prevent accidental activation.

 **WARNING**

AVOID SERIOUS INJURY!
DO NOT "PAY OUT" ANCHOR UNTIL IT IS
DETERMINED THAT THERE ARE NO
SWIMMERS OR DIVERS NEAR THE AREA.

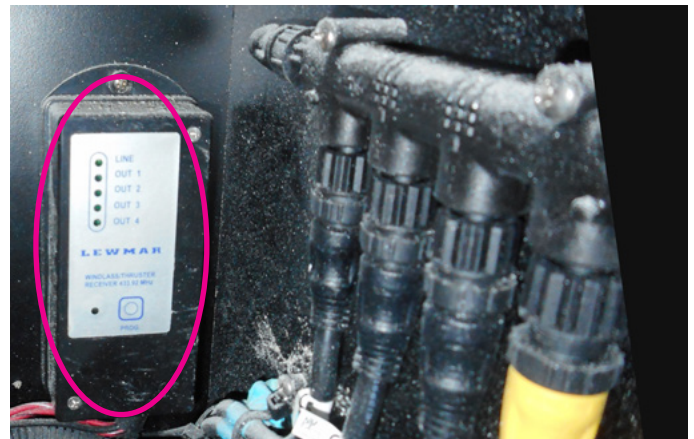

The windlass remote receiver shown above left is located at the bow end of the helm seat hull side locker. This device communicates with the windlass remote control.

There is a switch that controls the up and down windlass operation as directed by operating the up and down deck foot pedals and/or the windlass remote if installed. It is known as a dual direction solenoid switch. Periodically check the switch for tight connections. If the windlass does not move up or down it may be a defective solenoid switch or wiring defects in the circuit. See the photo below.



WINDLASS DUAL DIRECTION SOLENOID SWITCH

Windlass Safety Tips

1. Read and understand the windlass owner's manual found in the owner's information packet.
2. Keep all body parts and clothing away from an activated windlass.
3. Do not exceed the maximum load designated by specifications.
4. Always tie off the anchor rode to the designated cleat.
5. Do not use the windlass to pull or tow another vessel.
6. Always shut off windlass breaker or main battery switch before servicing the component.
7. Always use engine power to gain headway before retrieving anchor.
8. Always look for swimmers or divers before deploying anchor.
9. Always secure rode/anchor while cruising or pulling vessel on highway.

Bilge Pump

Before each outing, check the operation of the bilge pump, automatic switch, and manual switch. The bilge pump should automatically activate when water reaches a pre-determined height in the engine compartment. Test the bilge pump manually at the dashboard with the switch. Periodically check for bilge debris around the grates of both the bilge pump and automatic switch, and also bilge pump impeller.

The automatic mode for your bilge pump works similarly to the manual method. Both methods control the bilge pump by a switch, but the automatic mode utilizes a float switch. Float switches have a float that sits at water level, and when the float reaches a certain height, it trips the switch and activates the bilge pump.

Periodically you may need to disassemble the bilge pump from the grate in order to clean or access the inner mechanisms. To remove the bilge pump, utilize the quick disconnect tabs on either side of the bilge pump, squeezing them like a backpack clip while pulling up on the pump.

For switch control location, refer to the engine and controls chapter. For bilge drainage system and electrical system information, refer to the systems chapter. Refer to the vessel operations chapter for pre-departure use.

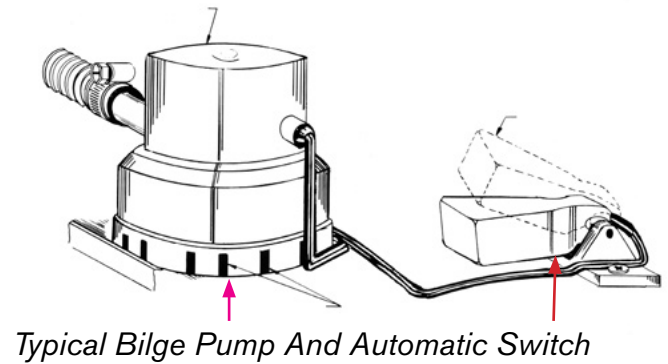

Typical Bilge Pump And Automatic Switch

Bow Thruster- Typical

General Safety Notices:



1. Be sure to read and understand the safety instructions and all thruster operation information before attempting to use the thruster system. Refer to the thruster manufacturer's

owner's manual for more detailed information.

2. Do not operate the bow thruster system close to swimmers as a high powered suction is produced at the propellers.

3. Make sure the propeller lock nut is torqued to the required foot pound specification.

Thruster Usage

To use the thruster first make sure the component is activated. If necessary there is a on/off battery switch in the bilge that is in-line with the thruster power cable feed. Make sure the switch is energized.

NOTE that there is a joystick on the helm. The thruster will assist in slow speed maneuvering especially around a dock or close mooring situations. It operates similar to a gaming or marine propulsion type joystick. To activate the joystick, push and hold the black button. The red icon will illuminate.

Never run the thruster dry; it will weld the relay contacts as it becomes a generator in spool down.

Do not make quick changes from one direction to the other direction, or it will damage the unit. The minimum running voltage for the thruster is 10.5 volts; therefore the outboard engine(s) should be running to maintain this voltage requirement.



There is an in-line ANL type fast activation fuse for over current protection behind the thruster switch panel.

Note that the main thruster breaker is attached to the port BCM (earlier system) ;the block style fuse is rated at 250 amps, is controlled by the house battery and located in the bilge compartment.

Patio Doors



The patio entrance doors are a double slider type design with heavy mechanical joints for added strength. The aluminum frame is typically finished in a weather resistant polyester powder coating. The tinted door surface is a high impact tempered glass.



Note that when underway always ensure the companionway door is closed and latched. When moored ensure that if the door is left open that the latch is flipped across the track to prevent the door from closing.

Latch the door by moving the latch under the strike plate to the up position.

Read and understand the care instructions in the care and maintenance chapter.

Patio Window



PATIO WINDOW- OPEN POSITION

The port aft half window features the ability to open and close. Using the up and down arrows at the galley wall control panel (shown as red circle) press the down arrow to open the window and the up arrow to close the window shut.

There is an electrical box mounted at patio grill wall that controls the window movements including speed.

Canvas- Transom Seats

As an option covers are available for the transom seats. The covers provide protection from the elements and are easy to install. See the care chapter for cleaning information on vinyl or Sunbrella canvas types.



Typical

Canvas- Palm Beach Cover

As an option this cover protects the entire cockpit from the elements. Light weight and easy to install to the hardtop and adjunction fasteners as you progress down to the cockpit decking.



Windshield Privacy Cover

As an option this cover provides protection from the bright sun's rays along with staring eyes.



Cockpit Grill (Typical)



There is a safety shut-down switch located at the grill top. With the top in place there is no power to the grill controller and can not be turned on until the top is removed.

Behind the grill cabinet is a limit switch junction box. The device will shut the grill down if it overheats.

Be sure to read the grill manual to become acquainted with all the safety features and proper modes of operation before attempting to use the grill. To use the cockpit electric grill you must activate the dedicated breaker on the ship's main panel.



Of course you must either be on dock side power or have the generator running as the grill operates at 120 volts.

Next, locate the grill controller on the face of the cabinet. Push the center button to activate the grill.

Change the grilling temperature by using the plus or the minus buttons on the grill control. Read the grill owner's manual for further information.

Always have a fire extinguisher handy. Should there be an emergency situation close the cover. Power to the grill will be shut down at this point. After grilling be sure to let the element cool before closing the cover.



Cockpit Grill- Safety Instructions

1. The unit is designed to cook food like meat, fish or vegetables. Do not use it for any other purpose since it could be dangerous.
2. Do not operate the grill in rough seas or high winds.
3. Do not add burning type charcoal briquettes or volcanic stones to the unit.
4. Never operate the grill while making headway (under engine power).
5. Never grill with any canvas in the up position since smoke and odors from cooking could infiltrate the canvas fabric over time.
6. Keep combustible materials away from the grill.
7. Keep children away from a hot grill surface.
8. Let the unit cool down before attempting to cover it.
9. Keep the grill covered when not being used.

Cockpit/Patio Refrigerator (Typical)

If installed, the cockpit refrigerator provides chilled and frozen storage areas for food and beverage . It features a brushed 316 grade stainless finish steel door and LED lighting and easy to use thermostat.



Includes a freezer drawer. The unit operates at 12 volts DC voltage and draws approximately 6 amps along with requiring a minimum of 10.9 volts.

Using Thermostat Control

Note the thermostat (temperature control) in the above illustration. This device sets the refrigerator temperature and includes a power shut-off function when turned counterclockwise to the end position. To adjust the temperature, turn the thermostat clockwise in order to reach the recommended 5-6 degrees Centigrade or 41 degrees Fahrenheit. The cockpit refrigerator uses a 15 amp fuse for over current protection located at the ship's DC panel.

When leaving the vessel with goods in the refrigerator make sure the battery charger is on and the dock side cord energized to prevent spoilage.

Usage Recommendations

- If possible, the refrigerator should be turned on for about 6 hours prior to filling food items.
- Frequent opening of the refrigerator door will result in greater consumption.
- Ensure that nothing blocks the refrigerator vent.
- Keep the inside of the refrigerator clean and dry.
- Keep the surface of the door clean and dry.
- The unit has been designed with a product lock protection in the event of low battery voltage. In the event of a compressor block, follow the instruction in the manufacturer's owner's manual or contact a marine technician.
- Note that the compressor can operate up to angles of 30 degrees; greater angles can cause damage to the compressor.
- Note that the unit contains refrigerant type 134 A. In the event of a loss of refrigerant contact a qualified certified technician.
- Periodically clean the condenser unit behind the refrigerator. Dust or vacuum the fan from any dust or lint debris.
- See the manufacturer's owner's manual for defrosting instructions.
- Consult the manufacturer's owner's manual for any troubleshooting information or contact your closest Regal dealer.

Cockpit Sea-grass Matting



If installed, cockpit sea grass mats feature urethane backing for marine environments. The mats provide style, comfort and durability as well as additional protection in environments where microbes are a concern.

Chilewich® products contain Microban®. This antimicrobial protection inhibits the growth of stain and odor-causing bacteria, mold and mildew for the product's life.

When storing your sea grass mats, always roll with the face of product out with the backing facing in. Do not fold or crease as the backing may split. Vacuum or hose off for regular cleaning. Dry face up or hang. Do not machine wash. Matting may be cleaned with a mild detergent and a sponge. Rinse with fresh water. Do not pull on material when removing from cockpit, but rather lift the snap instead to disengage.

Electronics

Various electronics components may be installed on your vessel including HDTV television, satellite KVH system, VHF radio, HD closed radar system, and autopilot.

Each component utilizes individual operator's manuals. Refer to the appropriate electronic component operator's manual for detailed product



information, maintenance and safety tips since the vast amount of information can not be covered here. Basic features and quick start information will be found in the following pages for each component.

For technical service contact your closest Regal yacht dealer who has undergone special factory training on the Regal product line and has the tools and knowledge to maintain your yacht's systems and components,

Furthermore, the internet can help with questions on various components. Use U tube and Goggle to enhance your knowledge on desired products.



HARDTOP WITH ELECTRONICS DISPLAY

Typical Autopilot

If installed, the autopilot can be programmed to maintain a course through the chart plotter route. Easy-to-use setup provides carefree auto-guided navigation in open waters.

Autopilot Operation

The autopilot continuously adjusts the steering on your yacht to maintain a constant heading. The unit can be programmed for both automatic and manual steering functions and patterns.

Before using the auto pilot, be sure to read and understand the autopilot operation manual located in the owner's information packet.

Follow these steps to start-up the autopilot;

1. Energize the "house" battery on the display at the battery panel located at the helm area.
2. Turn on the helm electronic switch.
3. Press and hold the power button briefly to turn the autopilot on or off. If the power button is released quickly instead of briefly holding it the unit will seek the display adjustment screen verses the main screen.

 **WARNING**

AVOID POSSIBLE BODILY INJURY, DEATH
OR PROPERTY DAMAGE!
NEVER LEAVE THE HELM UNATTENDED.
BE PREPARED AT ANY TIME
TO REGAIN OPERATION
OF THE CONTROLS.



General Operation Keys & Descriptions

Power- Turns the autopilot on and off.

Soft Keys- These keys help to navigate through the menus, select items, and change the autopilot steering bearing. The center soft key is used to select highlighted items and open a menu. The left soft key is used to engage the unit or to move back one screen. The right soft key is used to navigate through the menu screens. *Note: Press a soft key to activate the action indicated directly above it.*

STBY (Standby)- Press this button to start the standby function. Press STBY to stop the autopilot from any menu screen at any time. A time when you use STBY might be when you are beginning your route through a tight turning channel to a marina or to your favorite on the water restaurant.

Note 1: When you place the autopilot in standby mode be ready to regain manual control of the boat steering system.

Note 2- The heading sensor is a device that is integrated in the autopilot system that controls the direction inputs and outputs of the unit.

Status- If you press the STBY button on the heading screen “YOU HAVE THE HELM” appears in yellow cautionary lettering. At this point be prepared to manually take control of the helm steering. Under normal conditions on the heading screen the status reads “AUTOPILOT ENGAGED” in green lettering.

Heading- When you engage the autopilot, it takes over the helm steering control and steers the boat to maintain your heading. This heading can be programmed through the autopilot which uses an on board flux-gate compass for bearings based on a magnetic north verses a true north heading. The autopilot heading can also be programmed through the chart plotter to follow a set of way points.

Actual Heading Marker- A yellow triangle (actual heading marker) is displayed and is normally the bearing you are heading.

Note: If the arrow keys are pressed to manually adjust the heading, the heading dial on the heading screen displays your actual heading while the autopilot steers the yacht to the intended heading.

Pattern- This screen icon shows various steering patterns for fishing and other speciality patterns such as zigzag, circles, U-Turn, and Man Overboard. Read and understand the autopilot owner’s manual description of these patterns and make sure the water is free of obstacles and you have an unlimited area to practice these steering patterns.

Radar



Overview



As optional equipment a 4KW (4000 watts) high definition radar dome is installed on a hard top mast. The mast also provides for a masthead/anchor light. The

unit features a dome with a maximum range of 48 miles. The radar is very customer friendly. The radar features a narrow beam width which provides a high resolution image. Dual range operation provides a fully independent split-screen display of far and close radar views in full 8-bit color. See chart plotter manual for additional features.

Operation

To start up the radar do the following:

1. Ensure that the battery management panel is energized.
2. Turn on the helm electronics switch.
3. Depress the power button on the chart plotter to energize the plotter.
4. Choose radar menu on the home screen. You can make it a favorite as shown below.
5. Navigate to desired next menu buttons for more specific radar functions.

For additional information refer to the chart plotter manual, internet, or contact your closest Regal yacht dealer or marine professional. Be sure to read and understand all safety labels related to the radar. *Note that there are some great instructional web based videos that describe the radar screen functions.*



TYPICAL PLOTTER HOME SCREEN

 **CAUTION**

RADAR PRODUCTS EMIT
ELECTROMAGNETIC
ENERGY WHICH IS HARMFUL.
TURN THE UNIT OFF WHEN UNIT
IS BEING SERVICED.

 **CAUTION**

AVOID POSSIBLE EYE INJURY DUE TO
ELECTROMAGNETIC ENERGY.
WHEN RADAR IS TRANSMITTING
DO NOT LOOK DIRECTLY AT THE DOME
WHEN AT CLOSE RANGE.

With the optional satellite antenna installed and an activated subscription you will be able to program and preset Sirius XM audio stations through the “glass cockpit” chart plotter.

Before the subscription can be activated you must have the radio ID on the rear of the Sirius XM tuner. For more information, call 1-866-635-2349 domestically.

Satellite Television (KVH TracVision 3)



KVH. SATELLITE- ANTENNA PORT OPT. RADAR TV ANTENNA SIRIUS XM ANTENNA STBD.

**Components may be optional. Rear view shown.*

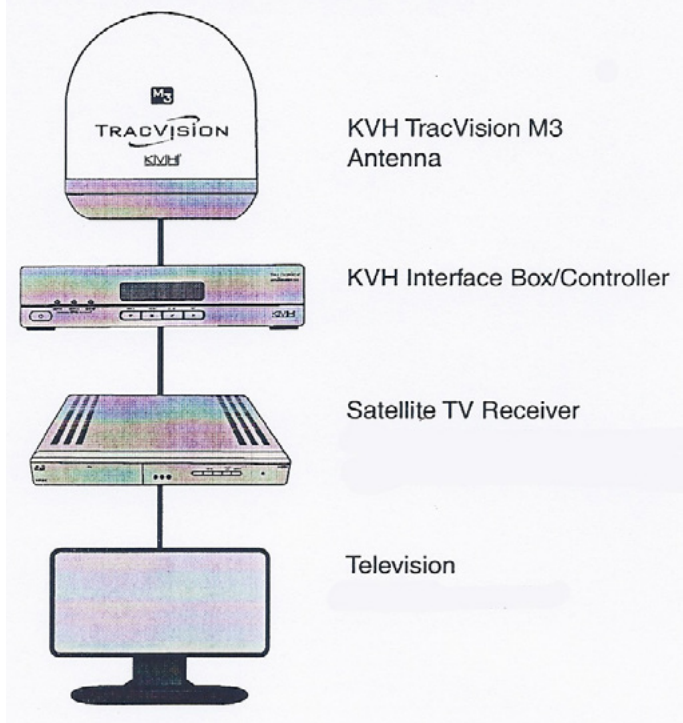

Overview

The optional KVH TV3 Series uses a 14.5" antenna which extends service to cruising areas located within 100 nautical miles offshore in North America.

Under the starboard "dummy" dome is the TV saucer-shaped antenna.

The KVH satellite breaker is controlled by the entertainment breaker at the ship's main AC panel.

Satellite Television Components

If installed, the satellite television option typically features the ability to viewing hundreds of television channels using the vessel 120 volt HD televisions. Basically, the signal is transmitted through an antenna system installed on the hardtop which features a satellite tracking system that automatically finds the satellite for crystal-clear television reception. **To activate satellite television a subscription must be secured. For more information call 1-800-970-9623. Read notice below.**

<h1>NOTICE</h1>
<p>SATELLITE TELEVISION REQUIRES SUBSCRIPTION TO OPERATE. CALL 1-800-970-9623 TO INITIATE SUBSCRIPTION. ONCE ENROLLED THE CORRECT REGIONAL RECEIVER WILL BE ISSUED TO YOU.</p>

System Components-Antenna

The antenna uses modern technology to quickly acquire and track the correct satellite, switch between satellites, and send signals to the interface box. Internal gyros allow the antenna to track the satellite at all times, even with the vessel on the move!

Interface Box-Controller

The interface box supplies power to the antenna system and delivers satellite TV signals to the satellite receiver. This component is also used to set-up the LCD display.

Satellite Television Receiver

The Dish network receiver has been chosen because of its compatibility with the KVH components and is region-specific. This unit receives HD (high definition) signals from 3 DISH network satellites including DIRECTV, DISH network and Bell TV in North America.

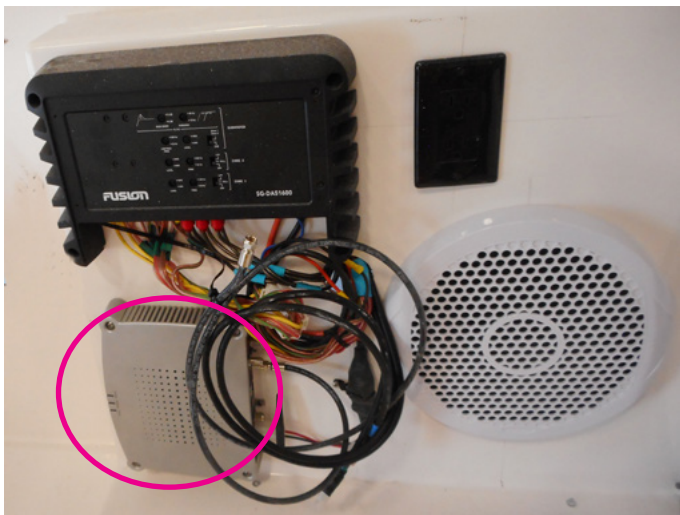

The satellite receiver shown is located at the helm seat inner hull side and can be accessed thru the helm seat locker. The units power requirement is 120 volts AC.

Satellite Weather



This option provides peace of mind and safety by allowing the captain to access the latest weather information through satellite. The data can be

viewed through the GPS/Plotter (option) at the helm or the on board television monitors.

The service provides comprehensive weather data and state-of-the-art forecasting including buoy reports, NEXRAD, lightning, water temperatures, wind and wave current conditions and forecast data.

Access to SiriusXM stations may be available depending on the SiriusXM subscription chosen.

Subscribers can use the SIRIUS satellite footprint which blankets 48 contiguous states, most of Canada and Mexico; and waters extending hundreds of miles into the Atlantic and Pacific oceans, the Gulf of Mexico and Caribbean.

Sirius Marine Weather Activation

1. Power up the receiver by activating the power button on the GPS/Plotter.
2. Dial 1-800-869-5480 to activate the service. The customer normally carries out this operation.
3. Be prepared with your billing information, subscription preferences and the SIRIUS ID# for your receiver.
4. The SIRIUS ID# of your receiver will be viewable via the GPS/Plotter.

Note that the SiriusXM satellite antenna is located under the hard top dummy starboard dome.

Sirius Marine Weather Information

The following information is for United States weather only. A different receiver must be used for worldwide weather.

The weather application superimposes historical, live and forecasted weather graphics and their associated weather data on the GPS/Plotter. All this information allows the skipper to determine the actual conditions in his vicinity or at another location. Weather forecasts and warnings, detailing current and preferred conditions are often updated. For types of warnings, watches and advisories, please refer to the NOAA website at www.nws.noaa.gov.

OPERATION

1. The Garmin receiver must be up and running. Also, it will not work in a covered boat house or dwelling. Activate the electronics breaker.
2. The GPS/Plotter must be energized by depressing the plotter power button.
3. Once opened choose from the menu listing weather. Click into it and you can further select sub menus such as configure, then settings, and systems information and finally to each of the weather option menus such as forecasts, precipitation and fishing.
4. Under systems information you can check your subscription contents.
5. Use the cursor to move around the map and view different locations. Use touch screen for in and out.
6. For additional domestic Garmin service support information call 1-800-800-1020.

Fender Clips

The fender clip option features receivers integrated into the vessel hull side and quick release pins. The quick release pins attach to fenders with lines so they are ready to deploy as needed. When the vessel approaches a mooring the quick release pin with fender is attached to the receiver and pushed into place. This will help protect the boat from dock “rash” which could damage the rub rail or gel coat. When leaving the dock the pins feature a quick release mechanism which detach easily.



FENDER CLIP RECEIVER



FENDER CLIP RELEASE PIN



FENDER CLIP COMPLETE

SeaDek



As an option SeaDek® is featured on select vessel swim platforms and walk through areas. The non-skid, closed cell material is derived from UV protected non-absorbent foam. You will find the product easy to clean with a high stain resistance. Other features include noise reduction, great traction even when wet, body comfort when standing, walking or leaning on the swim platform.

To clean small dirt particles first try soap, hot water and a stiff brush. For surface dirt and footprints use glass cleaner and a clean rag.

If a more thorough cleaning is needed you may use bleach, 409, Simple Green or Soft Scrub. Be sure to rinse thoroughly. Refrain from using any acid base cleaners.

Seakeeper (Typical)

If installed, the Seakeeper uses gyroscopic principles to reduce boat motions in waves and wakes independent of boat speeds. A typical unit consists of a Gyro assembly, a CAN communications cable, and a helm display.

If installed, the Seakeeper is located under the aft cockpit of your vessel. The unit's cycling is controlled by an electronic controller and a hydraulic brake throughout each roll cycle as to supply maximum anti-roll torque and limits mechanical contact with the hard stops that limit the gimbal angle travel.

The Seakeeper operates from DC (direct current) and the unit is part of the house battery circuitry; there is one 8-D battery dedicated to the optional Seakeeper (See battery section). Read and understand the Seakeeper operator's manual before operating the component.

Seakeeper Display

The helm display is used to start, operate, monitor and shutdown the Seakeeper. Sensors, alarms, and shutdowns are provided to allow unattended operation. The display provides information in the event of an alarm. Select alarms can cause the process to stop and start unit into a coast down cycle.

HOME SCREEN SHOWING POWER SWITCH W/TOUCH CONTROL

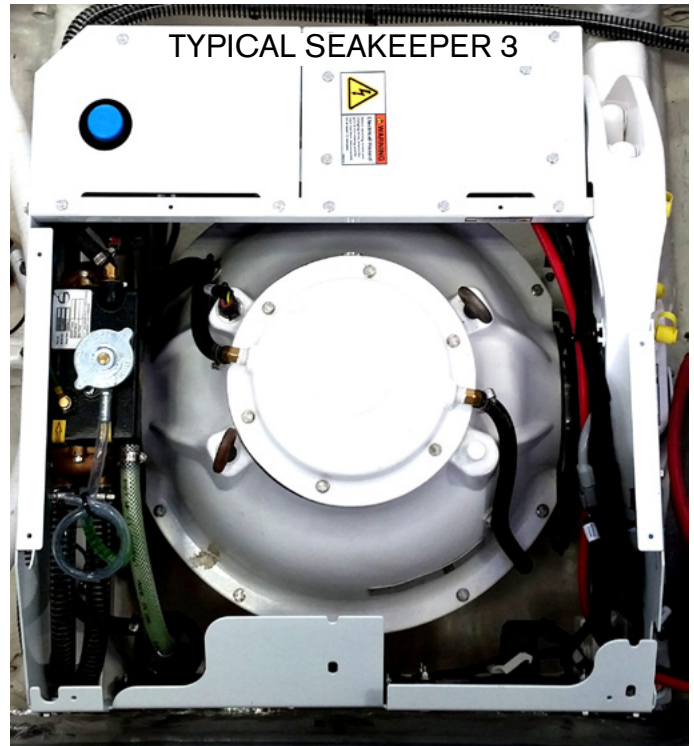
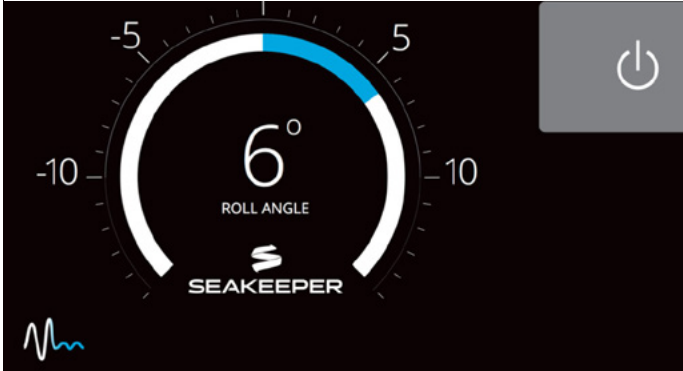

WARNING

AVOID SERIOUS INJURY!
ENSURE THAT ALL BODY PARTS & CLOTHING
ARE KEPT CLEAR OF THE SEAKEEPER
WHILE IT IS CYCLING.

WARNING

AVOID SERIOUS INJURY!
DO NOT REMOVE THE COVERS FROM
THE UNIT OR CONTACT ANY PARTS
WHILE THE UNIT IS PRECESSING.
MAINTENANCE SHOULD NOT BE DONE
UNLESS THE SEAKEEPER IS LOCKED AND
FLYWHEEL HAS STOPPED SPINNING.

After 12 volt power is present. the Seakeeper screen will energize and a home screen will appear. Here the ON/OFF touch screen button will appear grey (OFF). Once the button is pressed it will change to blue (ON) and menu button is used.

When the menu button is pressed, a menu bar will appear or disappear at the screen bottom. The menu bar is used to navigate between pages. Refer to the Seakeeper operation manual for further information regarding the display, operation and understanding the alarm screens.

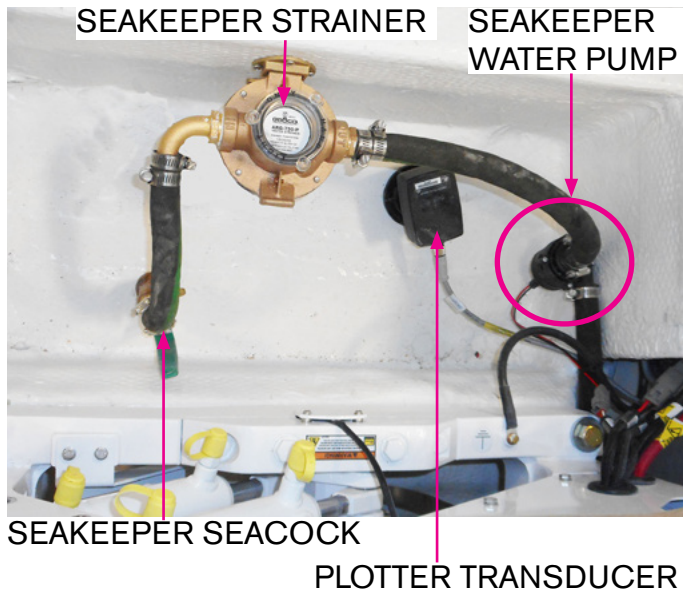

In the bilge mounted close to the optional Seakeeper unit is a water pump. See the above illustration. It is a diaphragm type and it supplies sea water to the Seakeeper unit. *Note that an overheating fault on the display may indicate a water pump problem.*

Also, specifications, troubleshooting, winterization, warranty, and periodic maintenance requirements are found in the operation manual.

Search Light (Typical)



The spotlight feature a 20,000 candle power light beam which can penetrate up to over 1/2 a mile in ideal conditions. The 2 speed searchlight provides

up to 370° horizontal rotation and up to 135° vertical tilt with a dash mounted fingertip control pad. The bulb provides superior light penetration. Included is a protective lens cover.

Note that the searchlight is a radio transmitter and operates at 433 Mhz. When the light is activated, the internally mounted antenna sends out radio frequency (RF) energy. Note that it is possible that this component could affect other electronic equipment. Refer to operator's manual for possible solutions should this occur.

Operation-

1. Using the dash mounted remote control, turn the unit on by depressing the on/off button.
2. Using the same dash mounted remote control rotate your light to the desired location.
3. The light speed can be controlled by depressing the fast/slow button one time and by depressing it again to restore the original speed.
4. The light should not be turned on when the snap on lens is attached. The hard wired dash control will be backlit when the bulb is illuminated.

The dedicated circuit is uses a 10 amp breaker on the power side for over current protection.

The unit uses a Phillips 901 1 bulb replaceable from Golight, Inc. at 800-557-0098.

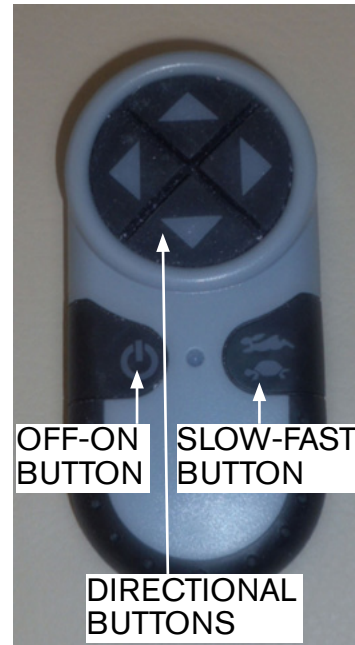

REMOTE CONTROL PAD

Scupper Drains



The cockpit scupper drain system includes several 1 1/2" drains which remove cockpit and recess water and dump it overboard at the port and starboard transom outlets. These

drains are connected by a hose system that runs from the drain under the deck and above the headliner to the transom outlet. These drains feature a removable top screen which can be cleaned and reinstalled as needed. Periodically check these scupper drains for debris.

Sill Drain- Patio

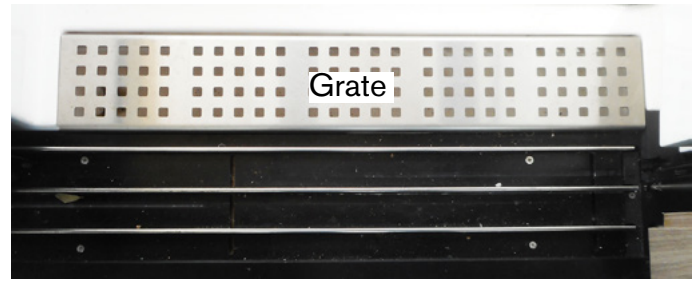

There is a cockpit drain system that includes a trough with a stainless grate located aft of the patio door tracks. Remove the grate to access the trough drain hole. Periodically clean any accumulated debris from the trough.

Sun Lounge (Typical)

The foredeck sun lounge features the utmost versatility as a flat sun lounge, angled head rest position, and as a seat with backrest. See the photos below for select position alternatives.

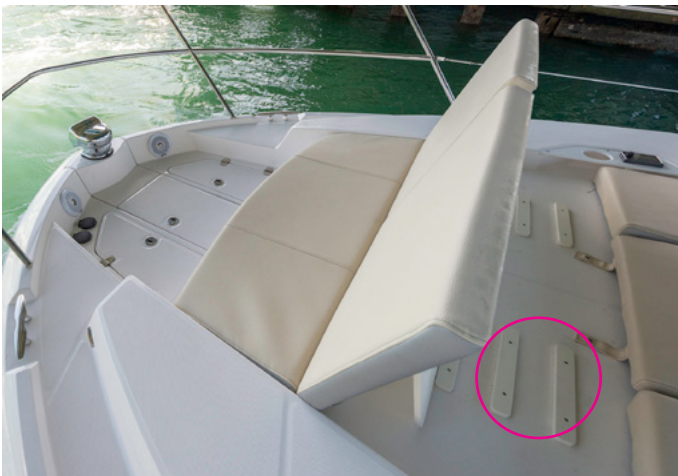

 **WARNING**

AVOID DEATH OR SERIOUS INJURY FROM FALLING OVERBOARD!
DO NOT OCCUPY THE SUN LOUNGE WHEN THE VESSEL IS MAKING HEADWAY.

NOTICE

WITH INCLEMENT WEATHER IT IS RECOMMENDED TO REMOVE THE SUN LOUNGE CUSHIONS AND STORE THEM BELOW DECK TO AVOID CUSHIONS FROM BEING LOST AT SEA OR DAMAGED.

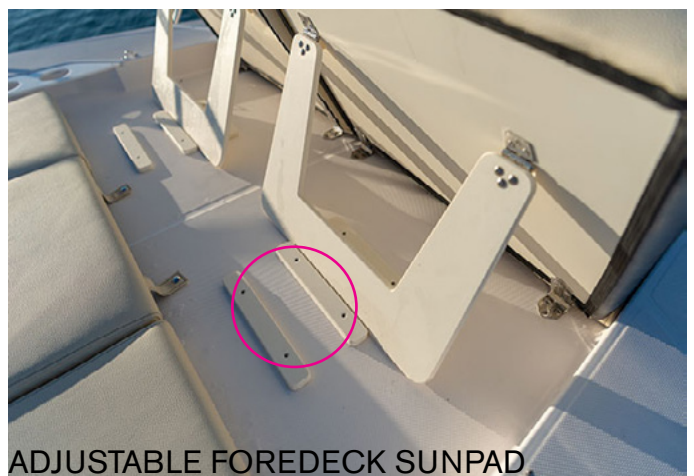

Sun Roof



The sun roof features a fiberglass frame and the ability to open and close with an electric worm gear drive mechanism. At the helm switch panel a sun roof switch controls the sun roof open and close cycle. Press the top portion of the switch to open the roof; press the bottom portion to close the roof. The switch is controlled by a 10 amp breaker located at the helm seat gunnel locker. The sun roof slides on a track. The sun roof is fully sealed to prevent leaks. Read and understand the following warning label.

When leaving the boat unattended for extended periods of time be sure to completely close the sun roof.



WARNING

AVOID BODILY INJURY!
KEEP BODY PARTS CLEAR OF SUN ROOF
DURING OPENING AND CLOSING
OPERATIONS.



WARNING

AVOID BODILY INJURY OR DEATH
DUE TO FALLING!
NEVER STAND ON TOP OF THE SUN ROOF
OR THE HARD TOP STRUCTURE.

The system is part of the DC low voltage on board circuitry. Should service be needed to the sun roof system contact your closest Regal yacht dealer for more information. They have the training know how along with the tools to tackle system components.

The sun roof features a control box to set the sun roof opening and closing speed along with its actual closing position limits. This box shown below is located behind the helm. The port plotter must be removed to access the control box.



WARNING

AVOID BODILY INJURY
DUE TO CRUSHED LIMBS!
KEEP ALL BODY PARTS CLEAR OF SUN
ROOF WHEN ACTIVATED.

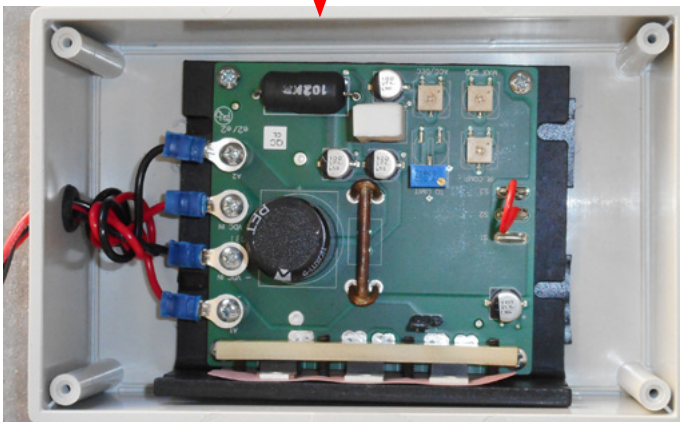

Stove- Cook top

Overview

The electric stove (cook top) on your vessel will afford you years of service. Read and understand the information here and in your cook top owner's manual. Pay close attention to all safety instructions.



The cook top features 240 volts of AC electricity for faster cooking similar to a home unit. It is controlled by a 10 amp breaker at the main ship's AC panel located behind the atrium stairway cabinet doors.

The cook top features a limit switch installed in the storage track for the cook top cover at the cabinet directly below the cook top. The cook top will not operate until the cook top cover is installed on the track and covers the limit switch. At this point power will be available to the cook top surface units. See the illustrations to the right.



SWITCH ON & POWER TO Cook top
MASTER ON/OFF CONTROL.
NOTE: COVER IN TRACK OVER SWITCH.



SWITCH OFF & NO POWER TO Cook top
MASTER ON/OFF CONTROL.
NOTE: COVER IN PLACE OVER Cook top.



Shown is the cook top circuit limit switch control box. It is located inside the lower cook top cabinet. No periodic maintenance required but access to it is

best gained by removal of cook top unit.

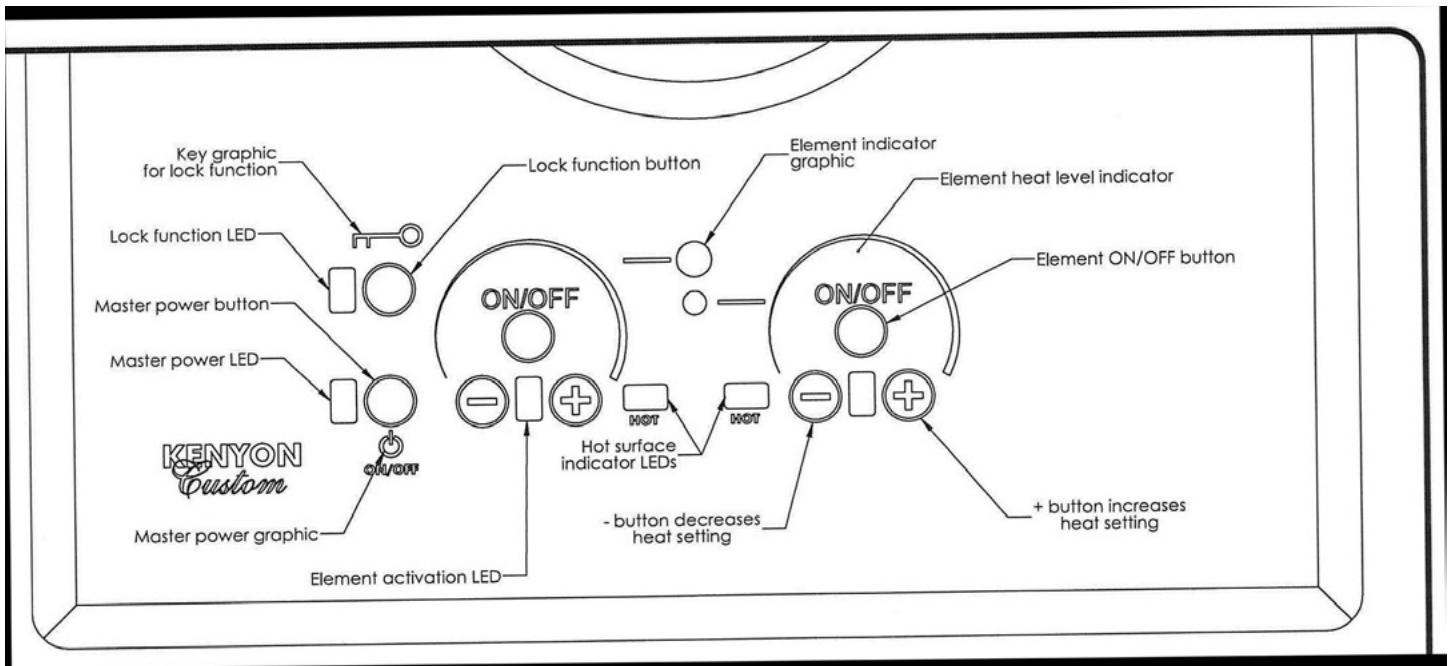

Operation

If this is the first time use make sure the plastic film covering the cook top has been removed and the recommended cleaner is used to coat the surface. Refer to cook top manual.

As a quick start for the stove do the following and refer to the diagram above as needed.

1. Energize the stove breaker at the ship's main AC panel.
2. Remove the cover from the cook top and insert it into the track under the cook top cabinet. Make sure it covers the limit switch. Power is now available at the cook top master control if the lock feature is off.

Note that there is a lock feature that may or may not of been energized. Make sure the key graphic is not lighted. If the light is energized, press the lock function button and hold for 3 seconds. A beep will be heard and the light next to the key graphic will go out. The cook top master power is ready to operate.

3. Next, the cook top uses a 2 step on, and 1 step off for safety reasons, requiring at least 2 different touches of the controls to activate the element, but only one touch to deactivate an element or the entire unit.

4. To activate a heating element (burner) the master power must be energized by placing and holding a finger over the circular area next to the master power graphic. An audible beep will be heard and a light next to the master power graphic will be illuminated. Next, the desired element must be turned on, by placing a finger over the circular area marked ON/OFF for that element. An audible beep will sound and the light will be illuminated.

At this point a heat level is chosen by holding a finger over the circular areas marked with a + or -. Touching the + will set the level from settings 1 thru 8 with a beep and corresponding number of lights illuminated. Touching the - first will set the level from settings from 8 to 1 with a beep and the corresponding number of lights illuminated. When the desired heat level is obtained, remove the finger and cook top remains at that temperature.

If an element is activated, but no heat level chosen, the element will automatically turn off in 10 seconds.

To change the heat level place finger on + or - graphic of desired element to change heat level incrementally up or down.

To activate an element, touch circular area marked ON/OFF to turn the element off. Furthermore, the master power ON/OFF can be touched and the entire cook top can be deactivated.

A hot surface indicator light will illuminate when an element is energized and has been energized for enough time to produce unsafe to touch temperatures of the cooling surface. The light will remain illuminated until the surface is cool.

To power off both elements at the same time, touch the circular area next to the master power ON/OFF graphic. This can be done without deactivation of the elements if any are in operation, and is an important safety feature allowing the operator a “one touch off” in case of emergencies. All functions will no longer operate until the master power is turned on again.

Stove (Cook top)- Safety/Use Tips

1. Never use the stove for warming or heating salon.
2. Do not leave children alone or unsupervised in the salon with the stove in operation.
3. Wear garments that are not loose as they have less chance to ignite.
4. Flammable products are not to be stored on board the vessel especially not in stove cabinets or on salon counter tops.
5. Keep flammable materials away from stove.
6. Do not use stove when vessel is making headway.
7. Always have a dry chemical or foam type fire extinguisher on hand. Do not use water to put out a grease fire.
8. Use dry pot holders only as damp ones may cause burns from steam.
9. Never cook on a broken cook top. Do not use stove until the unit/glass top is replaced. Turn the stove breaker off at the ship's main AC panel.
10. Clean stove top only when it has cooled down.
11. Pan size; shoot for pan that is twice burner size to prevent pan from spilling or moving off stove top.
12. Never leave cook top unattended when cooking. Boiled over grease may ignite.
13. Used only approved glazed utensils for cook tops.
14. Turn all utensil handles inward and do not extend them over adjacent surface units.
15. Do not use aluminum foil on cook top surface.
16. Cookware should be dry.
17. Never touch surface units or areas close to the burners.
18. Never store items on the cook top when not in use.
19. Wait until all surface units are cool before reinstalling the cover.

NOTICE

THE COOK TOP FEATURES A THERMAL CUT-OUT. IF THE TEMPERATURE OF AN ELEMENT REACHES AN UNSAFE LEVEL THE THERMAL CUT-OUT WILL OPEN AND POWER TO THE ELEMENT WILL BE TURNED OFF. WHEN THE ELEMENT HAS COOLED TO A SAFE TEMPERATURE THE POWER WILL BE RESTORED AUTOMATICALLY.



CAUTION

AVOID POSSIBLE FIRE HAZARD!
DO NOT STORE ITEMS ON THE Cook top WHEN NOT IN USE TO PROTECT ITEMS FROM MELTING SHOULD THE Cook top BE TURNED ON INADVERTENTLY.

Swim Platform/Ladder



Overview

The swim platform is an FRP component with an anti-skid surface or optional SeaDek covering. The swim platform and ladder provide a safe haven to disembark to a dock or for the latter to enter or exit the water. Always use the ladder when entering or exiting the water to prevent possible injuries from falling or from sharp objects such as propellers and stern drive units. If installed do not exceed swim platform safe weight limits. Do not dive from the swim platform. Read and understand any safety labels regarding the swim platform/ladder.



WARNING

AVOID INJURY OR DEATH
FROM DROWNING DUE TO CO POISONING!
NEVER HANG FROM OR ENTER
UNDER THE SWIM PLATFORM
STRUCTURE OR APPROACH THE SWIM
PLATFORM/LADDER WITH ANY ENGINE
OR GENERATOR RUNNING.



WARNING

AVOID INJURY FROM FALLING!
WHEN USING THE LADDER WHILE
ENTERING OR EXITING FROM THE WATER
ALWAYS USE THE HAND HOLD.



Note that select swim platforms may include Regal logos etched “footballs” which are inset into the swim platform surface. They assist in releasing into the atmosphere any CO contaminated air from engine exhaust that may be trapped under the platform structure. Ensure they are always open thus enabling them to release any accumulated exhaust into the atmosphere.

Note not to sit on the swim platform with the engines running to avoid the effects of possible CO poisoning.

Additional Swim Platform Tips

If installed, never use cleats for hauling vessel in/out of water. Use proper located and sized straps. See drawing in technical section of this manual.

Never wrap lifting straps around the swim platform to lift the vessel. Use designated hull lift locations. See technical section.

Periodically check all swim platform parts for tightness and corrosion.

Swim Platform/Ladder Usage Tips

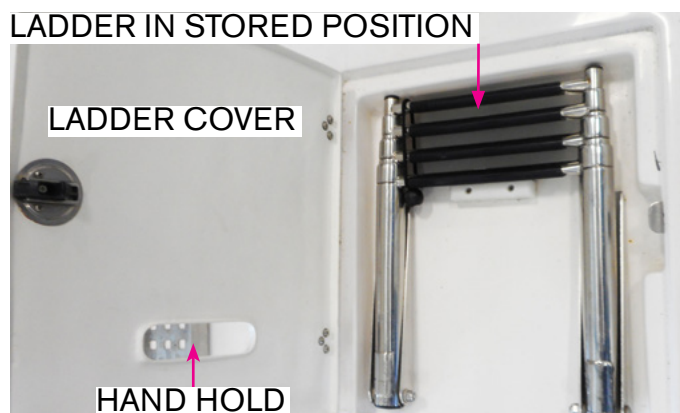

1. Always keep the swim platform free of any objects. Never store items on the platform as they could cause falling incidents or objects such as lines may become caught in the engine propellers.
2. Always keep the transom door leading to the swim platform latched except when using door.
3. Always fold up the swim ladder and close the ladder cover when finished using it.
4. Never leave the ladder down when the boat is under power.
5. When opening or closing the ladder framework be careful to keep limbs and fingers free of moving parts.
6. Periodically check all ladder parts for tightness and corrosion.

Table (Typical)

The table features teak a hardwood known for beauty and durability. Typically the table is stored in the starboard aft salon seat. Pull backrest forward for table access.



A TABLE SUPPORT

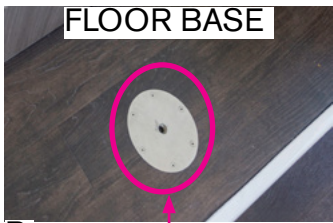

B



C

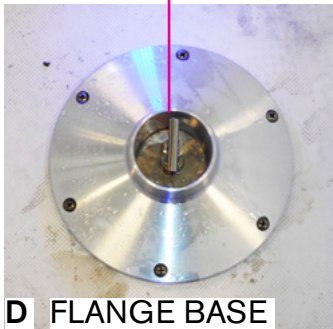

D FLANGE BASE



FLANGE

Setting Up Teak Table

1. Remove the table from its storage area.
2. Find the flange base.
3. Unscrew the flange base center hold down mechanism and the entire unit will free itself.
4. Center the flange base over the floor base (B) and line up the center holes. Normally there is a floor base in the patio (aft cockpit) and in the salon. Screw the hold down T handle mechanism clockwise until tight.
5. Find the table leg.
6. With the table turned over loosen the knob on the table support.
7. Insert the leg into the table support. Tighten the knob until secured.
8. Lift the table and leg assembly up and insert into the flange base. Wiggle the sides of the table as needed until the leg is completely down.
9. To disassemble the table reverse the process.

Note that it is recommended that the table assembly be stored before making a major cruise into rougher seas or other adverse weather conditions.



TYPICAL TEAK AFT COCKPIT TABLE

Transom Door



To open or close the transom boarding door pull up on the framework top rail of the door. Swing door to a detent which will afford an open or closed position. Push down to latch in detent position. See the above photo.

Note the door features a space underneath which provides room for water to escape the cockpit in rough seas or heavy rain activity.

Read the safety label below. While underway and even in mooring to prevent anyone from falling overboard always latch the transom door.

	WARNING
AVOID INJURY OR DEATH FROM FALLING OVERBOARD! ENSURE THAT THE TRANSOM DOOR IS IN A LOCKED POSITION AT ALL TIMES.	

Vacuum Cleaner System- Central

The vacuum system is located in the forward state-room at the starboard wall of the berth. Included is a netted bag of hoses and various vacuum attachments normally stored under the forward berth.

Safety Warnings

1. This is a dry vacuum system. Do not use on wet surfaces.
2. Never operate the vacuum without filters and bags in place.
3. Use careful monitoring when children are around. Do not let the vacuum cleaner be used as a toy.
4. Do not try to repair the vacuum as the unit is sealed. Return the unit to InterVac or an authorized repair center for proper repairs.
5. Use only as described in this manual. Use only factory attachments and bags.
6. Do not use with any blocked openings. When the secondary filter becomes dirty, rinse in warm water or replace the filter. Filters must be completely dry before using.
7. Never drop or put any object into any opening.
8. Turn off the accessory breaker at the ship's AC panel to deactivate the vacuum cleaner.
9. Keep all body parts and clothing away from any moving parts.

10. Do not pick up anything that is burning or smoking such as cigarettes, matches, hot ashes or sharp objects. Do not use without dust bag or filters in place.

11. Do not attempt to operate the unit with a wet hose.

12. Do not store objects close to the vacuum unit.

13. Do not pick up flammable or combustible liquids such as gasoline, or use in areas where they might be present such as the bilge.

14. Do not step on the hose, nozzles or pull hard on the hose.

Operation

1. To operate the vacuum energize the appropriate accessory breaker at the main ship's main AC panel.

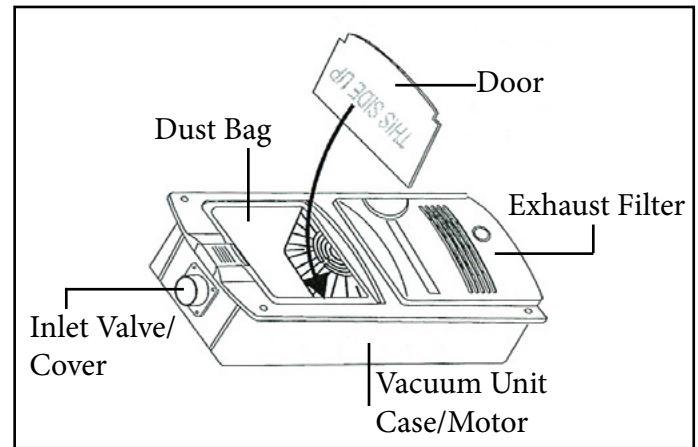

2. Lift the inlet cover on the vacuum unit.

3. Insert the hose cuff (one with the metal band) with a slight twist and the vacuum cleaner should start.

4. To remove, turn hose in either direction while pulling the hose toward you and the vacuum cleaner will stop.



INSERT HOSE CUFF HERE

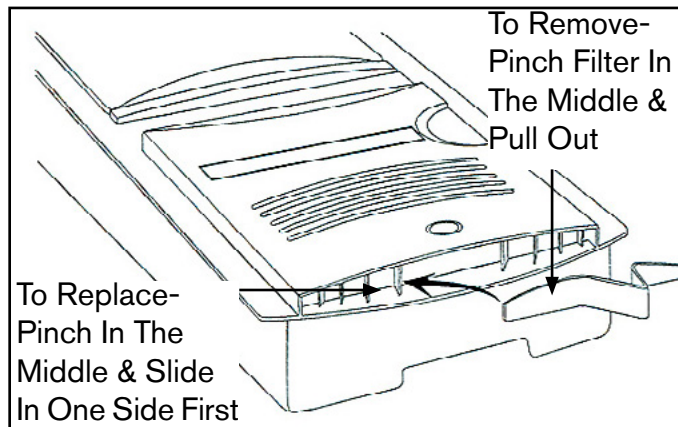

REPLACING EXHAUST FILTER

If The Motor Stops Suddenly:

1. The most common cause is a clogged hose. Try to unclog the hose with a long object or by shaking the hose until the debris falls out.
2. The bag is overfilled and fine dust has clogged the bag.
3. The vacuum cleaning tools are clogged.
4. The motor (exhaust) filter is dirty and should be cleaned or replaced.
5. While the vacuum cleaner is being used keep the berth open to provide additional air to the unit. This will help the unit from shutting down.

Note if the motor stops the thermal protector on the unit will reset automatically after about 1/2 hour. This is normal for the vacuum cleaner.

Underwater Lights



As an option lighting fixtures w/ blue LED clusters make up the underwater lighting system. The 5 lights may be located on the transom along with the port and starboard hull sides. There is a dash switch for energizing the lights and a breaker under the dash to protect the system. These lights operate around 4500 (daylight category) on the Kelvin scale and provide maximum lumens, long life, and low operating temperatures.

Vessels may use the rectangular configuration as shown below.



Walk Thru Door- Patio

The integrated walk thru door at the starboard gunnel provides easy access for entering and exiting higher dock structures from the vessel. To use, remove the seat cushion and lift the door from its magnetic latch. Pull door toward bow of vessel (arrow). It will rest against the backrest frame. Always re-secure door before leaving the mooring or dock making headway. Operator when approaching a high pier should position the vessel as needed to afford safe disembarking for his crew and passengers using the walk thru door.

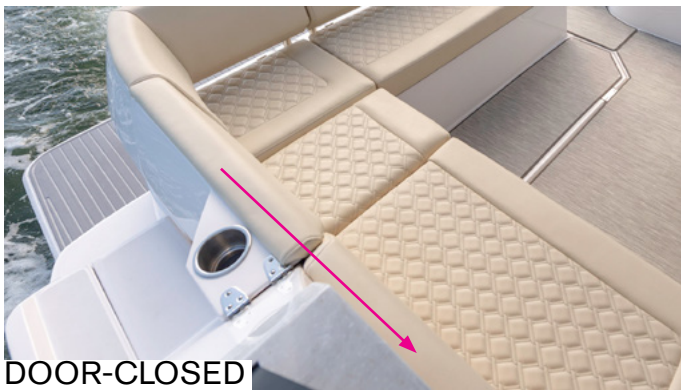

Windshield Wipers/Washer System

Port and starboard windshield wipers feature a planographic design which keeps constant pressure on the wiper blade to ensure a more efficient removal of water on each sweep. The wipers also feature a washer system.

Note that windshield damage may result if the wiper blade is run over a dry windshield.

Periodically check the wiper blade for excessive wear and replace as needed. It is always a good idea in rain prone environments to store extra wiper blades on board.

Refer to the systems chapter for additional information.



TYPICAL WIPER WASHER

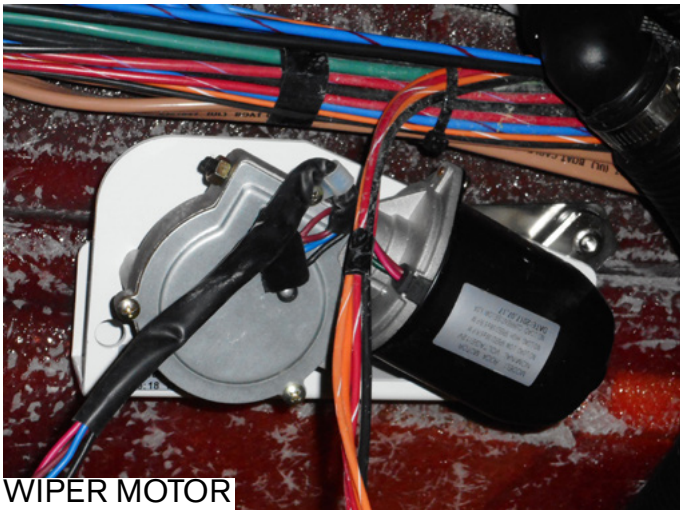

WIPER MOTOR



WIPER WASHER

Note that the windshield wiper motor and the wiper washer unit are accessible thru the whisper wall ceiling fabric. Contact your closest Regal yacht dealer for additional information since special tools and knowledge are required.

Chapter 8

Care & Maintenance

Cosmetic Care

This section covers the care and maintenance of your Regal boat. Many cosmetic care topics including exterior hardware, upholstery, fiberglass and canvas are covered along with major equipment and systems. Refer to the owner's information packet and the appropriate outboard engine manufacturer's manuals for further detailed instructions.

Upholstery

Cockpit and interior vinyl require periodic cleaning to maintain a neat appearance and to prevent the build up of dirt, mildew and contaminants that may stain and reduce the vinyl life if they are not removed. The frequency of cleaning depends on the amount of use and conditions to which the vinyl is subjected. Most common stains can be cleaned using warm, soapy water and clear rinses. Scrubbing with a soft bristle brush will help loosen soiled material from embossed surfaces and under welting. If the stains are not removed with the above method use a mild cleaner such as Fantastic. This cleaner should be used only as needed and not the normal means.

With more stubborn stains, rubbing alcohol or mineral spirits may be tried cautiously. Widespread solvent use can severely damage or discolor vinyl. Try to remove stains immediately before they have a chance to penetrate the surface of the vinyl.

Powdered abrasives, steel wool, or industrial strength cleaners are not recommended for cleaning our vinyl. Lacquer solvents will cause immediate damage. Dilute chlorine bleach before using. Do not wax the vinyl as it may cause cracking. Always wear protective gloves and make sure there is sufficient ventilation when cleaning vinyl. Wear eye protection.

Remember that suntan oil will damage vinyl. Use suntan lotion instead of suntan oil. Exposure to the sun is a natural enemy of vinyl upholstery. Keep the vessel covered with a cockpit cover when not in use.

Cockpit Carpet

Use approved cleaners on carpet. Always try on a test area first. Many spots and spills can be removed using a cleaner combined with a clean, white terry towel. Try not to soak an area excessively and do not use solvents because most interior carpet is rubber backed and glued in place. Solvents and abrasives will break down the backing and fibers. Note: Always roll up cockpit carpet before towing your boat. Store carpet in a locker.

Plastic

Use plastic cleaners and polishes recommended for marine use only. Use proper applicators. Read all instructions carefully. Test the product in a small area first. Use a soft rag and always rinse the surface with water. Ammonia based cleaners and abrasives will damage plastic parts.

Acrylics

The companionway door on select models is one item made from a heavy acrylic material. Use warm water and a couple drops of mild detergent. The cleaning rag should be lint free and thoroughly rinsed. Do not substitute paper towels, which could lead to fine scratching of the surface. With the right cleaning materials, you can easily remove most dust and grime without creating an additional static discharge.

Do not use an abrasive or scouring pad. Acrylic must not be exposed to organic, oil-based solvents. This includes:

- Acetone/nail polish remover
- Paint thinner or comparable
- Benzene
- Rubbing, denatured, or other alcohol-based solutions
- Carbon tetrachloride

For scratches and other marks that do not respond to basic cleaning, polishing is the way to renew your acrylic. Again, use a soft, lint-free cloth. You can hand polish or use a polishing machine.

Apply the polish in a snake like or S pattern across the surface first horizontally and then vertically. Smaller polish jobs can use an L shape followed by a circular motion. If you are still not able to remove the blemish the scratch is probably too deep. In these situations, the only recourse is an incremental wet sanding, finishing with an #800 grit abrasive, and another coat of polish. After polishing any residual product remaining should be removed.

NOTICE

AVOID CLEANING PLASTIC SURFACES WITH A DRY CLOTH OR GLASS CLEANING SOLUTIONS CONTAINING AMMONIA. NEVER USE SOLVENTS OR WIPE WITH ABRASIVES.

Interior Fabrics

Clean flat good interior fabrics with dry cleaning fluid style cleaners approved for use with soft fabrics. Allow adequate ventilation and follow the label instructions carefully. Use a soft cleanser with feldspar to clean stubborn marks or stains on wallpaper. Normal interior vinyl such as used on the headliner on cruisers and head clean up with a mild soap and water solution. Rinse immediately with clean water and wipe dry. Always test an area with a cleaner before applying it to a larger area.

Fiberglass & Gel Coat

 **DANGER**

AVOID SERIOUS INJURY!
WAXED GELCOAT SURFACES CAN BE VERY SLIPPERY! DO NOT WAX NORMALLY USED AREAS OF THE DECK, LINER, OR GUNWALES. DO NOT WAX ANY TEXTURED OR NONSKID SURFACES SUCH AS FLOORS, WALKWAYS, STEPS, LADDERS, OR SWIM PLATFORMS. WEAR NON-SLIP FOOTWEAR WHEN WALKING ON VESSEL SURFACES!

NOTICE

WIRE BRUSHES, SCOURING PADS, OR OTHER ABRASIVE TYPE MATERIALS AND SOLUTIONS SHOULD NEVER BE USED ON THE HULL OR DECK. THEY CREATE SMALL SCRATCHES THAT COLLECT MARINE GROWTH.

Routine maintenance is the only practical way to keep the surface of your boat looking shiny and new. Most objects left outdoors will gradually deteriorate from exposure to the sun, water, dust and pollution. Such outdoor exposure can cause your boat's gel coated surface to change or fade. Darker colors tend to fade more rapidly than lighter colors because they absorb more of the sun's rays (ultra-violet and infrared).

Basic maintenance includes monthly washing of the boat's surface to remove normal accumulation of soil and stain.

Use a mild detergent such as dishwasher powder or liquid. Do not use automatic dishwasher detergent. Avoid any kind of alkaline cleaners such as trisodium phosphate (TSP), abrasives, bleaches and ammonia. For best results use cleaners that are recommended for fiberglass.

It is recommended that you wax the gel coat surface twice yearly to prevent loss of gloss and to protect the finish. Use only waxes for fiberglass and follow the label instructions. Apply a 3' x 3' section at a time using clean applicator cloths or a buffing bonnet. When a haze develops, use a power buffer at low speeds (1200-2000 rpm) to remove the haze. Keep the buffer moving to avoid heat buildup. The power buffer is very efficient at removing contaminants from gel coat. Never wax gel coat in the direct sun.

When the washing and waxing as recommended does not restore the shine it may be necessary to use a fine rubbing compound. Do not apply rubbing compound in direct sunlight. A power buffer at low speed does an excellent job to remove impurities from the gel coat that cause dulling. Use light pressure and keep the buffer moving. Re-wax after compounding to buff the surface.

“Hairline cracks” or “spider webbing” could develop in the gelcoat surface of a hull or deck. This can be caused by impact or other factors. Small air pockets or gouges may also occur through normal wear.

These do not affect the strength of the hull or deck and can be repaired by yourself, a marine professional or a Regal dealer.

The affected area should be chipped or sanded away and a thin layer of color matched gel coat applied. This layer is then sanded smooth and buffed to its original luster.

Most minor scratches, nicks, and dents can be removed by compounding the surface. Marine type compounds can be found at most auto body supply stores. Specify a number 25 which is a coarser compound up to a number 55 being less coarse. Various glazes and polishes are available as needed. Ask your marine professional or Regal dealer for more information.

Fiberglass hulls are strong but they can be damaged. A fiberglass hull has virtually no internal stresses. Thus when a part is broken or punctured, the rest of the hull retains its original shape. A severe blow will either be absorbed or result in a definite localized break. A break of this nature should be checked and repaired by a marine professional or a Regal dealer.

Minor Repairs

You will need the following materials for minor repairs:

- Gel coat
- Clear Liquid Catalyst
- Putty Knife
- Razor Blade
- Fine Sandpaper (400,600,1000)
- Wax Paper (to cover repair area)

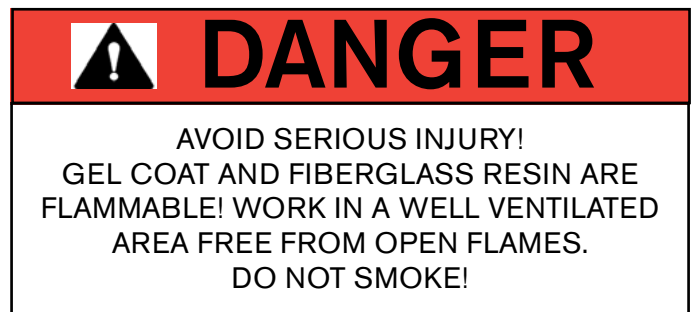

For minor repairs refer to the following procedure:

1. Clean the area to be repaired and get rid of any wax or grease residues.
2. Clean out scratches, chips, and nicks.
3. Sand area to be repaired so gel coat will bond.
4. In a separate container, measure only the amount of gel coat you will need. Mix a ratio of 2% catalyst to the amount of gel coat being used (a spoonful of gel coat will require only a drop or two of catalyst). Do not pour any unused portions of the gel coat/catalyst mixture back into either original container.

5. Apply gel coat to area leaving a slight lift above the surface.

6. Cover the area with wax paper. It will help the mixture to set up faster.

7. Remove wax paper and shave off any extra gel coat with a razor blade.

8. After the area is shaved smooth, start with the 400, 600, and finally 1000 grit sand papers.

9. Buff the area with compound, polish and a finish wax. You may notice a difference between the repaired area and the original finish due to the natural weathering process.

Canvas

Boat canvas is in most cases subjected to more severe punishment than practically any other type of material. Moisture, dirt and chemicals from industrial fallout, heat, ultraviolet rays and salt water are all factors which accelerate the deterioration of your boat canvas. These elements can cause serious damage if left unchecked.

The boat top and other canvas supplied on your Regal boat are manufactured from top quality materials to provide you with years of trouble free service. The following information on the care, cleaning and proper storage of the fabrics and fasteners that make up your marine canvas is being provided to help you maintain the appearance and ease of operation.

Sunbrella General Information

Sunbrella is used on bow and aft manual sun shades (if installed). Sunbrella is a woven fabric made from 100% solution dyed acrylic fiber. It is color fast and will withstand long term exposure to the sun (ultra-violet rays) without excessive fading.

Even though it is treated with water repellency some "misting" through the fabric is typical. With new canvas, the greatest potential for leakage is through any sewn seams. Because Sunbrella and the long term thread used is synthetic, the holes created by sewing will not swell up and seal when exposed to water as cotton does. Usually the movement of the fabric in use will move the fibers enough to seal the holes. You may apply Apseal or Uniseal to the seams to speed up this process.

When the canvas is new, the fit will normally be tight. It is designed this way because Sunbrella stretches as it ages. The initial tight fit allows for a suitable fit for the life of the canvas. The Sunbrella fit will vary slightly in the heat, cold, and rain.

Sunbrella canvas should be cleaned regularly before substances such as dirt, roof particles, etc., are allowed to accumulate on and become embedded in the fabric. The fabric can be cleaned without being removed from the boat. Simply brush off any loose dirt, hose down, and clean with a mild solution of natural soap in lukewarm water. Rinse thoroughly to remove soap. **DO NOT USE DETERGENTS!** Allow to air dry.

For heavily soiled fabric, remove the top from the frame.

Soak the fabric in a solution that has been mixed to the following proportions.: 1/2 cup of bleach and 1/4 cup of Ivory or Lux soap (liquid or soap) per each gallon of lukewarm water. Allow the fabric to soak until the bleach has killed the mildew and the stains can be brushed out with a common kitchen scrub brush. Rinse the fabric thoroughly in cold water to remove all the soap. This may require several rinsings. Incomplete rinsing can cause deterioration of sewing threads and prohibit the fabric from being properly retreated. Allow the fabric to dry completely. **DO NOT STEAM PRESS OR DRY IN AN ELECTRIC OR GAS DRYER!** Excessive heat can damage and shrink the fabric since it is heat sensitive.

This method of cleaning may remove part of the water and stain repellent that was applied to the fabric during its manufacture. It is recommended to retreat with such water repellency products as Apseal and Uniseal. We do not recommend any wax based treatments such as Thompson's Water Seal or any of the silicone products such as SC-15 or Aqua-Tite. Wax based products prevent the fabric from breathing, and encourage mildew growth while the silicone products interact with the original fluorocarbon finish and seem to cause a rapid loss of water repellency.

Clear Vinyl, Zipper & Snap Care

Never store canvas wet or in an unventilated, moist area. Always roll the canvas instead of folding. This is of particular importance on side curtains or any other part with the clear vinyl "glass". Roll the top carefully around the bows and cover with the storage boot provided.

The clear vinyl "glass" used in side curtains, aft curtains, visors, and camper enclosures is very susceptible to heat and cold. Keep vinyl curtains from touching metal tubing to minimize burning the vinyl. If the boat is stored with top, side curtains and aft curtain in place, heat build up inside the boat may discolor the vinyl. To clean the clear "vinyl" glass, use a solution of Ivory or Lux soap, liquid or flakes, and lukewarm water. Allow to air dry. Never use any type of abrasive cleaner as it will scratch the "vinyl" glass. There are many cleaners and scratch removers on the market specifically for clear vinyl. Handle the clear curtains carefully. They are soft and prone to scratching.

Canvas parts are designed with zippers. When zippers are new they can be a little difficult to use. Zip carefully without forcing the zipper or the material. They will loosen with use. A zipper lubricant may be used to help new zippers as well as maintaining used ones. The most vulnerable part of the zipper is the starts. Use care when beginning to close the zipper.

Canvas snap fasteners should be unsnapped as close to the button as possible. Never remove canvas by pulling roughly on the edge of the material. This can damage the canvas as well as the fasteners. Use petroleum jelly on snaps to keep them from developing corrosion especially in harsh environments.

Metal

Keep all stainless steel and other metal parts rinsed and wiped dry. To maintain their finish annually polish the stainless steel and other bright works at least annually. Use commercially available metal products and read the labels carefully before use. Refer to the flyer in the owners information pouch. Most marinas and boating retail outlets carry metal care products.

Hull Bottom

Never use wire brushes or highly abrasive scouring pads on your hull bottom. It could damage the gel coat surface or the bottom paint. The bottom of your boat needs to be clean since the build up of natural coatings from water or marine life can potentially create drag and affect your boat's performance.

FREQUENT STAINS/CLEAN-UP STEPS	1	2	3
Coffee, Tea, Chocolate.....	B		
Permanent Marker*.....	E	B	C
Household Dirt.....	A	B	
Grease.....	D	B	
Ketchup, Tomato Products.....	A	B	
Latex Paint.....	A	B	
Oil Base Paint.....	D	B	
Mustard.....	A	B	C
Suntan Oil.....	A	B	
Asphalt/Road Tar.....	D	B	
Crayon.....	D	B	
Engine Oil.....	B		
Spray Paint.....	B		
Chewing Gum.....	D	A	
Shoe Polish*.....	D	B	
Ballpoint Pen*.....	E	B	A
Lipstick.....	A	B	
Eyeshadow.....	E	B	
Mildew*.....	C	B	A
Wet Leaves *.....	C	B	A

A= Soft brush; warm soapy water/rinse/ dry

B= Fantastik cleaner

C= One tablespoon ammonia, 1/4 cup of hydrogen peroxide, 3/4 cup of warm water/ rinse/dry

D= Scrape off residue (use ice to lift gum)

E= Denatured alcohol/rinse/dry

* These products contain dyes which leave permanent stains.

Maintenance

Propellers

Out-of-balance and nicked propellers will effect performance or cause vibration. Damaged props should be replaced, but those that are chipped or bent can usually be reconditioned by a marine dealer or a propeller repair facility. When cruising, consider carrying a spare set of props on board because many marinas do not carry a full inventory of replacement propellers. Also, carry an extra set of prop hardware. Refer to the outboard manufacturer's engine manual for appropriate propeller replacement.

Be sure to make a note of the propeller diameter and pitch while the vessel is in dry dock. They are pressed into the prop for easy reading.

Also, note that propellers feature a rubber hub pressed into the center propeller that includes the hole for the prop shaft to slide through. Sometimes as a result of impact the rubber hub becomes damaged and the propeller will not let the boat perform to the rated revolutions per minute (rpm).

In an emergency a stainless propeller blade may be straightened by laying the propeller blade on a 2 x 4 and hammering the bent portion of the blade until straight. The above process works better with a softer aluminum propeller.

It is advantageous to carry the needed tools to change propellers including pliers to pull cotter key and deep socket and ratchet to remove the propeller shaft nut. Outboard propeller shown in the diagram below. Check the Volvo operator's manual for stern drive propeller information.

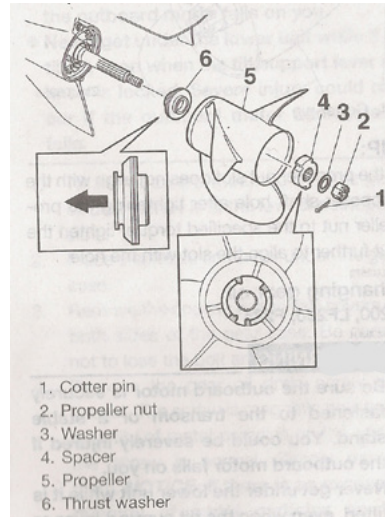

Removing the propeller- Before removing the propeller make sure the remote control is in neutral and the ignition keys are removed to prevent the outboard engine starting and possibly causing bodily injury.

Always wear gloves

when removing or installing propellers since the component blades are very sharp.

1. Use pliers to straighten the cotter key which will permit it to be pulled through the prop shaft.

2. Do not use your hand to hold the propeller while removing the nut.

3. Wedge a 2 x 4 between the skeg and the propeller. Then use a deep socket and ratchet to remove the propeller nut.

4. Next, remove the washer and spacer. Remove the propeller. Remove thrust washer and see note below.

Note: Check the prop shaft seal behind the propeller for fish line and debris that could cut prop shaft seal.

Installing propeller- Before installing parts back on to the prop shaft make sure you lubricate the prop shaft with the recommended lube.

1. Install the thrust washer on the prop shaft first as indicated in the illustration above. Then install the propeller.
2. Align the spacer protrusions with the cutouts of the propeller.
3. Install the spacer, washer, and propeller nut. Tighten the propeller nut to 40 foot pounds with a torque wrench.
4. Next, line up the protrusions on the spacer with the cut outs on the prop itself.
5. Align the propeller nut slot with the prop shaft hole.
6. Install a new cotter key and carefully bend the cotter pin ends over.

Note: Using an old cotter key increases the chances of the propeller working itself off the shaft since the cotter pin ends become stressed and weak after being bent over and constant engine vibration weakens the cotter key ends.

Note: If the prop shaft nut does not line up to insert the cotter key, tighten the nut to the point where it does line up with the prop shaft.

Battery



Frequently check your battery terminals for corrosion build-up. If you find a greenish, powdery substance, remove the cable connections and clean

both the both the terminals and the connectors with a wire brush and a paste made from baking soda to neutralize any acid. When the cleaning is finished reconnect the battery cables and coat the terminal with a dielectric grease or petroleum jelly to help prevent further corrosion.

Check the electrolyte level at least every 30 days, more often in hot weather. The level should be maintained between the top of the battery plates and the bottom of the fill cap opening.

Add distilled water as needed to flooded electrolyte batteries after charging the batteries or periodically as needed. Do not overfill because sulfuric acid could run over and cause burns or explosion.

Batteries should be charged outside the boat. Do not smoke or bring flames near a battery that is being or has recently been charged. The hydrogen gas generated by battery charging is highly explosive. Charge flooded electrolyte batteries to 13.4 volts and 13 volts for AGM batteries.

Do not allow a metal object such as a wrench or loose wires to spark across battery posts while working close to the battery. Contact across terminals will cause a short circuit and personal injury may result. Recover positive posts with red "boot".

Tighten all battery connectors securely. Check their tightness by pulling on the connectors. They should not move from their tightened position. Be sure to reinstall the positive boot over the battery terminal after tightening the battery post connection. While using the boat, use the volt meter to monitor the charge level of the battery. Monitor the charge with the engines turned off (static condition).

The engine alternators recharge the batteries. A fully charged battery will indicate between 12.3 and 12.6 volts on the voltmeter. Readings below this could indicate a dead battery cell or a charging system malfunction which should be checked by a marine professional.

 **WARNING**

AVOID SERIOUS INJURY!
BATTERIES CONTAIN SULFURIC ACID (POISON) WHICH ALSO CAN CAUSE BURNS. AVOID CONTACT WITH THE SKIN, EYES, AND CLOTHING. IF CONTACTED, FLUSH WITH WATER FOR AT LEAST 15 MINUTES. IF SWALLOWED, DRINK LARGE AMOUNTS OF WATER, OR MILK. FOLLOW UP WITH MILK OF MAGNESIA, BEATEN EGG, OR VEGETABLE OIL. GET MEDICAL ATTENTION IMMEDIATELY!

 **WARNING**

AVOID SERIOUS INJURY!
WEAR GOGGLES, RUBBER GLOVES, AND A PROTECTIVE APRON WHEN WORKING WITH A BATTERY. BATTERY ELECTROLYTE CAUSES SEVERE EYE DAMAGE AND SKIN BURNS. IN CASE OF SPILLAGE, WASH AREA WITH A SOLUTION OF BAKING SODA AND WATER.

Remote Control



Check the helm control box and make sure there is no roughness or tightness when shifting. Also, check to make sure the control box hardware is tightly secured. The

shifting is done by a process called “fly by wire” Being the engines use electronics to shift it should be effortless. An application of silicone spray on the handles will help fight any corrosion. Remember there are no actual mechanical shift and throttle control cables on your vessel. There is a friction control which may be altered to personal needs. Contact your closest Regal outboard dealer for further assistance or a marine professional.

Seating

Care of your seating includes periodic cleaning with products which are non-corrosive and are recommended for vinyl. Select seats use rams and hardware which needs to be periodically checked for tightness. See the cleaning vinyl for more information.

Periodically check all seat hardware to ensure a good working condition and make sure all moving parts are properly lubricated and all fasteners are tightened properly.

Fuel System

At least annually inspect all fuel system components for loose clamps at the vent, fill and feed locations. Examine each hose for signs of deterioration and leakage. Check the fuel sender for loose bolts, nuts, and leaks at all areas of contact. Also, inspect the fuel tank for signs of leakage or abrasion. Tighten all components as needed.

 **WARNING**

AVOID SERIOUS INJURY OR DEATH DUE TO
FIRE OR EXPLOSION RESULTING FROM
LEAKING FUEL!
INSPECT ENTIRE FUEL SYSTEM
AT LEAST ONCE PER YEAR.

Stereo

The Fusion® stereo head unit requires little maintenance. When washing the cockpit, do not discharge water directly at the stereo unit. Possible damage may result. As with any CD unit clean your CD's to keep them from skipping. This process also aids in keeping dust out of the unit. For further information, refer to your stereo owner's manual located in the owner's packet.

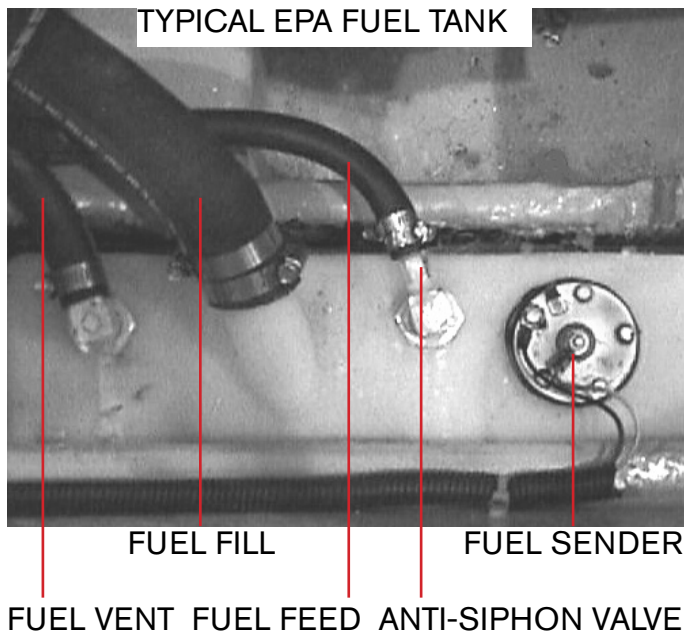

Galvanic Corrosion/Stray Current

Metal parts underwater can be subjected to two basic styles of electrolysis: galvanic corrosion and stray current corrosion. Both can damage the drive, propeller, underwater parts, boat and motor if not correctly monitored (testing at 2 week intervals) and avoided.

Galvanic corrosion is an electrochemical reaction between two or more metals. Drive systems consist of several different metals. Some are more active than others.

Galvanic corrosion of the more chemically active metals can occur whenever two or more dissimilar metals that are “grounded” (connected by actually touching each other, or through a wire or metal part) are immersed in a conductive solution (any material that can conduct electricity). Anything but pure water is conductive. Saltwater, fresh water with a high mineral content and polluted freshwater are highly conductive. Conductivity increases with temperature. That is why Florida boats experience more corrosion than boats in Maine.

Specifically look at a typical marine drive unit with a stainless steel propeller. The aluminum is the more chemically active metal (called the anode) and the stainless steel propeller is the less chemically active metal (called the cathode).

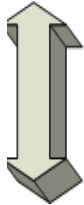
CORROSION TABLE	
Gold	 <p>Least Active</p> <p>Most Active</p>
Stainless Steel	
Bronze	
Copper	
Brass	
Steel	
Aluminum	
Zinc	
Magnesium	

Typically electrons flow from the anode (the aluminum drive unit), via the external conducting path to the cathode (stainless steel propeller). If there is a very large anode connected to a small cathode, the anode will corrode very slowly. If a very large cathode is connected to a small anode, the anode will corrode very quickly. Obviously, if you do not control galvanic corrosion, over time the aluminum will corrode away.

The first sign of galvanic corrosion is paint blistering (starting on sharp edges) below the water line; a white powdery substance forms on the exposed metal areas. As the corrosion advances, the exposed metal will become deeply pitted as the metal is actually eaten away.

Another condition which will increase galvanic corrosion is the removal or reduction in surface area of the sacrificial anodes. Never add aftermarket products that are connected to the engine ground such as stainless steel steering aids and trim planes. Zinc connected to aluminum will form a corrosion cell but the aluminum (drive) becomes the cathode and the zinc (anode) corrodes.

Even though your boat may not have shore power aboard current from nearby vessels with shore power can produce stray current galvanic corrosion. Stray current corrosion occurs when metal with an electrical current flowing into it is immersed in water that is grounded (lake, ocean, pond). The current can leave the metal and flow through the water to ground. This will cause rapid corrosion of the metal at the point where the current leaves.

When a vessel nearby is plugged into shore power, they can potentially tie your outboard drive unit to their boat via the green grounding shore power lead. Your outboard drive unit could be the receiving end of a large galvanic cell (a battery) interconnected with nearby vessels or even through the marina's metal structures via their electrical system.

The vessel should be tested every couple of weeks to determine the integrity of the anode protection system. Another way to test the system is to measure the hull potential. This is accomplished by immersing a reference electrode, usually a silver/silver chloride into the water about six inches behind the drive. With leads attached to a digital multimeter the hull potential is read on the DC scale and compared to recommended specifications for the water body type. See the owner's information vendor packet for more information or contact your nearest authorized Regal dealer.

Tips To Aid In Maintaining Galvanic Integrity

1. Test the galvanic integrity of your vessel every 2 weeks. Raise the drive and inspect anodes/parts for signs of galvanic corrosion, stray current corrosion or loose fasteners. Contact your closest Regal dealer/marine professional where signs of galvanic corrosion exist.
2. Never paint over anodes as they will become inoperative. Always leave at least one inch between bottom paint and any underwater fitting such as sea cocks, swim platform stanchions and all drive and propulsion related underwater parts.

3. Periodically remove vessel from water and clean/pressure wash all outboard, anode and hull bottom areas to remove growth.

4. Ensure vessel is using the correct anode metal for the body of water that it is moored. See the outboard engine manufacturer's manual for more information or contact an authorized dealer.

5. Ensure that the drive is completely "in" down to provide more complete anode protection when vessel is moored.

6. Do not attempt to use magnesium anodes in saltwater. They will provide over protection.

7. If marina moored, contact appropriate personnel if signs of galvanic corrosion appear on your drive system. Ask them to check for stray electrical current which may be originating from a nearby vessel's faulty DC wiring or from a marina pier, piling or dock carrying leaking marina ground wiring such as a dock side cord partially submerged.

GALVANIC/STRAY CURRENT CORROSION	
Cause/Observed Condition	Corrective Action
Sacrificial anodes consumed	Replace anodes when 30% consumed
Sacrificial anodes not grounded to drive	Remove anodes, clean contact surface, reinstall, check for continuity
Loss of continuity between underwater parts & ground	Provide good ground connections
Nearby vessel with stray current	Contact appropriate personnel Remove your vessel from water
Paint on drive heavily worn, exposing more metal	Prime and repaint or install additional anodes
Sacrificial anodes painted	Remove paint or replace anodes
Drive tilted/anodes out of water	Leave drive down, install additional anodes below water
Power trim cylinders only corroded	Provide a good ground to drive, all parts must be grounded
Corrosion in area of exhaust outlets	Remove deposits
Corrosion occurring after vessel is removed from saltwater	Wash exterior and flush interior with freshwater
Stainless steel parts corroding	Clean parts, remove foreign material, ensure continuity
Underwater drive parts corroded, sacrificial anodes OK	Oxide film on anode (fresh water only) Replace anode Poor ground. Scrape anode.

Zinc Anodes



Sacrificial zinc anodes are located on the outboard drive housing, trim cylinders and/or prop shaft to protect softer metals exposed to the water. The anode shown doubles as a steering device called a trim tab that is used to remove steering torque at cruising speeds. Electrolysis attacks the least noble metals first. Because zinc is a less noble metal, it will decompose before other metals. Check these zinc anodes periodically and have them replaced when they are 30% consumed. Notwithstanding, zinc is the most popular metal used to protect parts that are exposed to saltwater, freshwater or brackish water.

Note to never paint an anode as it destroys its ability to fight electrolysis.

Zinc anodes in brackish or salt water need to be checked more frequently. If the anodes seem to be requiring frequent replacement there may be a boat leaking DC current into the water taxing the anodes. This is especially possible around a marina environment. Contact a marine professional who can measure the galvanic activity with a special electrode and VOA meter. Refer to the engine manufacturer's manual for exact anode location and more detailed information.

Inspect any attached ground leads for tightness.

Note that parts damage due to galvanic or stray current corrosion is not covered under warranty.

Outboard Engine Maintenance

A select portion of maintenance items are covered in this chapter. Since advanced ignition and fuel injection systems are used on outboard engines along with special factory training and tools it is best to contact your Regal dealer for more of the detailed outboard service procedures.



CAUTION

AVOID ENGINE DAMAGE!
FOLLOW ALL BREAK-IN PROCEDURES RECOMMENDED BY THE ENGINE MANUFACTURER. FAILURE TO FOLLOW BREAK-IN PROCEDURES MAY VOID THE OUTBOARD ENGINE WARRANTY.



CAUTION

AVOID ENGINE DAMAGE!
DO NOT RUN OUTBOARD ENGINE AT A CONSTANT RPM FOR PROLONGED PERIODS OF TIME DURING BREAK-IN PERIOD. CHECK ENGINE OIL OFTEN.



CAUTION

AVOID ENGINE DAMAGE!
DO NOT RUN OUTBOARD ENGINE OUT OF WATER UNLESS YOU USE AN OPTIONAL FLUSHETTE. FOLLOW MANUFACTURER'S ATTACHING AND RUNNING INSTRUCTIONS!

Fuses- Electric Cover Plate

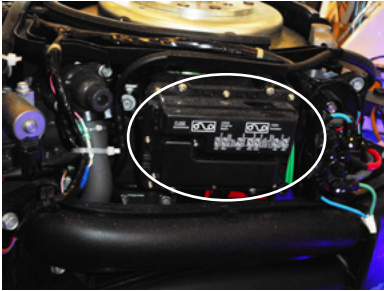

As part of Yamaha outboard electrical systems under the motor shroud (engine cover) on the side of the outboard engine is

a fuse cover plate. Under this cover is a variety of fuses protecting various engine components. The components include the fuel pump, electronic control module, main fuse, starting switch, shift actuator, ignition coil, fuel injector and variable camshaft timing.

There are also extra fuses stored along with a fuse puller. In most cases remove the old fuse with the fuse holder. Install a replacement fuse of the same type and amperage.

For further information, refer to the manufacturer's outboard engine manual.

Checking Fuel System Water Separator Filter



Periodically check the fuel filters. A 10 micron in-line water separator filter for each engine is installed in the aft bilge in both stern drive and outboard systems. Use an oil spanner type wrench and turn

the filter counterclockwise to remove the element.

Empty the contents into a clean pan and view the contents. Water in fuel tends to hug the bottom and will show a different color than the fuel. At least yearly or on an as needed basis replace the filter element. Fill the element up with fresh unleaded fuel of the correct octane rating and turn it clockwise until tight. Finish tightening with the spanner wrench. Wipe any excess fuel with a clean towel and dispose of in an environmentally friendly manner. Never store fuel soaked rags on board. As always run the blowers for at least 4 minutes and check for leaks before starting the engine.

It is a great idea to keep extra filter elements on board in protective wrap for emergency use.

Mark the replacement date on the fuel filter as a reminder to periodically change the unit.

Checking Engine Mounted Fuel Filter

As part of select outboards under the motor shroud (engine cover) on the lower front side of the outboard engine is a fuel filter. Periodically check to ensure the fuel filter is clean and free of water. When reinstalling the filter tighten to manufacturer's specifications. Check for leaks after starting the engine. Remove the cover shown in the photo below to access the fuel filter. For more information refer to the outboard manufacturer's operator's manual or contact a Regal dealer or marine professional.

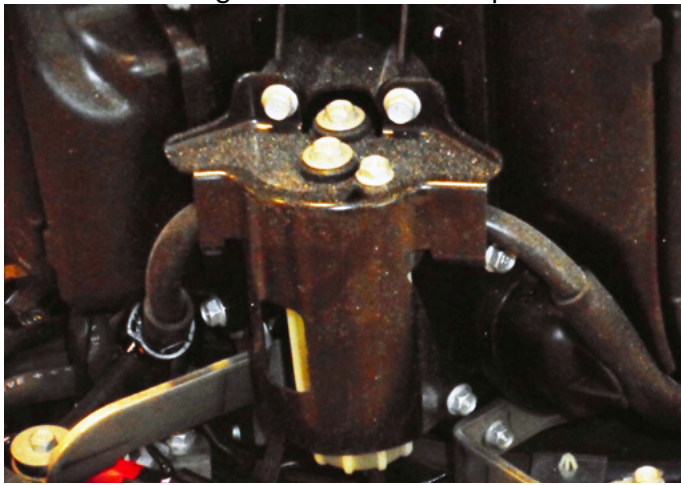

Flushing Device

Your Yamaha outboard features a flushing device which when connected to a garden hose circulates fresh water through the engine to purge unwanted debris such as found in salty, brackish, and silty water.

To use open the flushing device by turning it counterclockwise. Notice there is a garden hose bib thread. Attach the male end of a garden hose to the fitting and tighten it. Make sure the fitting does not leak as the power head could overheat and cause internal damage. It is best to perform this flushing procedure with the engine still warm from a cruise as the thermostat will be open and will permit more efficient water circulation. Turn on the fresh water supply. When flushing completed remove the garden hose from the fitting and reattach the hose connections and of course check for tightness.

Note not to start engine during this procedure as overheating and engine damage may occur.

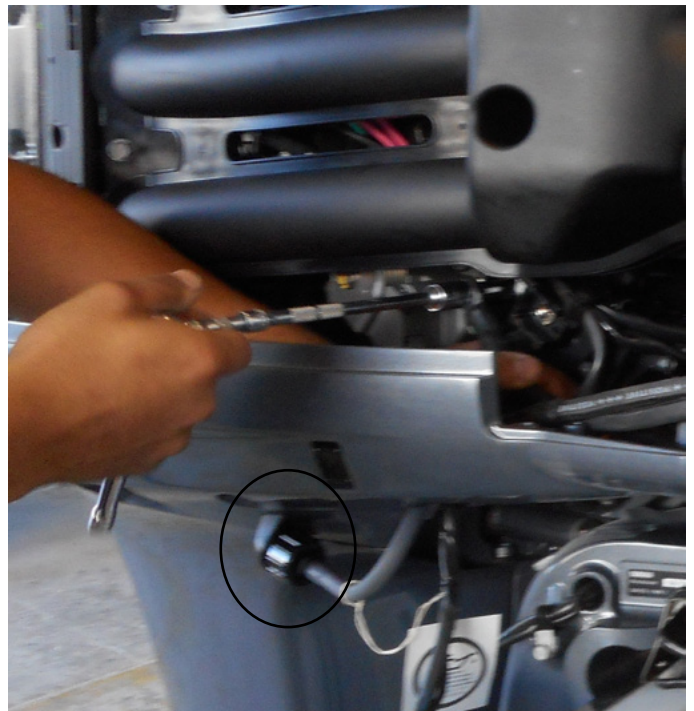

Checking Engine Crankcase Oil

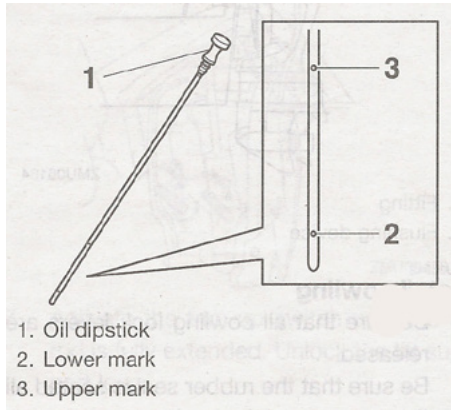

Your Yamaha outboard features 4 cycle engine operation. Unlike 2 cycle outboards which mix gas with oil

technology, the 4 cycle engine uses crankcase 4 cycle oil to lubricate internal moving parts. This operation is similar to automobile engine technology. As part of this process, there is a dipstick placed in the crankcase to offer periodic checking of engine crankcase oil.

To check the crankcase oil do the following:

1. Ensure the outboard is setting in a flat vertical position or the dipstick may not display an accurate oil level.
2. Remove the crankcase oil dipstick and wipe it clean.
3. Reinstall the crankcase oil dipstick completely into the hole. Remove it again.
4. The oil level should be between the upper and lower dipstick holes. .As needed add the manufacturer's recommended oil or contact your closest dealer especially if the oil is contaminated with water which will show a milky color verses a clear look. Refer to the outboard manufacturer's owners manual for oil changing maintenance schedules.

Checking/Filling Crankcase Oil- (Cont.)

When adding crankcase oil be sure to utilize the manufacturer's recommended type and viscosity. For changing crankcase oil contact your closest Regal dealer for additional information since they have the special tools and knowledge for these maintenance procedures.

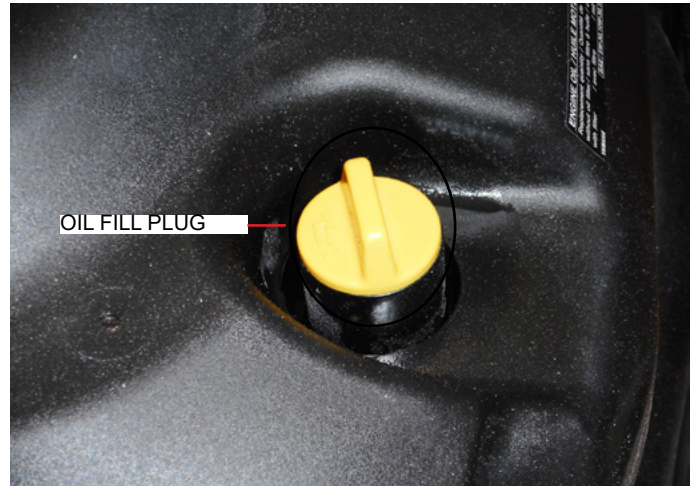

Chapter 9

Troubleshooting

The following diagnostic information will assist you in identifying minor electrical, fuel, and mechanical problems. Some of the items listed require technical training and tools. Additional assistance is available in the engine manufacturer's owner's manual. Also, you can contact your closest Regal dealer or marine professional for more information. Sometimes a problem can be solved by performing a logical sequence of elimination and/or root cause techniques.



WARNING

AVOID SERIOUS INJURY OR DEATH!
BEFORE PERFORMING ANY MAINTENANCE
WORK, TURN OFF THE BATTERY SWITCH
AND REMOVE THE IGNITION KEY(S)
FROM THE SWITCH.



WARNING

AVOID SERIOUS INJURY OR DEATH!
USE ONLY APPROVED MARINE
REPLACEMENT PARTS THAT
ARE IGNITION PROTECTED.

ENGINE DIAGNOSTIC CHART

Problem	Possible Cause
Engine Overheating	<p>Water pick-up feeds are blocked by debris</p> <p>Cooling system leak</p> <p>Impeller is worn or blocked by debris</p> <p>Propeller is over propped for the circumstances, causing the engine to work extra hard</p> <p>Debris in oil is holding heat more than normal - defective oil filter</p> <p>Defective thermostat.</p> <p>Faulty temperature sender.</p>
Starter Will Not Crank	<p>Battery weak or dead</p> <p>Starter defective</p> <p>Fuse for electric start relay blown</p> <p>Control not in neutral</p> <p>Defective start panel button</p>
Excessive Steering Play	<p>Air in steering lines (Bleed)</p> <p>System low on steering fluid</p> <p>Mechanical parts-loose connection</p>

ENGINE DIAGNOSTIC CHART

Problem	Possible Cause
No Power To Helm	Battery switch turned off Batteries are weak or dead. Main breaker tripped Loose connection
Engine Cranks But Will Not Start	Fuel flow obstructed/water in fuel Low battery voltage Engine ignition system malfunction Timing belt broken No fuel in tank Lanyard not attached Control not in neutral
Hard Starting	Vacuum In Fuel System Fuel lines obstructed Water in fuel Debris in fuel/clogged fuel filter
Engine Idles/ Runs Rough	Old fuel Faulty spark plugs Fuel contaminated/ clogged anti-siphon valve (fuel tank)

ENGINE DIAGNOSTIC CHART

Problem	Possible Cause
Power Loss	Damaged propeller Improper trim angle Spark plugs fouled Fuel system malfunction Ignition system malfunction Hull bottom fouled with debris Excess water in bilge (leak) Engine needs tune-up Low octane fuel Engine cooling system malfunction Vessel overloaded
Excessive Vibration	Damaged propeller Bent propeller shaft Bent vertical drive shaft Loose/broken motor mount Steering pivot loose or damaged Debris caught on propeller Ignition malfunction Motor mount bolts loose (transom) outboards Damaged stern drive cavitation plate Boat bottom damaged

ENGINE DIAGNOSTIC CHART

Problem	Possible Cause
Buzzer Sounds/Icon Lights	Cooling system malfunction Engine oil level low or incorrect type Wrong spark plug heat range Oil feed pump malfunction

DC ELECTRICAL SYSTEM DIAGNOSTIC CHART

Problem	Possible Cause
No 12 Volt Power At Battery	Charging system inoperative Weak or dead battery Battery cables loose/disconnected Battery cables corroded
Battery Not Charging While Engine Is Running	Faulty stator/alternator Faulty circuit wiring
Battery Will Not Hold Charge	Faulty/old battery Loose battery cables Corroded battery terminals
12 Volt Equipment Not Working	Fuse blown-Take time to investigate why the equipment was drawing too much current or why it had a short circuit. Check fuses at fuse block and under the engine shroud Weak or dead battery if all 12 volt equipment fails to function. Corroded/loose wire connection Internal equipment short /failure

AC ELECTRICAL SYSTEM DIAGNOSTIC CHART

Problem	Possible Cause
No Voltage At Main AC Panel	Ships dock side cord not plugged in Dock side breaker tripped ELCI breaker tripped Faulty dock side power cord
AC Panel Indicates Reverse Polarity	Dock side wires reversed at marina power supply.
No Voltage At GFCI outlets	GFCI outlet tripped (reset) Outlet breaker off at AC main ship's panel Unplug faulty equipment-short
Main AC Panel Breakers Trip When All Equipment Is Energized	Turn off equipment as needed to balance load on shore 1 and shore 2

Chapter 10

Storage & Winterization

Storage procedures are outlined in this chapter. These are general guidelines to follow before longer periods such as over the winter in colder climates. Be sure to familiarize yourself with all relevant information in the owner's sacht.

Special winterization procedures are necessary for the boat, components and systems. Use the enclosed checklists to help you identify areas of concern and maintenance.

Contact an authorized Regal dealer or marine professional for further information regarding storage/maintenance procedures. Also, more specific information can be found in the engine manufacturers operation manual.

Note that all recommendations and instructions may not apply to your particular model.



WARNING

AVOID SERIOUS INJURY OR DEATH
DUE TO FIRE AND EXPLOSION!
DO NOT FILL FUEL TANK TO RATED
CAPACITY. LEAVE ROOM FOR EXPANSION.

NOTICE

REMOVE BATTERIES WHEN VESSEL
IS IN LONG PERIODS OF STORAGE
ESPECIALLY IN COLD CLIMATES
BATTERIES CAN FREEZE AND POSSIBLY
LOSE ELECTROLYTE.

NOTICE

AVOID SERIOUS ENGINE DAMAGE! USE
ONLY FACTORY APPROVED PRODUCTS
FOR ENGINE AND DRIVE DURING STORAGE
PERIODS.

NOTICE

AVOID HULL BOTTOM DAMAGE!
NEVER BLOCK UP THE BOAT BOTTOM AS
DAMAGE TO THE HULL MAY RESULT AND IS
NOT COVERED BY REGAL WARRANTY.

Decommissioning Checklist

Engine Winterization/Maintenance

- Run engine. Pour approved fuel stabilizer/conditioner in the fuel tank. Allow time for it to circulate through the fuel system.
- Change all engine fluids as referenced in the engine manufacturer's owners manual. Contact a Regal dealer.

With Volvo stern drive power where called for make sure to drain the engine per the Volvo "easy drain" owners manual instructions. Contact closest authorized Volvo or Regal yacht dealer for further information.

- Check engine hoses, clamps, and system wiring for loose connections, abrasion, and corrosion.
- Spray all exterior parts with a rust preventative.
- Perform maintenance as referenced in the engine manufacturer's owners manual. Contact your Regal dealer.
- Remove propellers. Refurbish as needed.
- After cleaning use touch up paint on drive unit as needed.
- Apply coat of wax to exterior drive parts.

Boat

- Check hull bottom for any fiberglass damage.
- After cleaning apply a coat of wax to hull and deck surfaces.
- Remove batteries. Use a trickle charger as needed.
- Remove all loose gear and electronics from boat. Inspect all equipment for wear and damage. Store in a clean, dry environment.
- Remove drain plug. Clean drain plug hole of debris as needed. Enclose drain plug in plastic bag and tie to steering wheel.
- Make sure bow is higher than stern to permit proper drainage.
- Clean all upholstery and store so it breathes.
- Conduct a visual inspection to ensure boat is balanced properly on the trailer, cradle or blocks.
- Cover boat with appropriate cover. Tie down for protection from rain, snow and/or wind. Prop up cover to provide proper ventilation. Do not cover up the fuel vents.
- Drain the fresh water system per instructions in this chapter.
- Use sling locations for lifting boat via technical section drawing.
- Pour a pint of 50/50 antifreeze into bilge pump.

NOTICE

NEVER BLOCK UP BOAT HULL BOTTOM!
MAY CAUSE STRUCTURAL DAMAGE
TO THE HULL.
STORE ON AN APPROVED CRADLE
OR TRAILER
THAT ADEQUATELY SUPPORTS THE HULL.
DAMAGE CAUSED BY BLOCKING HULL
BOTTOM IS NOT COVERED
BY REGAL WARRANTY.

Trailer

- Repack all wheel bearings per trailer manufacturer's specifications.
- Check all trailer parts for excessive wear. Replace/ refurbish as needed.
- Use touch up paint on trailer as needed.
- Use a rust preventative on springs and axle parts as needed.
- Check all lighting for proper operation.
- Check brake pads, rotors, and/or drums for wear.
- Drain and refill brake system with proper fluid as needed per trailer manufacturer maintenance specifications.

Typical Fresh Water System With Deck Fill Cap

1. Activate the fresh water pump switch.
2. Open all faucets including transom shower (if equipped) and allow tank to empty.
3. Drain the water tank. Shut off fresh water pump switch.
4. Mix **nontoxic antifreeze** with water in accordance with the manufacturer's recommendations. (Available at marina & RV stores)
5. Put solution into the fresh water tank
6. Turn on fresh water pump switch.
7. Open water faucet and purge until a steady stream of **nontoxic antifreeze** flows from the faucet. If equipped, do the same to the transom shower. Turn the fresh water switch to the "off" position.

Waste System

1. With chemical heads, make sure to dump both upper and lower tanks. Rinse well with fresh water. Sanitize chemical head as needed.
2. With electric head, pump out holding tank. Add nontoxic antifreeze to toilet and holding tank. Pump from toilet to holding tank to eliminate any water remaining in supply lines.

NOTICE

AVOID VESSEL AND/OR OUTBOARD ENGINE DAMAGE! CONTACT A MARINE PROFESSIONAL FOR WINTERIZATION ASSISTANCE. DAMAGE CAUSED BY IMPROPER WINTERIZATION IS NOT COVERED BY THE VESSEL OR ENGINE MANUFACTURER.



DANGER

AVOID BODILY INJURY OR DEATH DUE TO POISON! NEVER USE AUTOMOTIVE TYPE ANTIFREEZE IN A WATER SYSTEM SINCE IT IS POISONOUS TO THE HUMAN BODY!

Adding Freeze Ban/Disinfectant Using Vent Line

On vessels with integrated water fill systems rather than the deck fitting (without a deck fill plate), it is recommended to remove the vent hose and adding non-toxic antifreeze/disinfectant through the vent barb. It is easier to add either of the products above to the tank. Connect a short section of 5/8" hose to the vent fitting to make pouring the product using a funnel.



Adding Freeze Ban/Disinfectant Using Dockside Water Fitting

On vessels with integrated water fill systems rather than the deck fitting (without a deck fill plate), it is recommended to use the dockside water fill fitting (city water valve) on the stern of the boat for adding disinfectant or **anti-toxic antifreeze**. The suction line goes to the fluid to be filled and the pressure line screws (hose bib male fitting) into the dockside water inlet.

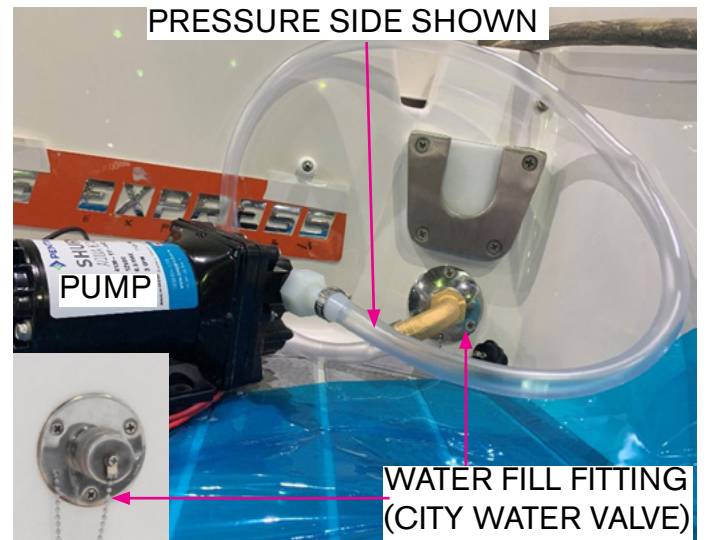

 **DANGER**

AVOID BODILY INJURY OR DEATH DUE TO POISON! NEVER USE AUTOMOTIVE TYPE ANTIFREEZE IN A WATER SYSTEM SINCE IT IS POISONOUS TO THE HUMAN BODY!

 **DANGER**

AVOID BODILY INJURY OR DEATH DUE TO POISON! NEVER USE AUTOMOTIVE TYPE ANTIFREEZE IN A WATER SYSTEM SINCE IT IS POISONOUS TO THE HUMAN BODY!

Recommissioning Checklist

Engine

- Check all components per engine manufacturer's owner's manual especially fluid levels.
- Run engine on "ear muffs" (flushette) before launching. Check for fuel, exhaust, oil, and water leaks.

Boat

- Install drain plug.
- Install battery and tighten all terminals.
- Check all equipment, switches, alarms, gauges and breakers for proper operation.
- Add necessary chemicals and water to chemical head.
- Add water to fresh water tank. Turn on faucet to purge tank. Refill water tank.
- Make sure all safety gear is on board and in excellent working condition.
- After launching, check controls, gauges and systems for proper operation.

Trailer

- Make sure all equipment is in excellent working condition.

Chapter 11

Glossary & Index

Below is a brief list of nautical terminology. For more detailed glossaries we recommend you check your local library, book retailer, marine store or internet.

Glossary

Abeam: at right angles to the fore and aft line and off the boat

Aboard: on or in the boat

Above: the part of the boat on a vessel which is above the interior of the boat

Aft, After: aft is the boat section toward the stern or back of the boat

Amidships: toward the center of the boat from either side to side or rear to front

Beam: the width of a boat at its widest part

Bilge: the lower interior of the hull of the boat

Bitter end: the end of a line also the end of an anchor line

Bow: the front, or forward part of the boat

Bulkhead: the vertical partition or wall of a boat

Cast off: to let go or release

Chine: the line fore and aft formed by the intersection of the side and bottom of the boat

Chock: deck fitting used to secure or guide anchor or tie lines

Cleat: deck fitting with protruding arms around which lines are secured

Cockpit: the seating space used to accommodate passengers

Cuddy: a small cabin in the fore part of the boat

Deck: the open flooring surface on which crew and passengers walk

Draft: the depth from the waterline of the boat to the lowest part of the boat, which indicates how much water is required to float the boat

FasTrac: a proven hull bottom design which incorporates a full, mid-beam step that reduces drag by forcing air under the hull to decrease drag and friction.

Fathom: a measurement of depth; one fathom equals six feet

Fender: a cushion hung from the side of a boat to prevent it from rubbing against a dock or against other boats.

Fend off: to push off to avoid sharp contact with dock or other vessel

Fore: the part of the boat toward the bow or front

Freeboard: the height of the top side from the waterline to the deck at its shortest point (The distance from sheer or gunwale to the water).

Gunwale: rail or upper edge of the side of the boat

Head: toilet

Hull: the part of the hull from the deck down

Keel: the lowest point of a boat; the backbone of the vessel

Knots: a measurement of speed indicating nautical miles per hour

Lee: the side opposite that from which the wind is blowing; the side sheltered from the wind

Leeward: the direction toward which the wind is blowing

PFD: personal flotation device; required for each person aboard

Port: the left side of the boat when facing forward (an easy way to remember the difference between "port" and "starboard" is that both "port" and "left" have four letters)

Shank: the main body of an anchor

Sheer: the curve of the boat's deck from fore to aft when seen from the side

Starboard: the right side of the boat when facing forward

Stern: the aft end of the boat

Stern drive: an inboard/outboard (I/O) unit

Stringer: strengthening integral unit fastened from fore to aft inside the hull and fiberglass encapsulated for added strength: much like the skeleton system of our body

Index

A		C	
Accidents	38	California EVAP Regulation	2
Accident Reporting	38	California Spark Ignition Warranty Info	2
Acrylics	271	Canvas	236
Anchor Light	30		274
Anchor Windlass	229	Carbon Monoxide	34
Anchoring	224	Cardiopulmonary Resuscitation	227
Audible Alarms	156	Caution Labels	19
Automatic Fire Extinguisher	53	Cockpit Sea Grass Mat	240
		Controls	153
			170
			199
B		D	
Battery	76	Danger Labels	19
	278	Dealer Responsibilities	13
Battery Charger	89	Decommissioning	296
Battery Management System- Earlier	78	Diesel Engine Troubleshooting	214
Battery Management System- Stern Drive	81	Direct Current Protection	56
Battery Management System- Outboard	85	Distress Signals	28
Battery Switch-Automatic Remote Type	174	Diver's Flag	40
Bilge Pump	233	Docking	218
Boating Under The Influence	37	Drain Plug	215
Bottom Blocking	295		
Bow Thruster	234	E	
Bridge Clearance	49	EPIRB	12
Buoys & Mark	48	Electrical	34
		Emergencies	226
		Engine Basics-Diesel Stern Drive	199
		Engine Basics-Gas Stern Drive	153
		Engine Basics-Outboard	170
		Engine- Starting Outboard	184
		Engine- Starting Gas Stern Drive- Earlier	154
		Engine- Starting Gas Stern Drive- Later	184
		Environmental Awareness	228
		Exhaust	34

F		I	
Fenders	219	Ignition Panel/Switch	184
Fiberglass	272	Index	303
Filters	285	Interior Fabrics	272
Fire Extinguishers	25	Interrupter Switch	191
	53		
First Aid	227	K	
Fishing	40	Knots	226
Fittings-Thru Hull	140		
Float Plan	10	L	
Fueling	216	Labels-Safety	19
Fuel System- EPA	122	Ladder	262
Fuses (DC)	72	Lanyard-Safety	191
		Law Of Salvage	225
G		Life Raft	33
GFCI	103	Loading	20
Galvanic Corrosion	281		21
Galvanic Isolator	106	M	
Garbage Placard	32	Maneuvering	219
Gelcoat Maintenance	272	Maintaining PFD'S	25
General Boating Safety	20	Masthead Light	30
Getting Underway	215	Metal Cleaning	176
Glossary	301	Minimum Required Equipment	33
Grill	237		
H			
Helm Controls	165		
	181		
HIN	8		
Horn	29		
	60		
Hull Bottom	276		
	295		
Hypothermia	227		

N		S	
Navigational Aids	46	Safety Labels	18
Navigation Lights	29	SeaDek	250
Navigation Rules	44	Seating	21
Notice Labels	19	Shallow Water Operation	224
Night Running	49	Shifting-Remote Control	167
			186
O		Signals-Navigation	43
Oil Spills	31	Sound Producing Devices	29
Overloading	21	Spring Line	218
		Stopping	221
Owner's Information Packet	8	Stern Line	217
Owner's Registration	13	Stereo	146
Owner's Responsibilities	13	Sun Lounge	255
		Swim Platform	261
P		Table	263
Personal Flotation Devices	23		
Plastics	270	T	
Pollution Regulations	31	Table Of Contents	5
Power Trim	141	Technical	307
	187	Toilet	133
	222	Towing	212
Pre-departure questionnaire	215	Trim Angle	210
Propellers	180	Trim Indicators	142
	277	Trim Tabs	141
		Troubleshooting	288
R		U	
Radio Communications	29	Underwater Lighting	267
Recommissioning	300	Upholstery	270
Remote Stereo Control	147		
Required Safety Equipment	23		
Right Of Way	45		
Rules Of The Road	42		

V	
Ventilation	145
Visual Distress Signals	27
W	
Water Sports	40
Warning Labels	19
Warranty	15
Weather	41
Windshield Wiper	269
Winterizing	295
Wiring Color Codes	73
Y	
Yacht Plate	8
Z	
Zinc Anodes	284

Chapter 12

Technical

Notice

The following technical information and drawings can be an aid in troubleshooting electrical and mechanical problems along with the charts located in the troubleshooting chapter.

Note that all product specifications, models, standard and optional equipment including locations, systems, along with technical information is subject to change without notice.

For more information contact your nearest authorized Regal dealer. For the location of your nearest authorized dealer call 407-851-4360 or visit the web-site at www.Regalboats.com.

Your Regal dealer has received special factory training on the entire product line and his services should be employed to solve technical problems.

NOTE FOR DRAWING USE, 38GC (VJ) REFERS TO THE GRAND COUPE GAS/DIESEL STERN DRIVE VESSEL AND 38XO (VK) REFERS TO THE OUTBOARD VESSEL.

TYPICAL DOMESTIC COMPLIANT FUEL SYSTEM

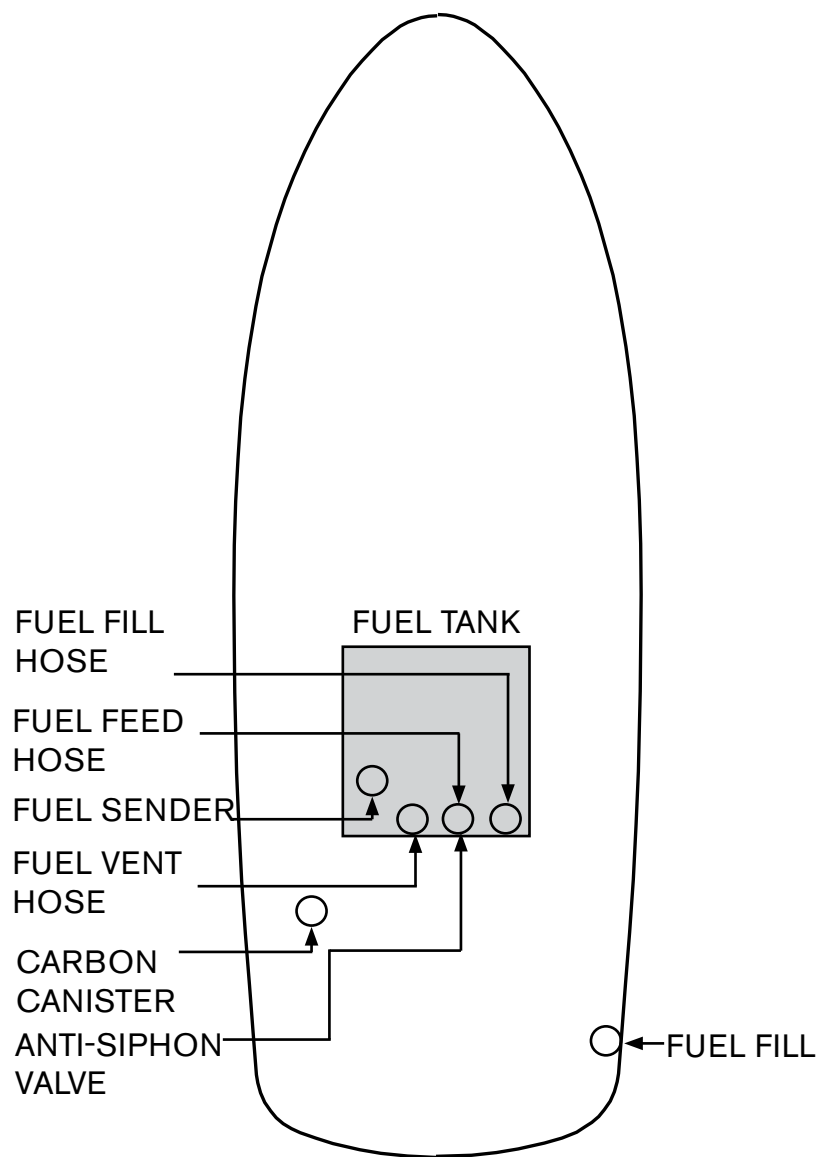

Note on the above drawing outboards use 3 fuel feed connections; gas & diesel stern drives use 2 feed connections, diesels also incorporate a return fitting for each engine. One additional fuel feed used for gas generator.

TYPICAL LABELS & LOCATIONS

WARNING
USE PROPER BLOCKING TECHNIQUES
WHEN LIFTING BOAT

NOTICE
Retrieval of Windlass Chain
Winch operator may be required
to periodically spread chain out
within anchor locker



WARNING
AVOID SERIOUS INJURY OR DEATH
FROM FIRE OR EXPLOSION
RESULTING FROM LEAKING FUEL.
INSPECT SYSTEM FOR LEAKS AT
LEAST ONCE A YEAR.

WARNING
ROTATING PROPELLER(S) MAY CAUSE
SERIOUS INJURY OR DEATH!
DO NOT APPROACH OR USE LADDER
WHEN ENGINE IS RUNNING.

WARNING
Electrical shock and fire hazard. Failure
to follow these instructions may result in
injury or death.

- Turn off the boat's shore power
connection switch before connecting or
disconnecting the shore power cable.
- Connect the shore power cable to the
boat first.
- If polarity-warning indicator is
activated, immediately disconnect cable.
- Disconnect shore power cable at shore
outlet first.
- Close shore power inlet cover tightly.

**DO NOT ALTER SHORE
POWER CABLE CONNECTORS**

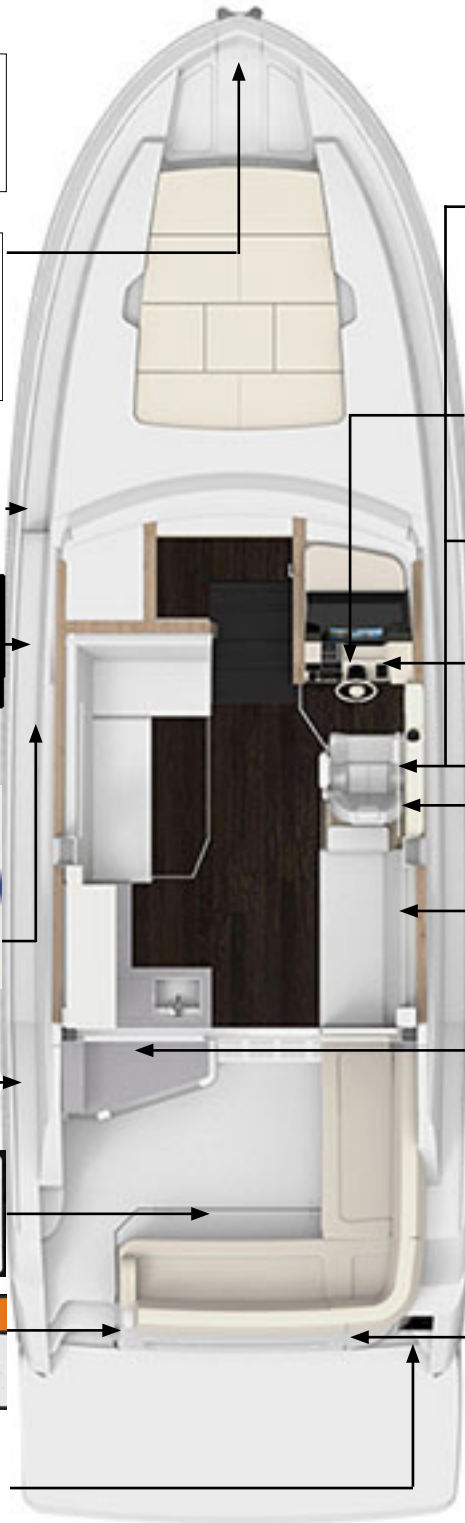

WARNING
ROTATING PROPELLER MAY CAUSE
SERIOUS INJURY OR DEATH.
SHUT OFF ENGINE WHEN
NEAR PERSONS IN THE WATER.
NW-207-08

WARNING
Carbon monoxide (CO) can cause brain damage or death.
Engine and generator exhaust contains odorless and colorless carbon monoxide gas.
Signs of carbon monoxide poisoning include nausea, headache, dizziness, drowsiness,
and lack of consciousness.
Get fresh air if anyone shows signs of carbon monoxide poisoning.
See Owner's Manual for information regarding carbon monoxide poisoning.

WARNING
GASOLINE VAPORS CAN EXPLODE BEFORE STARTING
ENGINE. OPERATE BLOWER 4 MIN. AND CHECK ENGINE
COMPARTMENT FOR GASOLINE LEAKS OR VAPORS. RUN
BLOWER BELOW CRUISING SPEED.

MEETS U.S. EPA EVAP
STANDARDS USING
CERTIFIED COMPONENTS
REGAL MARINE INC., ORLANDO, FL

REGALBOATS.COM/OWNER

WARNING
AVOID PERSONAL INJURY!
INTERRUPT SWITCH MUST BE ATTACHED TO OPERATOR
WHILE ENGINE IS RUNNING. QUALIFIED OPERATOR MUST
BE IN CONTROL AT ALL TIMES.
READ OWNER'S MANUAL BEFORE USE.

WARNING
CARBON MONOXIDE IS A TASTELESS, ODORLESS, AND
INVISIBLE GAS THAT CAN CAUSE DISCOMFORT, SEVERE
AND EVEN DEATH. EXERCISE CAUTION WHILE OPERATING
A GENERATOR OR ENGINE IN CONFINED SPACES OR AT
DOCK SIDE. DO NOT ALLOW HULL EXHAUST OUTLETS TO
BECOME BLOCKED OR EXHAUST FUMES CAN BECOME
TRAPPED IN OR AROUND THE CONFINES OF YOUR VESSEL.

THE DISCHARGE OF ALL FORMS OF PLASTIC INTO ALL WATERS IS PROHIBITED

THE DISCHARGE OF ALL GARBAGE IS PROHIBITED
into the navigable waters of the United States, and into all other waters except as specifically allowed.

ALLOWED: 3 to 12 nautical miles from land – Food waste ground to pass through a one-inch
mesh screen.

ALLOWED: 12 or more nautical miles from land – Food waste ground as above, and waste
water, and cleaning agents, en route as far from shore as practicable, that are not
harmful to the marine environment.

MARPOL ANNEX V – SPECIAL AREAS

GULF OF MEXICO & CARIBBEAN SEA – Food waste en route ground to pass through a
one-inch mesh screen.

WESTERN CARIBBEAN REGION – Discharge of all garbage prohibited within 12 nautical miles
of land.

Any person who violates the above requirements is liable for civil and/or criminal penalties and
regional, state and local restrictions on garbage discharges may also apply.

REPORT ILLEGAL DISPOSAL TO THE U.S. COAST GUARD ON VHF RADIO CHANNEL 16

DANGER
Carbon monoxide (CO) can cause brain damage
or death.
Engine and generator exhaust contains odorless
and colorless carbon monoxide gas.
Carbon monoxide will be around the back of the
boat when engines or generators are running.
Move to fresh air, if you feel nausea, headache,
dizziness, or drowsiness.

Note on the above drawing that label locations and actual label information varies by model and can change at any time.

Notice

THE DRAWINGS FOLLOWING IN THIS SECTION ARE GENERALLY COMMON TO BOTH THE 38GC STERN DRIVE AND 38XO OUTBOARD VESSELS.

38GC & 38XO 120/240 VOLT AC MASTER PANEL

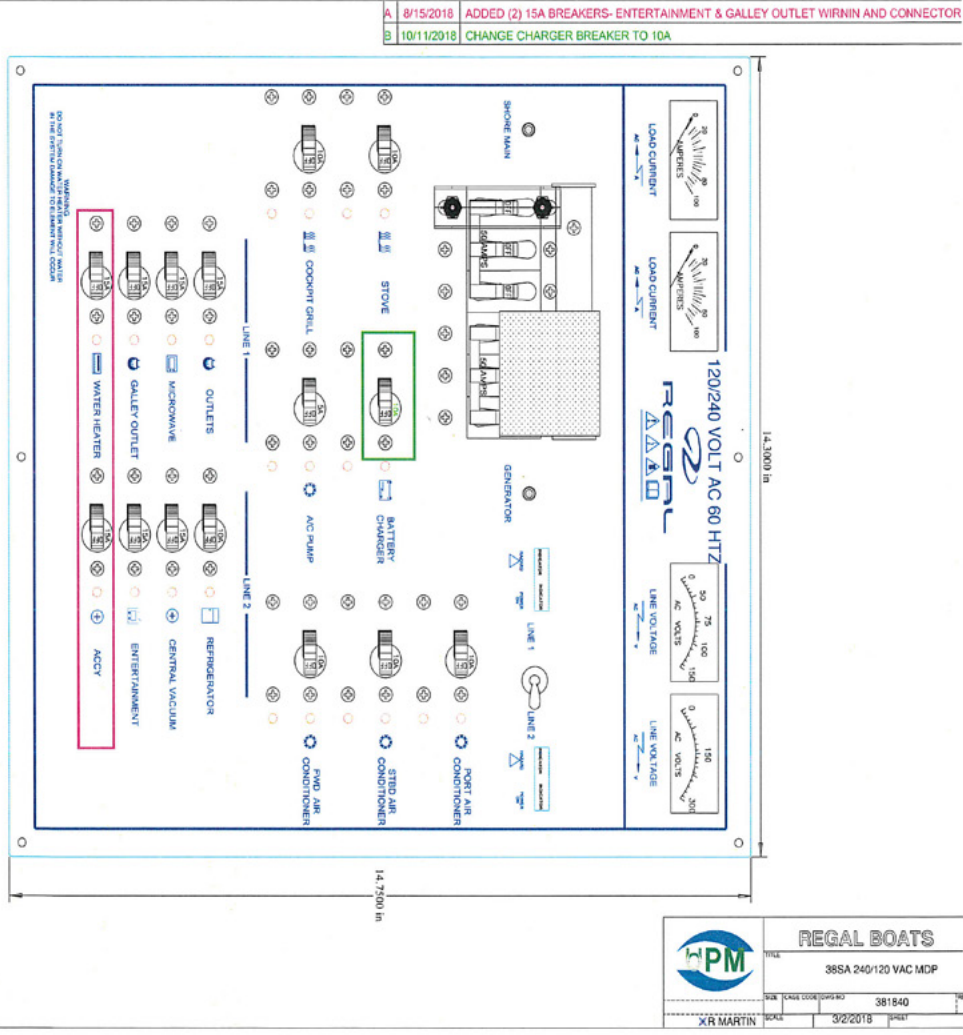

	REGAL BOATS		
	TITLE	38SA 240/120 VAC MDP	
	NO. 381540		
X R MARTIN	DATE	3/2/2018	BY

38GC & 38XO 12 VOLT DC MASTER PANEL

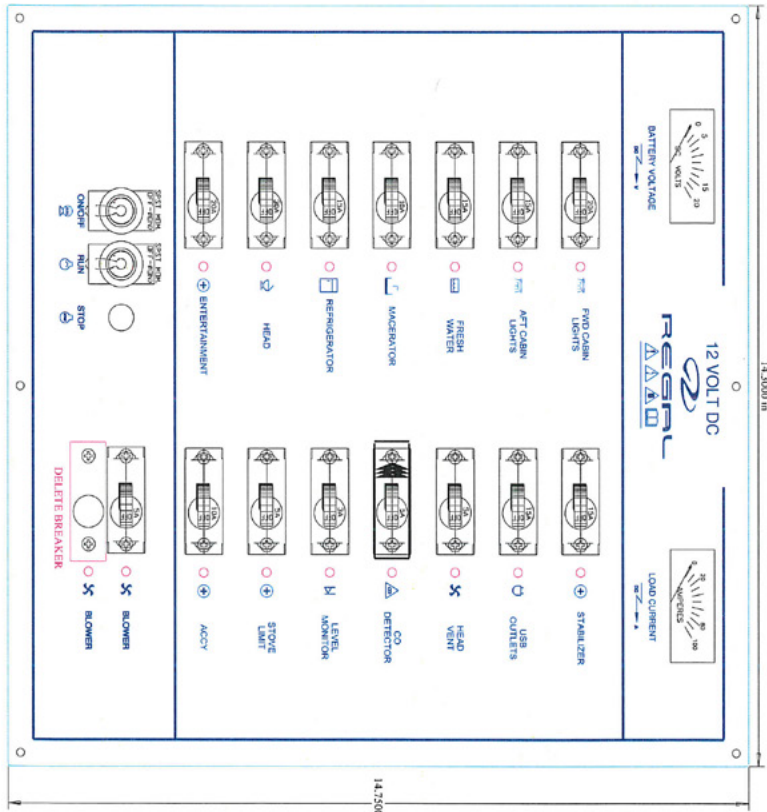

14	38GC/38XO 12VOLT DC MASTER PANEL

	REGAL BOATS	
	TITLE	38SA 12 VDC MDP
DESIGNER	381841	DATE
SCALE	3/15/2018	BY
FOR MARTIN		

38GC & 38XO 12 VOLT DC MASTER PANEL-REAR

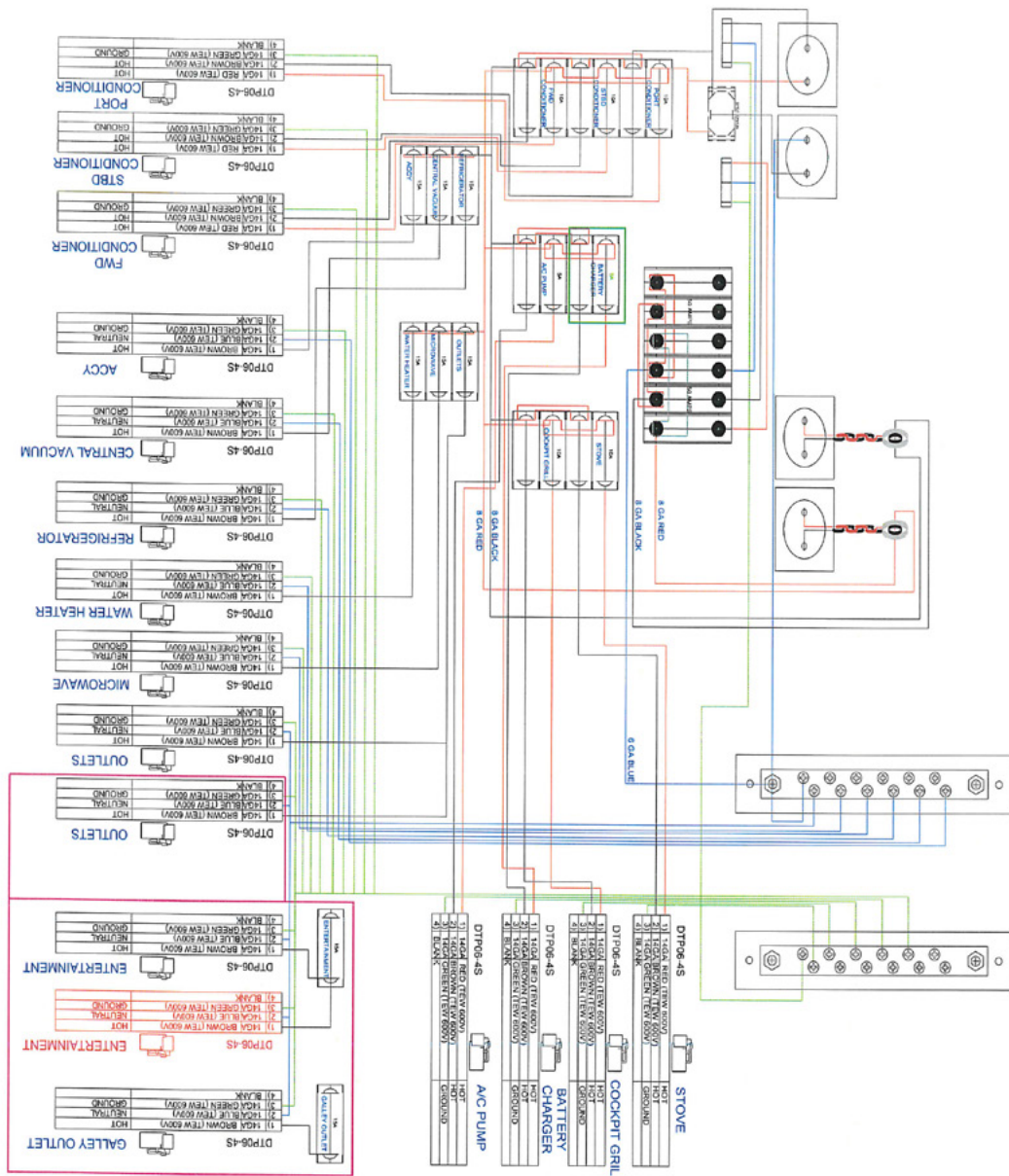

- B BATTERY
- C CHARGER
- D DISTRIBUTION
- E ENTERTAINMENT
- F FUEL
- G GALLEY
- H HEATER
- I INVERTER
- J JUNCTION
- K KITCHEN
- L LIGHTS
- M MAIN
- N NEUTRAL
- O OUTLETS
- P PUMP
- Q QUANTITY
- R REFRIGERATOR
- S SWITCH
- T TERMINAL
- U UNDER
- V VOLTAGE
- W WATER
- X X-RAY
- Y YIELD
- Z ZONE

REGAL BOATS

TITLE: 38SA 240/120 VAC MDP

DATE: 02/01/2010

REV: 381940

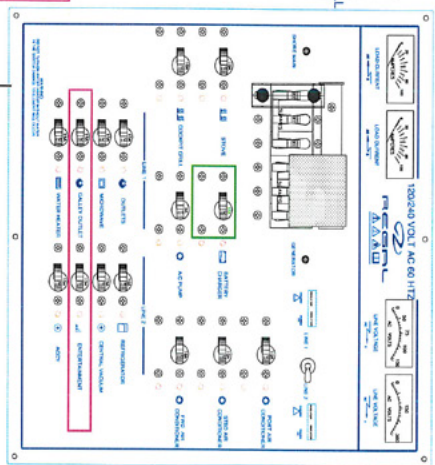

38GC & 38XO 12 VOLT DC DISTRIBUTION PANEL

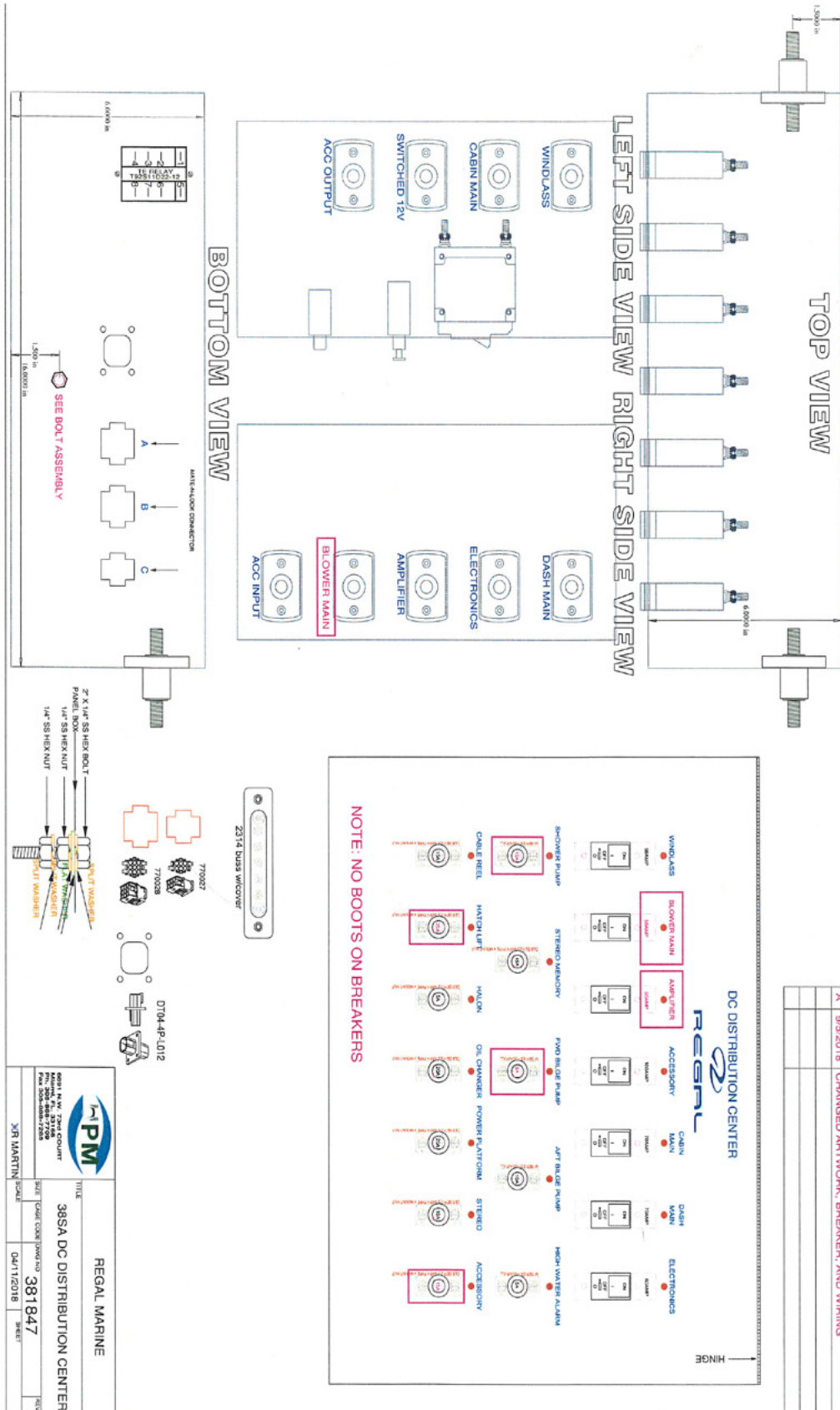

38GC & 38XO 12 VOLT DC DISTRIBUTION PANEL-REAR

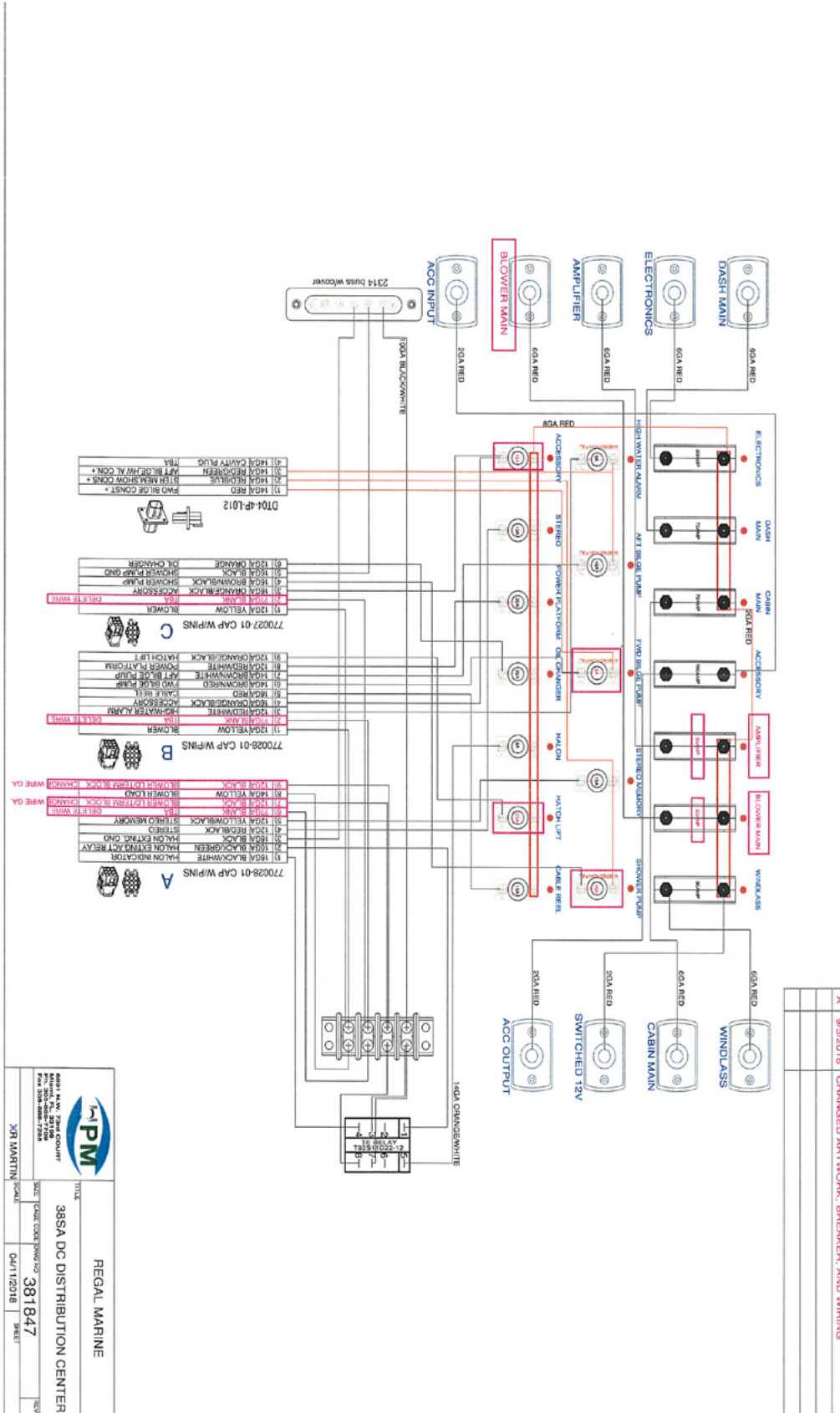

A	9/5/2018	CHANGED ARTWORK, BREAKER, AND WIRING



 6881 N.W. 72nd COURT
 MIAMI, FL 33156
 TEL: 305-553-7200
 FAX: 305-553-7204

TITLE: REGAL MARINE
 PROJECT: 38SA DC DISTRIBUTION CENTER
 SHEET: 381847
 SCALE: 04/1/2018

38GC & 38XO POTABLE WATER TANK 1

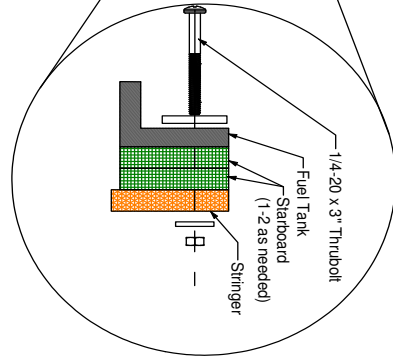
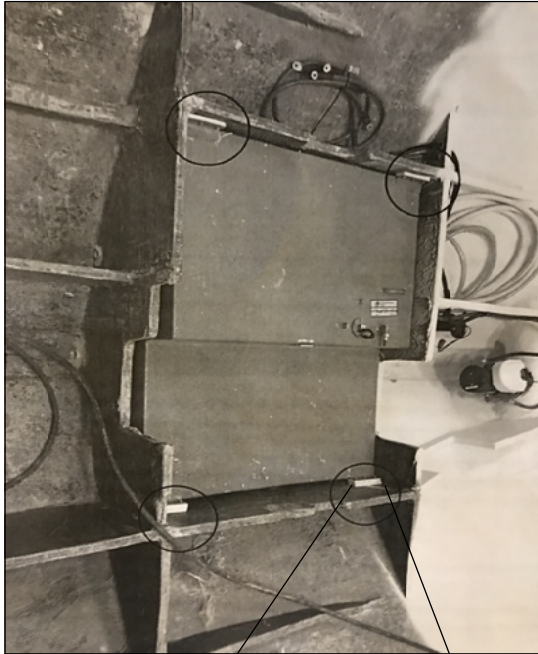

REFERENCE ONLY

PROPRIETARY AND CONFIDENTIAL.
THE INFORMATION CONTAINED IN THIS DRAWING IS THE SOLE PROPERTY OF REGAL MARINE INDUSTRIES. REPRODUCTION OR TRANSMISSION IN ANY FORM OR BY ANY MEANS WITHOUT THE WRITTEN PERMISSION OF REGAL MARINE INDUSTRIES IS PROHIBITED.

<p style="font-size: 0.8em; margin: 0;">REGAL MARINE INDUSTRIES 2200 KENNEDY BLVD TEL: (407) 851-4300</p>		<p style="font-size: 0.8em; margin: 0;">ALL RIGHTS RESERVED</p>	
<p style="font-size: 0.8em; margin: 0;">DRAWING TITLE</p> <p style="font-weight: bold; margin: 0;">38 GC (SA) Water Tank Routings/Installation</p>			
DATE	DRAWN BY	APPROVED BY	DRAW NO.
10/9/2018	DMC	-	1 OF 5
			<p style="font-size: 0.7em; margin: 0;">TRACE</p> <p style="font-weight: bold; margin: 0;">MSASB23F</p>

38GC & 38XO POTABLE WATER TANK 2

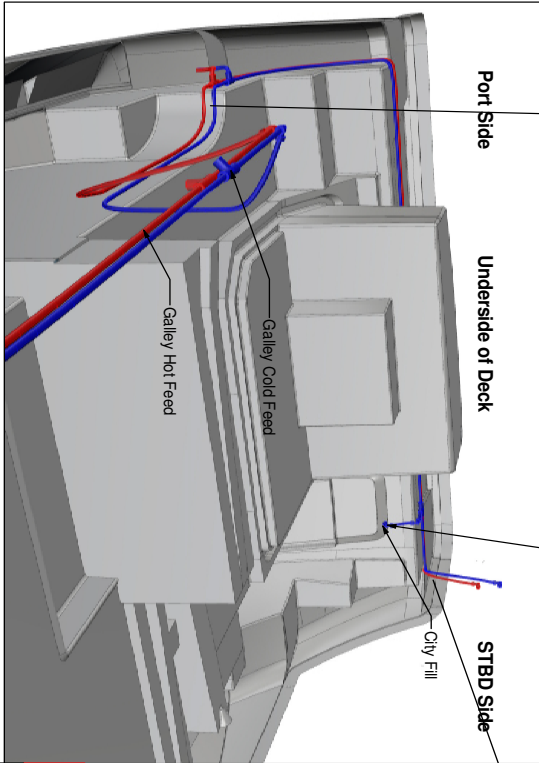
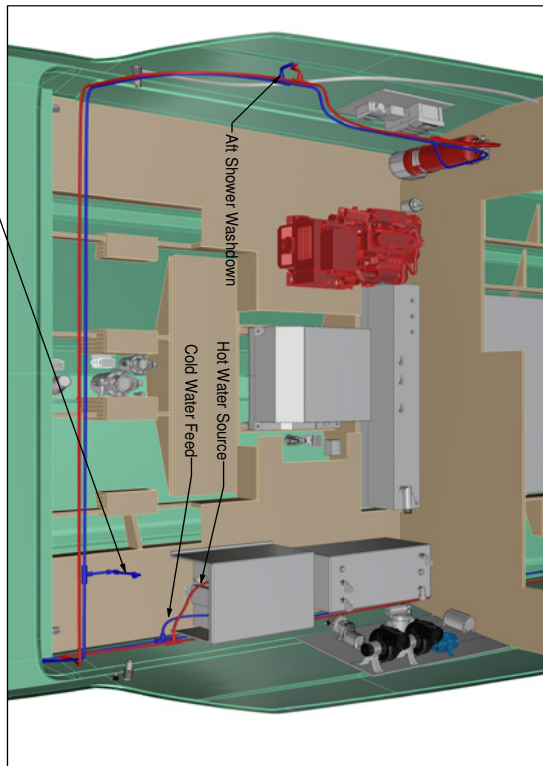
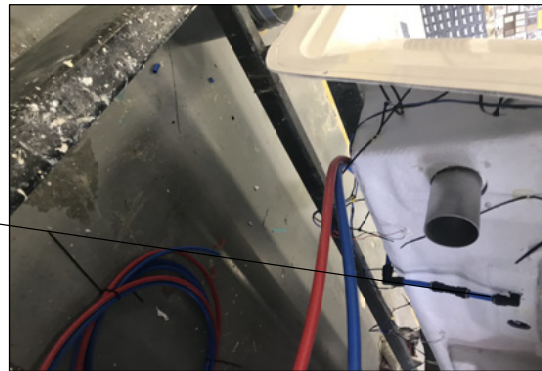
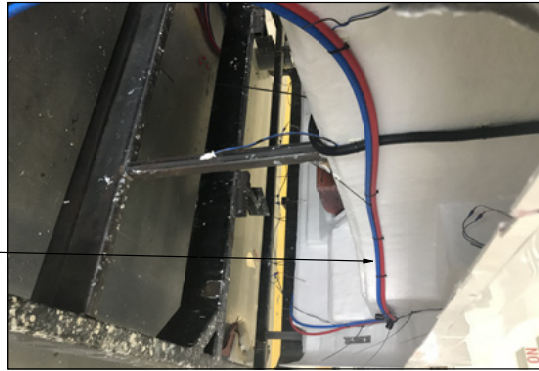

REFERENCE ONLY

PROPRIETARY AND CONFIDENTIAL.
THE INFORMATION CONTAINED IN THIS DRAWING IS THE SOLE PROPERTY OF REGAL MARINE
INDUSTRIES. NO PART OF THIS DRAWING MAY BE REPRODUCED OR TRANSMITTED IN ANY FORM OR BY ANY MEANS
WITHOUT THE WRITTEN PERMISSION OF REGAL MARINE INDUSTRIES IS REQUIRED.

 REGAL MARINE INDUSTRIES 28001 IMPERIAL DRIVE FORT WORTH, TEXAS 76149 TEL: (817) 861-4400 ALL RIGHTS RESERVED	
DRAWING TITLE 38 GC (SA) Water Tank Routings/Installation	REVISION DATE: 10/9/2018 DRAWN BY: DMC APPROVED BY: - DWG. NO.: MSASB23F
PAGE 2 OF 5	

38GC & 38XO POTABLE WATER TANK 3

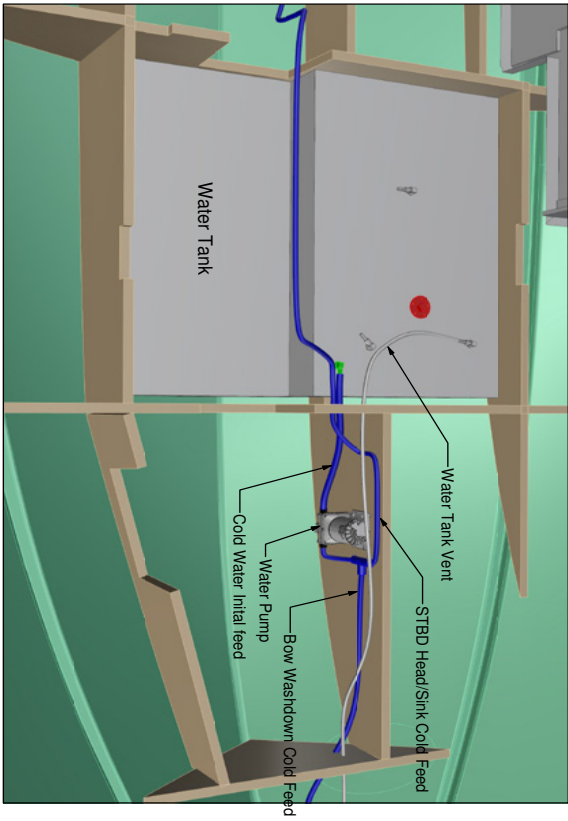
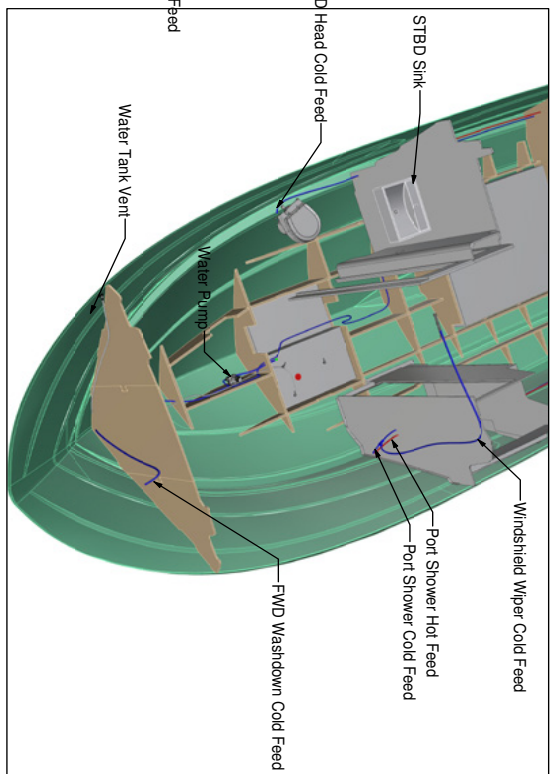
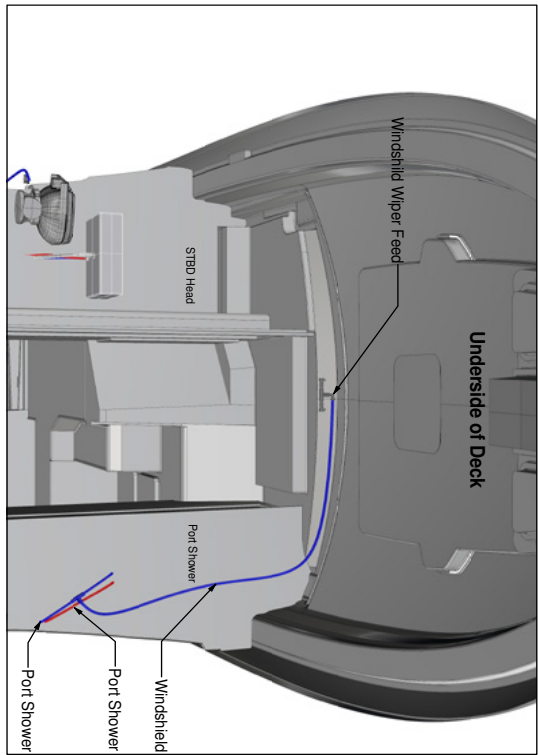

REFERENCE ONLY

PROPERTY AND CONFIDENTIAL. THE INFORMATION CONTAINED IN THIS DRAWING IS THE SOLE PROPERTY OF REGAL MARINE INDUSTRIES. REPRODUCTION OR TRANSMISSION IN ANY FORM OR BY ANY MEANS WITHOUT THE WRITTEN PERMISSION OF REGAL MARINE INDUSTRIES IS PROHIBITED.

 REGAL MARINE INDUSTRIES 25001 SPORT DRIVE BOAT TEL: (977) 81-4400 ALL RIGHTS RESERVED		DRAWING TITLE 38 GC (SA) Water Tank Routings/Installation
DATE 10/9/2018	REVISION -	PAGE NO. 3 OF 5
COMPANY DMC	APPROVED BY -	DWG. NO. MSASB23F

38GC & 38XO POTABLE WATER TANK 4

Port Side Hull Liner (Exterior)

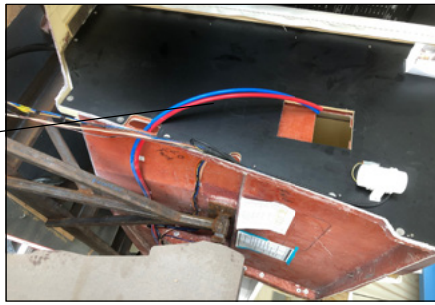

STBD Sink Cold Feed

STBD Sink Drain

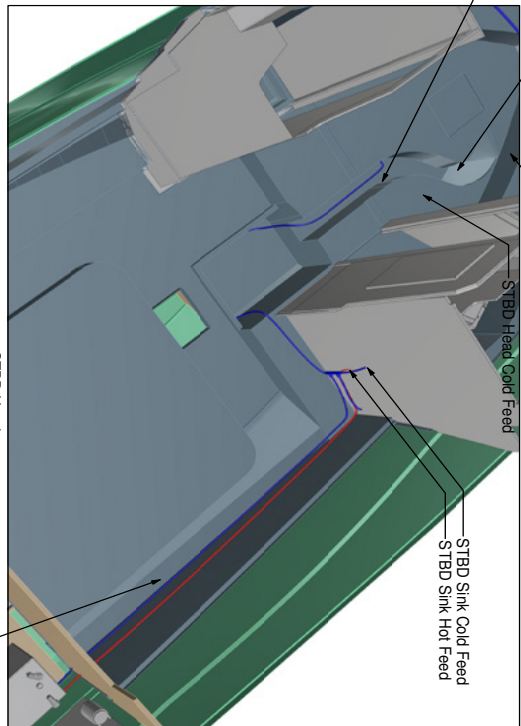

STBD Sink Cold Feed

Windshield Wiper Feed

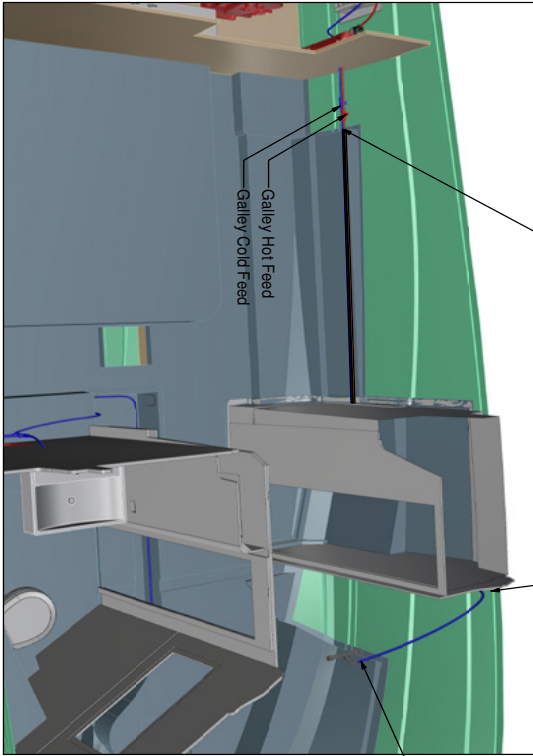

Galley Hot Feed

Galley Cold Feed

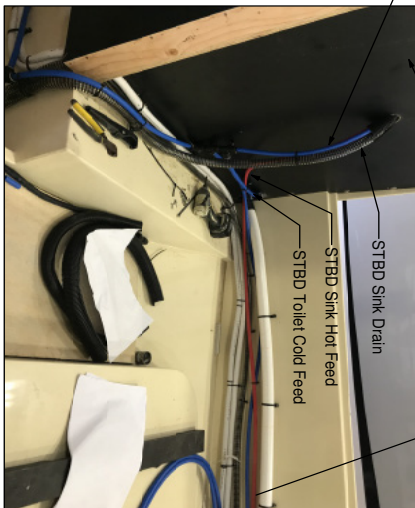

STBD Sink Drain

STBD Sink Hot Feed

STBD Toilet Cold Feed

STBD Head

REFERENCE ONLY

PROPRIETARY AND CONFIDENTIAL. THIS INFORMATION CONTAINED HEREIN IS THE SOLE PROPERTY OF REGAL MARINE INDUSTRIES. REPRODUCTION OR TRANSMISSION OF THIS INFORMATION WITHOUT THE WRITTEN PERMISSION OF REGAL MARINE INDUSTRIES IS PROHIBITED.

 REGAL MARINE INDUSTRIES 25001 IMPERIAL DRIVE FORT WORTH, TEXAS 76149 TEL: (817) 651-4400 FAX: (817) 651-4400 ALL RIGHTS RESERVED	
DRAWING TITLE 38 GC (SA) Water Tank Routings/Installation	DATE 10/9/2018
DRAWN BY DMC	CHECKED BY -
DMC	TRAILER 4 OF 5
MSASB23F	

38GC & 38XO POTABLE WATER TANK 5

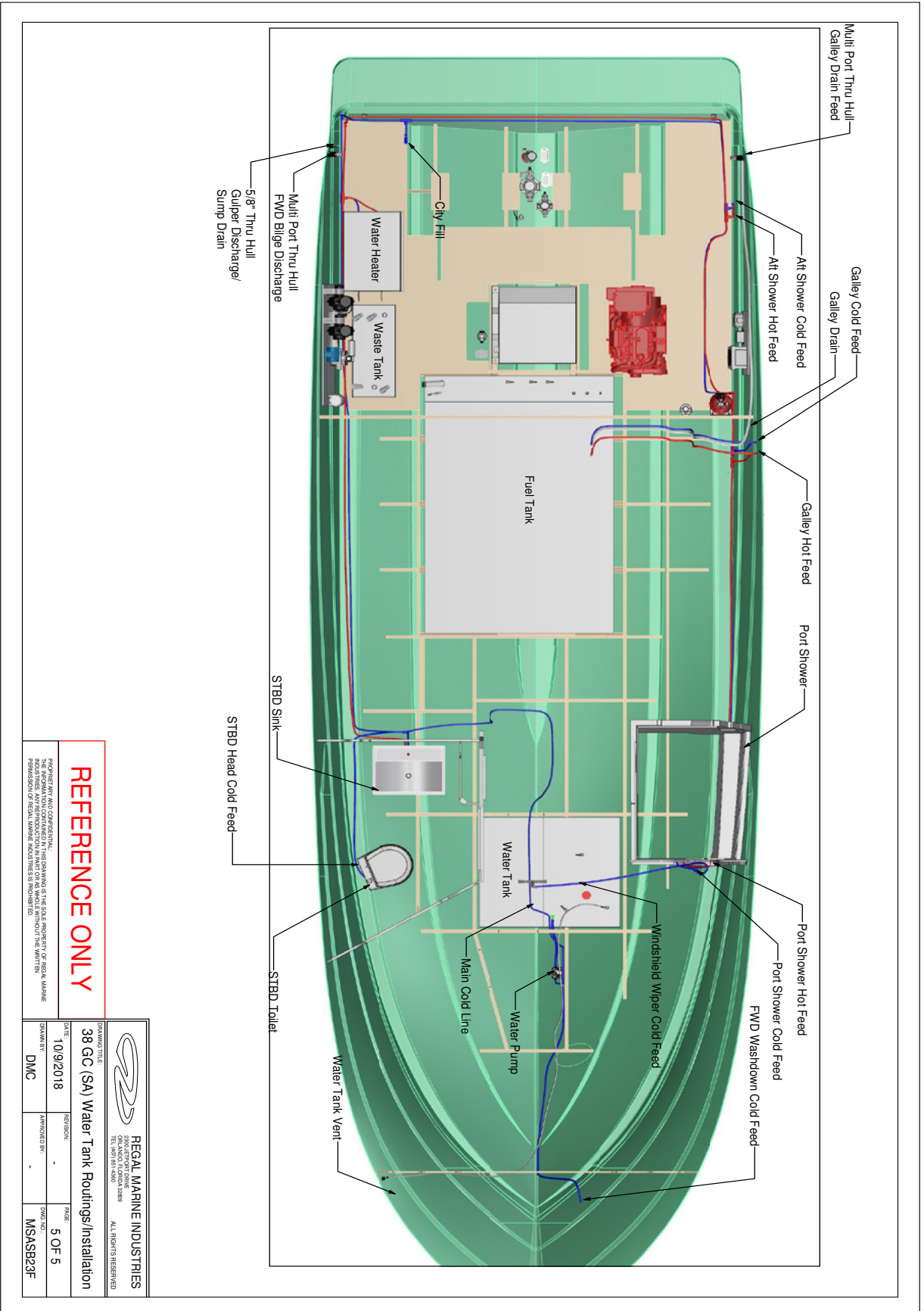

REFERENCE ONLY

REGAL MARINE INDUSTRIES
 25001 IMPERIAL AVENUE
 FORT WORTH, TEXAS 76149
 TEL: (817) 851-4400
 FAX: (817) 851-4400
 WWW.REGALMARINE.COM

 REGAL MARINE INDUSTRIES 25001 IMPERIAL AVENUE FORT WORTH, TEXAS 76149 TEL: (817) 851-4400 FAX: (817) 851-4400 WWW.REGALMARINE.COM ALL RIGHTS RESERVED	
DRAWING TITLE 38 GC (SA) Water Tank Routings/Installation	TRADE NO. 5 OF 5
DATE 10/9/2018	APPROVED BY _____
DRAWN BY DMC	TRADE NO. MSASB23F

38GC & 38XO WASTE TANK HOSE ROUTING

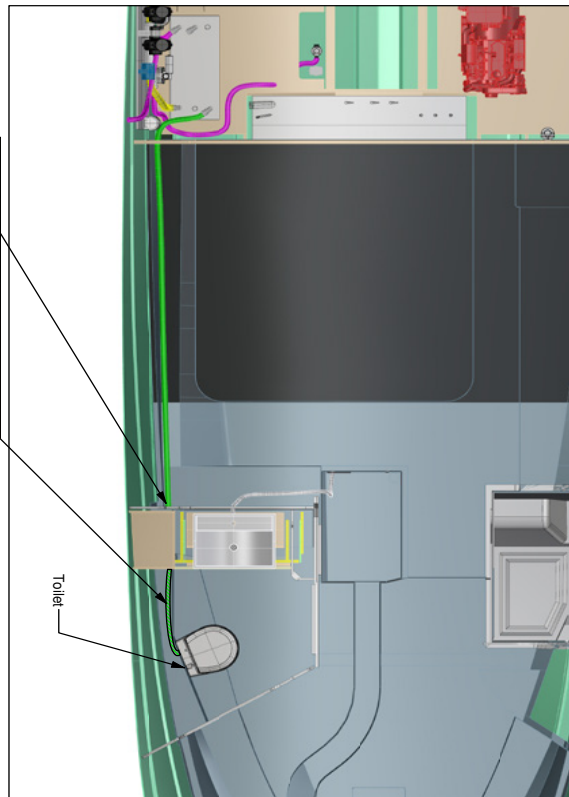
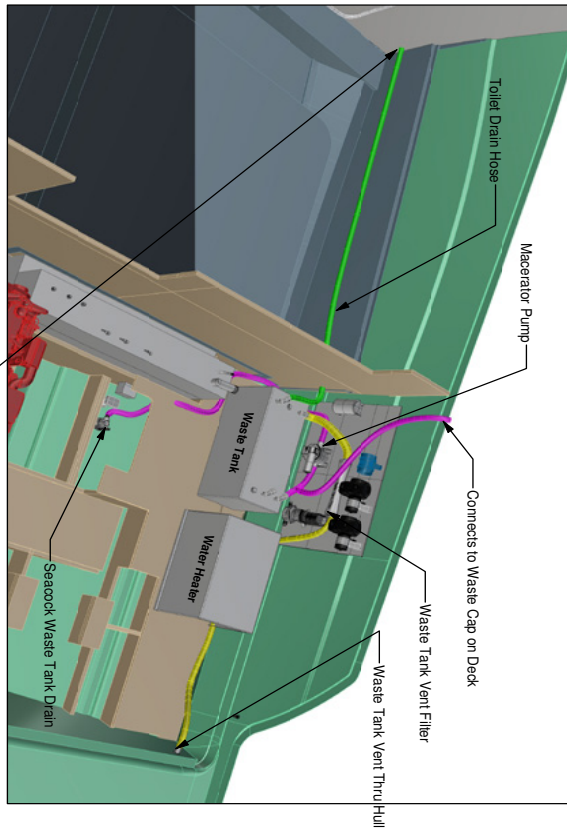

Waste Hose Routing
All Waste Hose Sizes: Ø 1 1/2"

REFERENCE ONLY

PROPER INSTALLATION AND CONNECTIONS ARE THE SOLE RESPONSIBILITY OF THE INSTALLER. THE INFORMATION CONTAINED IN THIS DRAWING IS THE SOLE PROPERTY OF REGAL MARINE INDUSTRIES. PERMISSION OF REGAL MARINE INDUSTRIES IS REQUIRED TO REPRODUCE THIS DRAWING.

 REGAL MARINE INDUSTRIES 25001 IMPERIAL DRIVE FORT WORTH, TEXAS 76140 TEL: (817) 831-4400 ALL RIGHTS RESERVED		DRAWING TITLE 38 GC (SA) Waste Hose Routings
DATE	9/18/2018	REVISION
DRAWN BY	DMC	APPROVED BY
SCALE	1 OF 1	FIGURE NO.
		MSASB23D

38GC & 38XO DRAIN HOSE ROUTING

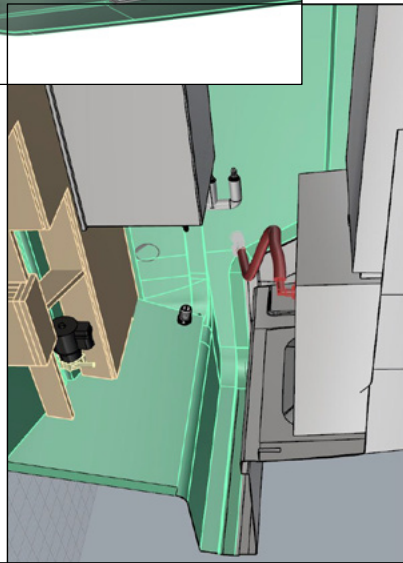
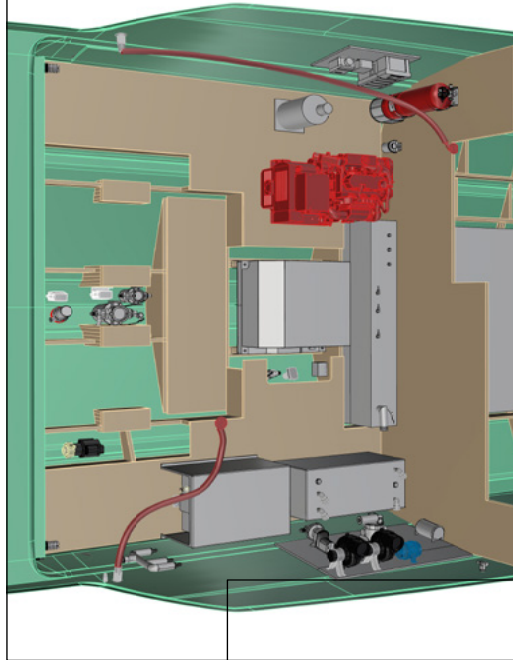
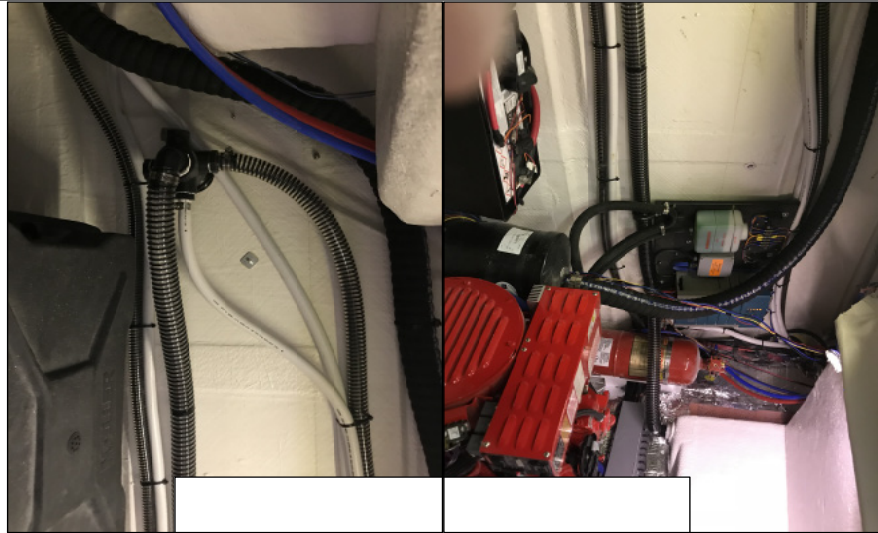

REFERENCE ONLY

PROPRIETARY AND CONFIDENTIAL.
THE INFORMATION CONTAINED IN THIS DRAWING IS THE SOLE PROPERTY OF REGAL MARINE
INDUSTRIES. REPRODUCTION OR TRANSMISSION OF THIS DRAWING WITHOUT THE WRITTEN
PERMISSION OF REGAL MARINE INDUSTRIES IS PROHIBITED.

 REGAL MARINE INDUSTRIES <small>2500 IMPERIAL DRIVE FORT WORTH, TEXAS 76140 TEL: (817) 651-4400</small>		<small>ALL RIGHTS RESERVED</small>	
<small>DRAWING TITLE</small>	38 GC (SA) Cockpit Drain Hose Routings	<small>DATE</small>	1/24/2019
<small>DESIGNED BY</small>	DMC	<small>APPROVED BY</small>	-
<small>TRIAL NO.</small>	MSA23E	<small>PAGE NO.</small>	1 OF 1

38GC & 38XO LIFT SLING LOCATIONS

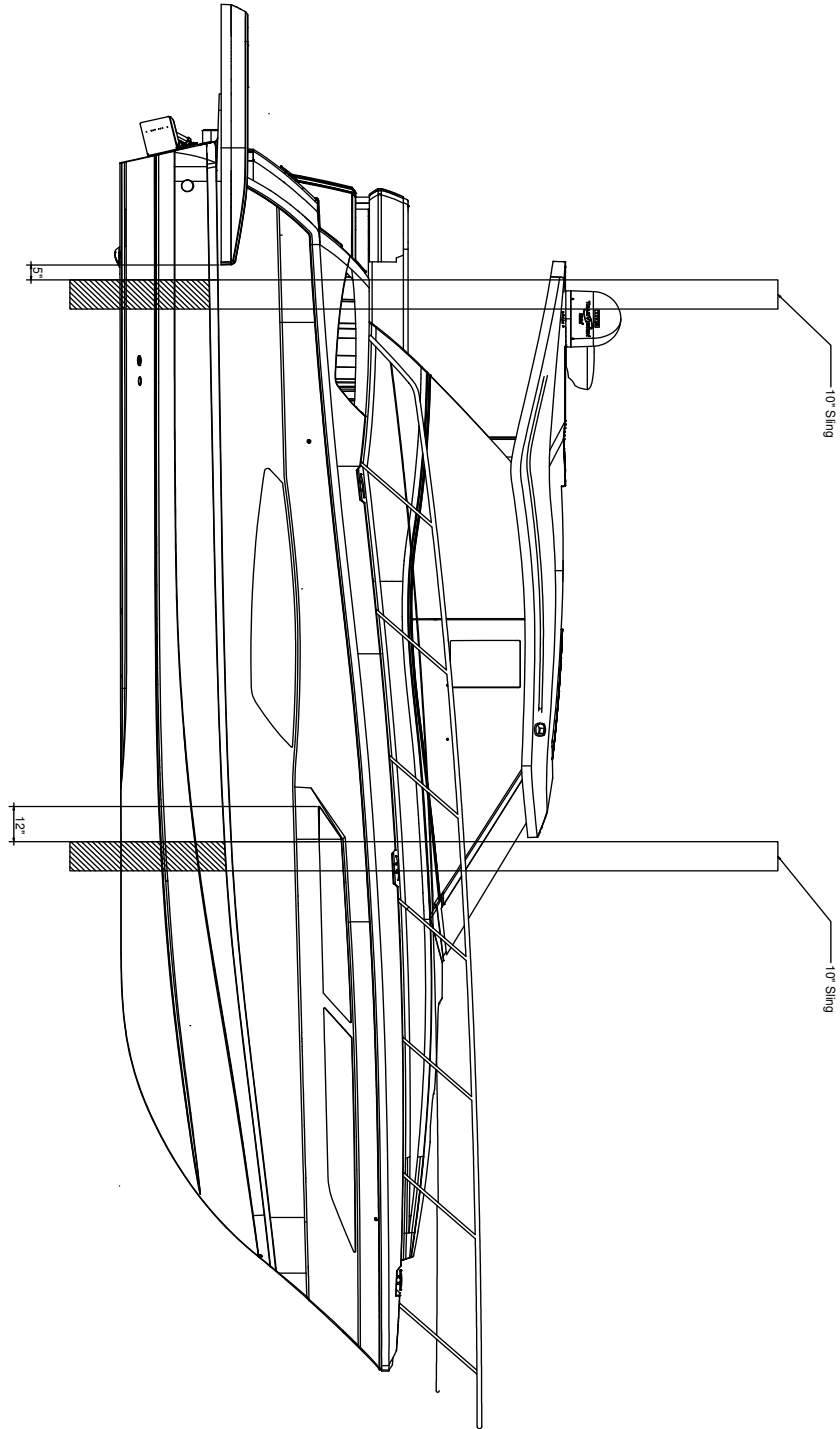

REFERENCE ONLY

PROPRIETARY AND CONFIDENTIAL.
THE INFORMATION CONTAINED IN THIS DRAWING IS THE SOLE PROPERTY OF REGAL MARINE.
PERMISSION OF REGAL MARINE INDUSTRIES IS PROHIBITED.

 REGAL MARINE INDUSTRIES 2000 ALBERT DRIVE BOCA RATON, FL 33433 TEL: (407) 961-4300 ALL RIGHTS RESERVED			
DRAWING TITLE		38 GC (SA) Sling Locations	
DATE	REVISION	APPROVED BY	PAGE
9/28/2018	-	Dion C	1 OF 1
DRAWN BY		DWG. NO.	
DMC		MSASB25F	

38GC & 38XO HULL/DECK JOINT

- NOTES:
1. SCREW TOGETHER REMAINING LOCATIONS EVERY 6 TO 8 INCHES.
 2. SEAL HULL DECK SHEER AS SPECIFIED ON WS047

SEE NOTE

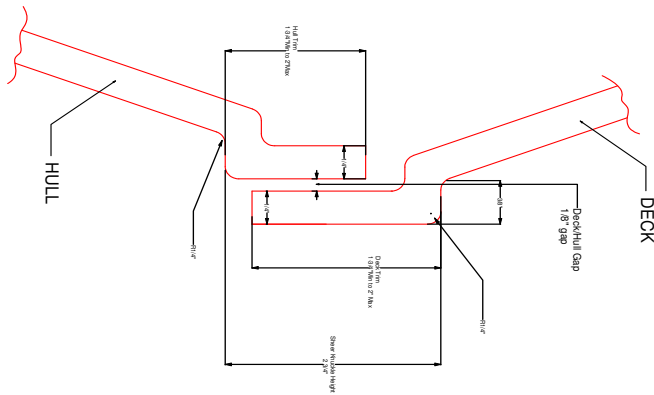
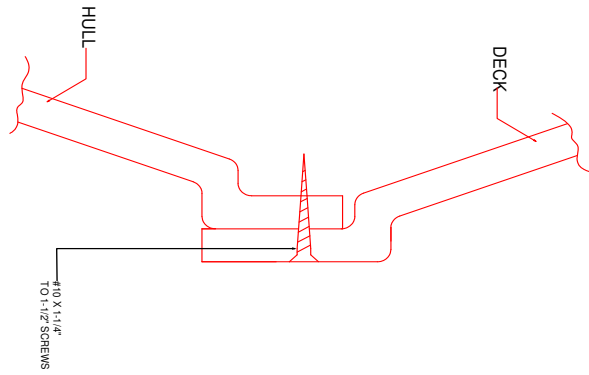

 REGAL MARINE INDUSTRIES 2500 SOUTH LAKE DRIVE TAMPA, FL 33629 TEL: 813/973-4800		ALL RIGHTS RESERVED	
DRAWING TITLE: 38 GC (SA) Main Dimensions			
DATE:	10/10/17	REVISION:	
DRAWN BY:	JPG	APPROVED BY:	Dennis R.
SCALE:	1 OF 1	DWG NO.:	9

PROPRIETARY AND CONFIDENTIAL. THE INFORMATION CONTAINED IN THIS DRAWING IS THE SOLE PROPERTY OF REGAL MARINE INDUSTRIES. IT IS TO BE USED FOR THE INTENTIONED PURPOSES ONLY AND WITHOUT PERMISSION OF REGAL MARINE INDUSTRIES IS PROHIBITED.

38GC & 38XO STRONG POINT (TYPICAL)

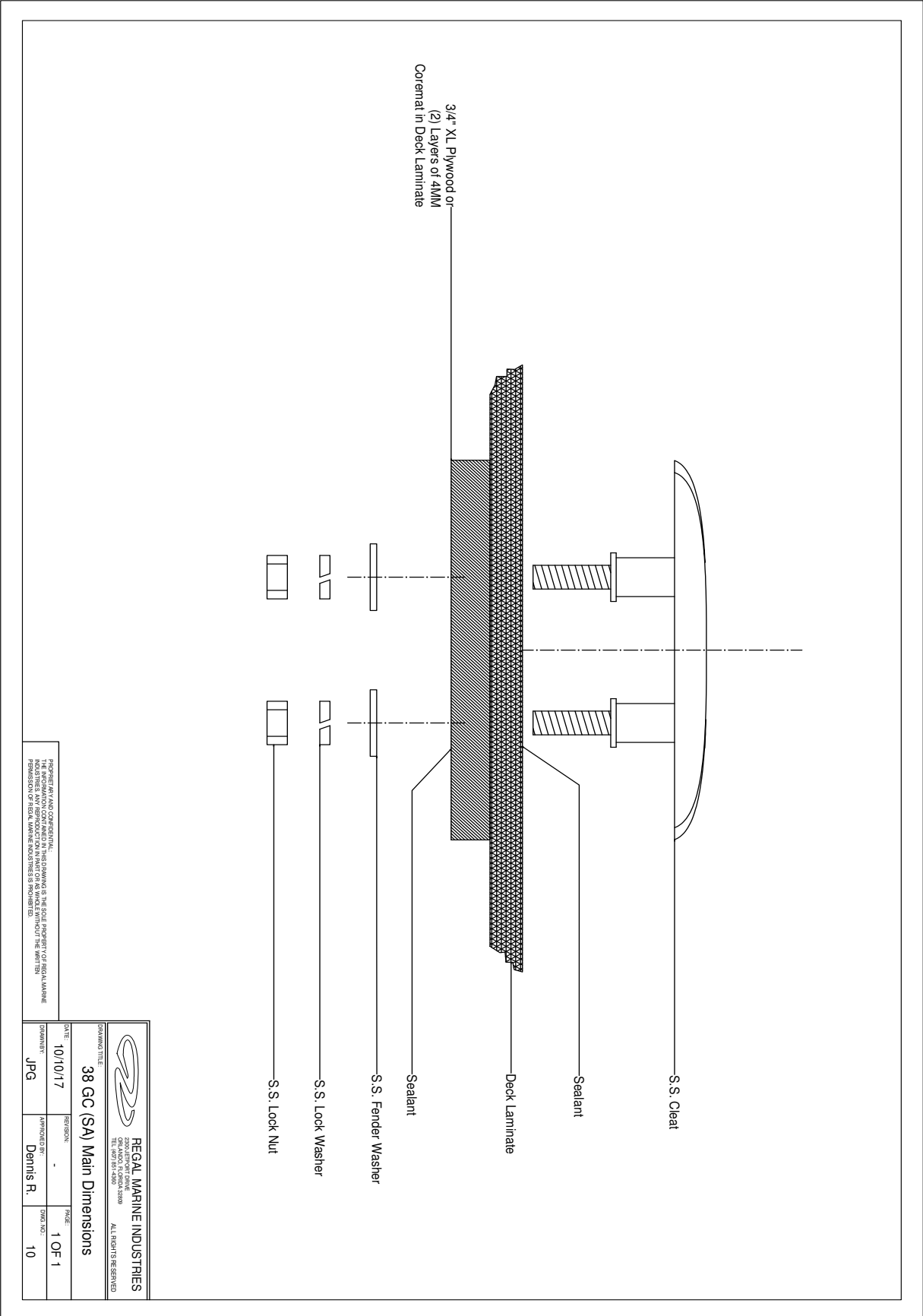

REGAL MARINE INDUSTRIES
2800 SPORTS BLVD
TEL: 407/831-4400 FAX: 407/831-4400
ALL RIGHTS RESERVED

PROPERTY AND CONFIDENTIAL
THE INFORMATION CONTAINED IN THIS DRAWING IS THE SOLE PROPERTY OF REGAL MARINE
PERMISSION OF REGAL MARINE INDUSTRIES IS REQUIRED.

DATE: 10/10/17
DRAWN BY: JPG
APPROVED BY: Dennis R.
SCALE: 1 OF 1
DWG. NO.: 10

DRAWING TITLE: 38 GC (SA) Main Dimensions

38GC & 38XO UPHOLSTERY IDENTIFIER 1

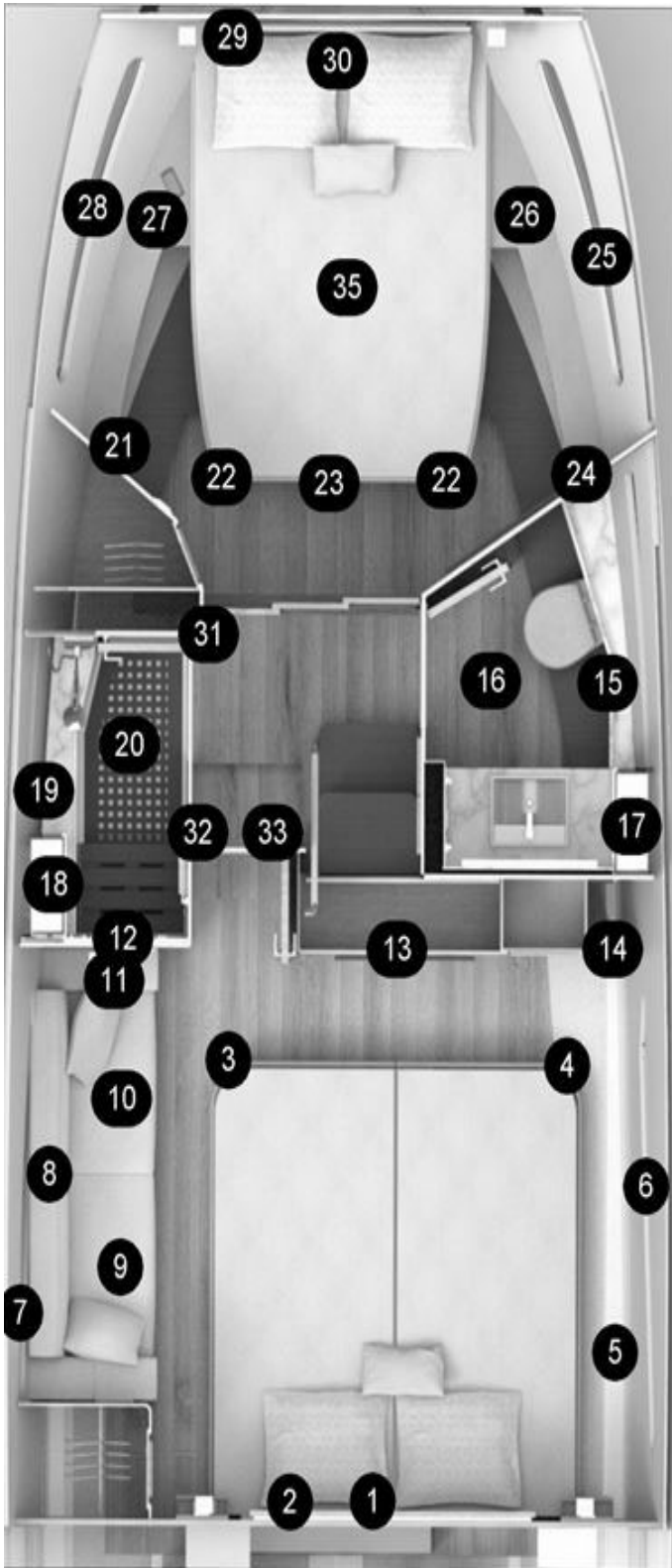

38GC UPHOLSTERY IDENTIFIER

Bundle	Assembly	Description
1	USA01A	Aft Stateroom Bulkhead
2	USA01B	Aft Stateroom Headboard
3	USA01C	Aft Port Stateroom Bunk Keeper
4	USA01D	Aft Stbd Stateroom Bunk Keeper
5	USA01E	Aft Stateroom Stbd Hose Cover
6	USA01F	Stbd Aft Window Trim
7	USA01G	Port Aft Window Trim
8	USA01H	Settee Backrest
9	USA01J	Aft Settee Cushion
10	USA01K	Frwd Settee Cushion
11	USA01L	Frwd Settee Armrest
12	USA01M	Aft Port Shower Bulkhead
13	USA01N	Aft Stateroom TV Cabinet
14	USA01P	Aft Stateroom Fwd Otbd Bulkhead
15	USA06A	Stbd Head Window Trim
16	USA06B	Head Overhead Panel
17	USA06C	Head Cabinet
18	USA06D	Shower Cabinet
19	USA06E	Port Head Window Trim
20	USA06F	Shower Overhead Panel
21	USA06G	Port Hanging Locker
22	USA06H	Fwd Stateroom Corner Mattress Keeper
23	USA06J	Fwd Stateroom Bunk Keeper
24	USA06K	Head Wall
25	USA06L	Stbd Fwd Window Trim
26	USA06M	Fwd Stateroom Stb Shelf
27	USA06N	Fwd Stateroom Port Shelf
28	USA06P	Port Fwd Window Trim
29	USA06Q	V-Berth Bulkhead
30	USA06R	Fwd Stateroom Headboard
31	USA06S	Frwd Shower Door
32	USA06T	Shower Wall
33	USA01S	Mid Cabin Upper Entry Muff
34	USA01T	AFT CABIN CURTAIN
35	USA06W	Hatch Headliner Panel
36	USA06X	Main Distribution Panel (MDP)
37	USA06V	V-BERTH PANELS

38GC & 38XO UPHOLSTERY IDENTIFIER 2



38	USA13K	CPKT STORAGE TABLE HOLDER
39		
40	USA14A	Salon Port Sofa Armrest
41	USA14B	Salon Port Sofa Aft Backrest
42	USA14C	Salon Port Sofa Aft Cushion
43	USA14D	Salon Port Sofa Fwd Backrest
44	USA14E	Salon Port Sofa Fwd Cushion
45	USA14F	Atrium Aft Panel
46	USA14G	Atrium Port Panel
47	USA14H	Atrium Frwd Panel
48	USA14J	Atrium G.O.V.
49	USA14K	SHOWER CURTAIN
50	USA14L	Stair Pillar
51A/B	USA14M	Port/Stbd Trim Closeout
52	USA14N	Atrium STBD Panel
53	USA13A	Dash Brow
54	USA13B	Dash
55	USA13C	Shifter Panel
56	USA13D	Helm Seat
57	USA13E	Salon Stb Sofa Fwd Armrest
58	USA13F	Salon Stb Sofa Backrest
59	USA13G	Salon Stb Sofa Cushion
60	USA13H	Salon Stb Sofa Aft Armrest
61	USA13J	Salon STBD Sofa G.O.V.
62	USA02J	STBD Fwd Column Valance
63	USA02K	Port FWD Column Valance
64	USA02L	STBD Valance
65	USA02M	Fwd Port Valance
66	USA02N	
67	USA02P	STBD Column Valance
68	USA02Q	PORT Column Valance
69	USA14P	Dash Lower Panel
70	USA15A	Patio STBD FWD Backrest
71	USA15B	Aft Patio STBD FWD Cushion
72	USA15C	Patio STBD Walk Thru Backrest
73	USA15D	Patio STBD Walk Thru Cushion
74	USA15E	Patio STBD Corner Backrest
75	USA15F	Patio STBD Corner Cushion
76	USA15G	Patio Engine Hatch Backrest

Note on the above drawing that numbers 77-87 shown above are described on the next page.

38GC & 38XO UPHOLSTERY IDENTIFIER 3

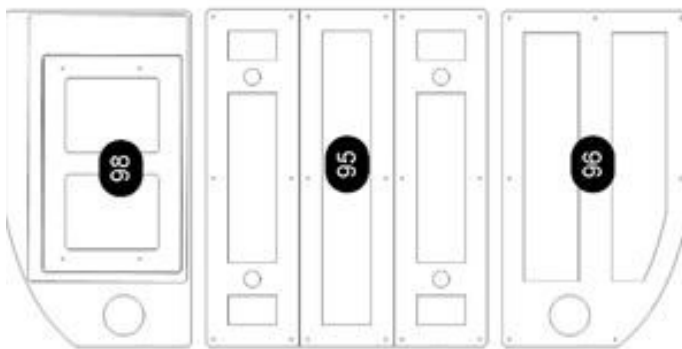
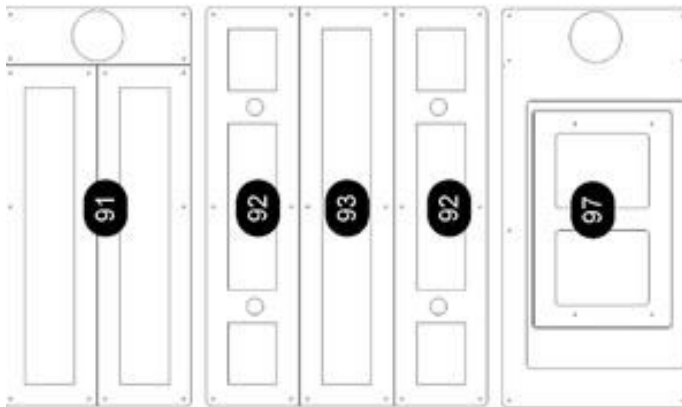

76	USA15G	Patio Engine Hatch Backrest
77	USA15H	Patio Engine Hatch Cushion
78	USA15J	Patio Engine Hatch Armrest
79	USA02R	Microwave Cabinet Panel
80	USA17A	Sunpad Cushion Port Aft
81	USA17B	Sunpad Cushion STBD Aft
82	USA17C	Sunpad Cushion Port Center
83	USA17D	Sunpad Cushion Hatch
84	USA17E	Sunpad Cushion STBD Center
85	USA17F	Sunpad Cushion STBD Aft FWD
86	USA17G	Sunpad Cushion Port Aft FWD
87	USA17H	Sunpad Cushion FWD
88		
89		
90		
91	USA02A	Salon Port Headliner Panel
92	USA02B	Salon CTR Port/Stbd Headliner Panel
93	USA02C	Salon CTR center Headliner Panel
94	USA02D	Salon Fwd Speaker Headliner Panel
95	USA02E	Cockpit CTR Headliner Panel
96	USA02F	Cockpit Stbd Headliner Panel
97	USA02G	Salon TV Panel
98	USA02H	Cockpit TV Panel
99		
100	USA06Y	HEAD WALL 2
101	USA06U	P/S V-BERT VALANCE
102	USA01Q	P/S V-BERT STATEROOM WINDOW VALANCE
103	USA01R	P/S AFT STATEROOM WINDOW PANELS

Notice

THE DRAWINGS FOLLOWING IN THIS SECTION MORE SPECIFICALLY
MATCH THE 38GC STERN DRIVE VESSEL.

38GC PROFILE

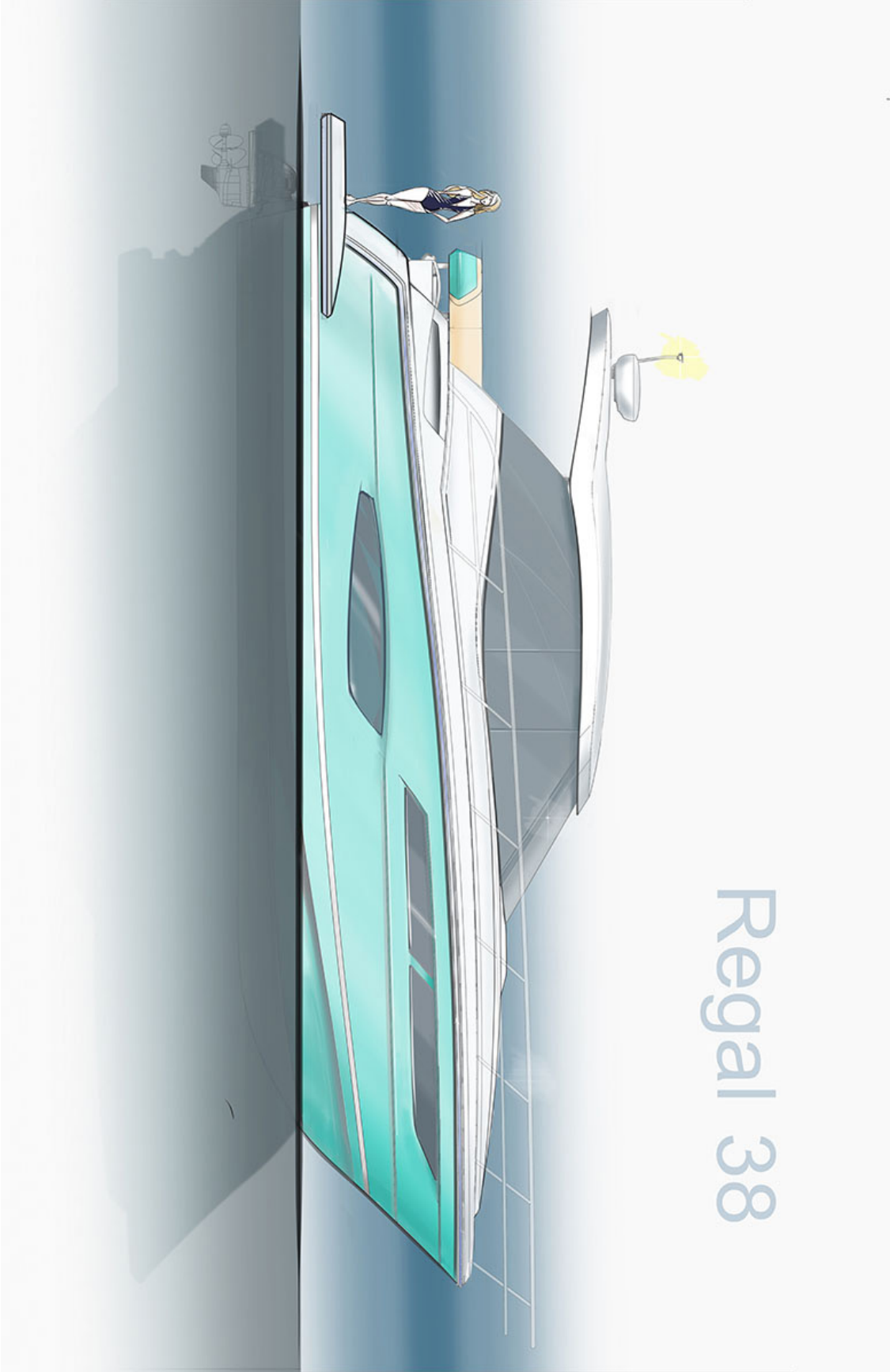

Regal 38

38GC TOP VIEW



38GC TOP VIEW INTERIOR



38GC ELECTRICAL SYSTEM OVERVIEW- EARLIER

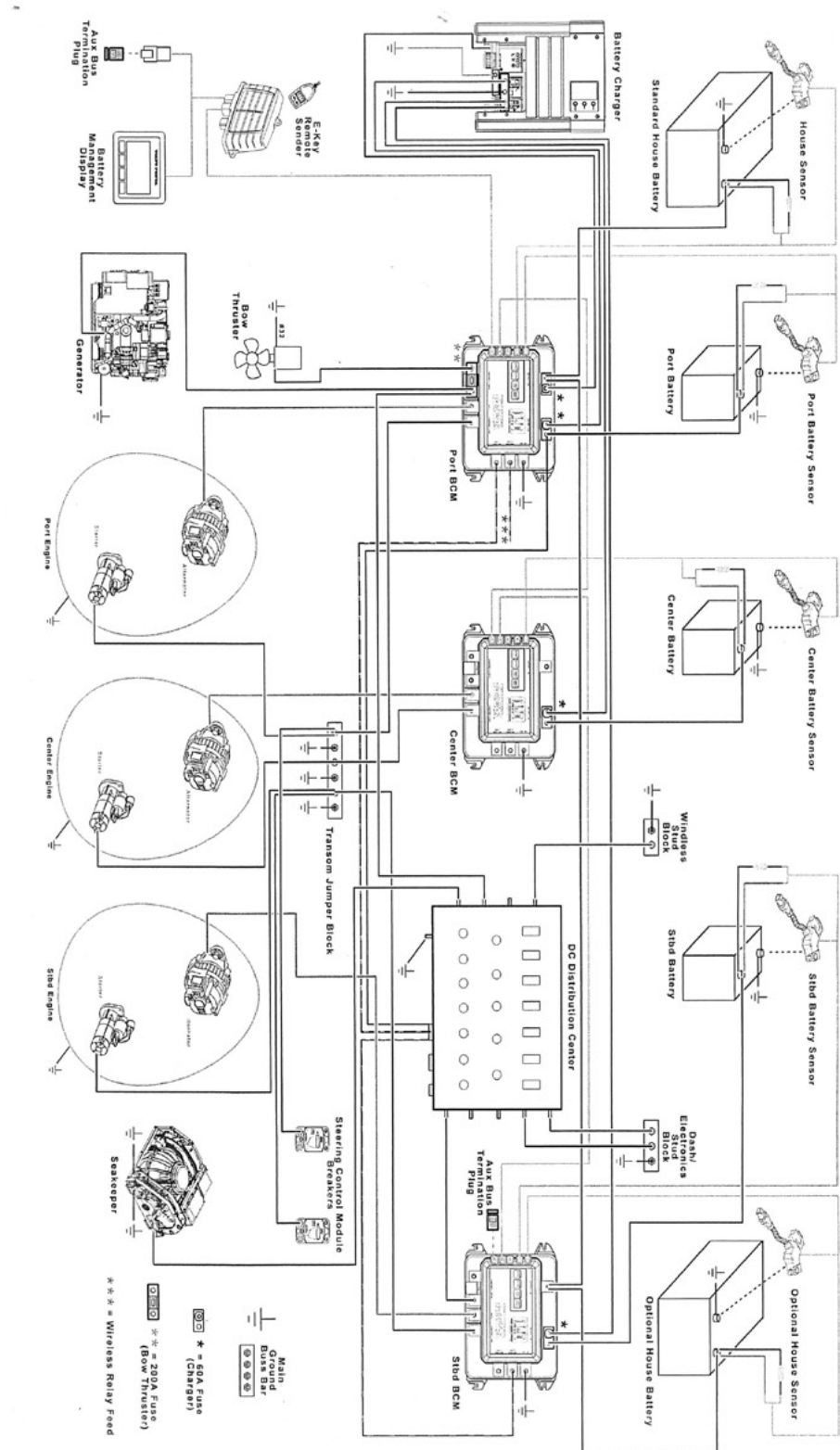

38GC PROFILE-BASIC DIMENSIONS

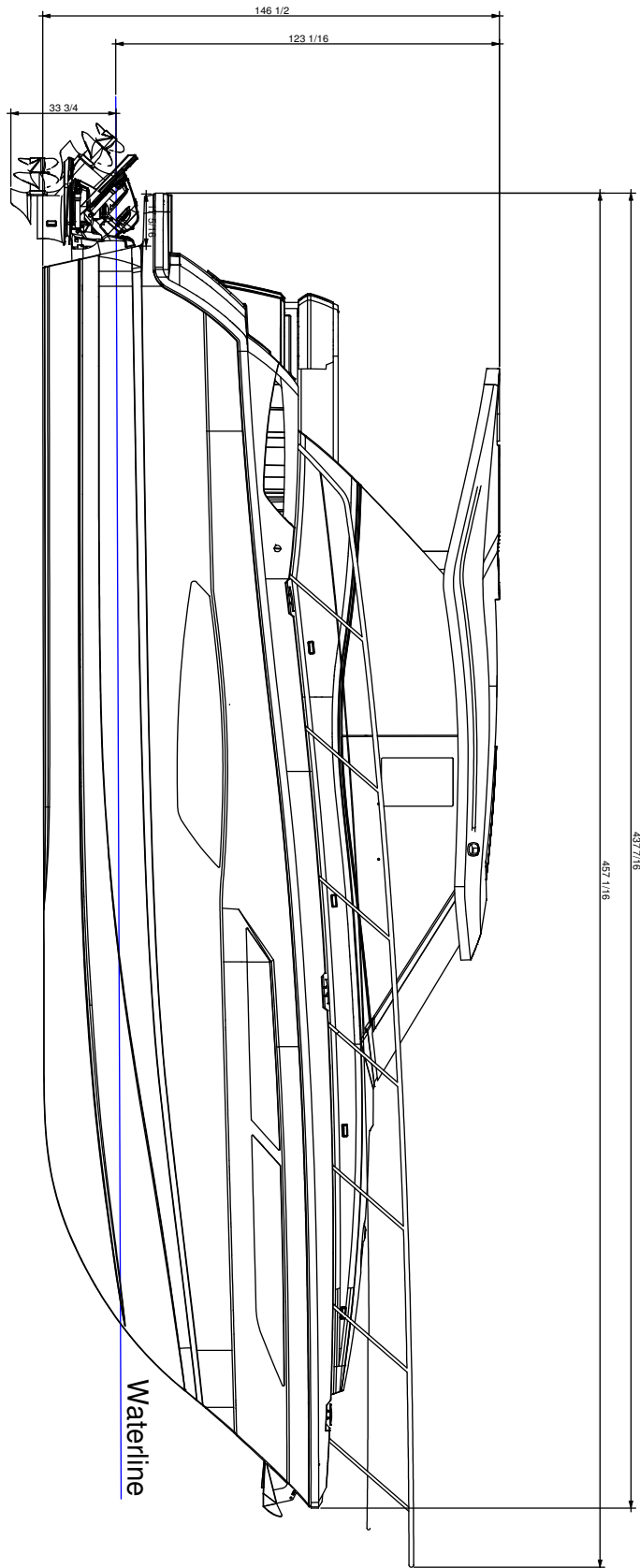

PROPRIETARY AND CONFIDENTIAL.
 THE INFORMATION CONTAINED IN THIS DRAWING IS THE SOLE PROPERTY OF REGAL MARINE.
 PERMISSION OF REGAL MARINE INDUSTRIES IS PROHIBITED.

 <p>REGAL MARINE INDUSTRIES 2500 AIRPORT BLVD. FORT MYERS, FL 33909 TEL: (888) 4-REGAL</p>		ALL RIGHTS RESERVED	
<p>38 GC Main Dimensions</p>			
DATE:	08/17/2018	REVISION:	-
DRAWN BY:	JPG	APPROVED BY:	Dennis R.
PAGE:	1 OF 1	DWG NO.:	8

38GC TOP VIEW-BASIC DIMENSIONS

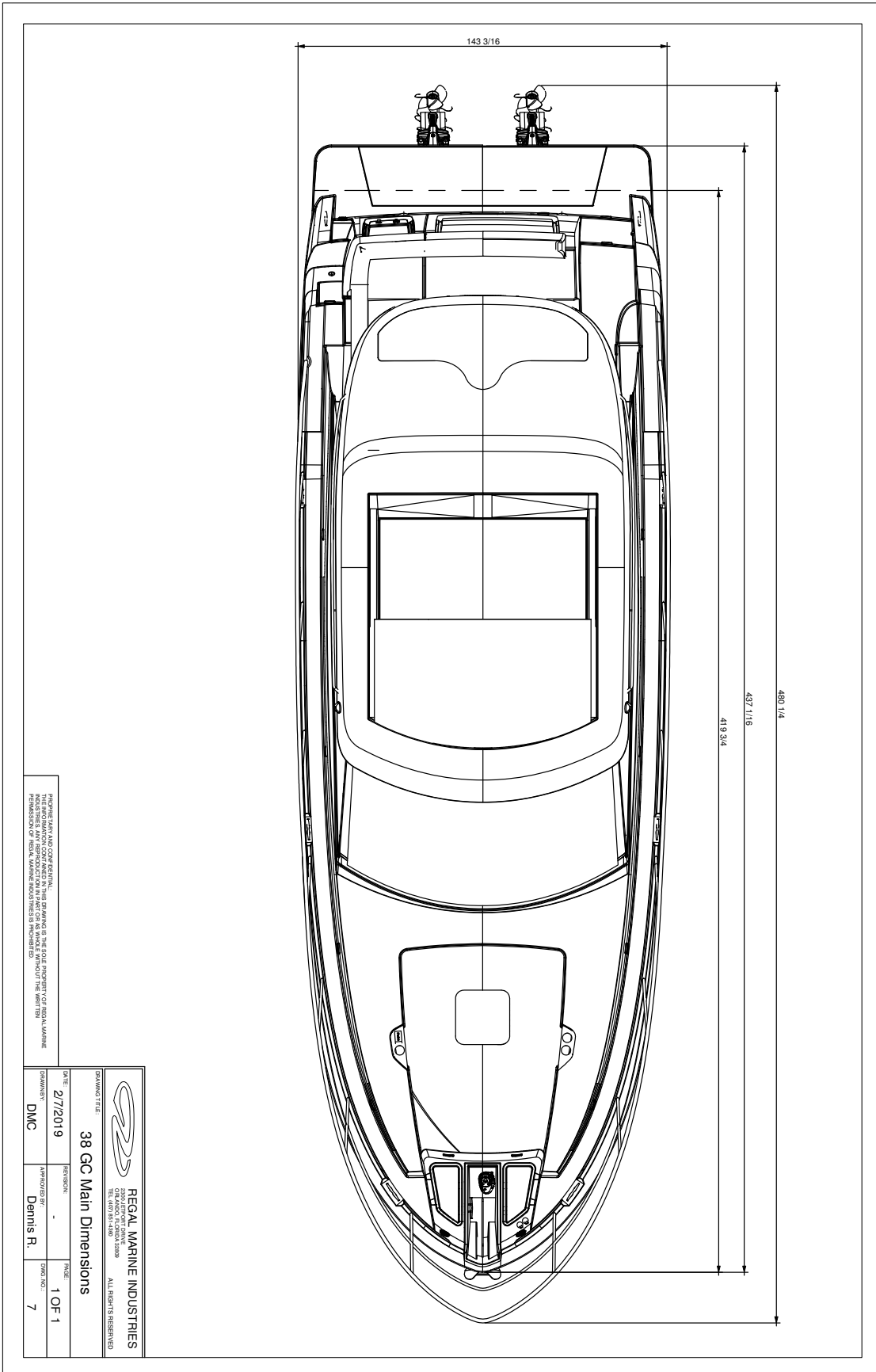

REGAL MARINE INDUSTRIES
 10000 MARINE DRIVE
 FORT MYERS, FL 33907
 TEL: 888.788.4488

 REGAL MARINE INDUSTRIES 10000 MARINE DRIVE FORT MYERS, FL 33907 TEL: 888.788.4488		ALL RIGHTS RESERVED	
38 GC Main Dimensions			
DATE	2/7/2019	REVISION	FACE
DRAWN BY	DMC	APPROVED BY	Dennis R.
		TOTAL NO.	7
		FACE	1 OF 1

38GC HORIZONTAL RANGE OF VISIBILITY

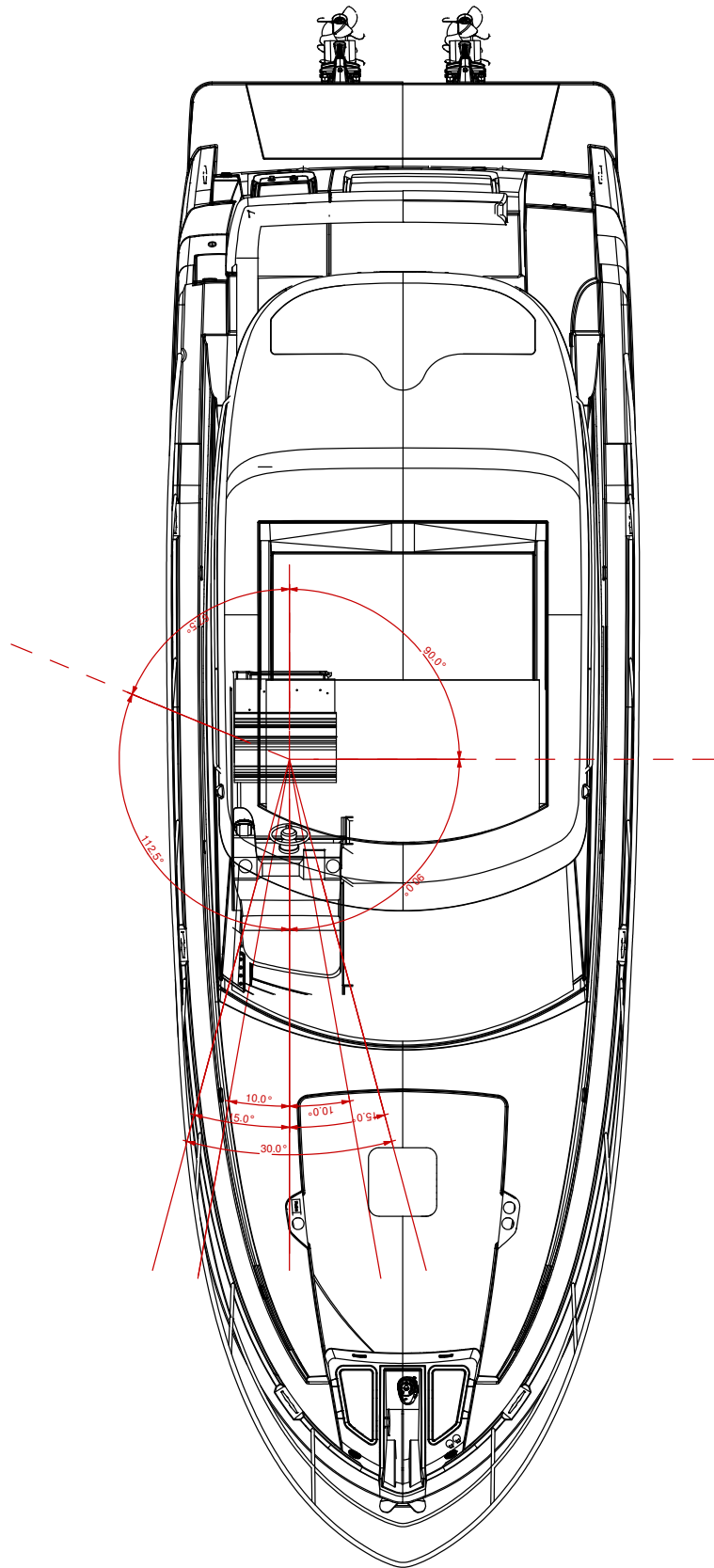

REGAL MARINE INDUSTRIES
 THE INFORMATION CONTAINED IN THIS DRAWING IS THE SOLE PROPERTY OF REGAL MARINE INDUSTRIES. NO PART OF THIS DRAWING IS TO BE REPRODUCED OR TRANSMITTED IN ANY FORM OR BY ANY MEANS, ELECTRONIC OR MECHANICAL, WITHOUT PERMISSION OF REGAL MARINE INDUSTRIES. © 2019

 REGAL MARINE INDUSTRIES 6000 WILSON AVENUE GRAND RAPIDS, MICHIGAN 49508 TEL: 616.849.4600		ALL RIGHTS RESERVED	
DATE:	2/8/2019	APPROVED BY:	Dennis R.
DESIGNED BY:	DMC	SCALE:	2 OF 2
		DRAWING NO.:	5

38GC VERTCAL RANGE OF VISIBILITY

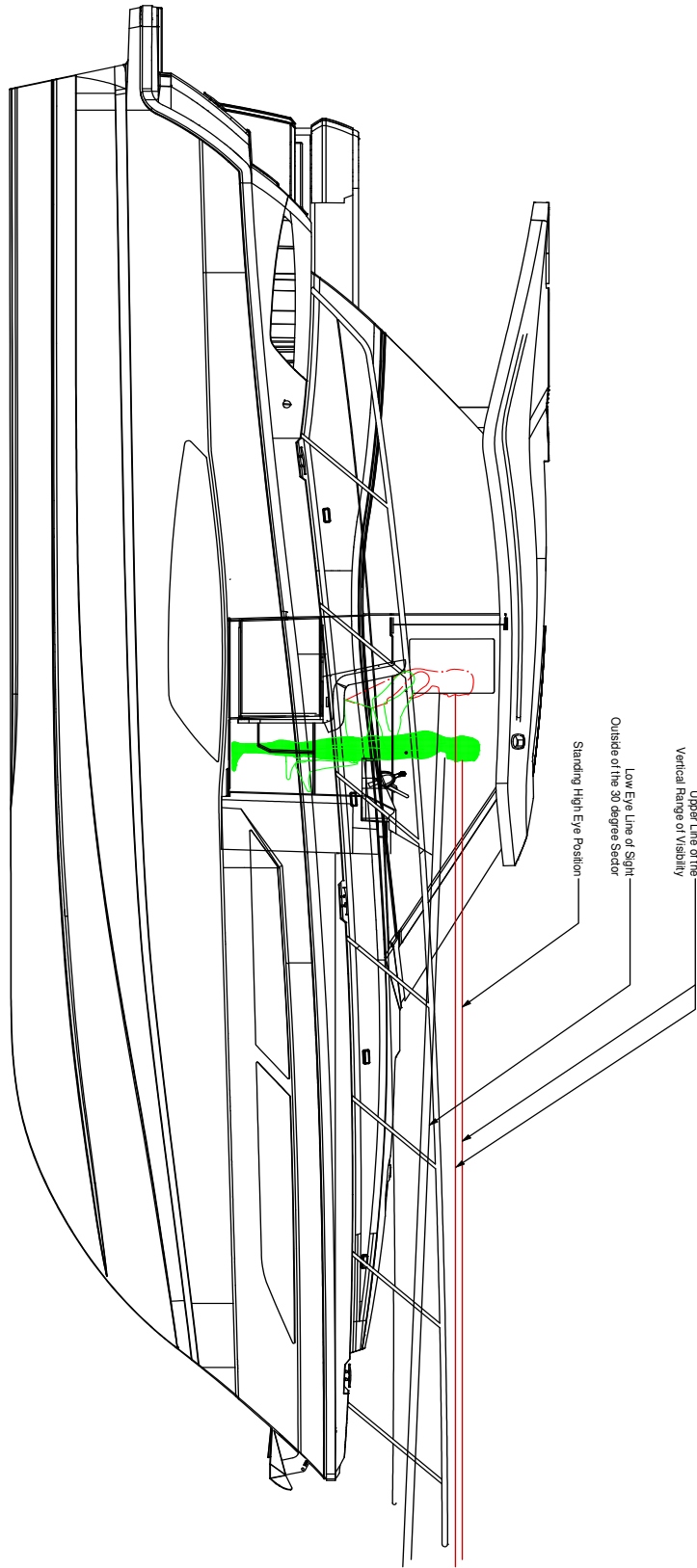

PROPRIETARY AND CONFIDENTIAL.
 THIS INFORMATION CONTAINED IN THIS DRAWING IS THE SOLE PROPERTY OF REGAL MARINE INDUSTRIES. ANY REPRODUCTION OR TRANSMISSION IN ANY FORM OR BY ANY MEANS WITHOUT THE WRITTEN PERMISSION OF REGAL MARINE INDUSTRIES IS PROHIBITED.

 REGAL MARINE INDUSTRIES 2300 E. FRONT TRAIL BOCA RATON, FL 33433 TEL: (561) 991-4800 ALL RIGHTS RESERVED					
DATE	2/8/2019	REVISION	0	PAGE	1 OF 2
DRAWN BY	DMC	APPROVED BY	Dennis R.	DWG. NO.	4
38 GC (SA) Vertical Range of Visibility					

38GC SEATING OCCUPANCY

15.5" W X 29.5" L
Allowance Per Person

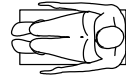

SEATING OCCUPANCY: 11 PERSONS

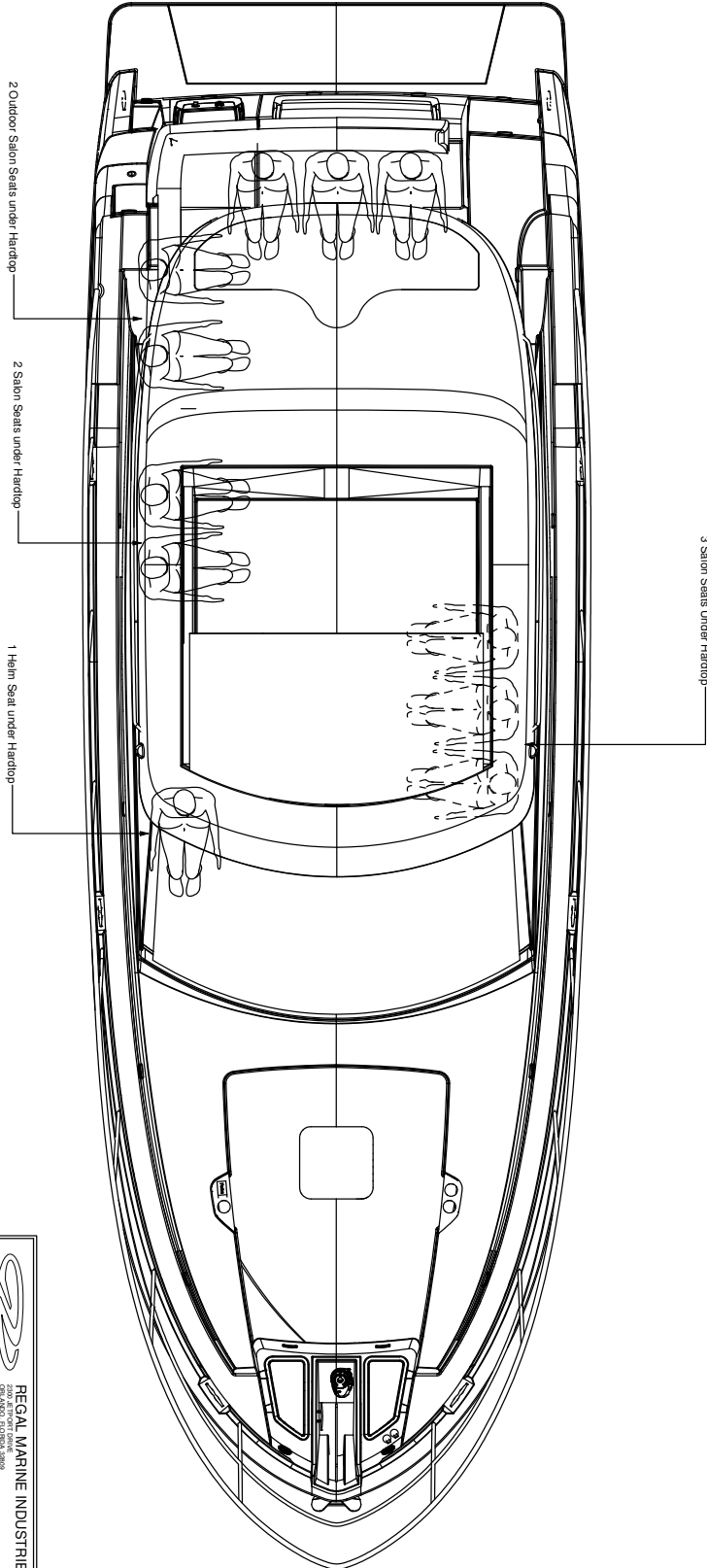

PERMIT MAY AND CONSENTING, THE EQUIPMENT, THE USE AND POSITIONING OF SEAT, MARINE
INSTALLATION, AND REPRODUCTION IN PART OR IN WHOLE WITHOUT THE WRITTEN
PERMISSION OF REGAL MARINE IS PROHIBITED.

 REGAL MARINE INDUSTRIES 2500 PONTIAC BLVD P.O. BOX 1000 BOCA RATON, FL 33432-1000 TEL: 561-999-8800 FAX: 561-999-8801 WWW.REGALMARINE.COM		ALL RIGHTS RESERVED	
38 GC Seating Capacity			
DATE:	2/7/2019	REVISED:	-
DRAWN BY:	DMC	APPROVED BY:	Dennis R.
		DWG NO.:	1 OF 1
			2

38GC SUMP LAYOUT 1

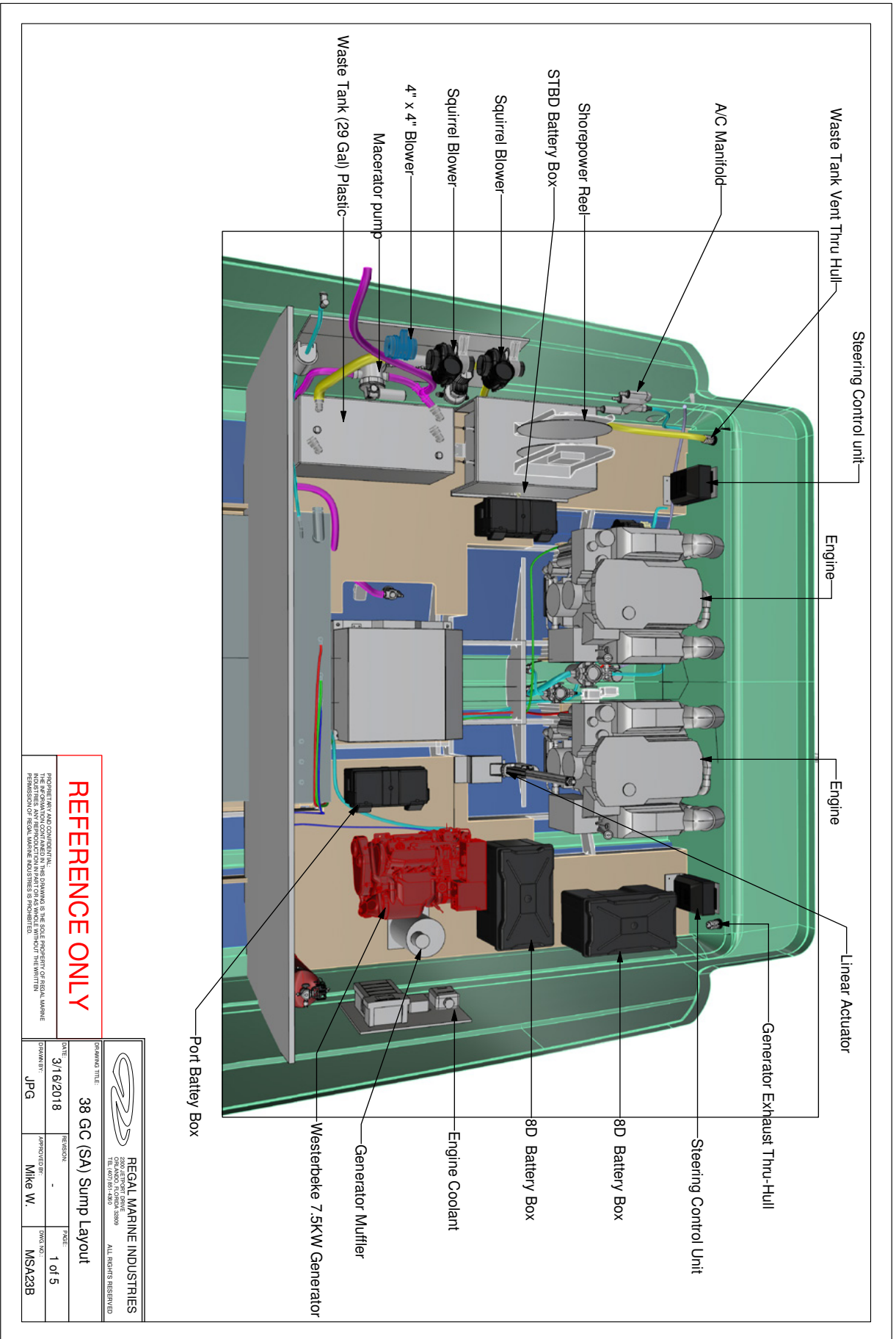

REFERENCE ONLY

PROPRIETARY AND CONFIDENTIAL.
THE INFORMATION CONTAINED IN THIS DRAWING IS THE SOLE PROPERTY OF REGAL MARINE.
PERMISSION OF REGAL MARINE INDUSTRIES IS PROHIBITED.

 REGAL MARINE INDUSTRIES <small>2000 ALBERT DRIVE WEST PALM BEACH, FL 33411 TEL: (407) 851-4800</small>		<small>ALL RIGHTS RESERVED</small>	
<small>DRAWING TITLE</small>	38 GC (SA) Sump Layout		
<small>DATE</small>	3/16/2018	<small>REVISION</small>	
<small>DRAWN BY</small>	JPG	<small>APPROVED BY</small>	Mike W.
<small>PAGE</small>	1 of 5		
<small>DWG NO.</small>	MSA23B		

38GC SUMP LAYOUT 2

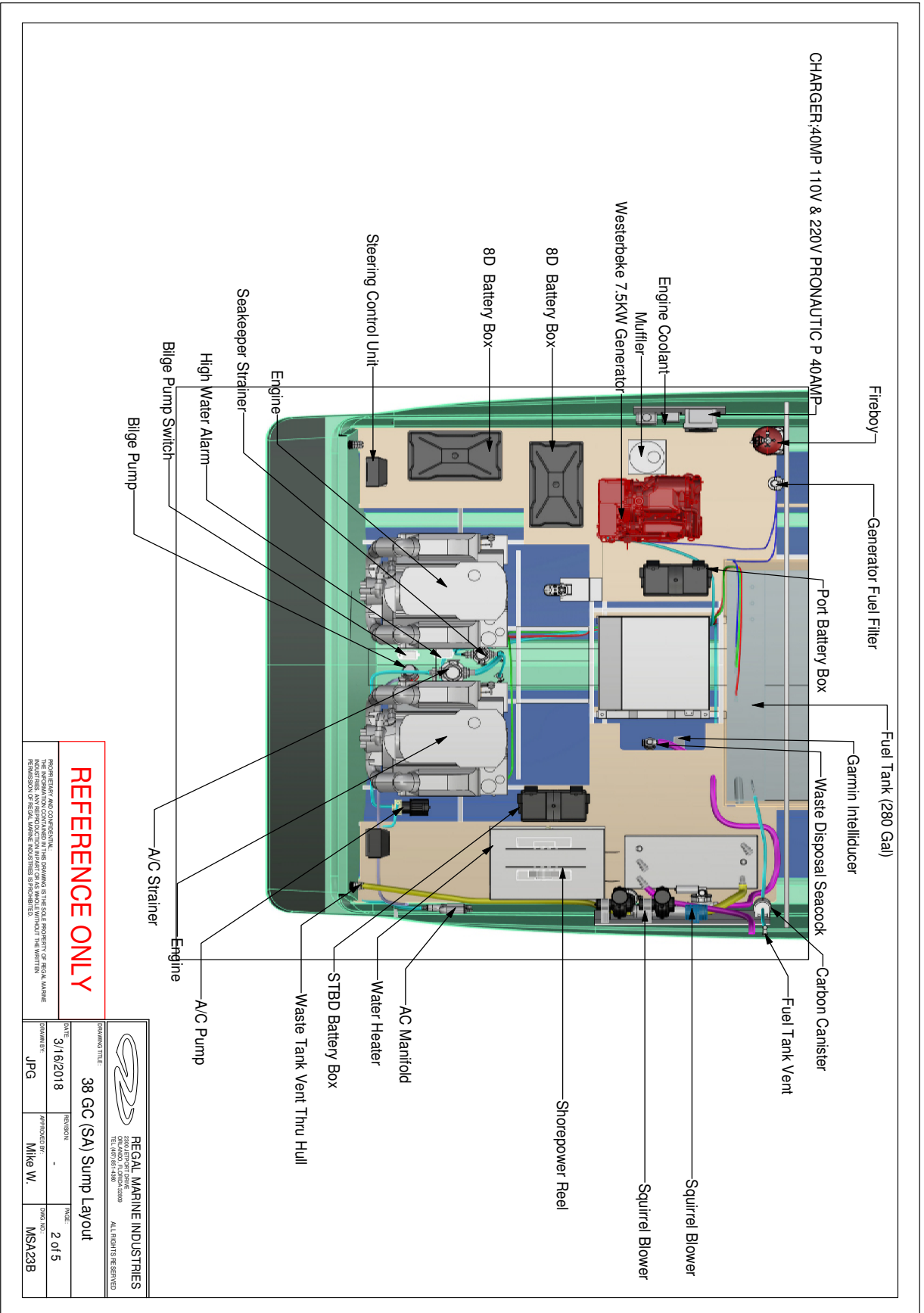

REFERENCE ONLY

PROPRIETARY AND CONFIDENTIAL. THIS DRAWING CONTAINS THE SOLE PROPERTY OF REGAL MARINE. THE INFORMATION CONTAINED IN THIS DRAWING IS TO BE USED FOR THE EXCLUSIVE USE OF THE INDIVIDUAL OR ENTITY TO WHOM IT IS ISSUED. REPRODUCTION OF THIS DRAWING WITHOUT THE WRITTEN PERMISSION OF REGAL MARINE INDUSTRIES IS PROHIBITED.

 REGAL MARINE INDUSTRIES 22001 REPORT DRIVE FORT MYERS, FL 33913 TEL: (888) 541-4800		ALL RIGHTS RESERVED	
DRAWING TITLE: 38 GC (SA) Sump Layout			
DATE:	3/15/2018	APPROVED BY:	Mike W.
DRAWN BY:	JPG	TITLE NO.:	2 of 5
		TOWER NO.:	
		MSA23B	

38GC SUMP LAYOUT 3

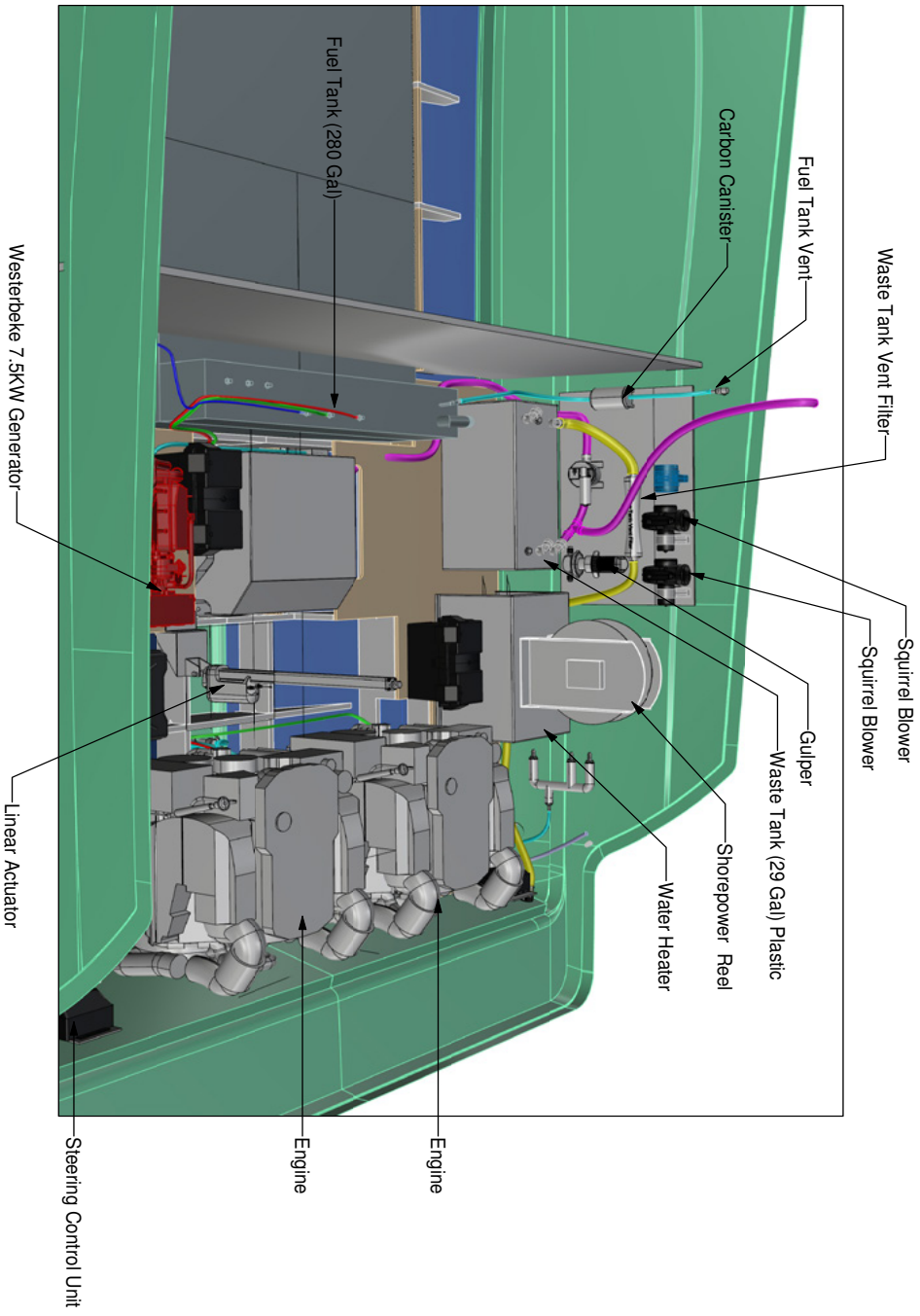

REFERENCE ONLY

PROPRIETARY AND CONFIDENTIAL. THIS INFORMATION CONTAINED IN THIS DRAWING IS THE SOLE PROPERTY OF REGAL MARINE. REPRODUCTION OR TRANSMISSION IN ANY FORM OR BY ANY MEANS WITHOUT THE WRITTEN PERMISSION OF REGAL MARINE INDUSTRIES IS PROHIBITED.

 REGAL MARINE INDUSTRIES <small>2800 AIRPORT BLVD. SUITE 2000 FT. MYERS, FL 33909 TEL: 407/531-4800</small>		<small>DATE</small> 3/16/2018		<small>REV. NO.</small> -	
<small>DRAWING TITLE</small> 38 GC (SA) Sump Layout		<small>DATE</small> 3/16/2018		<small>TRICE</small> 3 of 5	
<small>DESIGNED BY</small> JP G		<small>APPROVED BY</small> Mike W.		<small>DWG. NO.</small> MSA23B	
<small>ALL RIGHTS RESERVED</small>					

38GC SUMP LAYOUT 4

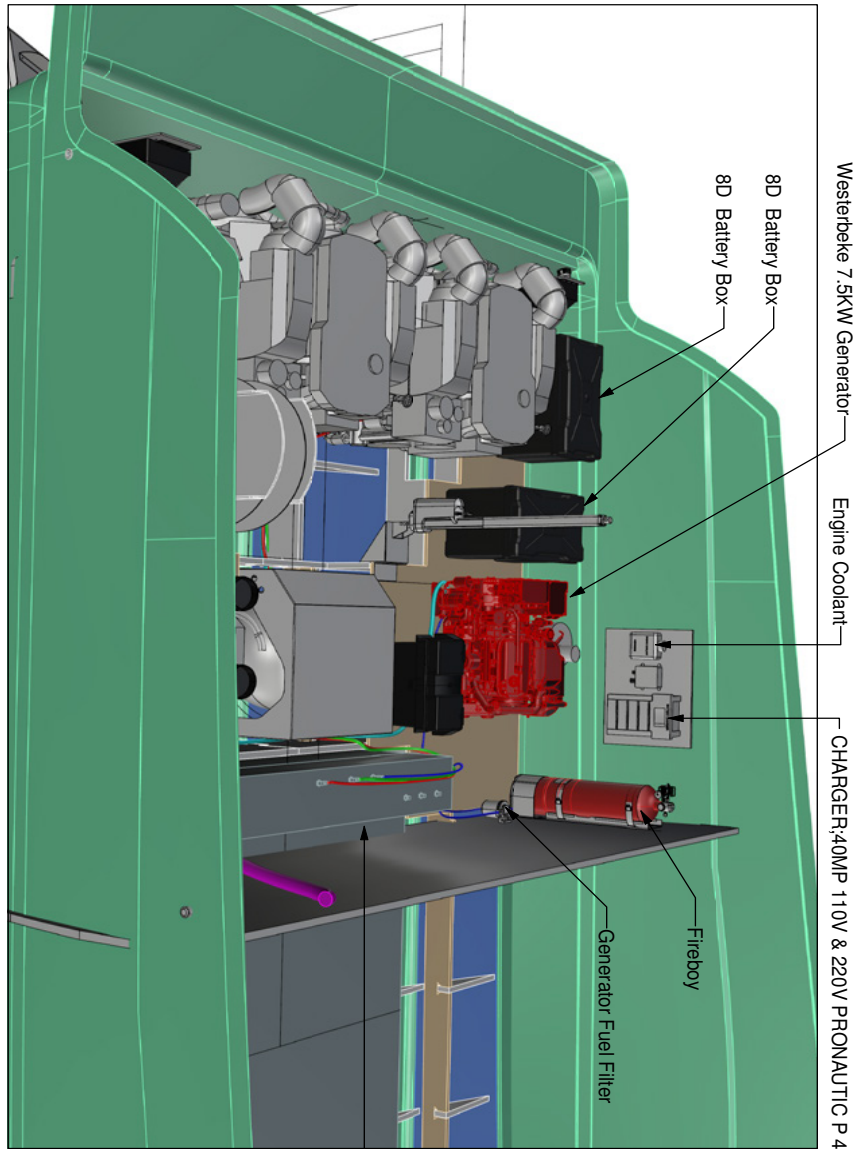

REFERENCE ONLY

PROPRIETARY AND CONFIDENTIAL.
THE INFORMATION CONTAINED IN THIS DRAWING IS THE SOLE PROPERTY OF REGAL MARINE INDUSTRIES. NO REUSE, REPRODUCTION OR TRANSMISSION OF THIS INFORMATION IS PERMITTED WITHOUT THE WRITTEN PERMISSION OF REGAL MARINE INDUSTRIES.

 REGAL MARINE INDUSTRIES 22001 SHIPYARD DRIVE FORT WORTH, TEXAS 76149 TEL: (817) 861-1490		ALL RIGHTS RESERVED	
DRAWING TITLE: 38 GC (SA) Sump Layout	DATE: 3/16/2018	REVISION: -	TRADE: 4 of 5
DRAWN BY: JPG	APPROVED BY: Mike W.	DWG. NO.: MSA23B	

38GC SUMP LAYOUT 5

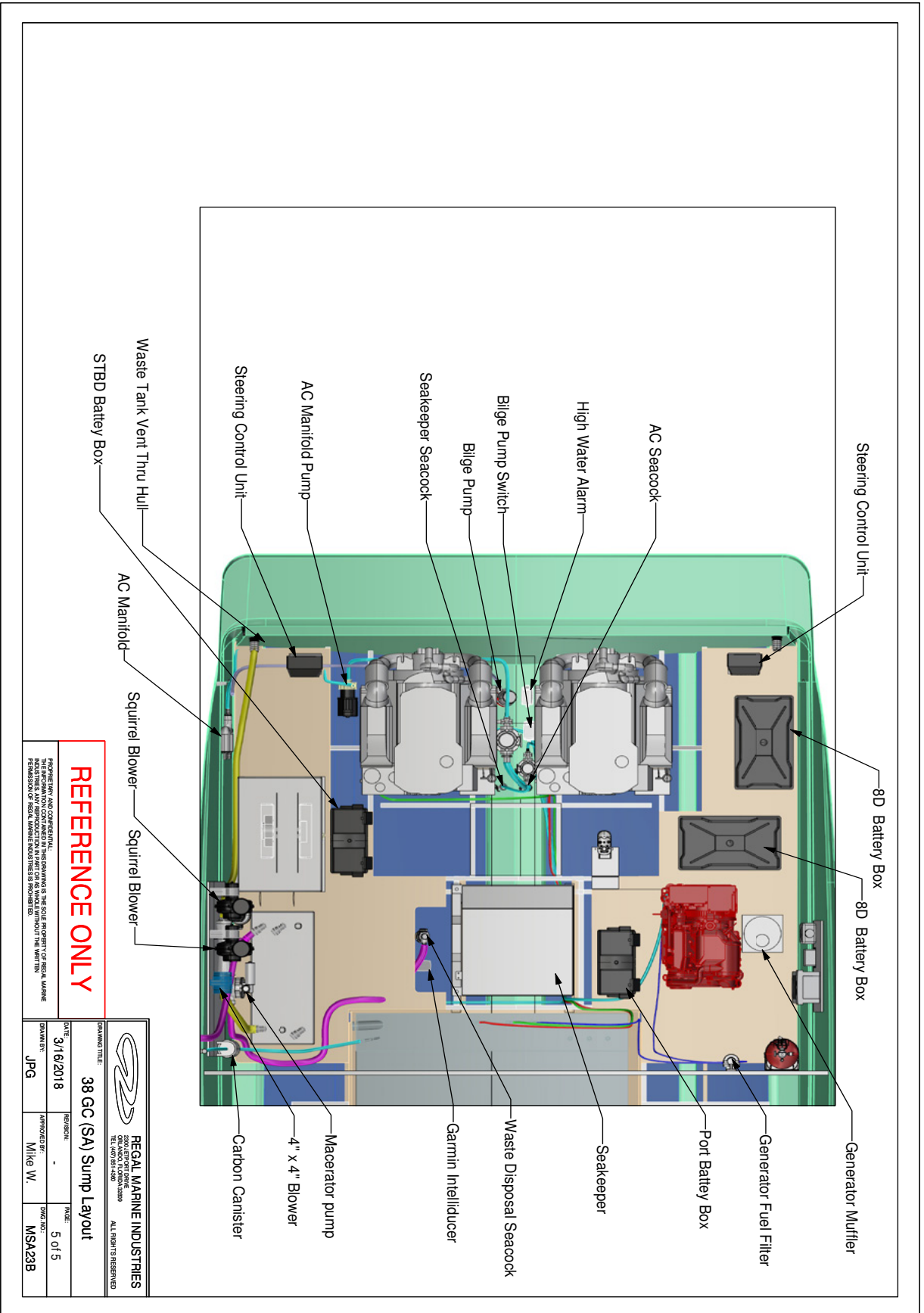

REFERENCE ONLY

PROPRIETARY AND CONFIDENTIAL. THIS INFORMATION CONTAINED HEREIN IS THE SOLE PROPERTY OF REGAL MARINE. PERMISSION TO REPRODUCE OR TRANSMIT IN ANY FORM OR BY ANY MEANS IS PROHIBITED.

 REGAL MARINE INDUSTRIES 2800 BENTLEY DRIVE FORT WORTH, TEXAS 76106 TEL: (817) 631-4800 ALL RIGHTS RESERVED	
DRAWING TITLE: 38 GC (SA) Sump Layout	
DATE: 3/16/2018	REVISION:
DRAWN BY: JPG	APPROVED BY: Mike W.
TRIAL: 5 of 5	DWG. NO.: MSA23B

38GC HULL HARDWARE 1

Bow and Transom

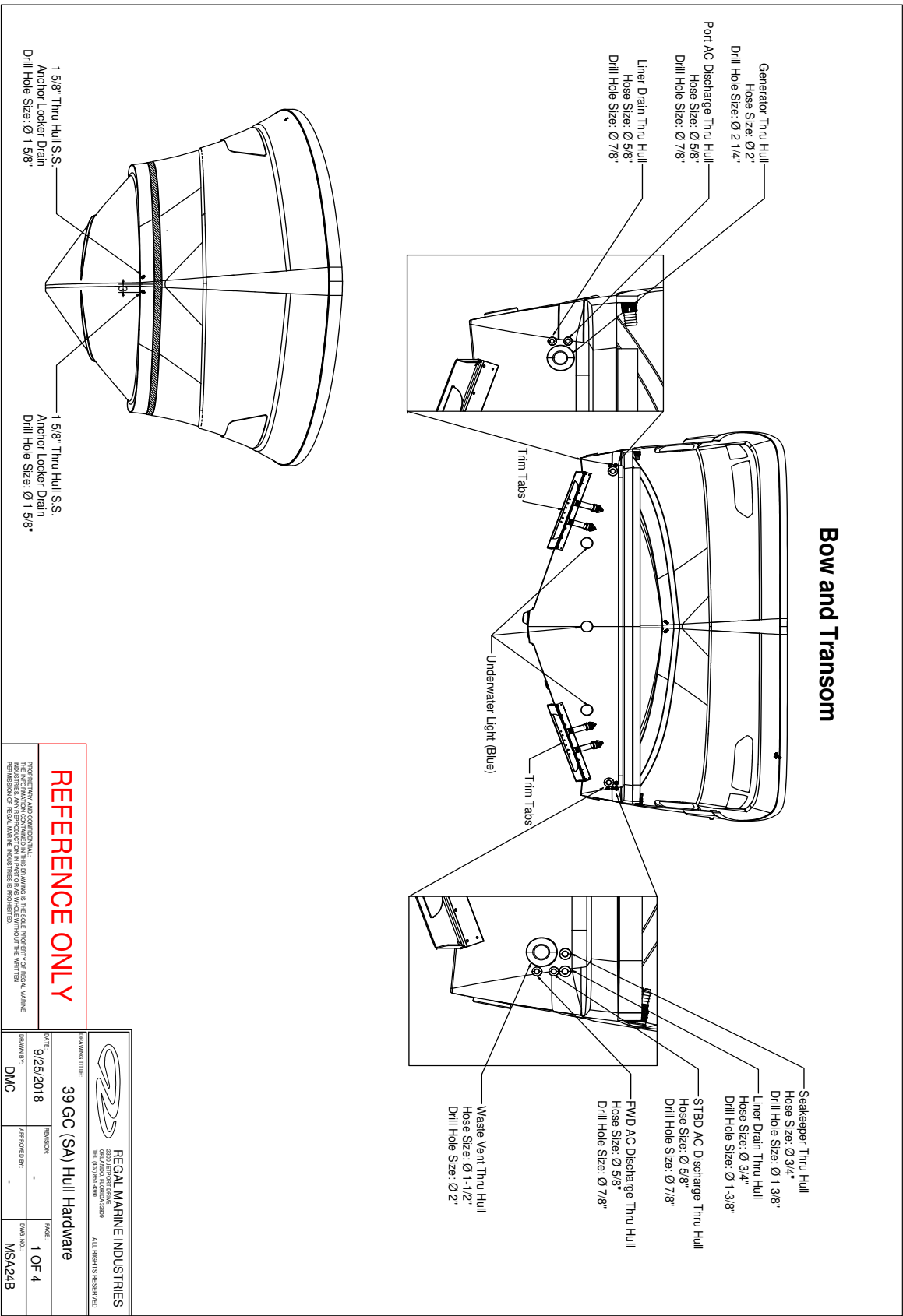

REFERENCE ONLY

PROPRIETARY AND CONFIDENTIAL.
THE INFORMATION CONTAINED IN THIS DRAWING IS THE SOLE PROPERTY OF REGAL MARINE.
REPRODUCTION OR TRANSMISSION IN ANY FORM OR BY ANY MEANS WITHOUT THE WRITTEN
PERMISSION OF REGAL MARINE INDUSTRIES IS PROHIBITED.

DRAWING TITLE		REGAL MARINE INDUSTRIES	
39 GC (SA) Hull Hardware		2500 SPORT DRIVE TEL: 407-831-4800	
DATE		APPROVED BY	
9/25/2018			
DRAWN BY		TRIAL NO.	
DMC		1 OF 4	
		MSA24B	

38GC HULL HARDWARE 2

Hull Bottom Profile

Sump View

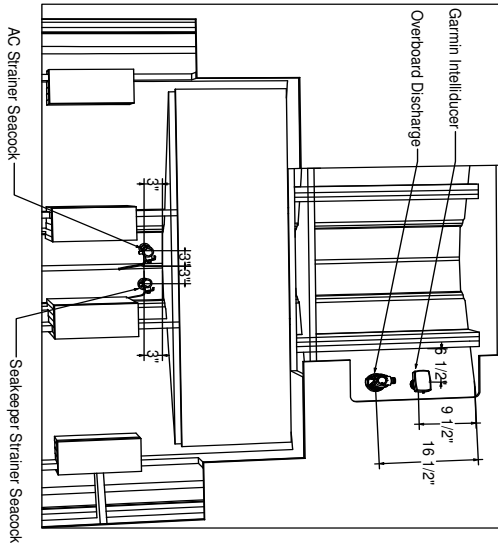

Hull Bottom

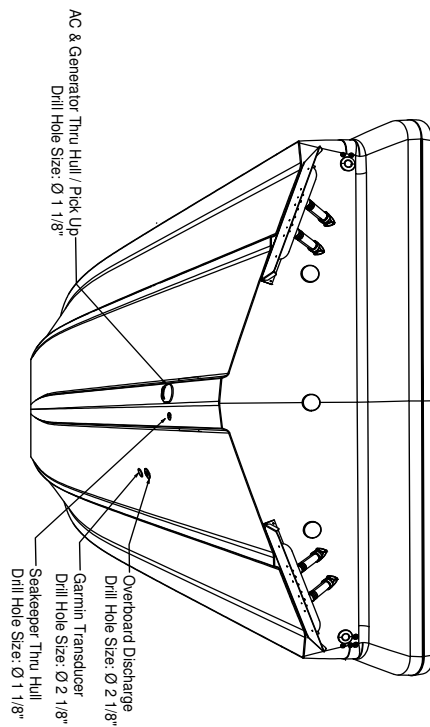

REFERENCE ONLY

REGAL MARINE INDUSTRIES
 2500 SHIPYARD DRIVE
 FORT WORTH, TEXAS 76140
 TEL: (817) 440-8800
 WWW.REGALMARINE.COM
 THE INFORMATION CONTAINED IN THIS DRAWING IS THE SOLE PROPERTY OF REGAL MARINE INDUSTRIES. NO REPRODUCTION OR TRANSMISSION OF THIS INFORMATION IS PERMITTED WITHOUT THE WRITTEN PERMISSION OF REGAL MARINE INDUSTRIES.

 REGAL MARINE INDUSTRIES 2500 SHIPYARD DRIVE FORT WORTH, TEXAS 76140 TEL: (817) 440-8800 WWW.REGALMARINE.COM ALL RIGHTS RESERVED	
DRAWING TITLE	39 GC (SA) Hull Hardware
DATE	9/25/2018
DESIGNED BY	DMC
APPROVED BY	-
TRIALS	2 OF 4
WORK NO.	MSA24B

38GC HULL HARDWARE 3

STBD Side

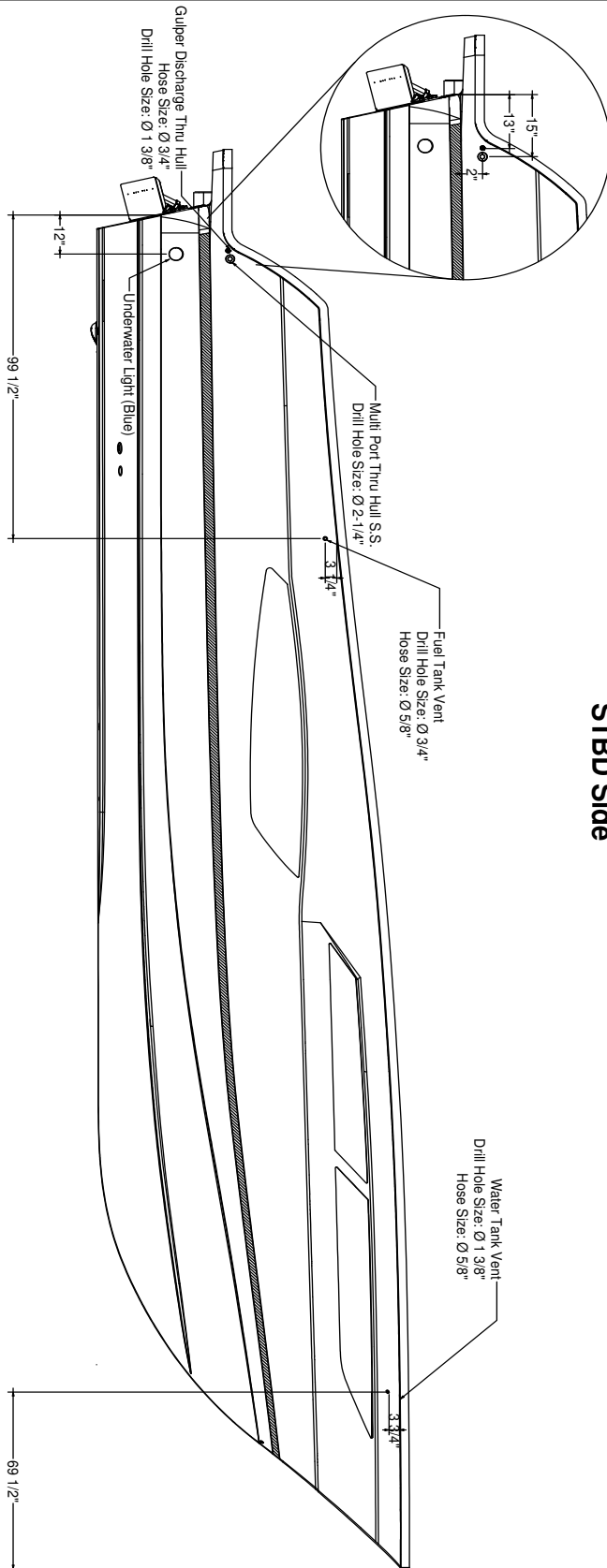

REFERENCE ONLY

PROPRIETARY AND CONFIDENTIAL.
THE INFORMATION CONTAINED IN THIS DRAWING IS THE SOLE PROPERTY OF REGAL MARINE.
REPRODUCTION OR TRANSMISSION IN ANY FORM OR BY ANY MEANS WITHOUT THE WRITTEN
PERMISSION OF REGAL MARINE INDUSTRIES IS PROHIBITED.

 REGAL MARINE INDUSTRIES 2200 IMPERIAL TRAIL FORT WORTH, TEXAS 76116 TEL: (817) 851-4400		ALL RIGHTS RESERVED	
DRAWING TITLE	39 GC (SA) Hull Hardware		
DATE	9/25/2018	REVISION	-
DRAWN BY	DMC	APPROVED BY	-
SCALE	3 OF 4		
TRIAL NO.	MSA24B		

38GC HULL HARDWARE 4

Port Side

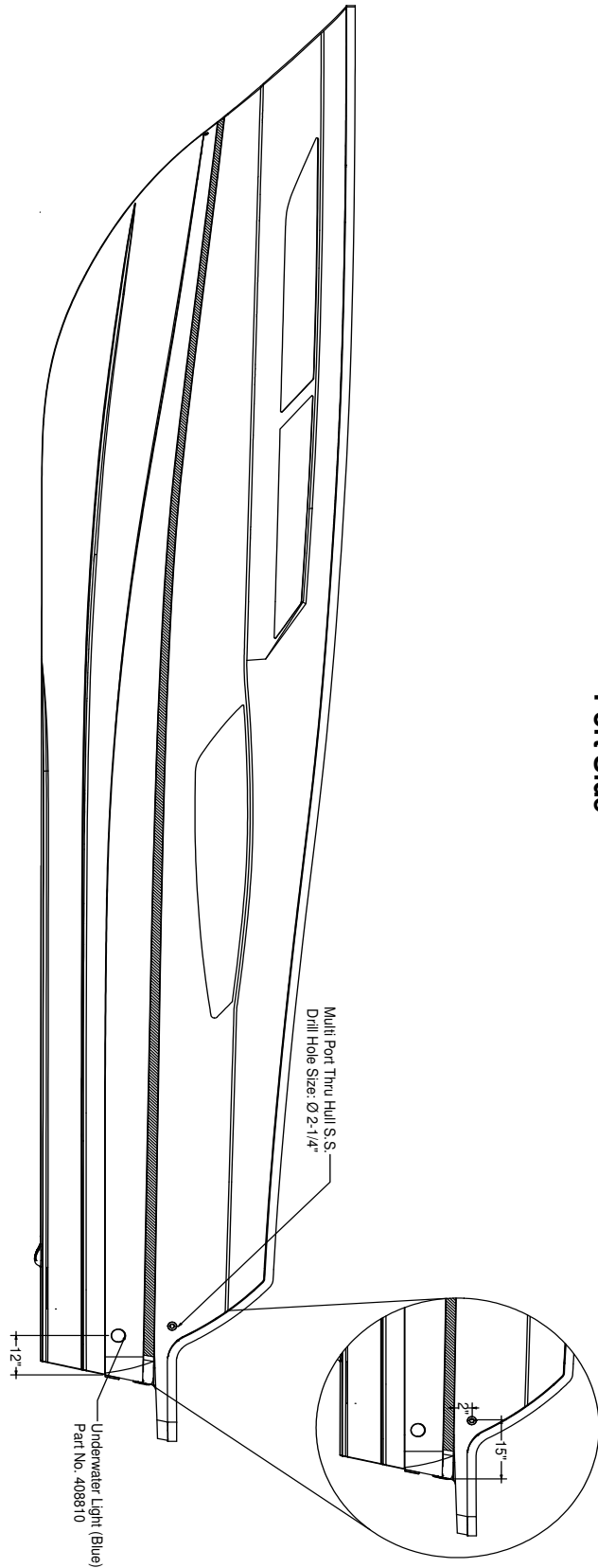

REFERENCE ONLY

REGAL MARINE INDUSTRIES
 2300 JEFFERSON DRIVE
 WILMINGTON, DE 19806
 TEL: (302) 861-4800
 WWW.REGALMARINE.COM

 REGAL MARINE INDUSTRIES 2300 JEFFERSON DRIVE WILMINGTON, DE 19806 TEL: (302) 861-4800 WWW.REGALMARINE.COM ALL RIGHTS RESERVED			
DRAWING TITLE	39 GC (SA) Hull Hardware		
DATE	REVISION	PRICE	
9/25/2018	-	4 OF 4	
DRAWN BY	APPROVED BY	DWG. NO.	
DMC	-	MSA24B	

38GC DECK HARDWARE 1

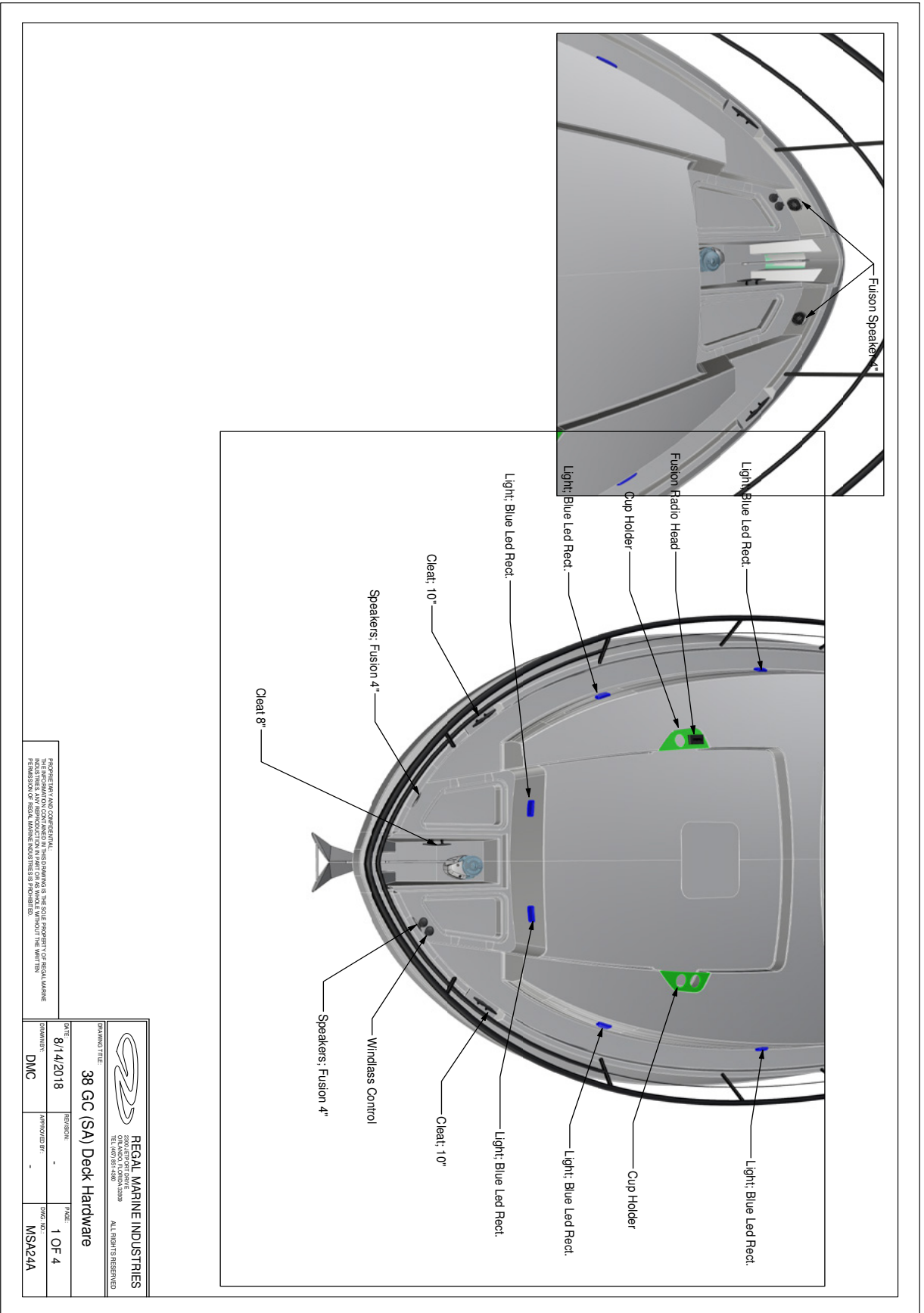

PROPRIETARY AND CONFIDENTIAL.
 THIS INFORMATION CONTAINED IN THIS DRAWING IS THE SOLE PROPERTY OF REGAL MARINE
 INDUSTRIES. ANY REUSE, REPRODUCTION, OR DISTRIBUTION OF THIS INFORMATION WITHOUT THE
 PERMISSION OF REGAL MARINE INDUSTRIES IS PROHIBITED.

 REGAL MARINE INDUSTRIES 25001 IMPERIAL DRIVE FORT WORTH, TEXAS 76149 TEL: (817) 851-4400 FAX: (817) 851-4401 ALL RIGHTS RESERVED	
DRAWING TITLE	
38 GC (SA) Deck Hardware	
DATE	REVISION
8/14/2018	-
DRAWN BY	APPROVED BY
DMC	-
PAGE NO.	
1 OF 4	
DWG. NO.	
MSA24A	

38GC DECK HARDWARE 2

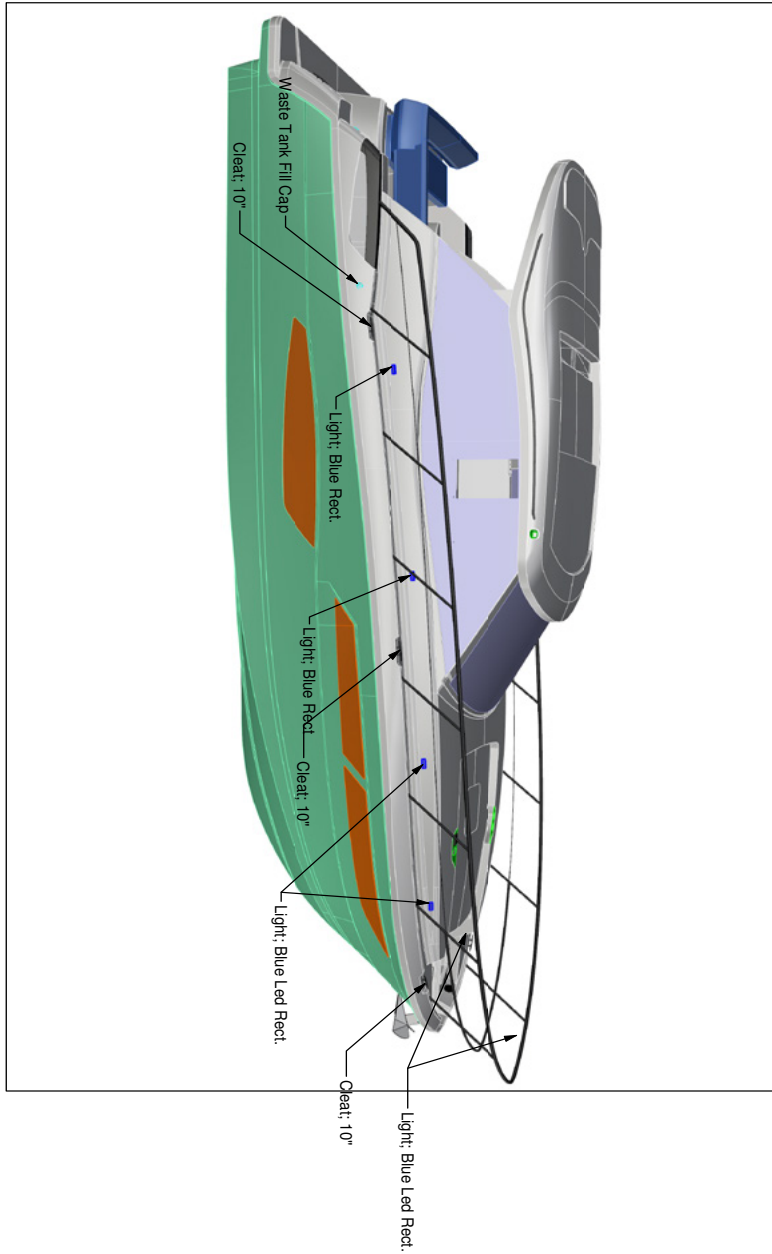

PROPRIETARY AND CONFIDENTIAL.
 THE INFORMATION CONTAINED IN THIS DRAWING IS THE SOLE PROPERTY OF REGAL MARINE
 INDUSTRIES. ANY REUSE, REPRODUCTION, OR DISTRIBUTION OF THIS INFORMATION WITHOUT THE
 PERMISSION OF REGAL MARINE INDUSTRIES IS PROHIBITED.

 REGAL MARINE INDUSTRIES 25501 IMPERIAL TRAIL FORT MYERS, FL 33907 TEL: (888) 868-4460		ALL RIGHTS RESERVED	
DRAWING TITLE 38 GC (SA) Deck Hardware	DATE 8/14/2018	REVISION -	TRACE 2 OF 4
DRAWN BY DMC	APPROVED BY -	DWG. NO. MSA24A	

38GC DECK HARDWARE 3

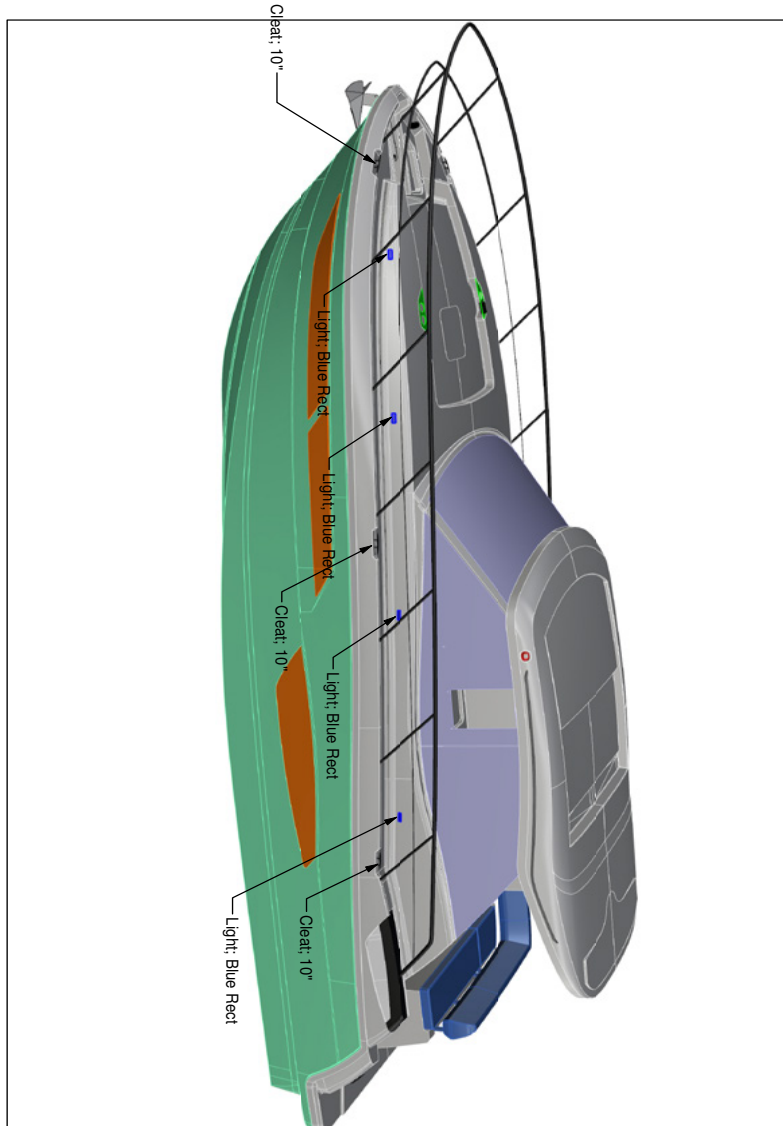

PROPRIETARY AND CONFIDENTIAL.
 THE INFORMATION CONTAINED IN THIS DRAWING IS THE SOLE PROPERTY OF REGAL MARINE
 INDUSTRIES. ANY REUSE, REPRODUCTION, OR DISTRIBUTION OF THIS DRAWING WITHOUT THE
 PERMISSION OF REGAL MARINE INDUSTRIES IS PROHIBITED.

 REGAL MARINE INDUSTRIES 25501 IMPERIAL DRIVE FORT MYERS, FL 33907 TEL: 888.648.6800		ALL RIGHTS RESERVED	
DRAWING TITLE: 38 GC (SA) Deck Hardware			
DATE:	8/14/2018	REVISION:	
DRAWN BY:	DMC	APPROVED BY:	
SCALE:		TRAIL:	3 OF 4
		DWG. NO.:	MSA24A

Notice

THE DRAWINGS FOLLOWING IN THIS SECTION MORE SPECIFICALLY
MATCH THE 38XO OUTBOARD VESSEL.

38XO PROFILE

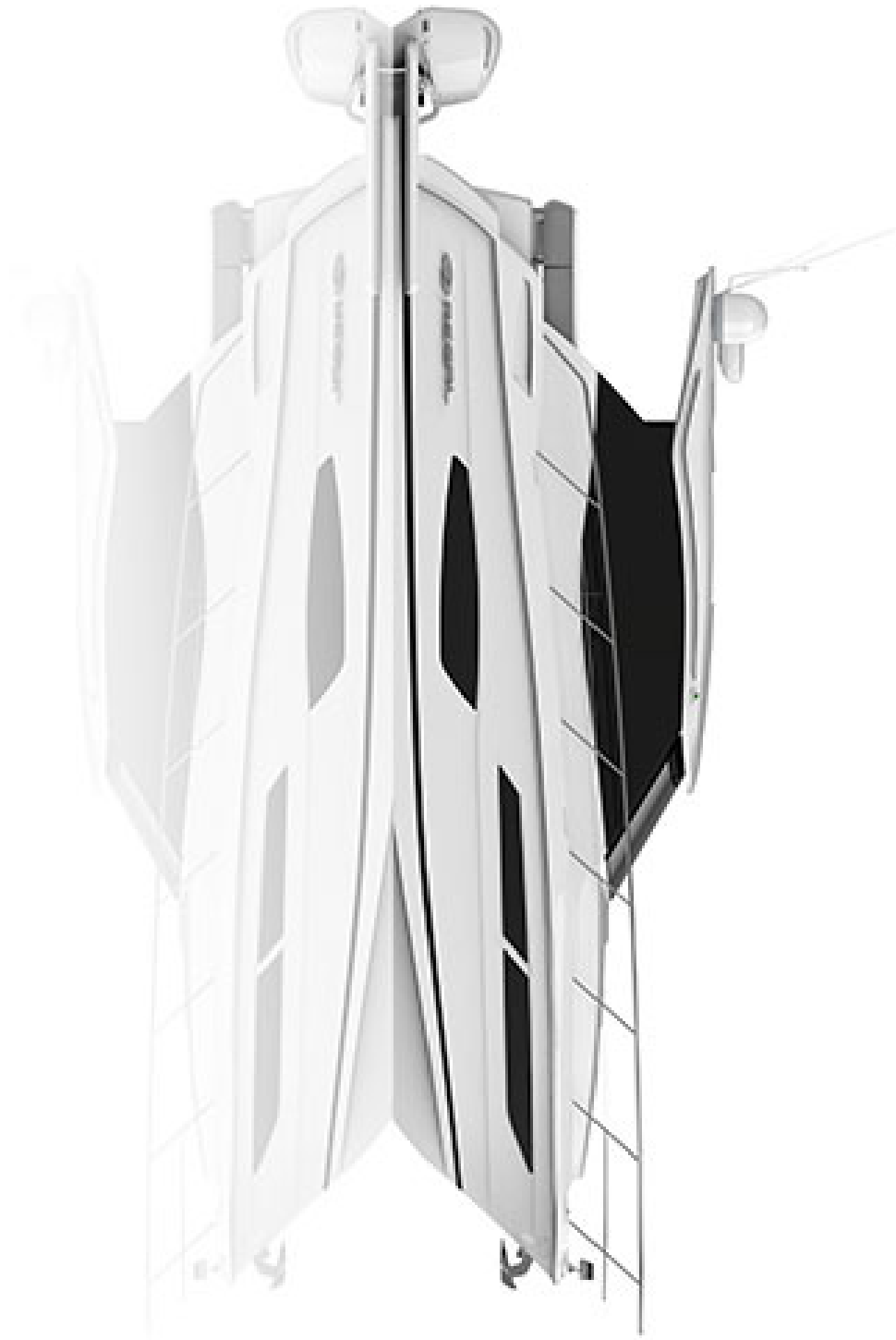

38XO TOP VIEW-SALON & PATIO



38XO TOP VIEW-INTERIOR



38XO HORIZONTAL RANGE OF VISIBILITY

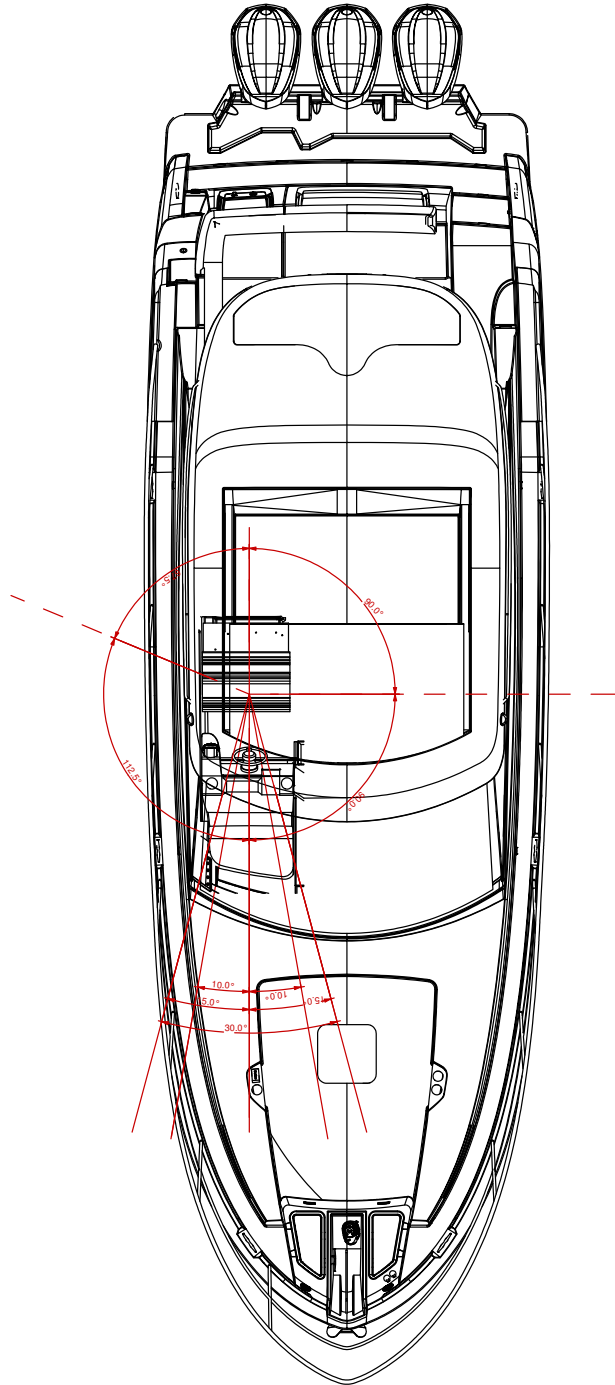

REFERENCE ONLY

PROVIDE DATA AND COMMENTS.
 THE INFORMATION CONTAINED IN THIS DRAWING IS THE SOLE PROPERTY OF REGAL MARINE INDUSTRIES. IT IS TO BE USED FOR THE SPECIFIC PROJECT AND SHALL BE VOID IF THE INFORMATION IS REPRODUCED OR TRANSMITTED IN ANY FORM OR BY ANY MEANS, WITHOUT THE WRITTEN PERMISSION OF REGAL MARINE INDUSTRIES IS PROHIBITED.

 REGAL MARINE INDUSTRIES 10000 W. FLORIDA AVE. #800 FORT MYERS, FL 33907-4800		ALL RIGHTS RESERVED	
38 GC (SB) Horizontal Range of Visibility			
DATE:	2/18/2019	DESIGNER:	
DRAWN BY:	DMC	APPROVED BY:	
		SCALE:	1 OF 2
		TOTAL NO.:	5

38XO VERTICAL RANGE OF VISIBILITY

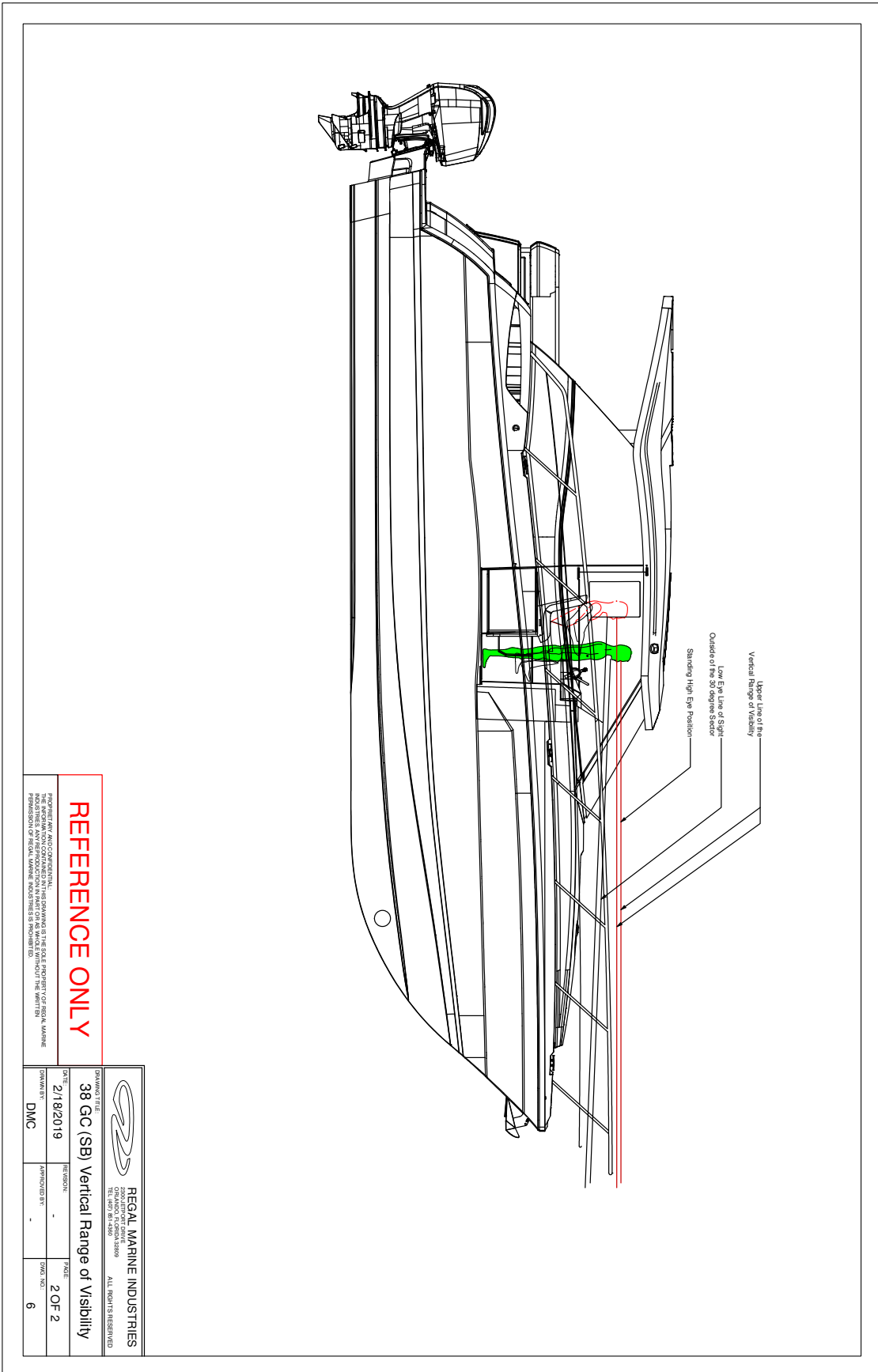

REFERENCE ONLY

REGAL MARINE INDUSTRIES
THE INFORMATION CONTAINED IN THIS DRAWING IS THE SOLE PROPERTY OF REGAL MARINE
INDUSTRIES. IT IS TO BE USED ONLY FOR THE PROJECT AND FOR THE SPECIFIC PURPOSES
FOR WHICH IT IS PROVIDED. NO PART OF THIS DRAWING IS TO BE REPRODUCED OR
TRANSMITTED IN ANY FORM OR BY ANY MEANS, ELECTRONIC OR MECHANICAL, WITHOUT
PERMISSION OF REGAL MARINE INDUSTRIES IS PROHIBITED.

 REGAL MARINE INDUSTRIES <small>20000 10th Avenue S.E. Everett, WA 98203 TEL: (425) 371-4400</small>		<small>ALL RIGHTS RESERVED</small>	
<small>DRAWING TITLE</small> 38 GC (SB) Vertical Range of Visibility			
<small>DATE</small> 2/18/2019		<small>REVISED BY</small> -	
<small>DRAWN BY</small> DMC		<small>DATE</small> 2 OF 2	
		<small>TOTAL NO.</small> 6	

38XO SEATING OCCUPANCY

15.5" W X 29.5" L
Allowance Per Person

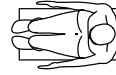

SEATING OCCUPANCY: 11 PERSONS

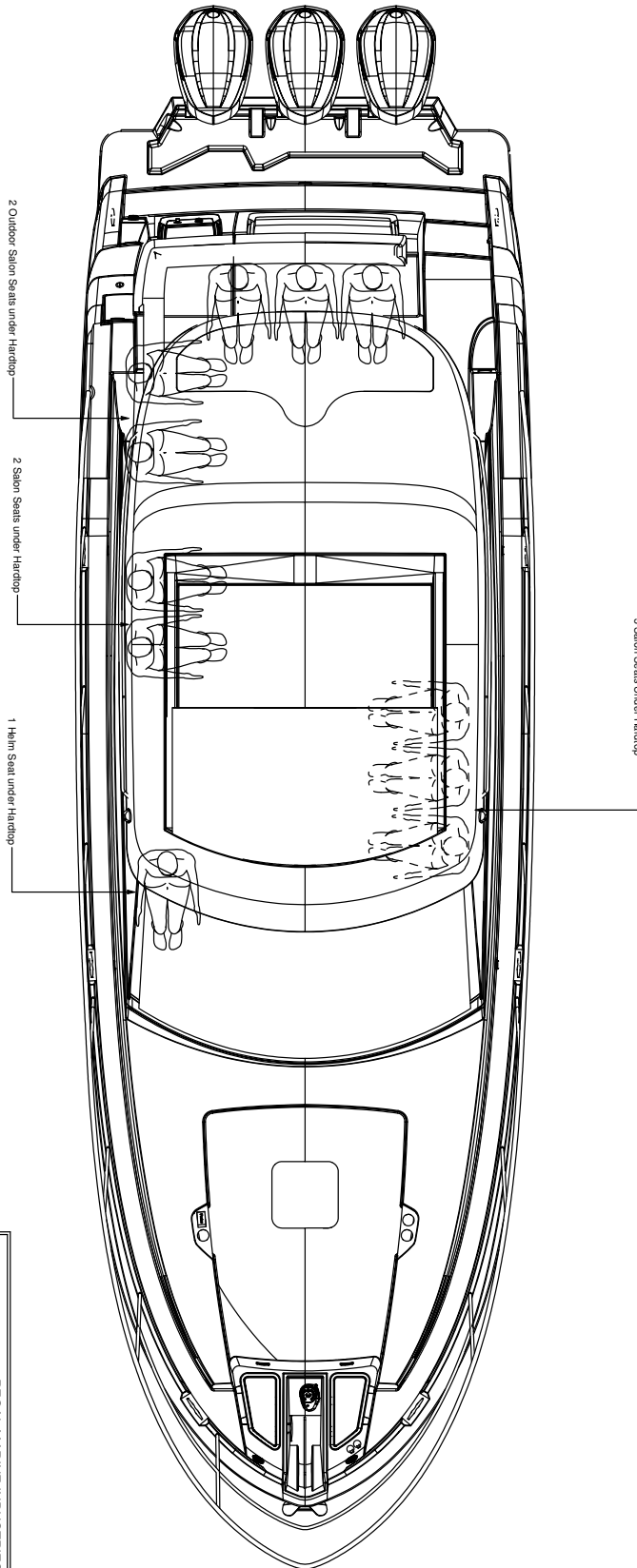

REGAL MARINE INDUSTRIES
THE INFORMATION CONTAINED IN THIS DRAWING IS THE SOLE PROPERTY OF REGAL MARINE
INDUSTRIES. IT IS TO BE USED FOR THE SPECIFIC PROJECT AND NO OTHER PROJECTS.
PERMISSION OF REGAL MARINE INDUSTRIES IS REQUIRED TO REPRODUCE THIS DRAWING.

 REGAL MARINE INDUSTRIES 2000 W. STATE ST. SUITE 100 FORT WORTH, TEXAS 76102 TEL: 817.781.4800		ALL RIGHTS RESERVED	
DRAWING TITLE 38 GC (SB) Seating Capacity			
DATE	REVISION	SCALE	TRAILER
2/7/2019	*		1 OF 1
DRAWN BY	APPROVED BY	DATE	TRAILER NO.
DMC	Dennis R.		7

38XO SUMP LAYOUT 1

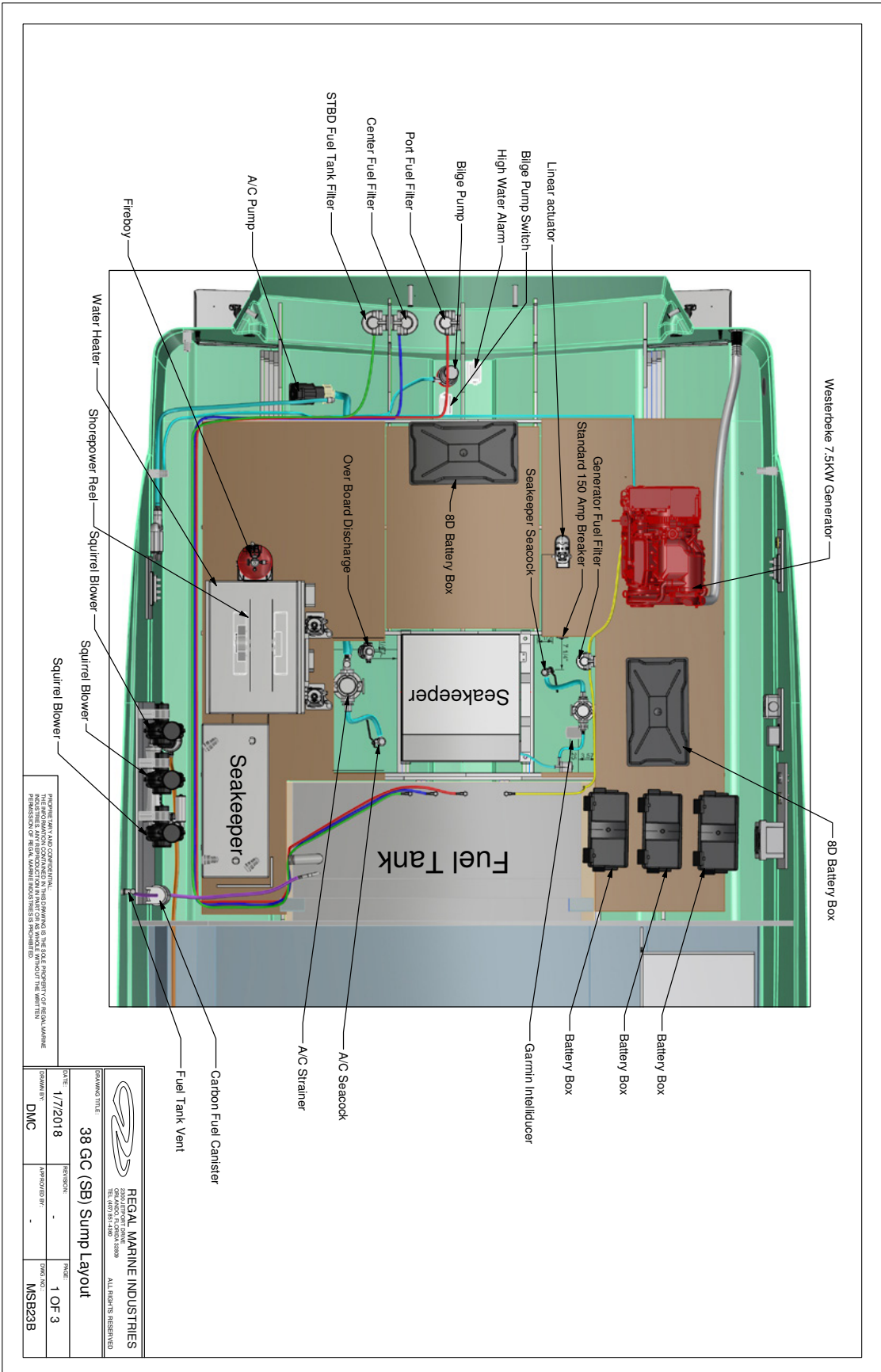

38XO SUMP LAYOUT 2

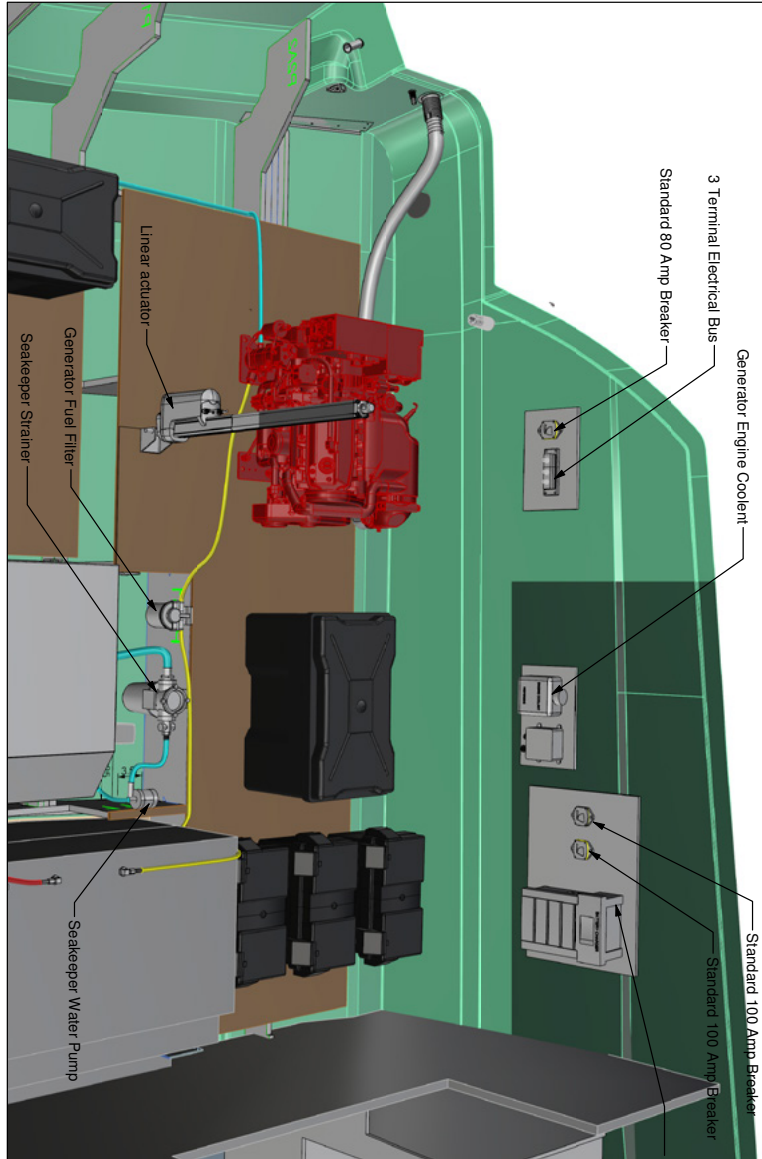

REGAL MARINE AND COMMERCIAL
 REGAL MARINE INDUSTRIES
 2500 W. 10TH AVE. SUITE 100
 DENVER, CO 80202
 TEL: 303.733.8888 FAX: 303.733.8889
 WWW.REGALMARINE.COM
 ALL RIGHTS RESERVED

 REGAL MARINE INDUSTRIES 2500 W. 10TH AVE. SUITE 100 DENVER, CO 80202 TEL: 303.733.8888 FAX: 303.733.8889 WWW.REGALMARINE.COM ALL RIGHTS RESERVED			
DRAWING TITLE	38 GC (SB) Sump Layout		
DATE	1/7/2018	REVISION	PAGE 2 OF 3
DRAWN BY	DMC	APPROVED BY	MSB23B

38XO SUMP LAYOUT 3

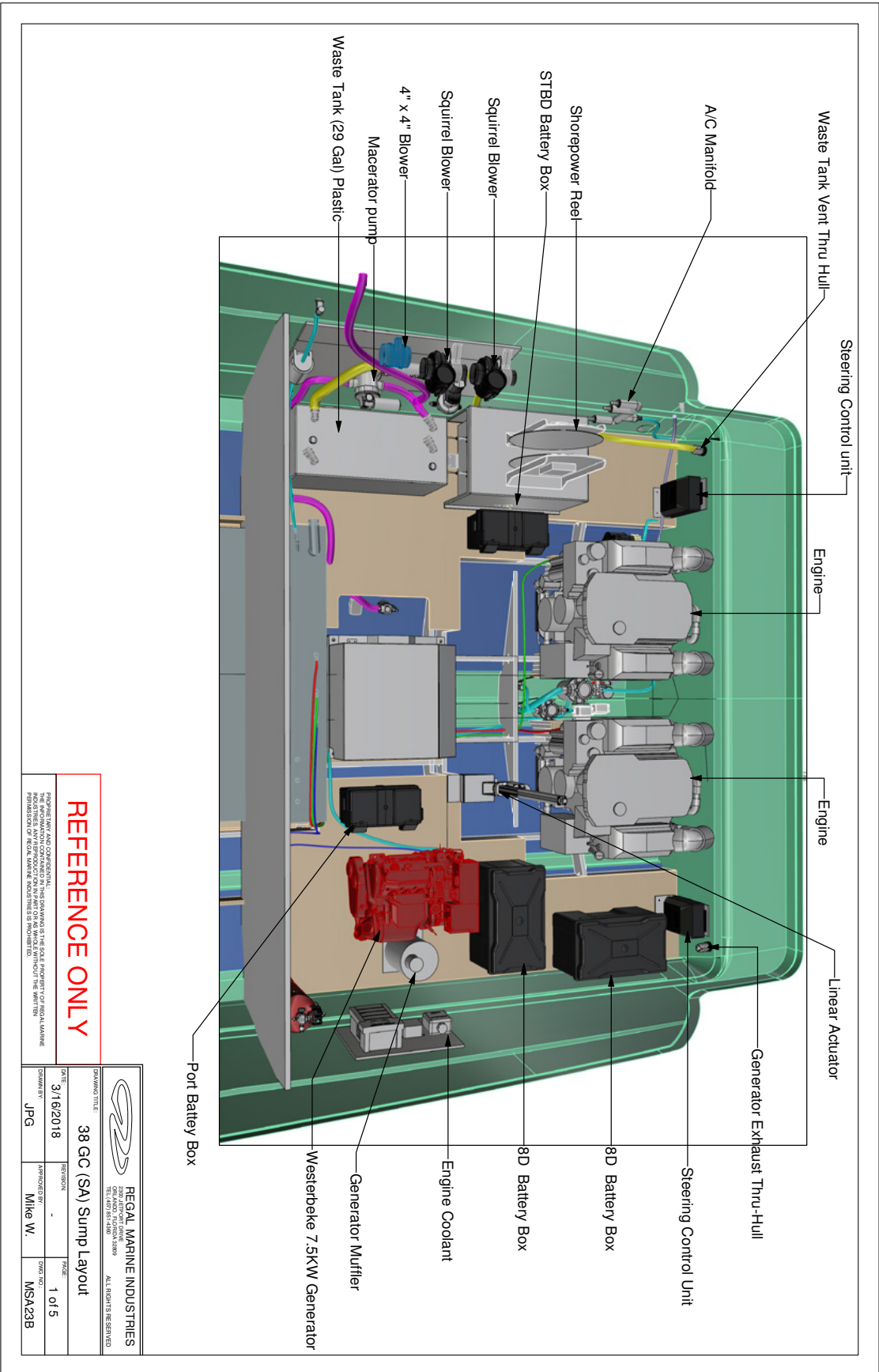

REFERENCE ONLY

REGAL MARINE INDUSTRIES
 38XO SUMP LAYOUT 3
 THE INFORMATION CONTAINED IN THIS DRAWING IS THE SOLE PROPERTY OF REGAL MARINE INDUSTRIES. NO PART OF THIS DRAWING IS TO BE REPRODUCED OR TRANSMITTED IN ANY FORM OR BY ANY MEANS, ELECTRONIC OR MECHANICAL, INCLUDING PHOTOCOPYING, RECORDING, OR BY ANY INFORMATION STORAGE AND RETRIEVAL SYSTEM, WITHOUT THE WRITTEN PERMISSION OF REGAL MARINE INDUSTRIES.

 REGAL MARINE INDUSTRIES 2001 W. STATE ST. SUITE 100 TAMPA, FL 33606 TEL: (813) 848-1000		ALL RIGHTS RESERVED	
DRAWING TITLE 38 GC (SA) Sump Layout	DATE 3/16/2018	REVISION -	DRAWING NO. MSA23B
DRAWING BY JPG	APPROVED BY Mike W.	SCALE 1 of 5	SHEET NO. MSA23B

38XO HULL HARDWARE 1

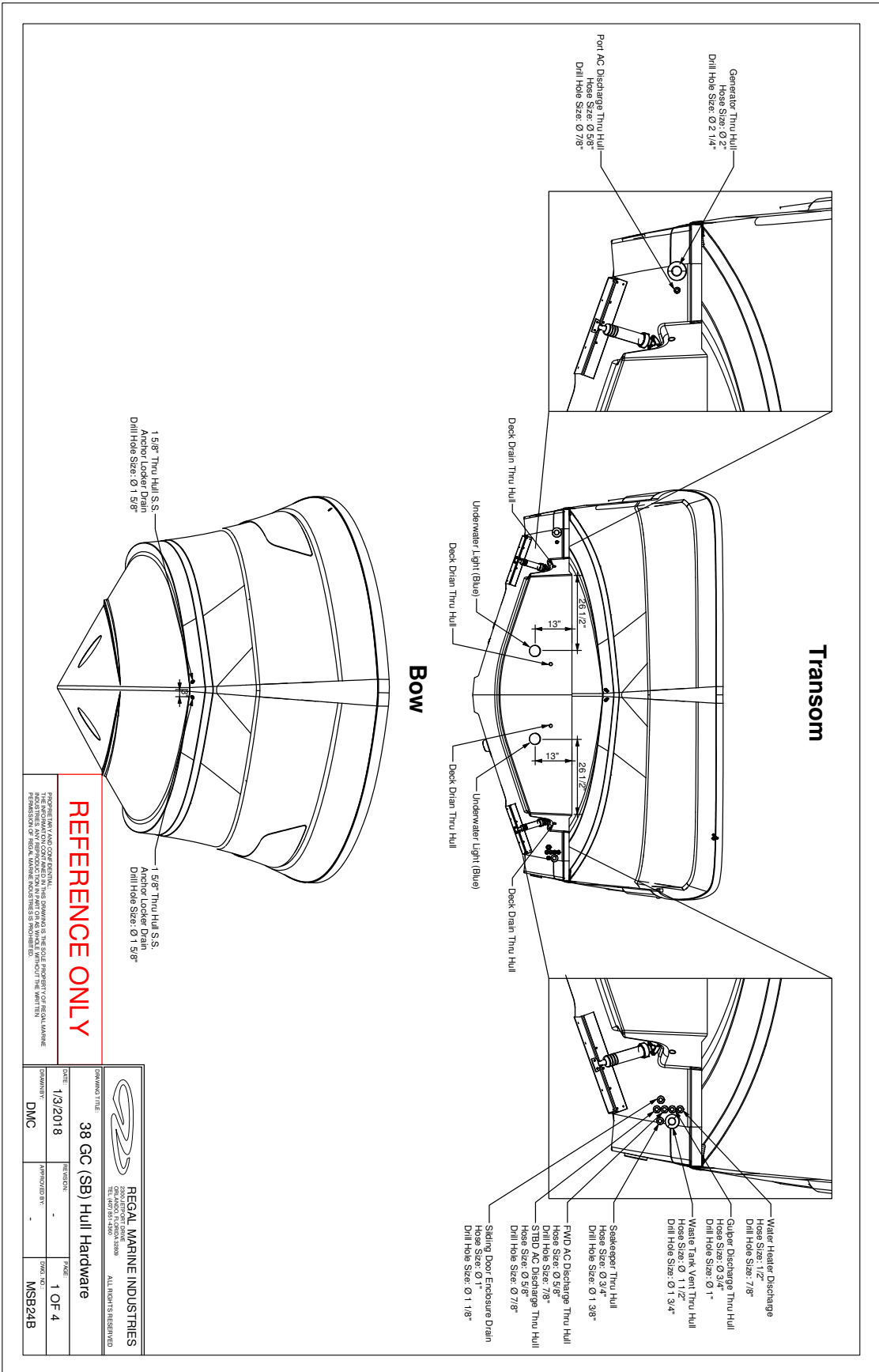

38XO HULL HARDWARE 2

Hull Bottom Profile

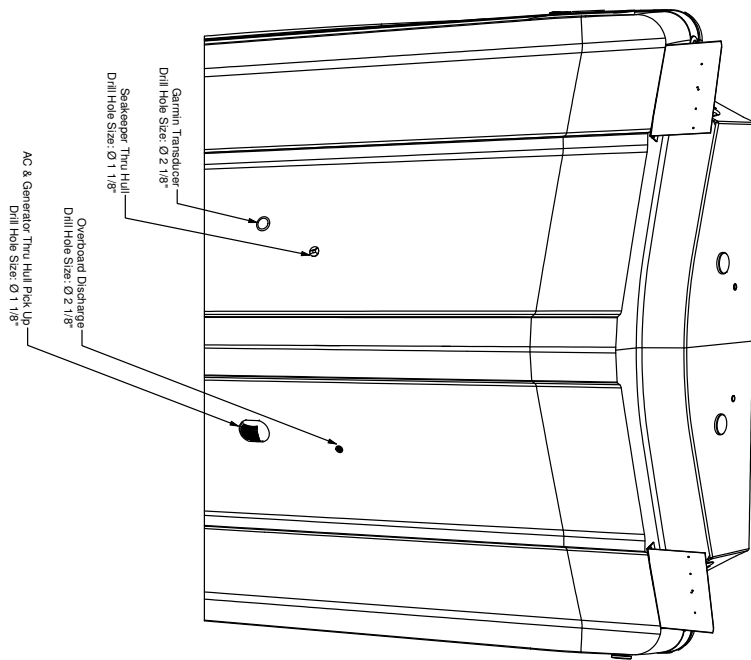
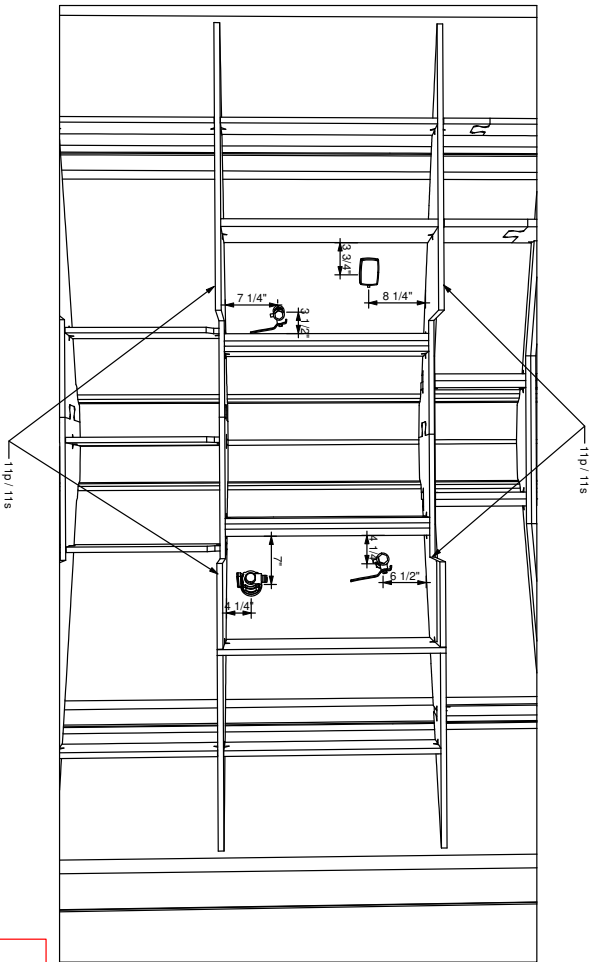

REFERENCE ONLY

PROPRIETARY AND CONFIDENTIAL. THIS INFORMATION CONTAINED HEREIN IS THE SOLE PROPERTY OF REGAL MARINE INDUSTRIES AND IS TO BE KEPT IN STRICTLY CONFIDENTIAL. PERMISSION IS GRANTED TO MAKE COPIES OF THIS DRAWING FOR PERSONAL USE ONLY.

 REGAL MARINE INDUSTRIES <small>OSHTAMO BLDG. 1000 TEL: 407-928-4400</small>		ALL RIGHTS RESERVED	
DRAWING TITLE: 38 GC (SB) Hull Hardware			
DATE:	1/3/2018	REVISION:	-
DRAWN BY:	DMC	APPROVED BY:	-
DRAWING NO.: MSA24B		PAGE NO.: 2 OF 4	

38XO HULL HARDWARE 3

STBD Side

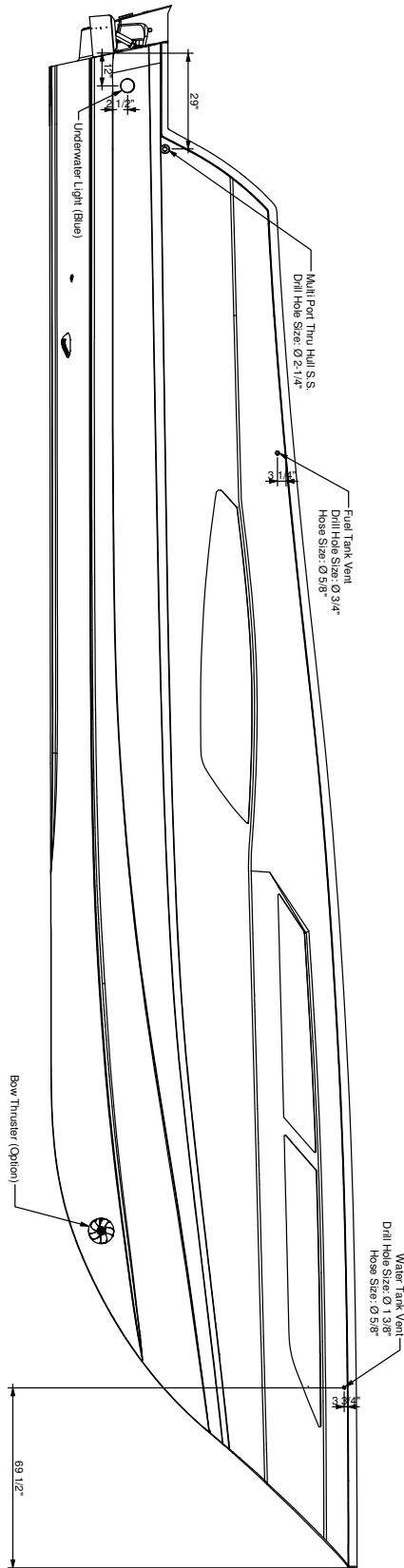

REFERENCE ONLY

REGAL MARINE INDUSTRIES
 200 W. 10th Street, Suite 100
 St. Louis, MO 63102
 TEL: (314) 781-4800
 FAX: (314) 781-4801
 WWW.REGALMARINE.COM

 REGAL MARINE INDUSTRIES 200 W. 10th Street, Suite 100 St. Louis, MO 63102 TEL: (314) 781-4800 FAX: (314) 781-4801 WWW.REGALMARINE.COM ALL RIGHTS RESERVED	
DRAWING TITLE	
38 GC (SB) Hull Hardware	
DATE	REVISION
1/3/2018	-
DRAWN BY	APPROVED BY
DMC	-
PAGE	
3 OF 4	
DRAWING NO.	
MSB24B	

38XO HULL HARDWARE 4

Port Side



REFERENCE ONLY

REGAL MARINE INDUSTRIES AND COMPANIES, INC. MAKES NO WARRANTY, REPRESENTATION OR GUARANTEE IN THIS DRAWING. THE SOLE PROPERTY OF REGAL MARINE INDUSTRIES, ANY REPRODUCTION IN PART OR IN WHOLE WITHOUT THE WRITTEN PERMISSION OF REGAL MARINE INDUSTRIES, INC. IS PROHIBITED.

 REGAL MARINE INDUSTRIES 2000 W. BAYVIEW BLVD. SUITE 100 TAMPA, FL 33613 TEL: (813) 942-4989		ALL RIGHTS RESERVED	
DRAWING TITLE			
38 GC (SB) Hull Hardware			
DATE	REVISION	SCALE	
1/3/2018	-	4 OF 4	
DRAWN BY	APPROVED BY	TRIAL NO.	
DMC	-	MSB24B	

38XO DECK HARDWARE

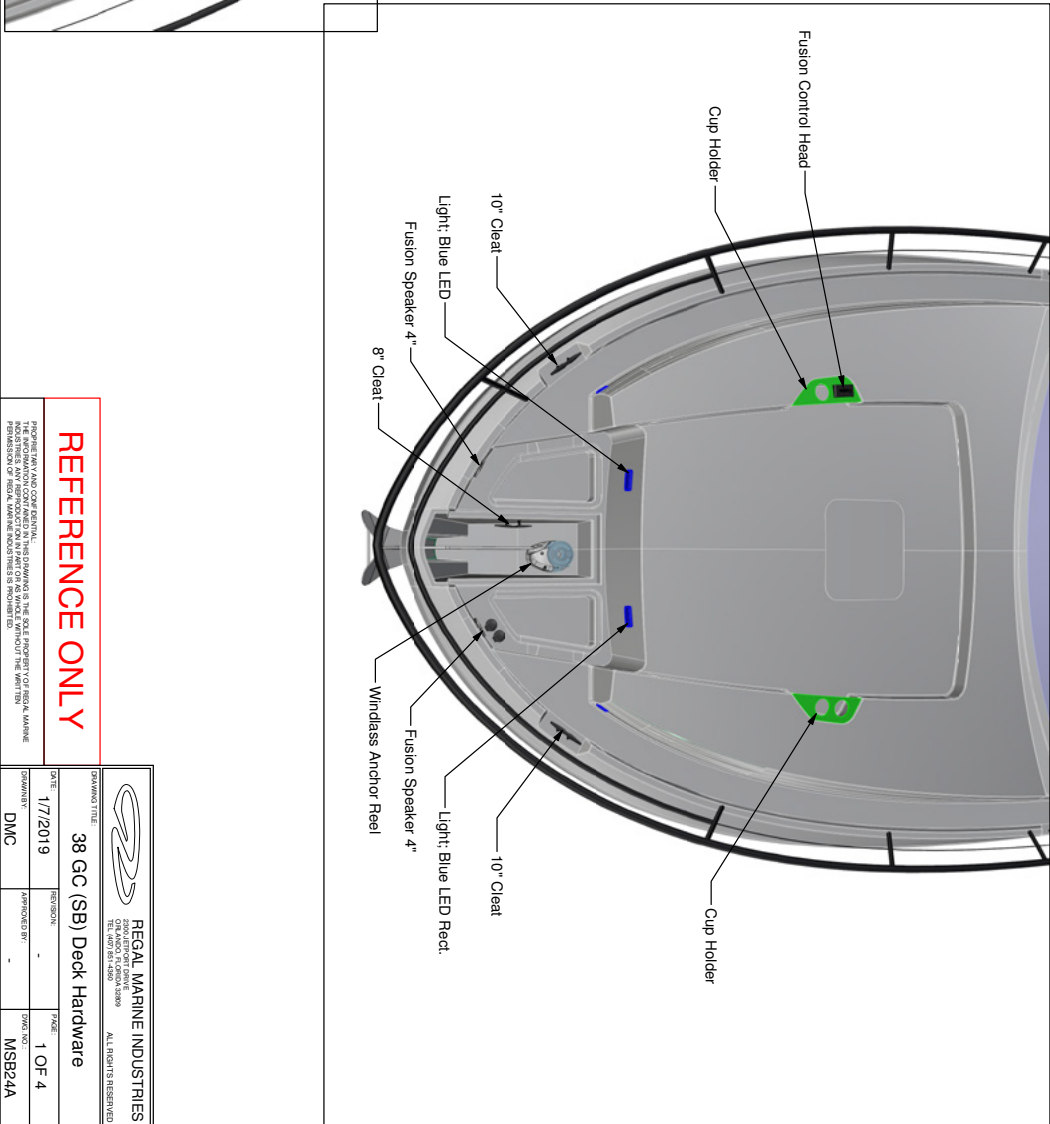
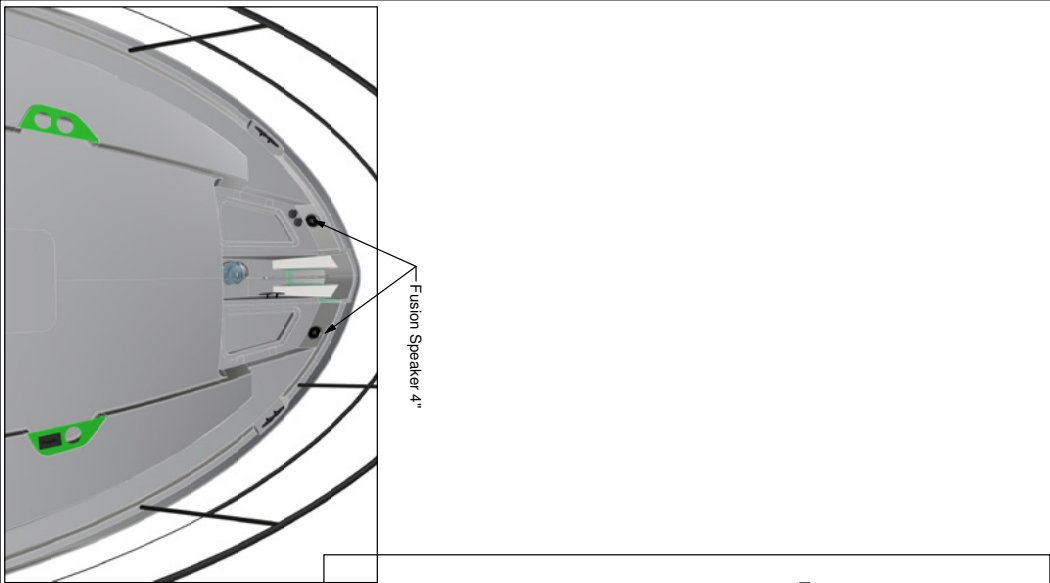

REFERENCE ONLY

 REGAL MARINE INDUSTRIES <small>ONTARIO, CANADA</small>		<small>ALL RIGHTS RESERVED</small>	
DRAWING TITLE: 38 GC (SB) Deck Hardware			
DATE:	1/7/2019	REVISION:	-
DRAWN BY:	DMC	APPROVED BY:	-
DRAWING NO.: MSB24A		PAGE NO.: 1 OF 4	

REGAL MARINE INDUSTRIES ASSUMES NO LIABILITY FOR THE USE OF THIS DRAWING IN THE ABSENCE OF THE ORIGINAL DRAWING. THE INFORMATION CONTAINED IN THIS DRAWING IS THE SOLE PROPERTY OF REGAL MARINE INDUSTRIES. PERMISSION TO REPRODUCE THIS DRAWING IS PROHIBITED.

38XO DECK HARDWARE 2

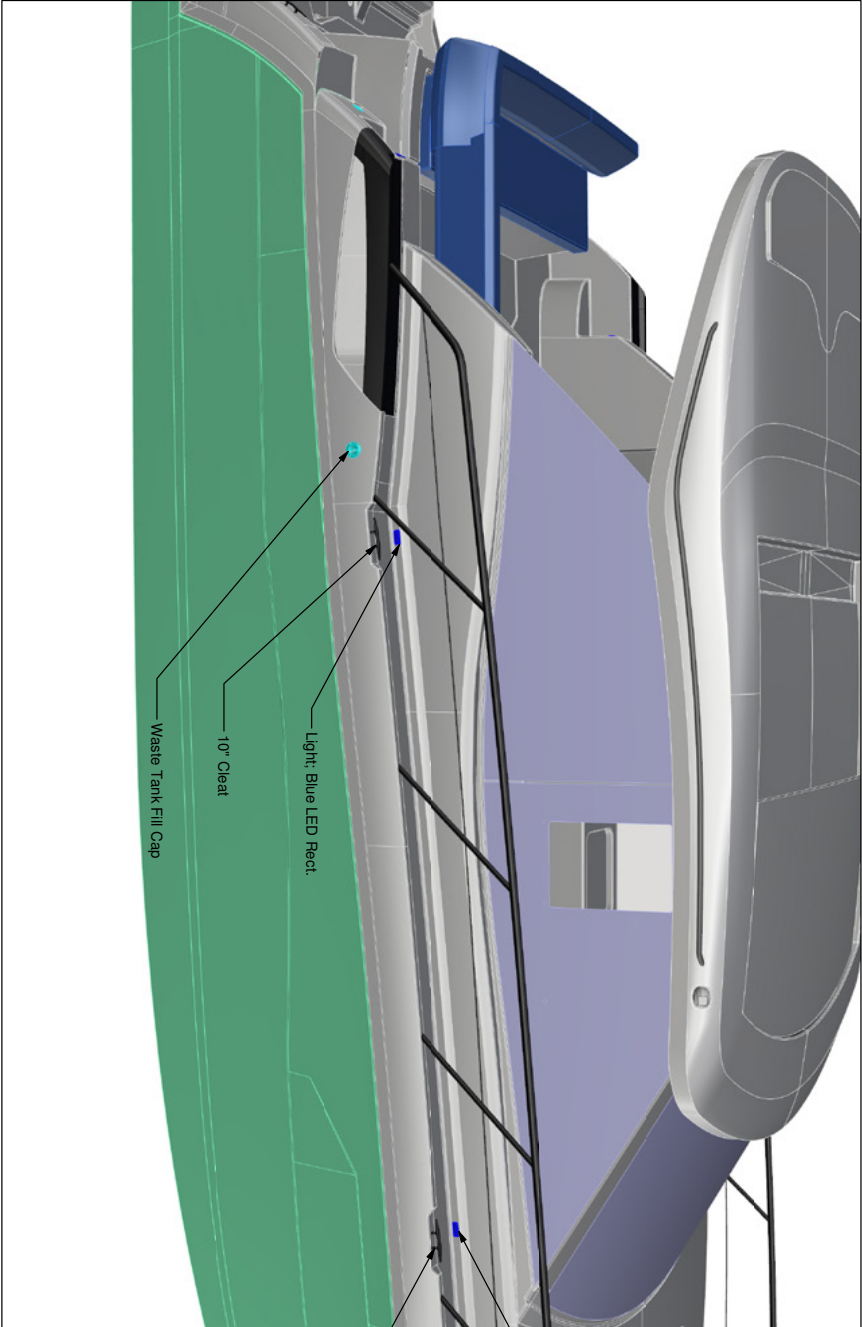

REFERENCE ONLY

REGAL MARINE INDUSTRIES
 1772019
 1/7/2019
 DMC

 REGAL MARINE INDUSTRIES <small>ONTARIO, CANADA</small> <small>TEL: 519-885-4400</small>		<small>ALL RIGHTS RESERVED</small>	
<small>DRAWING TITLE:</small> 38 GC (SB) Deck Hardware	<small>DATE:</small> 1/7/2019	<small>REVISION:</small> -	<small>PAGE:</small> 2 OF 4
<small>DRAWN BY:</small> DMC	<small>APPROVED BY:</small> -	<small>DWG. NO.:</small> MSB24A	

38XO DECK HARDWARE 3

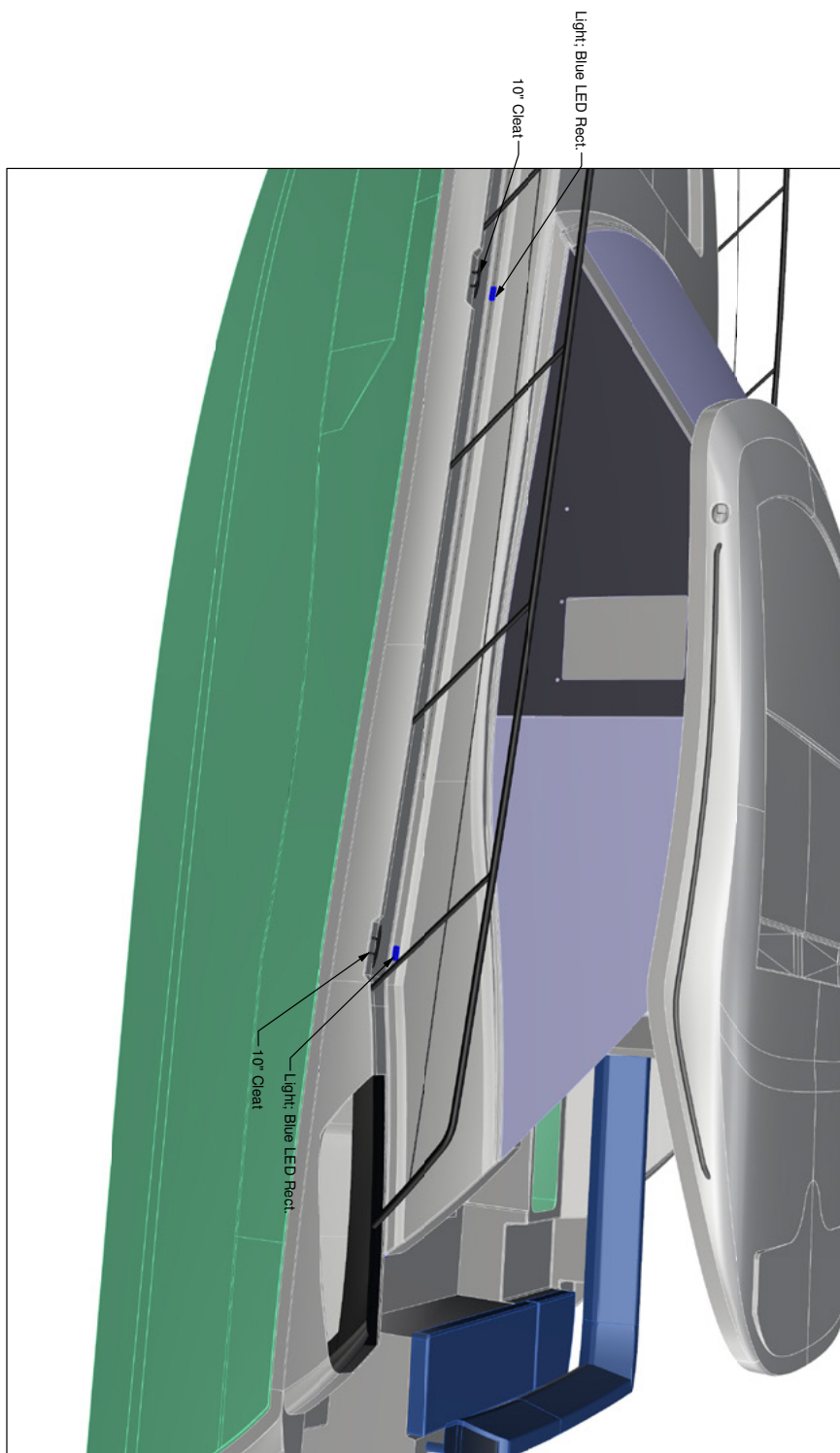

REFERENCE ONLY

REGAL MARINE INDUSTRIES
 38XO DECK HARDWARE
 THE INFORMATION CONTAINED IN THIS DRAWING IS THE SOLE PROPERTY OF REGAL MARINE
 INDUSTRIES. IT IS TO BE USED FOR THE PROJECT AND VESSEL SPECIFICALLY IDENTIFIED.
 PERMISSION OF REGAL MARINE INDUSTRIES IS REQUIRED TO REPRODUCE THIS DRAWING.

 REGAL MARINE INDUSTRIES <small>38XO DECK HARDWARE TEL: 407.261.4400</small>		<small>ALL RIGHTS RESERVED</small>	
DRAWING TITLE: 38 GC (SB) Deck Hardware			
DATE:	1/7/2019	REVISION:	-
DESIGNED BY:	DMC	APPROVED BY:	-
DRAWING NO.:		MSB24A	
PAGE:		3 OF 4	

38XO DECK HARDWARE 4

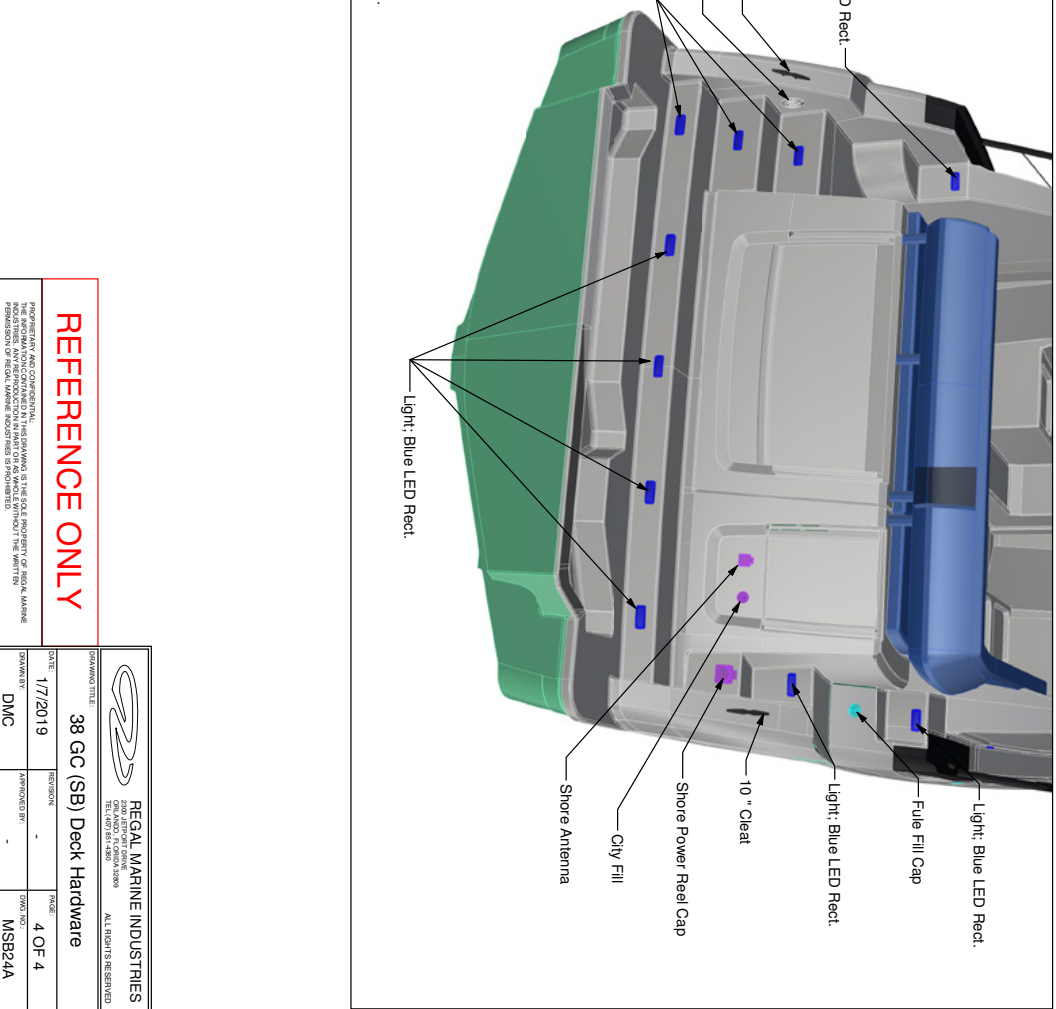
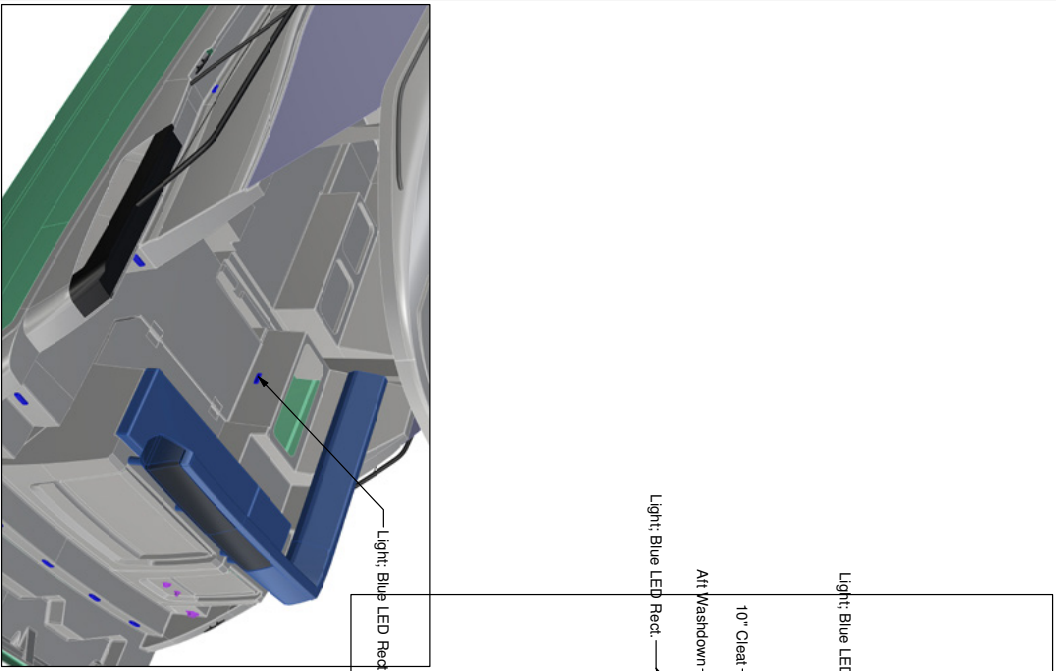

REFERENCE ONLY

REGAL MARINE INDUSTRIES
 1772019
 4 OF 4
 MSB24A

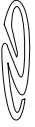
 REGAL MARINE INDUSTRIES <small>1772019 4 OF 4</small>		<small>ALL RIGHTS RESERVED</small>	
<small>DRAWING TITLE:</small> 38 GC (SB) Deck Hardware	<small>DATE:</small> 1/7/2019	<small>REVISION:</small> -	<small>PAGE:</small> 4 OF 4
<small>DRAWN BY:</small> DMC	<small>APPROVED BY:</small> -	<small>DATE:</small> -	<small>MSB24A</small>