



REGAL 38 SAV OWNER'S MANUAL



JUNE 4, 2020 REVISION

Regulatory Notes

FUEL SYSTEMS

Boats manufactured for use in California for model year 2018 and after meet the California EVAP Emissions regulation for spark-ignition marine watercraft. Boats meeting this requirement will have a label affixed near the helm.

WARNING

Operating, servicing and maintaining a recreational marine vessel can expose you to chemicals including engine exhaust, carbon monoxide, phthalates, and lead, which are known to the State of California to cause cancer and birth defects or other reproductive harm. To minimize exposure, avoid breathing exhaust, service your vessel in a well-ventilated area and wear gloves or wash your hands frequently when servicing this vessel. For more information go to: www.P65warnings.ca.gov/marine.

The fuel system in this boat complies with U.S. EPA mandated evaporative emission standards at time of manufacture using certified components. See the label below.

EMISSIONS CONTROL SYSTEM INFORMATION
MEETS U.S. EPA EVAP STANDARDS USING CERTIFIED COMPONENTS AND MEETS 2020 MY CALIFORNIA EVAP EMISSIONS REGULATIONS FOR SPARK-IGNITION MARINE WATERCRAFT
MANUFACTURER: REGAL MARINE INDUSTRIES, INC.
MODEL:
CALIFORNIA EVAP FAMILY: LRMIPVSSL002
EMISSION CONTROL SYSTEM: CM

Note the YYYY MY (model year) along with the California Evap Family first Letter in the Family grouping changes annually in this label.

MANUFACTURER'S WARRANTY

This evaporative emission control system is warranted for two years. If any evaporative emission-related part on your spark-ignition marine watercraft is defective, the part will be repaired by Regal Marine Industries, Inc.

OWNER'S MANUAL RESPONSIBILITIES

- As the spark-ignition marine watercraft owner, you are responsible for the performance of the required maintenance listed in your owner's manual. Regal Marine Industries, Inc. recommends that you retain all receipts covering maintenance on your spark-ignition marine watercraft, but Regal Marine Industries, Inc. cannot deny warranty solely on the lack of receipts.
- As the owner, you should be aware that Regal Marine Industries, Inc. may deny you warranty coverage of your spark-ignition marine watercraft or a part has failed due to abuse, neglect, or improper maintenance or unapproved modifications.
- You are responsible for presenting your spark-ignition marine watercraft to a Regal Marine Industries, Inc. distribution center or a service center as soon as the problem exists. The warranty repairs should be completed in a reasonable amount of time, not to exceed 30 days. If you have any questions regarding your warranty coverage, you should contact Regal Marine Industries, Inc. at 407-851-4360.

Introduction



Boating is becoming more popular each and every year. There are numerous types of recreational vessels on our waterways today involved in an every growing number of activities. Therefore, as a Regal boat owner it is of the highest priority to learn about general boating practices before operating your vessel.

Your Regal dealer will answer many questions and provide valuable “hands on” information during the completion of the new boat delivery process. In addition, your dealer has received special factory training on the product line and his services should be employed to solve any technical problems and periodic maintenance beyond the scope of this manual. Your Regal dealer carries a line of factory approved parts and accessories.

Your Regal dealer can provide information regarding national training organizations such as the U.S. Power Squadron and United States Coast Guard Auxiliary. Along with other organizations and literature, they can help build your “boating savvy” by developing the necessary skills and awareness to be a safe and confident skipper.

Also, your local library can assist in providing recommended boating literature such as Chapman Piloting Seamanship & Boat Handling by Elbert S. Maloney. Also, boating information is available on the internet.

Remember, waterway conditions can change in a heartbeat. Knowing how to react quickly comes from experience and knowledge which can be gained through boating education.

Welcome aboard!

Welcome to Regal

I know I speak for everyone at Regal when I welcome you to the ever-growing family of Regal boat owners. You've chosen a boat that is recognized worldwide for its standard of excellence. Each step in construction has been carefully scrutinized to assure safety, performance, reliability and comfort for both your passengers and yourself.

Your yacht is certified by the National Marine Manufacturers Association. It also complies with the applicable standards set by the United States Coast Guard , American Boat and Yacht Council and the International Marine Certification Institute. Your Regal boat was built with the same attention to detail and quality of construction that we would expect in a craft we would purchase ourselves.

Whether you're a veteran boater or a newcomer, we strongly urge you to read this owner's manual thoroughly. Familiarize yourself with the various components of your vessel, and heed the safety precautions noted herein.

If you have questions that are not covered in this manual, please consult your authorized Regal dealer for assistance, phone the Regal factory at 407-851-4360 or E-mail us at www.regalboats.com.

Thank you, and welcome to the "World of Regal !"

Duane Kuck
President & CEO

Our Mission

With God's Help and a Steadfast Commitment to Integrity,
We will Develop a Team of Exceptional People and Relationships
to Provide Exceptional Customer Satisfaction.

Table Of Contents

2	Notes
3	Introduction
4	Welcome to Regal
6	Chapter 1 - General Vessel Information
18	Chapter 2 - Safety On Board
44	Chapter 3 - Rules Of The Road
54	Chapter 4 - Systems
136	Chapter 5 - Outboard Engines & Controls
162	Chapter 6 - Vessel Operation
177	Chapter 7 - Auxiliary Equipment Operation
216	Chapter 8 - Care & Maintenance
240	Chapter 9 - Troubleshooting
247	Chapter 10 - Storage & Winterization
252	Chapter 11- Glossary & Index
258	Chapter 12 - Technical

Chapter 1

General Vessel Information

Regal Owner's Manual

Your Regal owner's manual has been compiled with information to assist you in operating your craft with safety and pleasure. This manual targets specific details of Regal related systems and components along with their location, operation and maintenance that normally are not found in the vendor information. In addition, supplier related equipment information is located within the owner's information packet.

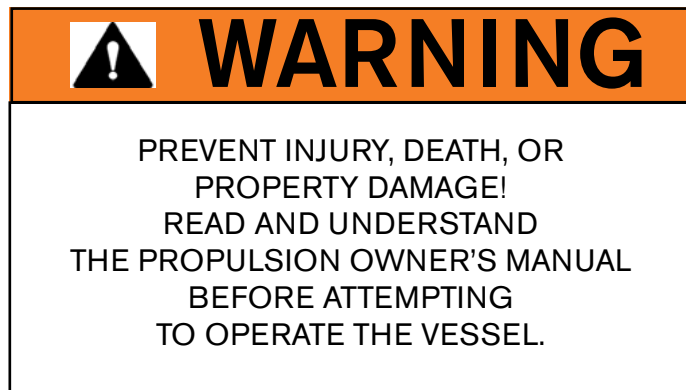

The Regal owner's manual is not to be thought of as a complete shop technical document. Besides the system chapters, there is troubleshooting information devoted to select current standard and optional equipment. In addition, refer to the engine and generator (if installed) operator's manuals. More detailed information may exist in the owner's packet associated with that component.

Remember that your Regal dealer has received special factory training and his services should be employed to solve more technical problems.

Call 407-851-4360 or go to the internet at regalboats.com to find the closest Regal dealership.

In keeping with its commitment to improvement Regal Marine Industries, Inc. is continually upgrading the product line. Regal notes that all dimensions, specifications, models, standard and optional equipment is subject to change without notice at any time.

Regal Owner's Manual QR Label



Currently there is a QR label attached to a visible location such as the helm or cabin. This label when scanned by an I phone will take you via an app to the Regal web-site where you can download

your models owner's manual or for that matter any Regal owner's manual.

With the manual downloaded you can duplicate it into a format you are comfortable using. The QR label is used globally for any type product from the food, home and auto business to boats. It affords much more capacity and is much more customer friendly than the traditional bar code used by manufacturer's on their products. *Other Regal owner's manuals can be found by scanning this QR Code or by going to: regalboats.com/owners*

Owner's Information Packet



An owner's information packet (black satchel) is located on the vessel. Read and become familiar with the materials.

This packet contains valuable information on your propulsion package, standard and optional equipment, systems, care and maintenance along with component warranty. Store the information packet in a clean, dry location on board your vessel.

Vessel Information Sheet

It is recommended that you fill out the information on the following page. It will supply vital statistics on your vessel.

ABYC Yacht Plate



In proximity to the helm on Regal boats over 26' in length is a NMMA (National Marine Manufacturer's

Association) yacht plate. This plate recognizes that your vessel was built to ABYC design compliance standards in effect on the date the certification was verified. The plate also states that your vessel complies with United States Coast Guard safety system standards in effect on the date of certification.

Note: Overloading, improper loading and weight distribution are well documented causes of accidents. Provide for an extra margin of safety in rough sea conditions.

Hull Identification Number

The United States Coast Guard has established a universal system of numerically recognizing vessels by using a hull identification number or "HIN." This number identifies your Regal yachts' model, hull number, month and year of manufacture. The



HIN is normally found on your boat's hull on the starboard side, just below the rub rail on the transom vertical surface. The HIN is stamped on a plate and reinforced with a special adhesive. The HIN consists of 12 alpha or numeric characters.

It is recommended that you locate and write down the HIN for future reference. It can be especially useful when ordering parts from your Regal dealer. A second HIN number is found in a hidden location. This second HIN is useful to authorities if the vessel is stolen and/or the original transom HIN is modified or eliminated.

Formulate the float plan on the following page before departing. Leave it with a responsible person who will notify the United States Coast Guard or local law enforcement authorities if you do not return as planned. If you change your plans be sure to notify this person. Make copies of the float plan and use one each time you go boating. This will help people know where to find you should you not return on schedule. Do not file the float plan with the United States Coast Guard.

Vessel Float Plan

Do not file the float plan with the United States Coast Guard.

Vessel Information Sheet

Owner: _____

Address: _____

City & State: _____

Home Phone: _____ Business Phone: _____

In Case Of Emergency Notify: _____

Address _____

City & State _____

Phone _____

Insurance Agent's Name: _____

Policy#: _____

USCG Phone: _____ Local Police: _____

Marina Phone: _____ Slip (Dock#): _____

Hull Serial #: RGM _____

Key #: _____ Engine: _____

Selling Dealer: _____

Address: _____

City & State: _____

Phone: _____ Fax: _____

Servicing Dealer: _____

Address: _____

City & State: _____

Phone: _____ Fax: _____

Vessel Float Plan

Fill out this form before departure. Leave it with a responsible person who will notify the Coast Guard or police if you don't return as planned. If you change your plans be sure to notify this person. Make copies of the float plan and use one each time you go on a trip. This will help people know where to find you should you not return on schedule. Do not file this plan with the Coast Guard.

Owner: _____
Address: _____
City & State: _____
Telephone#: _____

Person Filing Report: _____
Name _____
Telephone _____

Make Of Craft: _____
Length _____ Boat Name _____
Color _____ Trim _____ Hp _____
Inboard _____ Stern Drive _____
Hull I.D.# _____
Documented Vessel # _____

Other Information _____

Safety Equipment Aboard: _____
Life Jackets _____
First Aid Kit _____
Flares _____
Flash Light _____
VHF Radio _____
Cell Phone __# _____
Computer __Desk Top ____Lap Top____
E-mail address _____
Food _____Water _____

State Registration# _____
Destination: _____
Leave From _____
Time Left _____
Going To _____
Fuel Capacity _____
Est. Day Of Arrival _____

Est. Time Of Arrival _____
If Not Back By _____ o'clock Call Authorities

Persons Aboard:

Name	Age	Address	Phone
_____	_____	_____	_____
_____	_____	_____	_____
_____	_____	_____	_____
_____	_____	_____	_____
_____	_____	_____	_____

____ See Other Side For Additional Persons

Vessel Cruise Checklist

- Obtain a current weather update.
- Hoist the boat & periodically inspect the hull bottom and propellers for damage. Marine growth such as barnacles will affect performance and fuel efficiency. Check sacrificial anodes located on the propulsion unit, transom and engine. Replace anode if less than 2/3 remaining.
- Check the electrical system and all safety related equipment. Carry extra fuses. Ensure they are of the proper capacity and type.
- If your boat has been in the water, run the bilge pump until the flow of water stops.
- Check to see that all bilge water has drained and the drain plug is installed before launching. If your boat has been out of the water.
- Check that all required safety equipment is on board and in good working condition. Examples include personal flotation devices (PFD's), horn, bell, hand held fire extinguishers, and visual distress signals.
- Check fuel level. Fuel tanks should be filled to slightly less than capacity. Allow for fuel expansion. Remember the "one third rule".
- Open engine compartment. Inspect for fuel odors and visible leaks in the fuel, oil, coolant, exhaust and power steering systems.
- Check all fuel filters for the presence of water.
- Check fluid levels of engines, drives and generator (if applicable).
- Inspect engine for cracked hoses, worn or loose belts, and loose hardware.

Recommended On Board Equipment

Tools:

Allen Wrenches
Jack Knife
Phillips Screwdriver
Regular & Needle Nose Pliers
Combination Box & End Wrench Set
Screwdriver Set (One With Various Tips)
Side Cutters
Ratchet & Socket Set
Electrical Crimper,Cutter,Stripper Combo
Hammer
VOA Electrical Tester
Water Pump Pliers
Vise Grip Pliers
Floating Flashlight/Lantern
Oil/Fuel Filter Wrench
Tape Rule

Basic Gear & Supplies:

Tow Line
Lubricating Oil, Liquid Wrench
Mooring Lines
Duct & Electricians Tape
Dock Fenders
Coolant (Engine Freshwater Side)
Distress Signals
Engine, Drive, Power Steering Oil
First Aid Kit
Boat Soap (Not Dish Soap)
Boat Hook
Woody Wax
Charts & Plotting Instruments
Vinyl Cleaner
Emergency Food & Water
Hydrogen Peroxide (AC Pans)
EPIRB

Spare Parts:

Fuel Filters-Engines & Generator
Poly V- Belt (See Engine Manual)
Coolant For Engine Freshwater System
Extra Light Bulbs
Seawater Filter
Fuses
Propeller Set (See Dealer)
Propeller Hardware
Flashlight Batteries
Engine Spare Parts
Generator Spare Parts
Air Filters-Engine & Generator
Oil Filters-Engine, Generator
Drive Oil Filters

Life Raft
Bailer or Hand Pump
Rust Stain Remover (Star Brite)
Extra Hand Held Fire Extinguishers
Corrosion Block
Personal Floatation Devices
Bilge Cleaner
Clean Rags, Diapers- For Oil Leaks
Nylon Windbreaker Suit
Sunscreen (SPF 30+)
Shop Vacuum (1 Gal. Cap. Wet-Dry)
Bucket/Pans w/Lids-Draining/Storing
Used Fluids
Squeegee
Mirror (For Inspection & Emergency Signaling)
Binoculars

Owner's Registration & Systems

Please note that your boat requires the proper registration by your authorized Regal dealer. To initiate the vessel warranty your dealer must complete the owner's registration form and systems checklist at the time of delivery. The owner must sign the paperwork to acknowledge that the dealer has reviewed the boat systems and warranty provisions with the owner. The owner should keep the original paperwork that features a temporary warranty registration. A warranty certificate will be sent several weeks after receipt of the paperwork at Regal World Headquarters.

Dealer's Responsibility

Your vessel has undergone rigid quality assurance inspections before leaving the factory. In addition, your dealer has been trained to perform final pre-delivery checks and to service your Regal boat.

Your dealer's responsibilities include:

1. An orientation in the operation of your Regal boat including matters relating to the safe operation of the vessel.
2. Completion and mailing of your boat registration warranty form to Regal.
3. Location of vendor warranties, registration materials, owner's manual, operation, installation and maintenance instructions for auxiliary equipment supplied with or installed on your Regal boat.

Owner's Responsibility

You are entitled to all the benefits and services outlined in your Regal warranty. However, you have certain responsibilities to ensure warranty satisfaction. These are:

To read the warranty materials and understand them fully.

To examine the vessel in detail at the time of delivery.

To apply the following: boating rules and regulations, safety equipment, environmental regulations, accident reports and warranty regulations terms and conditions.

To read thoroughly all literature supplied with your boat including this owner's manual and to follow the recommendations in the literature.

To provide proper maintenance and periodic servicing of your boat and equipment as set forth in the various manuals supplied.

Customer Service

Take the time to write down your Regal dealer's phone number and E-mail address for future reference. Along with your Regal dealer information is a listing below of other phone numbers and web addresses which may prove useful.

Regal Dealer:

Phone: _____

E-mail: _____

Regal Marine Customer Service:

1-800-US REGAL (1-800-877-3425)

regal@regalboats.com

customer.service@regalboats.com

REGAL MARINE INDUSTRIES, INC. LIMITED WARRANTY

Welcome to the Worldwide Family of Regal Owners! We are very pleased that you have chosen a Regal Powerboat!

This document is your Limited Warranty Registration Certificate and Statement of Limited Warranty. Please check the registration information section for accuracy. If this information is not correct or if you change your address at some future date, please notify us at the following address: Regal Marine Industries, Inc. Attention: Warranty Registrations, 2300 Jetport Drive, Orlando, Florida 32809; or e-mail customerservice@regalboats.com.

Please read the warranty carefully. It contains important information on Regal's claims procedures and your rights and obligations under this warranty.

WHAT IS COVERED: This Limited Warranty applies only to Regal boats beginning with model year 2017.

LIFETIME LIMITED STRUCTURAL DECK & HULL WARRANTY: Regal Marine Industries, Inc. warrants to the original retail purchaser of this boat if purchased from an authorized Regal dealer that the selling dealer or Regal will repair or replace the factory installed fiberglass if it is found to be structurally defective in material or workmanship for as long as the original retail purchaser owns the boat. For purposes of this Limited Warranty, the hull is defined as the single fiberglass casting which rests on the water. This Limited Warranty is subject to all limitations and conditions explained below.

FIVE-YEAR TRANSFERABLE LIMITED STRUCTURAL HULL WARRANTY: In addition to the Lifetime Limited Structural Hull Warranty, Regal offers a Transferable Five-Year Limited Structural Hull Warranty. Under the Five-Year Transferable Limited Structural Hull Warranty, Regal will repair or replace the fiberglass hull or deck if it is found to be structurally defective in material or workmanship within the first (5) years after the date of delivery to the original retail purchaser. Any remaining term of this Five-Year Limited Hull Warranty may be transferred to a second owner if within 60 days of purchase, the new owner registers the transfer with Regal and pays the established Limited Warranty transfer fee. Contact Regal Customer Service at the above address for details.

FIVE-YEAR LIMITED HULL BLISTER WARRANTY: Regal warrants that the Regal selling dealer or Regal will repair any underwater gelcoated surfaces of the hull against laminate blisters which occur as a result of defects in material or workmanship within (5) years of the date of delivery, provided that the original factory gelcoat surface has not been altered. Alternation would include but is not limited to damage repair; excessive sanding, scraping, sandblasting; or from improper surface preparation for application of a marine barrier coating or bottom paint, any of which shall void this Five-Year Limited Hull Blister Warranty. Proper preparation must be applied to the hull bottom if the boat is to be moored for periods in excess of (60) days. Regal Marine shall repair or cause to be repaired any covered laminate blisters based on the following prorated schedule. Less than three (3) years from delivery date - 100%, Three (3) to (4) years from delivery date - 50%, Four (4) to (5) years from delivery date - 25%.

Reimbursement shall be limited to one repair, not to exceed (\$100.00) dollars per foot of boat length prior to prorating. Regal's prior authorization for the method and cost of repair, must be obtained before repairs are commenced. All costs to transport the boat for repairs are the responsibility of the owner.

LIMITED GENERAL WARRANTY: In addition to above hull warranties, Regal warrants to the original purchaser of this boat if purchased from an authorized Regal dealer, that the authorized Regal dealer or Regal will repair or replace any parts found to be defective in materials or workmanship for a period of one (1) year from the date of delivery, subject to all exceptions, limitations and conditions contained herein.

LIMITED EXTERIOR FINISH WARRANTY: Regal warrants that the authorized Regal selling dealer or Regal will repair cosmetic defects in the exterior gelcoated finish including cracks, air voids or crazing for one year from the date of delivery, subject to all limitations and conditions contained herein. All warranty work is to be performed at a Regal dealership or other location authorized by a Regal Customer Service Manager after it is established to Regal's satisfaction that there is a defect in material or workmanship.

CUSTOMER OBLIGATIONS: The following are conditions precedent to the availability of any benefits under these limited warranties:

(a) The purchaser, who is not Regal's sales agent and is otherwise not in any general or sales agency relationship with Regal, must sign and the authorized Regal selling dealer, must submit to Regal the "NEW BOAT DELIVERY and ACCEPTANCE CHECKLIST" within fifteen (15) days of the date of delivery and such information must be on file at Regal.

(b) The purchaser must first notify the authorized Regal selling dealer from whom the boat was purchased of any claim under this Limited Warranty within the applicable Limited Warranty period and within a reasonable period of time (not to exceed thirty (30) days) after the defect is or should have been discovered.

(c) Regal will not be responsible to repair any condition or replace any part, (1) if the use of the boat is continued after the defect is or should have been discovered; and (2) if such continued use causes other or additional damage to the boat or component parts of the boat.

(d) Based on the authorized Regal selling dealer's knowledge of Regal's Limited Warranty policy and/or consultations with Regal, the dealer will accept the claim and arrange for appropriate repairs to be performed, or deny the claim if it is not within the Limited Warranty policy.

(e) The authorized Regal selling dealer will contact the Regal boat owner regarding instructions for delivery of boat or part for covered warranty repair if it is covered by the Limited Warranty.

ALL COSTS TO OR FROM THE BOAT AND/OR TRANSPORT OF THE BOAT FOR REPAIRS ARE THE RESPONSIBILITY OF THE OWNER.

(f) If the Regal boat owner believes a claim has been denied in error or the authorized Regal selling dealer has performed the warranty work in an unsatisfactory manner, the owner must notify Regal's Customer Service Department in writing at the address listed for further consideration. Regal will then review the claim and take appropriate follow-up action.

(g) Before bringing any action, claim, lawsuit, or otherwise seeking relief against Regal based on any alleged breach of any of the Limited Warranties, terms or conditions herein, the Regal Boat owner must contact Regal's Customer Service Department Directly allow Regal, beyond those efforts made by its authorized Regal dealer, notice an opportunity to cure any alleged breach of any of the terms of any of the Limited Warranties.

WARRANTY EXCEPTIONS: THIS LIMITED WARRANTY does not cover, the following are not warranted are excluded from the terms of the Regal Limited Warranty and the following terms apply to any Regal Limited Warranty.

- (a) Engines, drives, controls, propellers, batteries, metal plating or finishes, windshield breakage, leakage, fading and deterioration of paints, canvas, vinyl, upholstery and fabrics;
- (b) Gelcoat surfaces including, but not limited to discoloration or blistering except as noted above;
- (c) Accessories and items which were not part of the boat when shipped from the Regal factory, or which carry their own individual warranty and/or any damage caused by such accessories or items;
- (d) Damage caused by one or more of the following: misuse, accident, corrosion, galvanic corrosion, negligence, lack of proper maintenance, or improper trailering;
- (e) Any boat used for racing, or used for rental or commercial purposes;
- (f) Any boat operated contrary to any instructions furnished by Regal, including instructions and guidance provided in the Regal Owner's Manual, or operated in violation of any federal, state, Coast Guard or other governmental agency laws, rules, or regulations;
- (g) The limited warranty is void if alterations have been made to the boat;
- (h) Transportation of boat or parts to and/or from the REGAL factory or service location;
- (i) Travel time or haul outs, loss of time or inconvenience;
- (j) Any published or announced catalog performance characteristics of speed, fuel and oil consumption, and static or dynamic transportation in the water;
- (k) Any boat that has been re-powered beyond Regal's power recommendations;
- (l) Boats damaged by accident and boats damaged while being loaded onto, transported upon or unloaded from trailers, cradles, or other devices used to place boats in water, remove boats from water or store or transport boats on or over land;
- (m) Any item repaired, replaced or modified under the terms of this warranty does not in any way prolong, extend or change any terms set forth in this limited warranty;
- (n) Water damage to, dry rot to, condensation to, or absorption by interior surfaces, wood structures or polyurethane foam; interior wood including, but not limited to mold, bleeding and/or discoloration as a result of condensation or moisture or water continually contacting the plywood causing staining to upholstery, carpet or other interior surfaces;
- (o) Costs or charges derived from inconvenience or loss of use, commercial or monetary loss due to time loss, and any other special, incidental or consequential damage of any kind or nature whatsoever;
- (p) Regal reserves the right to improve the design or manufacture process of Regal boats without obligation to modify previously produced product;

NO WAIVER OF THESE TERMS: The terms, conditions, limitations and disclaimers contained herein cannot be waived except by the Customer Service Manager of Regal. Any such waiver must be in writing. Neither the dealer, nor the customer, nor any service, sales and/or warranty representative of Regal is authorized to waive and/or modify these conditions, limitations and/or disclaimers.

EXCEPT AS SET FORTH HEREIN OR ON ANY OTHER WRITTEN EXPRESS LIMITED WARRANTIES BY REGAL, THERE ARE NO OTHER WARRANTIES EITHER EXPRESSED OR IMPLIED PROVIDED BY REGAL ON THIS BOAT. ALL OTHER WARRANTIES, EXPRESS OR IMPLIED, INCLUDING IMPLIED WARRANTIES OF FITNESS AND MERCHANTABILITY, ARE EXPRESSLY EXCLUDED. REGAL FURTHER DISCLAIMS ANY LIABILITY FOR ECONOMIC LOSS ARISING FROM CLAIMS OF PRODUCT FAILURE, NEGLIGENCE, DEFECTIVE DESIGN, MANUFACTURING DEFECT, FAILURE TO WARN AND/OR INSTRUCT, LACK OF SEAWORTHINESS, AND ANY OTHER THEORY OF LIABILITY NOT EXPRESSLY COVERED UNDER THE TERMS OF THIS LIMITED WARRANTY.

AS SET FORTH ABOVE, REGAL MAKES NO IMPLIED WARRANTY OF MERCHANTABILITY AND EXPRESSLY EXCLUDES ANY SUCH WARRANTY. TO THE EXTENT SUCH EXCLUSION IS NOT ALLOWED BY LAW OR AN IMPLIED WARRANTY OF MERCHANTABILITY IS ALLOWED BY LAW: (1) ANY IMPLIED WARRANTY OF MERCHANTABILITY THAT IS, AS A MATTER OF LAW, NOT PERMITTED TO BE EXCLUDED AS SET FORTH ABOVE, IS LIMITED TO ONE

YEAR FROM THE DATE OF DELIVERY TO THE FIRST RETAIL OWNER; (2) NEITHER REGAL NOR ANY SELLING DEALER SHALL HAVE ANY RESPONSIBILITY FOR LOSS OR USE OF THE BOAT, LOSS OF TIME, INCONVENIENCE, COMMERCIAL LOSS, INCIDENTAL OR CONSEQUENTIAL DAMAGES. SOME STATES MAY NOT ALLOW EXCLUSIONS OF IMPLIED WARRANTIES OR LIMITATIONS ON HOW LONG ANY IMPLIED WARRANTY LASTS, SO THE ABOVE LIMITATION MAY NOT BE APPLICABLE. SOME STATES MAY NOT ALLOW THE EXCLUSION OR LIMITATION OF INCIDENTAL OR CONSEQUENTIAL DAMAGES, SO THE ABOVE LIMITATIONS OR EXCLUSIONS MAY NOT BE APPLICABLE IN THOSE STATES. THIS WARRANTY GIVES THE OWNER SPECIFIC LEGAL RIGHTS, AND THE OWNER MAY ALSO HAVE OTHER RIGHTS WHICH VARY FROM STATE TO STATE.

THE TERMS AND CONDITIONS CONTAINED HEREIN, AS WELL AS THOSE OF ANY DOCUMENTS PREPARED IN CONJUNCTION WITH THE SALE OF THIS VESSEL MAY NOT BE MODIFIED, ALTERED OR WAIVED BY ANY ACTION, INACTION OR REPRESENTATIONS, WHETHER ORAL OR IN WRITING, EXCEPT UPON THE EXPRESSED, WRITTEN AUTHORITY OF A MANAGEMENT LEVEL EMPLOYEE OF REGAL. Some states do not allow limitations on how long an implied warranty lasts, so the above limitation may not apply to you. Regal's obligation with respect to this warranty is limited to making repairs to or replacing the defective parts and no claim for breach of warranty shall be cause for cancellation or rescission of the contract or sale for any boat manufacturer by REGAL MARINE INDUSTRIES, INC.

Regal will discharge its obligations under this warranty as rapidly as possible, but cannot guarantee any specific completion date due to the different nature of claims which may be made and services which may be required. Regal reserves the right to change or improve the design of its boats without obligation to modify any boat previously manufactured. This limited warranty gives you specific legal rights, and you may also have other rights which may vary from state to state. Regal shall in no way be responsible for any repairs not PRE-AUTHORIZED by a Regal Customer Service Manager or repairs performed by a repair shop not PRE-AUTHORIZED by a Regal Customer Service Manager.

ARBITRATION OF DISPUTES AND WAIVER OF JURY TRIAL

EXCEPT AS SPECIFICALLY EXCLUDED IN THIS LIMITED WARRANTY, PURCHASER, REGAL AND AUTHORIZED REGAL DEALER AGREE TO SUBMIT ANY AND ALL CONTROVERSIES, CLAIMS OR DISPUTES ARISING OUT OF OR RELATING TO THE BOAT AND THIS LIMITED WARRANTY AND ALL OTHER AGREEMENTS EXECUTED BY PURCHASER RELATED TO THE BOAT TO BINDING ARBITRATION. IT IS THE EXPRESS INTENT OF PURCHASER, REGAL AND DEALER THAT THIS ARBITRATION PROVISION APPLIES TO ALL DISPUTES, INCLUDING CONTRACT DISPUTES, TORT CLAIMS, FRAUD CLAIMS AND FRAUD-IN-THE INDUCEMENT CLAIMS, STATUTORY CLAIMS AND REGULATORY CLAIMS RELATING IN ANY MANNER TO THE BOAT AND THIS LIMITED WARRANTY.

IF ANY CONTROVERSY OR CLAIM DESCRIBED IN THIS ARBITRATION PROVISION IS DETERMINED FOR ANY REASON TO BE INELIGIBLE FOR ARBITRATION, AND FOR ANY CONTROVERSIES, CLAIMS, OR DISPUTES SPECIFICALLY EXEMPTED FROM ARBITRATION, THEN THOSE CONTROVERSIES, CLAIMS, OR DISPUTES SHALL INSTEAD BE DECIDED BY A JUDGE OF A COURT OF COMPETENT JURISDICTION, IN ORANGE COUNTY, FLORIDA, WITHOUT A JURY. PURCHASER, REGAL AND DEALER KNOWINGLY AND VOLUNTARILY WAIVE THE RIGHT TO A TRIAL BY JURY FOR ALL SUCH CONTROVERSIES, CLAIMS AND DISPUTES. PURCHASER, REGAL, AND DEALER UNDERSTAND THAT THERE SHALL BE NO JURY TRIAL, WHETHER THE CONTROVERSY OR CLAIM IS DECIDED BY ARBITRATION OR BY TRIAL BEFORE A JUDGE. NOTWITHSTANDING THE PROVISIONS OF THIS ARBITRATION AGREEMENT, WITH REGARD TO CONTROVERSIES AND/OR ENTITLEMENT TO POSSESSION OF EITHER THE BOAT OR ANY TRADE-IN, ANY PARTY HERETO MAY RESORT TO A JUDICIAL DETERMINATION (BY A JUDGE AND NOT A JURY). OF SUCH CONTROVERSIES, DISPUTES OR CLAIMS WITHOUT WAIVING ANY RIGHT TO DEMAND ARBITRATION WITH RESPECT TO ALL OTHER CONTROVERSIES, DISPUTES OR CLAIMS BETWEEN THE PARTIES A MORE SPECIFICALLY SET FORTH IN THIS ARBITRATION PROVISION.

ALL ARBITRATIONS SHALL PROCEED THROUGH THE AMERICAN ARBITRATION ASSOCIATION AND BE SUBJECT TO ITS COMMERCIAL ARBITRATION RULES, EXCEPT AS SET FORTH HEREIN. THE ARBITRATORS SHALL HAVE THE AUTHORITY TO AWARD ANY FORM OF RELIEF THAT COULD BE PROPERLY AWARDED IN A CIVIL ACTION IN THE STATE OF FLORIDA FOR THE TYPE OF CLAIMS PRESENTED, SUBJECT HOWEVER, TO ALL LIMITATIONS, PREDICATES, AND CONDITIONS COVERING SUCH REMEDIES OR RELIEF UNDER FLORIDA LAW.

THE PURCHASER, REGAL OR DEALER MAY DEMAND ARBITRATION OF A CLAIM BY FILING A WRITTEN DEMAND FOR ARBITRATION, ALONG WITH A STATEMENT OF THE MATTER IN CONTROVERSY WITH THE AMERICAN ARBITRATION ASSOCIATION, AND SIMULTANEOUSLY SERVING A COPY UPON THE OTHER PARTY. PURCHASER, REGAL AND DEALER AGREE THAT THE ARBITRATION PROCEEDING SHALL BE CONDUCTED IN ORANGE COUNTY, FLORIDA UNLESS OTHERWISE AGREED BY THE PARTIES. EACH PARTY AGREES TO BEAR THEIR OWN ATTORNEY FEES AND COSTS. THE FILING FEES AND ALL OTHER THIRD-PARTY COSTS FOR THE ARBITRATION, INCLUDING THE ARBITRATOR'S FEE SHALL BE PAID BY THE FILING PARTY INITIATING THE ARBITRATION. THE PREVAILING PARTY SHALL BE ENTITLED TO REIMBURSEMENT OF THEIR REASONABLE ATTORNEY FEES AND REASONABLE EXPENSES FROM THE NON-PREVAILING PARTY.

REGISTRATION INFORMATION:

Chapter 2

Safety On Board



S a f e t y awareness can not be over emphasized. Safety on board needs to be

the skippers number one priority. In this manual you will find many safety precautions and symbols to identify safety related items. Heed all safety precaution information. Remember, the skipper is responsible for the safety of his passengers.

Safety Labels

Safety Precaution Definition:

Safety precautions are stated as caution, warning and danger signal words. They are highlighted in this manual by font design and symbol usage. Also, a notice heading is included which provides operation and maintenance information but is not hazard-related. An information label provides tips on a variety of topics.

Read and understand all safety labels affixed to your Regal boat or found in this manual and the vendor literature. Many of the safety labels are posted close to the helm, aft cockpit, cabin and swim platform. The location of the labels may vary. Review the helm safety labels with passengers before disembarking. Use common sense to analyze the result of an action on board your vessel. Always think safety first!

NOTICE

General or specific information which is important to correct operation or maintenance, but is not hazard related.



CAUTION

Indicates a potentially hazardous situation or unsafe practice that, if not avoided, may result in injury, property or product damage.



WARNING

Potentially hazardous situation that, if not avoided, could result in death or serious injury.



DANGER

Immediate hazardous situation that if not avoided, will result in death or serious injury.

NOTICE

DO NOT REMOVE OR COVER ANY PRECAUTIONARY LABELS. KEEP HARSH CHEMICALS AWAY FROM LABELS. IF A LABEL BECOMES ILLEGIBLE, CONTACT YOUR REGAL DEALER FOR ORDERING REPLACEMENTS.

General Boating Safety

We understand that you are eager to go boating. However, we strongly suggest that you thoroughly familiarize yourself and friends or members of your family with safe boating practices before setting out. Remember, that along with the freedom and exhilaration of boating comes the responsibility that you have for the safety of your passengers and other boaters who share the water with you.

Boating regulations vary from state to state. Check with your local and state authorities for the regulations pertaining to your area.

Check with local FM weather stations, U. S. Coast Guard, or on-line for the latest weather conditions.

Remember getting caught in severe weather is hazardous. Check weather conditions periodically while you are boating. If you are forced to operate your boat in a storm condition, take common sense precautions; wear PFD's, store gear, reduce speed and if possible head for safe refuge.

It is best to avoid operating your boat in foggy weather. When fog sets in, take bearings, log courses and speeds. You are required to emit a five second blast from your horn or whistle once every minute. Also, have your passengers wear PFD's and observe for oncoming vessels.

Operation in shallow water presents a number of hazards including sand bars and water levels influenced by tides. If the vessel strikes an underwater hazard, check for boat and engine damage. If the engine vibrates excessively after striking an underwater obstruction, it may indicate a damaged propeller. If you run aground, seek help by radio or flares.

Make sure your boat and equipment are in top condition. Do this by frequently inspecting the hull, engine and propulsion components.

You must provide a Coast Guard approved personal flotation device (PFD) for every person on board. These PFD's should be in good condition and easily accessible.

Insist that non-swimmers and children on board wear a PFD at all times. If you encounter rough weather conditions, make sure everyone on board is wearing a PFD, including yourself. Instruct your passengers in how to put on their PFDs and be sure they know their storage location on the boat. Remember, in an emergency, a PFD that cannot be quickly located and worn is useless.

Never allow anyone to sit anywhere on the boat not specifically designed as seating. **While underway, ALWAYS insist passengers occupy a recognized seat as shown on page 215 of this manual.**

Never drink and drive! As captain, you are responsible for the safety of your passengers. Alcohol and boating can be a dangerous combination. **DO NOT**



mix them. Alcohol impairs the boat operators ability to make conscious decisions and react to emergency situations quickly.

Never overload your boat! An overloaded boat, or one with uneven weight distribution can be difficult to steer. **Never let people stand in bow area while underway as vision will be obstructed!!!**

Insist that passengers wear life jackets and sit in the designated seats per the seating arrangement plan in the technical section of this manual while the vessel is underway!

 **CAUTION**

READ AND UNDERSTAND THE SEATING ARRANGEMENT DRAWING IN THE TECHNICAL CHAPTER. THIS DRAWING DISPLAYS THE DESIGNATED SEATING ARRANGEMENT FOR A BALANCED LOAD AND VESSEL MAXIMUM PERSONS CAPACITY.

Use maximum caution when fueling. Never allow any smoke or flame nearby while you are fueling. Be certain there is enough fuel aboard for your cruising needs especially if your cruise distance expands.

Practice the “one-third rule: Use one-third of your fuel going out, one-third to return and retain one-third as a reserve.

Always check the weather before departure. Be particularly cautious of forecasted electrical storms and high winds.

Always have up-to-date charts aboard as a back-up to your plotter and auto pilot option. Charts can be obtained at your closet marina, on-line store or by contacting one of three federal government agencies.

Always file a float plan. Leave details of your trip with someone responsible who will be remaining on shore. Include expected return, plus name and phone number of a contact person in case of emergency.

Use care, courtesy and common sense when launching, docking or operating your boat.

Learn and obey the “Rules of the Road”. A weather resistant placard copy of the “Rules of the Road” is included in the on board Regal information packet. Additional information can be obtained from the U.S. Coast Guard Auxiliary or your local Power Squadron organization.

In case of emergency know the international distress signals for your VHF radio. The spoken word “MAYDAY” is the international signal of distress and is for emergency use only. Under no circumstances should this word be used, unless there is danger at hand.

Operation in shallow water presents a number of hazards including sand bars and water levels influenced by tides. If the vessel strikes an underwater hazard, check for boat and engine damage. If the engine vibrates excessively after striking an underwater obstruction, it may indicate a damaged propeller. If you run aground, seek help by radio or flares.

Make sure your boat and equipment are in top condition. Do this by frequently inspecting the hull, engine and propulsion components.

You must provide a Coast Guard approved personal flotation device (PFD) for every person on board. These PFD's should be in good condition and easily accessible.

Again, insist that non-swimmers and children on board wear a PFD at all times. If you encounter rough weather conditions, make sure everyone on board is wearing a PFD, including yourself. Instruct your passengers in how to put on their PFDs and be sure they know their storage location on the boat. Remember, in an emergency, a PFD that cannot be quickly located and worn is useless.

Never allow anyone to sit anywhere on the boat not specifically designed as seating. While underway, ALWAYS insist passengers sit in a seat and set an example by doing this yourself.

Never drink and drive! As captain, you are responsible for the safety of your passengers. Alcohol and boating can be a dangerous combination. DO NOT mix them. Alcohol impairs the boat operators ability to make conscious decisions and react to emergency situations quickly.

Never overload your boat! An overloaded boat, or one with uneven weight distribution can be difficult to steer.

Insist that passengers sit in seats while the vessel is making headway!! See technical chapter for seating positions while underway. No one to be standing in the bow area while underway as visibility will be obstructed!!!

Posted speed limits, swimming areas, "no wake" zones and other restrictions should be red-flagged. They are so noted for a reason. Sensible boat use, plus courtesy, equals enjoyable and safe boating.

It is your responsibility to stay abreast of all federal, state and local rules, as some laws or regulations may change or be different from state to state. Contact your local boating agencies for updated information.

We can not stress safety enough! Remember, there are no brakes on your boat, and the water current and wind velocity both affect your ability to respond.

Safety on board deck is a must do item for the boat operator. Always use common sense when boarding and exiting, making headway and anchoring in open waters.

Following are recommendations when using components such as the boarding platform and ladder, foredeck and hand holds.

Aft Platform

On all types of aft platforms you should make periodic inspections of the hardware that support the platform to ensure that all connections and fittings are tight and in good condition.

Use caution when operating the boat in reverse to insure that water does not accumulate excessively on the platform or transom, especially in rough seas or strong currents. If installed, do not exceed the recommended maximum capacity label!

Typical label shown (vary by platform type/model).



Read and understand the warning label above regarding "teak surfing."



TYPICAL OUTBOARD AFT PLATFORM

Boarding Ladder

When exiting using the ladder ensure it is fully extended and your feet are firmly planted on each rung. When entering the vessel using the ladder make sure the ladder is fully extended and the ladder cover is latched to safely use the hand hold integrated into the cover.

Note to never use any segment of the outboard motor to assist in boarding! Body parts could be injured by the propeller blades. Always ensure the boarding ladder is fully folded and the cover latched before making headway!



TYPICAL BOARDING LADDER

Boarding Steps-Starboard Foredeck

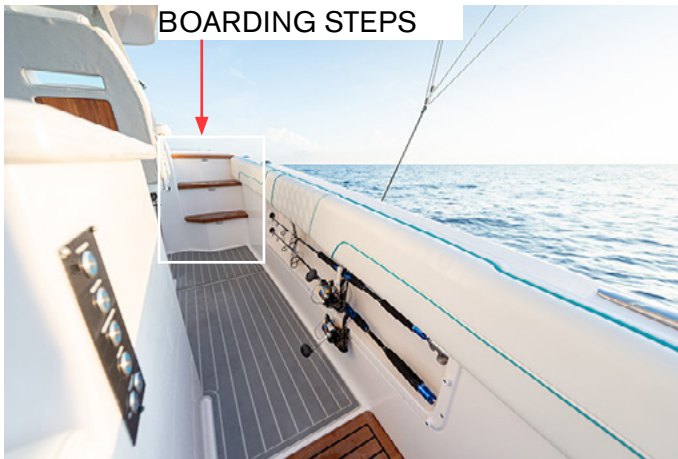

The vessel features a starboard set of boarding steps used for embarking when mooring. When entering or exiting the vessel utilize the hard top hand holds.

Make sure the vessel is moored securely before embarking.

Read and understand the following label installed on the step riser. As the vessel operator inform passengers not to use the boarding steps when the boat is underway.



 **CAUTION**

AVOID POSSIBLE BODILY INJURY
OR DEATH DUE TO FALLING!
THE STARBOARD BOARDING STEPS
ARE FOR EMBARKING ONLY!
USE HAND HOLDS!
DO NOT OCCUPY OR USE
BOARDING STEPS WHEN UNDERWAY!

Required Safety Equipment

Personal Flotation Devices:

All personal flotation devices (PFD's) must be Coast Guard approved, in good working condition, and must be the correct size for the wearer. All PFD's must be readily accessible. This means being able to wear them in a reasonable amount of time in case of an emergency (fire, boat sinking, etc.). They should not be stored or locked in closed areas. Also, make sure that all coverings are removed such as plastic from any PFD's. Throw-able devices such as a ring buoy need to be available for immediate deployment. A PFD should be worn at all times when your boat is operating on the water. A PFD may save your life, but it must be worn to do so.

As a minimum U. S. Coast Guard requirement all recreational boats must carry one type I, II, III, or V PFD (wearable) for each person aboard. See the explanation following for each type. For type V to be counted they must be used according to the label instructions. In addition, all boats over 16' must carry one Type IV (throw-able) PFD.

Some states require that PFD's be worn by children of specific ages at all times. Check with local and state boating agencies for particular requirements in your state before taking children on the water. Child life jackets are classified by the child's weight and should like all life jackets be sized before being purchased.

Remember PFD's will not necessarily keep you from drowning, even though they are designed to keep a person from sinking. When purchasing

PFD's make sure it safely fits the person wearing it. It is a good idea to test PFD's in a life guarded shallow pool before venturing on the water.

Refer to the USCG minimum equipment requirements at the end of this chapter. It is meant to be a guide only. Contact state and local agencies for additional equipment requirements. Remember as the captain of your vessel you are responsible for its safe operation.



Type I:

Also known as an off-shore jacket, it provides the most buoyancy. It is a PFD for all waters and is especially useful in rough waters where rescue may encompass additional time. It is designed to turn most unconscious users in the water to a true face-up position. Type I PFD is available in adult & child sizes. Buoyancy minimum poundages are 15.5 adult, 11 medium child, and 7 for small child and infants.

Type II:

Also known as near-shore buoyant vest, it is recommended for calm, inland water where rescue time will be minimal. It will turn some unconscious people face-up in the water but not as numerous as Type I. They are available in adult, medium child, along with infant and small child sizes.

Type III:

Known as a flotation aid it is good for calm, inland water or where there is a chance for quick rescue. It is designed so wearers can place themselves in a face-up position in the water. The wearer may have to tilt their head back to avoid face-down positions. Type III offer the same buoyancy minimum poundages as the Type II. They are generally the most comfortable for continuous wear. Float coats, fishing vests, and vests featuring designs for various sport activities are examples of Type III.

Type IV:

Intended for calm, inland water with heavy vessel traffic, where help is constantly present. It is designed to be thrown into the water for someone to grab on to and held until rescued. It is not designed to be worn. Type IV includes ring buoys, buoyant cushions, and horseshoe buoys.

Type V:

Also known as a special use device this is the least bulky of all PFD's. It contains a small amount of inherent buoyancy, and an inflatable chamber. It is rated even to a Type I, II, or III PFD (as noted on the jacket label) when inflated. Some Type V devices provide significant hypothermia protection. Varieties include deck suits, work vests, board sailing vests and Hybrid PFD's. Remember that this Type V type PFD may be carried instead of another PFD only if used according to the approval condition on the label.

Note: A water skier or wake boarder is considered on board the vessel and a PFD is required for the purposes of compliance with the PFD carriage requirements. It is advisable and recommended for a skier or wake boarder to wear a PFD designed to withstand the impact of hitting the water at a high speed. "Impact Class" marking on the label refers to PDF strength, not personal protection. Some state laws require a skier or wake boarder to wear a PFD.



PFD's For Pets:

If you are a skipper who needs to have his pet dog or cat on board or dock side then a PFD is recommended. The PFD will aid you in finding the pet if it should fall overboard. The device must fit the pet properly. Also, it may take a bit of training before the pet is comfortable wearing the PFD. Normally, dogs are easier to train wearing a life vest than a cat. Marine type retail stores will fit a pet to a PFD by body weight.

Maintaining Your PFD's

A PFD is only useful if it is well maintained. Always be aware of PFD age since it has a life expectancy like any other piece of equipment.

- √ Check periodically for broken zippers, frayed webbing, water soaked kapok bags, missing straps, and sewing that has become undone.

- √ Clean each PFD with mild soap and water only. Again, let dry sufficiently before storing.

- √ Keep PFD's out of grease and oil since they can deteriorate the jacket inner and outer materials.

- √ Check any kapok-bagged jackets by squeezing. If you hear air escaping the bag is defective and the PFD should be thrown away.

- √ Grab the cover with the fingers. If the cover material rips, the PFD is rotted and should be thrown away.

Fire Extinguishers

General Information:

Fire extinguishers are classified by a letter and numeric symbol. The letter references the type of fire the unit is designed to extinguish.

For example, type B extinguishers commonly used on boats are designed to put out flammable liquids such as grease, oil and gasoline.

The number indicates the general size of the extinguisher (minimum extinguishing agent weight).

Coast Guard Approved extinguishers are identified by the following marking on the label:

"Marine Type USCG Approved, Size..., Type..., 162.028/.../", etc.

MINIMUM PORTABLE FIRE EXTINGUISHERS REQUIRED		
VESSEL LENGTH	NO FIXED SYSTEM	WITH FIXED SYSTEM
LESS THAN 26'	1 B-I	0
26' TO LESS THAN 40'	2 B-I or 1 B-II	1 B-I
40' TO 65'	3 B-I or 1 B-I & 1 B-II	2 B-I or 1 B-II

FIRE EXTINGUISHER CONTENTS

CLASS	FOAM IN GALS.	CO2 IN LBS.	DRY CHEM IN LBS.	HALON IN LBS.
B-I	1.25	4	2	2.5
B-II	2.5	15	10	10

U. S. Coast Guard approved fire extinguishers are required on all Regal boats. Besides the minimum Coast Guard requirements always check state and local agencies for additional requirements and equipment.

Coast Guard approved extinguishers are hand-portable, either B-I or B-II classification. U. S. Coast Guard approved hand-portable and semi-portable extinguishers contain a metal plate that shows the manufacturers name and extinguisher type, capacity and operating instructions. They have a special marine type mounting bracket which keeps the extinguisher solidly mounted until needed. The extinguisher needs to be mounted in a readily accessible location but one that will not be bumped by people while underway. All approved extinguishers shall have an indication gauge.

U.S.C.G Approved Fire Extinguisher Types & Features:



The dry chemical agent is widely used because of its convenience and low cost. The extinguisher canister is filled with a white dry chemical powder along with a pressurized gas. It is a good idea to shake this type periodically because they tend to "pack" on the canister bottom.

The foam type uses a chemical foaming agent plus water and is best when used for fires involving flammable liquids- solvents, gasoline, oil, grease and various paints. It will work on fires involving rubber, plastics, cloth, wood, and paper. It leaves a messy residue. Do not use this extinguisher for electric fires.



The foam type uses a chemical foaming agent plus water and is best when used for fires involving flammable liquids- solvents, gasoline, oil, grease and various paints. It will work on fires involving rubber, plastics, cloth, wood, and paper. It leaves a messy residue. Do not use this extinguisher for electric fires.



The carbon dioxide unit uses CO₂ gas under high pressure, with a funnel discharge hose usually swivel mounted. This extinguisher leaves no

residue and does not cause interior engine harm. To ensure workability, weigh the unit annually. A 10% maximum weight variance is allowed.

Another type of liquefied gas used today is FE-241. This gas is colorless and odorless, heavier than air and sinks to the lower bilge to extinguish fires. Since the year 2000 ingredients have changed to a more environmental friendly formula (Chlorotetrafluoroethane or FE-241). FE-241 is used in portable-hand units along with making up the majority of boat automatic fire extinguishing systems. The canister needs to be weighed once a year. These clean agent units feature a dash mount indicator. Refer to the information regarding fire prevention in this manual.

Pyrotechnic Devices:

Pyrotechnic visual distress signals must be Coast Guard approved, be ready for service and must be readily accessible. They all display a marking which is the service life, which must not have expired. A minimum of 3 devices are required for the day and 3 devices for night.

Some devices meet both day and night requirements. Pyrotechnic devices should be stored in a cool, dry location. Most of these devices can be purchased in an highly visible (orange) watertight container. Types of Coast Guard approved pyrotechnic distress signals and associated devices are:

- Pyrotechnic red flares, hand-held or aerial type.
- Pyrotechnic orange smoke, hand-held or floating type.
- Launchers for parachute flares or aerial red meteors.

All in all, each distress signal has certain advantages and disadvantages.

There is no distress signal that is best under all situations. Pyrotechnics are recognized worldwide as superior distress signals. A downfall is they emit a very hot flame that can cause burns and or ignite flammable materials. Pistol launched and hand-held parachute flares operate consistent with firearms and therefore must be carefully handled. Check with local and state regulations since some of these device are considered firearms and are prohibited.

It is best to carry red aerial flares which are visible from a greater distance. Also, the red parachute flares burn for longer periods and therefore are more likely to be seen by another vessel.

Non-Pyrotechnic Devices:

Non-pyrotechnic devices must all be in serviceable condition, readily accessible, and must be certified by the manufacturer to comply with U. S .C. G standards. They include:

- Orange distress flag.
- Electric distress light.

The distress flag is for day use only. It must be 3 x 3 or larger with a black square and ball on an orange background. It can be spotted when attached to a boat hook, long fishing rod, or paddle with the person waving the flag back and forth overhead.

The electric distress light is for night use only flashing the international SOS distress signal (... _ _ _ ...).

Under Inland Navigation Rules, a high intensity white light that flashes at regular intervals from 50-70 times per minute is considered a distress signal.

Remember that regulations prohibit the display of visual distress signals on the water under any circumstances except when assistance is required to prevent immediate or potential danger to passengers on a vessel.

International Distress Signals



BLACK SQUARE
AND BALL ON
ORANGE BACKGROUND



CODE FLAGS
NOVEMBER
& CHARLIE



SQUARE FLAG
& BALL



PERSON
WAVING
HANDS

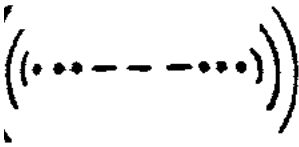

MORSE
CODE S.O.S.



"MAYDAY"
BY
RADIO

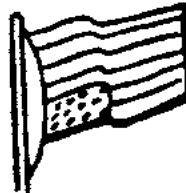

ENSIGN
UPSIDE
DOWN



PARACHUTE
RED FLARE



RED METEOR
FLARES



SMOKE



FOG HORN
SOUNDED
CONTINUOUSLY

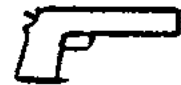

GUN FIRED AT
1- MINUTE
INTERVALS

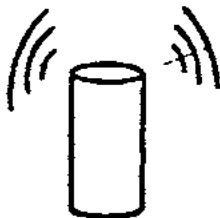

POSITION
INDICATING
RADIO BEACON



DYE MARKER
(ANY COLOR)



HAND-HELD
FLARE

Sound Producing Devices

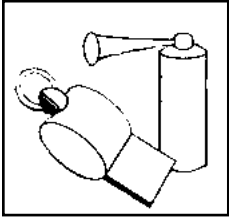

According to both Inland and International Rules, all boats must carry a way of producing an efficient sound signal. If your vessel is 12 meters (39' 4") or longer, a power whistle or power horn and bell must be carried. Bell mouth must be at least 7 7/8" diameter. The sound signal made in all cases must be capable of a four or six second blast audible for one half mile. See the section discussing bridge and whistle signals for more information.

Radio Communications:

VHF radios are used for distress and ship to shore and ship to ship communications today. Learn the specialized messages such as Mayday, Mayday, Mayday. It is only used when life or vessel is in imminent danger.



Many of the more recent VHF's feature DSC capability which offers the ability to place and receive digital calls directly with vessels and shore stations including USA and Canadian Coast Guards. Channel 70 is reserved exclusively for DSC calls. Refer to the VHF owner's information since you need to establish a Mobile Maritime Safety Identity (MMSI) number before using the DSC feature. A MMSI number identifies each DSC radio, like a telephone number. The FCC requires a ship station license for all vessels equipped with a marine VHF radio.

Navigation Lights:

The U. S. Coast Guard requires recreational boats operating at night to display navigation lights between sunset and sunrise along with other periods of reduced visibility.

Navigation lights help avoid collisions by improving the night visibility of vessels. Red and green directional lights, white stern lights, white masthead lights and white all-around lights must be displayed in specified positions, depending on boat size, and mode of operation.

Marine Sanitation Devices:

Recreational vessels under 65' with installed toilet facilities must have an operable marine sanitation device (MSD) on board. Vessels 65' and under may use Type I, II, or III MSD's. All installed MSD's must be U.S. Coast Guard certified. The MSD's are labeled to show conformity to the regulations.

Navigation Rules:

The navigation rules establish actions to be taken by vessels to avoid collision. They are divided into Inland/International. Operators of vessels 39.4' or more shall have on board and maintain a copy of the Inland navigation rules.

Navigation Light Rules

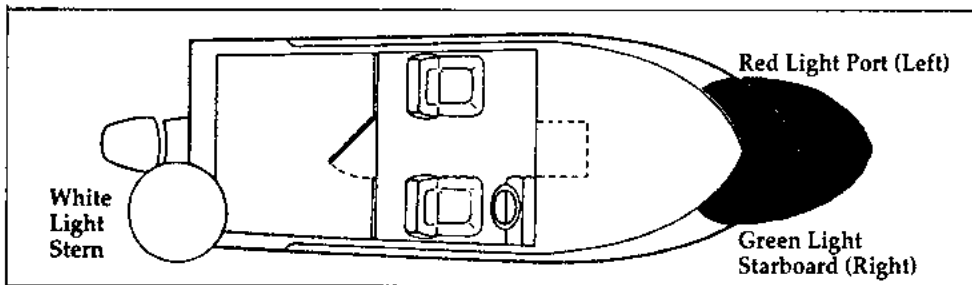

Location of lights on vessel	Visible Range		Degrees of arc lights
	Less than 12 m.	12 m. but less than 20 m.	
Masthead	2	3	225°
All-round	2	2	360°
Side lights	1	2	112.5° each color
Stern light	2	2	135°

Boats less than 12 meters in length

Motorboats or sailboats using power: The lighting arrangements to figure 1, 2 or 3 may be used.

Sailboat using sails alone: The lighting arrangements in figure 4, 5 or 6 may be used.

Boats 12 meters but less than 20 meters in length

Motorboats or sailboats using power: The lighting arrangements to figure 1 or 2 may be used.

Sailboat using sails alone: The lighting arrangements in figure 4, 5 or 6 may be used.

Location of lights

Lights should be located as shown in the drawings.

The masthead light (forward white light in figures 1, 2 and 7d) must be at least one meter higher than the colored lights on a boat less than 12 meters in length and at least 2.5 meters above the gunwale on a boat 12 meters but less than 20 meters in length.

Exceptions

Motorboat or sailboat using power, built before December 24, 1980: The lighting arrangement in figure 1, 2 or 3 may be used. However, the arrangement in figure 3 is not acceptable on a boat that is 12 meters or longer on international waters.

figure 1

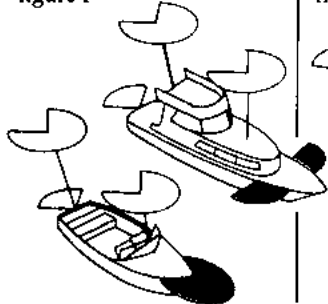

figure 2

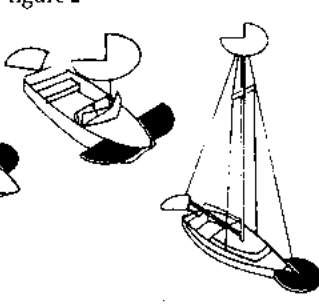

figure 3

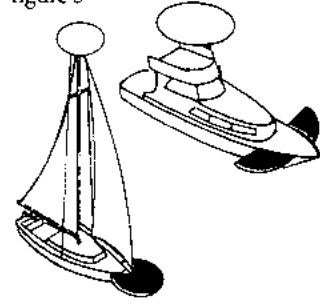

figure 4

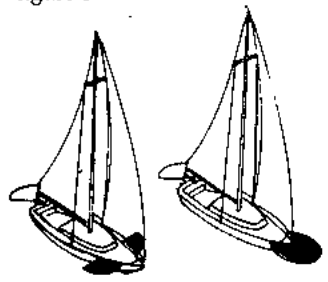

figure 5

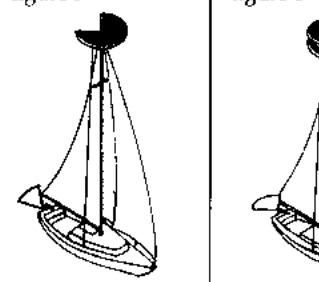

figure 6

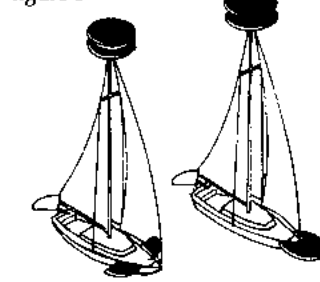
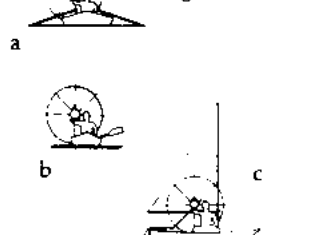

figure 7



Sailboat using sail alone, less than 7 meters in length: If impractical to display lights in figure 4, 5 or 6, a single white light may be displayed in time to prevent a collision (figure 7c).

Row Boats or Paddle Boats
One all-round white light ready to display in time to prevent a collision (figure 7 a or b).

Great Lakes

figure 7d



Motorboat or sailboat using power on Great Lakes: The lighting arrangements in figure 7d may be used instead of the arrangements in figures 1 and 2.

DISCHARGE OF OIL PROHIBITED

THE FEDERAL WATER POLLUTION CONTROL ACT PROHIBITS THE DISCHARGE OF OIL OR OILY WASTE INTO OR UPON THE NAVIGABLE WATERS OF THE UNITED STATES, OR THE WATERS OF THE CONTIGUOUS ZONE, OR WHICH MAY AFFECT NATURAL RESOURCES BELONGING TO, APPERTAINING TO, OR UNDER THE EXCLUSIVE MANAGEMENT AUTHORITY OF THE UNITED STATES, IF SUCH DISCHARGE CAUSES A FILM OR DISCOLORATION OF THE SURFACE OF THE WATER OR CAUSES A SLUDGE OR EMULSION BENEATH THE SURFACE OF THE WATER. VIOLATORS ARE SUBJECT TO SUBSTANTIAL CIVIL PENALTIES AND/OR CRIMINAL SANCTIONS INCLUDING FINES AND IMPRISONMENT.

Marpol Treaty:

The USCG now enforces the International Convention for the Prevention of Pollution from ships, referred to commonly as the MARPOL TREATY (marine pollution). This international treaty prohibits the overboard dumping of all oil, garbage, ship-generated plastic and chemicals. There is a placard on board your boat (typical example shown below) that explains the garbage and plastic dumping laws in detail.

Immediately notify the USCG if your vessel discharges oil or hazardous substances in the water. Call toll free 1-800-424-8802. Report the following information: location, source, size, color, substances and time observed.

No vessel may intentionally drain oil or oily waste from any source into the bilge of any vessel. A

bucket or bailer is suitable as a portable means of discharging oily waste.

The placard noted above is normally located in the engine compartment or may be attached to the engine hatch.

Garbage Discharge

THE DISCHARGE OF PLASTIC OR GARBAGE WITH PLASTIC INTO ANY WATERS IS PROHIBITED. THE DISCHARGE OF ALL GARBAGE IS PROHIBITED IN THE NAVIGABLE WATERS OF THE UNITED STATES AND IN ALL OTHER WATERS, WITHIN THREE NAUTICAL MILES OF THE NEAREST LAND.

THE DISCHARGE OF DUNNAGE, LINING, AND PACKING MATERIALS THAT FLOAT IS PROHIBITED WITHIN 25 NAUTICAL MILES FROM THE NEAREST LAND.

OTHER UNGROUND GARBAGE MAY BE DISCHARGED BEYOND 12 NAUTICAL MILES FROM THE NEAREST LAND.

OTHER GARBAGE GREATER THAN ONE INCH TO LESS THAN ONE INCH MAY BE DISCHARGED BEYOND THREE NAUTICAL MILES FROM THE NEAREST LAND.

A PERSON WHO VIOLATES THE ABOVE REQUIREMENTS IS LIABLE FOR A CIVIL PENALTY OF UP TO \$25,000, A FINE OF UP TO \$50,000, AND IMPRISONMENT FOR UP TO FIVE YEARS FOR EACH VIOLATION, REGIONAL, STATE, AND LOCAL RESTRICTIONS ON GARBAGE DISCHARGES MAY ALSO APPLY.

The act to prevent pollution from ships places limitations on the discharge of garbage from vessels. It is illegal to dump plastic trash anywhere in the ocean or navigable waters of the United States. Also, it is illegal to discharge garbage in the navigable waters of the United States, including the Great Lakes. The discharge of other types of garbage is allowed outside certain specified distances from shore as determined by the nature of that garbage.

United States vessels of 26 feet or longer must display in a prominent location, a durable placard at least 4" x 9" notifying crew and passengers of discharge restrictions.

USA vessels of 26' or longer equipped with a galley and berthing must have a written Management Plan describing the plan for collecting, processing, storing and discharging garbage, and designate the person charged with carrying out the plan.

The placard noted below is usually found near a galley, inside the engine hatch area or close to a receptacle.

USCG Minimum Equipment Requirements

Use the chart below as a guideline for assuring your vessel is outfitted to meet USCG standards. Remember to check with local and state authorities for additional equipment requirements. Make sure your vessel certificate of numbers are on the boat, updated and displayed properly according to state requirements. Keep the paperwork on board in a watertight and safe environment. On documented vessels keep both the original and current certificate on board stored in a safe, dry, and accessible location. Also, on documented vessels make sure the vessel name/hailing port are marked on the hull exterior with letters not less than 4" in height. In addition, the Official Number must be permanently affixed on a clearly visible interior structure part of the boat-block type Arabic numbers not less than 3" in height.

Life Rafts



Inflatable life rafts are recommended for ocean going and vessels operating in a large body of water like the Great Lakes. They provide a shelter for extended periods. If used, make sure it is large enough for all aboard and contains the proper emergency equipment pack. Also, periodically have the unit professionally serviced. Make sure the life raft is Coast Guard approved since it would require meeting a number of stringent material and performance standards.

USCG Minimum Equipment Requirements for Recreational Vessels					
Boat Size in Feet	16'	26'	40'	65'	165'
Personal Flotation Devices ¹	One Type I, II, III, or V per person		One Type I, II, III, or V per person plus one Type IV throwable		
Fire Extinguishers ²	One B-I, any type		One B-II or Two B-I	One B-II and one B-I, or three B-I	One or more B-II (vessels 0-50 tons gross) Two or more B-II (vessels 50-100 tons gross)
No Fixed System			One B-I	Two B-I or one Class B-II	
With Fixed System	No Portables Required		One B-I	Two B-I or one Class B-II	
Visual Distress Signals	Night signals required when operating at night		Minimum of three day-use and three night-use (or three day/night combination) pyrotechnic devices ⁵		
Sound Producing Devices	Horn or whistle recommended to signal intentions or signal position		One bell, and one whistle or horn required to signal intentions or position		
Backfire Flame Arrestor	One CG-approved device on each carburetor of all gasoline-powered engines built after April 1940, except outboard motors				
Ventilation	CG standard system required on gasoline powered vessels with enclosed engine compartments built after August 1980				
Navigation Lights	Under Power ^{3,4}				
Under Sail	Sidelights, Stern Light and Masthead ^{6,7}				
Rowing	Sidelights and Stern Light ^{6,8}				
At Anchor	Same as "Under Sail"				
Visibility Range	All-round light, 2nm (at night) or black anchoring ball (during the day) when outside a designated anchorage		1nm Sidelights, 2nm all others		3nm Masthead, 2nm all others
Pollution	"Honor system" (no plaques required)		5" x 8" Oil Discharge placard and 4" x 9" Waste Discharge placard		
Regulations			Vessels over 40' with a galley must have a Waste Management Plan		
Marine Sanitation Devices	Vessels with installed toilet facilities must have an operable, CG-certified Type I, II or III Marine Sanitation Device (MSD). Subject to local laws!			Type II or III MSD only	
Navigation Rules	Familiarity with the Inland Navigation Rules required			The Inland Navigation Rules ("Rules of the Road") must be kept on board	

1. PFD's must be CG approved, wearable by the intended user and readily accessible.	5. Non-pyrotechnic substitutes: 1 orange distress flag (day-use) and 1 electric SOS signal light (night-use).
2. Fire extinguishers required on boats with enclosed engine compartments (not outboards), enclosed living spaces or permanent fuel tanks.	6. All boats under 65' can substitute a single bi-color light for sidelights.
3. Sailboats operating under engine power are considered power driven and must follow the "Under Power" rules. During the day, motorsailing vessels are required to fly a motoring cone.	7. Boats under power under 40' can substitute a single all-round light for separate stern and masthead lights.
4. Power-driven vessels under 25' and under 7 knots can substitute a white lantern or torch in place of the required lights.	8. Boats under sail under 40' can substitute a tri-color light for separate sidelights and stern light.

Additions to these requirements are prescribed by some individual state laws. Check your state's Boating Safety Handbook for a complete list.

Exhaust & Carbon Monoxide

Carbon monoxide (CO) in exhaust can be hazardous, especially from gasoline engines, gasoline generators, grills, stoves, space heaters and on a much smaller degree diesel engines.

CO is a natural by-product of the gasoline engine using an artificial spark. Diesels on the other hand detonate fuel using pressure and temperature. Looking at the two engines another way, gasoline engines use much more oxygen up in the combustion process which contributes to a much higher CO build-up. Although diesels do produce a small amount of CO the combustion process operates with much greater amounts of oxygen which the end result is a much lower CO level.

Ensure that you read the information and follow all the recommendations regarding CO.

Familiarize your crew, passengers and yourself with the sources, symptoms and possible effects of carbon monoxide poisoning. Remember that boats in the same general vicinity can cause your vessel to accumulate dangerous CO levels in the cabin and or in the cockpit.

 **WARNING**

AVOID SERIOUS INJURY OR DEATH
FROM CO POISONING!
DO NOT OPERATE THE BOAT WITH PEOPLE
HOLDING ON TO THE SWIM PLATFORM
OR WITH PEOPLE IN THE WATER.

For safety sake avoid the following:

1. Do not park by other boats with their engine idling or generator cycling for an extended period of time.
2. Do not disable the carbon monoxide alarms that come with your Regal boat. Test the units in accordance with the alarm manufacturers instructions.
3. Do not operate an engine for extended periods of time while in a confined area or where exhaust outlets face a sea wall or bulkhead.
4. Do not operate the engine for an extended period of time with the canvas in the upright and installed position.
5. Do have the engine exhaust system inspected when the boat is in for service.
6. Persons sleeping can easily be overcome by carbon monoxide without realizing it. Do not sleep on board while an engine or generator is running close-by.
7. Do not operate your vessel for extended periods with the bow up in slow cruise conditions especially close behind a vessel being towed or one operating at slow speeds.
8. When underway open all hatches, windshield vents, and main cabin entry door to allow proper airflow from bow to stern.

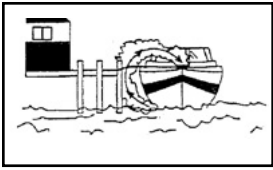

Blockage of exhaust outlets can cause carbon monoxide to accumulate in the cabin and cockpit area even

when the hatches, windows, portholes and doors are open. Sea walls and other confined spaces can cause CO levels to be dangerously elevated.

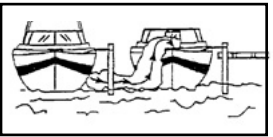

Exhaust from another vessel alongside your boat, while docked or anchored, can

emit poisonous CO gas inside the cabin and cockpit areas.

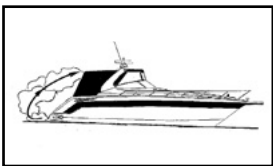

The “station wagon effect” or back drafting can cause CO gas to accumulate inside the cabin, cockpit/

hardtop or bridge areas when the boat is underway, using protective weather coverings (canvas), high bow angle, improper or heavy loading, slow speeds, or at rest. This can occur when traveling behind another boat.

How does CO affect us?

In high concentrations, CO can be fatal in minutes. However, the effects of lower concentrations over a extended period of time can be just as lethal.

Our blood uses hemoglobin to carry the oxygen we breathe to different body parts. Unfortunately, hemoglobin carries CO more readily than it does oxygen. The result is when we breathe in CO it replaces oxygen in our blood and we begin to suffocate. Also, when we are removed from the CO source it remains in our blood for hours causing long term effects. People have been known to become sick and even lose consciousness hours after exposure.

Carbon monoxide accumulation requires immediate attention! Thoroughly ventilate cabin and cockpit areas. Determine the probable source of the carbon monoxide and correct the condition immediately. Anyone with symptoms of CO poisoning should be placed in a fresh air environment and medical attention found immediately. Regal has installed CO detectors on your boat. Have these detectors professionally calibrated at regular intervals according to the manufacturer’s recommendations.

A Few Notes About Diesel/CO Poisoning

The diesel engine under normal combustion produces much smaller amounts of CO. Therefore, it is far less likely to be fatal to a healthy person. Other factors including weather, temperature and engine condition can greatly affect the unsafe build-up of CO. The best approach is to respect and treat the engine, generator and other vessel components the same way you would a gasoline propulsion system giving particular attention to the sources and possible effects of CO poisoning!

Diesel exhaust in the combustion process produces various components and the captain must be aware that the build-up of these select components over a period of time can cause CO or seasickness like symptoms. These include carbon dioxide, carbon monoxide (CO), nitrogen dioxide, nitric oxide, sulfur dioxide and others. Be careful with boats mooring with engine/generator running overnight. A healthy person breathing in sulfur dioxide over a period of time through a diesel engine or generator exhaust can develop nausea. This condition is not life threatening but the person may exhibit CO poisoning or seasickness symptoms. Just never rule out that it could be CO poisoning! Immediately find the source of the problem and move the individual to fresh air.

Symptoms of excessive exposure to carbon monoxide (CO) are:

- Dizziness
- Drowsiness
- Nausea
- Headache
- Ringing in the ears
- Throbbing temples
- Watering, itchy eyes
- Flushed appearance
- Inattentiveness
- Incoherence
- Fatigue or vomiting
- Convulsions

! DANGER

CARBON MONOXIDE IS A TASTELESS, ODORLESS AND INVISIBLE GAS THAT CAN CAUSE DISCOMFORT, SEVERE ILLNESS, AND EVEN DEATH. EXERCISE CAUTION WHILE OPERATING GENERATOR OR ENGINES IN CONFINED SPACES OR AT DOCK SIDE. DO NOT ALLOW HULL EXHAUST OUTLETS TO BECOME BLOCKED OR EXHAUST FUMES CAN BECOME TRAPPED IN AND AROUND THE CONFINES OF YOUR BOAT. DURING IDLE AND SLOW CRUISE CONDITIONS, BILGE BLOWERS SHOULD BE USED.

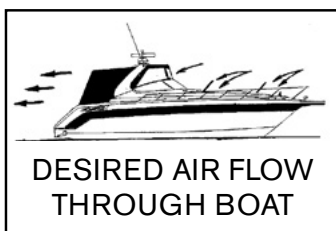

To help prevent carbon monoxide (CO) accumulation, ventilate your cabin and cockpit while

underway. Open a forward hatch, porthole or window to allow air to travel through the boat's interior and cockpit. See the illustration for desired airflow.

NOTE: Never occupy moored boat with engines running and/or canvas completely covering vessel.

! WARNING

INSPECT THE EXHAUST SYSTEM. IMMEDIATELY REPAIR OR REPLACE LEAKING, CRACKED AND CORRODED, OR MISSING EXHAUST COMPONENTS.

- Before each trip inspect engine, generator and all CO detectors. All must be working properly.
- Make sure all exhaust hose clamps are in place.
- Look for exhaust leaking from the exhaust system components, indicated by rust and or black streaking, water leaks, or corroded or cracked fittings.
- Inspect all rubber exhaust hoses for burned or cracked areas. All rubber hoses should feel soft and and be free of kinks.
- Visually verify that water exits at the engine exhaust outlet.
- Keep an ear tuned for changes in exhaust sound that may be an exhaust component malfunction.

Do Not Operate the Vessel If **Any** of the above conditions exist. Contact a marine professional!

NOTICE

CARBON MONOXIDE PRECAUTIONARY LABELS ARE LOCATED AT THE HELM, TRANSOM AND CABIN. ENSURE THAT ALL ABOARD READ AND UNDERSTAND THE SIGNS AND EFFECTS OF CARBON MONOXIDE (CO).

Boating & Alcohol



Operating a vessel while intoxicated became a specific federal offense effective in 1988. The ruling set federal standards for determining

when an individual is intoxicated. If the blood alcohol content (BAC) is .10% (.08 in some states) or higher for operators of recreational vessels being used only for pleasure are subject to a civil penalty up to \$1,000 or criminal penalty up to \$5,000, one year imprisonment or both. In some states the fines and imprisonment may increase significantly.

The effects of alcohol and drugs account for the highest single cause of marine accidents and deaths. Most deaths in boating accidents occur when someone falls into the water. Balance is one of the first things you lose when drinking alcohol or under the influence of drugs. The problem arises out of not knowing your balance is restricted.

Overall vision is reduced by alcohol especially at night, along with double or blurred vision. Peripheral vision is lessened which restricts seeing vessels or objects on the side. Also, color awareness decreases especially with red and green which happen to be the colors of boat navigation lights, buoys, and channel markers.

Alcohol will greatly increase your heat loss so it increases the effects of hypothermia. Finally, your ability to make correct judgements in emergency situations is greatly reduced. Alcohol takes away the brains ability to process information quickly and delays a persons reaction time.

Don't drink and drive!

Alcohol Myths & Facts:

Myth: Beer is less intoxicating than other alcoholic beverages.

Fact: One 12 oz. can of beer has about the same amount of alcohol as a 5oz. glass of wine or a shot of liquor.

Myth: Black coffee, fresh air, and a shower will sober the effects of alcohol.

Fact: After consuming alcohol time is the only thing that will sober you up. Our bodies average burning 1 oz. of alcohol every hour. If a person is drunk, it will take a person seven or more hours to sober up.

Myth: Telling if a person is too drunk to operate a vessel is easy.

Fact: Many experienced drinkers have learned to compensate for the visual effects of alcohol and can disguise their drunk condition.

Myth: You can judge if you are fit to operate a boat.

Fact: Judgement is one of the first elements you lose when drinking.

Boating Accidents

The following is a list of common causes of boating accidents. Be aware of them and take the necessary steps to ensure that yourself and crew are educated and prepared to act in an emergency.

1. Mixing boating and alcohol. Remember, the skipper is responsible for his crew, passengers and vessel.
2. Trying to reach the bow by the deck walk-around at unsafe speeds. Use the center walk-through.
3. Someone sitting on the bow, deck, or swim platform while underway.
4. Choosing a boating outing day with inclement weather, especially in high winds and thunderstorms in the forecast or staying out when bad weather is approaching.
5. Disembarking without checking all the fluids or systems, and especially fuel system components.
6. Not monitoring the boating traffic or possible obstructions around you.
7. Emergency communications equipment, signaling devices, and navigation lights not working.
8. Improper boat handling especially high speed turns in rough water. Using trim improperly.
9. Being too far from shore with inadequate fuel supply or navigational aids.

10. Passengers, especially children that are not wearing the proper life saving devices.
11. Skipper or passengers not seated in the boat.

Reporting Boating Accidents:

According to the Federal Boat Safety Act of 1971 involving collision, accident or other casualty, the operator must make a formal report within 48 hours to the nearest state boating authority when the incident involves:

1. Death
2. Injury requiring treatment other than first aid
3. The disappearance of someone from a boat under death or injury circumstances.

A formal report must be made within 10 days for accidents involving more than \$2000 damage or complete loss of vessel.

For information regarding accident reporting, please call the Boating Safety Hot-line at: 800-368-5647.

Note if there is no state provision for reporting boating accidents a report must be made to the Coast Guard officer in charge, Marine Inspection Unit nearest to the accident site or USCG station.

Federal Regulations- Vessel Security

Federal maritime regulations contain specific information when operating near naval vessels, oil tankers and cruise ships.

1. You may not approach within 100 yards of any U.S. naval vessel, oil tanker, or cruise ship. When this is impossible to avoid, you must contact either the vessel or the Coast Guard escort vessel on channel 16 of the VHF radio.
2. Also, you must operate at minimum speed within 500 yards of these vessels.



WARNING

Do not approach within 100 yards of any U.S. naval vessel. If you need to pass within 100 yards of a U.S. naval vessel in order to ensure a safe passage in accordance with the Navigation Rules, you must contact the U.S. naval vessel or the Coast Guard escort vessel on VHF-FM channel 16.



OPERATE AT MINIMUM SPEED

You must operate at minimum speed within 500 yards of any U.S. naval vessel and proceed as directed by the Commanding Officer or the official patrol.

Violations of the Naval Vessel Protection Zone are a felony offense, punishable by up to 6 years in prison and/or up to \$250,000 in fines

Rendering Assistance

The operator of a vessel is obligated by law to provide assistance that can be provided safely to any individuals in a dangerous situation on the waterway. The operator is subject to fine and or imprisonment for failure to do so.



DANGER

AVOID BODILY INJURY OR DEATH FROM FALLING OVERBOARD! ALL OCCUPANTS SHALL STAY SEATED IN THE COCKPIT WHILE THE BOAT IS RUNNING.

Water Sports

Besides learning the safety precautions for safe boating, as well as understanding and knowing required rules and regulations you are obligated to be particularly careful around other water sportsman, such as scuba divers, water skiers, wake boarders, and fisherman.



Whenever you see a “Diver Down” flag maintain a distance of at least 100 feet on inland waters. In bays and

open waters stay 300 feet away. The flag indicates a diver in the water. If a diver is operating from your boat, be certain to use this flag and post a lookout on board to observe the diver’s air bubbles.

Fishing



Most boaters fish from time to time. With the propulsion systems of today it is possible to fish in out-of-the-way places. When cruising, stay clear of fisherman. They may have lines or nets out which might be cut or get caught in your propeller if you come too close. Slow down when approaching fishing boats. Do not return to cruising speed until the boats have been passed. If a fishing boat should be anchored, a large wake could flip or swamp the boat, upset fishing gear, pull the anchor loose from the bottom or worse yet cause someone to fall overboard.

When fishing from your boat, never anchor in a shipping channel or tie up to any navigational aid. These must be kept clear of at all times. Be sure to carry a local chart of the area to back up your plotter and be on the lookout for shallow water and hidden obstructions. Many times local conditions change and there is a time lag on the plotter chip until the next revision. Pick up a tidal chart if appropriate so you do not end up grounded.

Weather / Water Conditions

Before a boating outing check the weather conditions. As we all know the weather can change rapidly in many parts of the country. It does so sometimes without being predicted. NOAA weather radio reports are continuously available on designated frequencies installed on VHF radios and various hand held devices.

Also, many local radio stations carry weather reports along with on-line information.

Cloud Formations:

Clouds indicate the type of current weather and upcoming changes in the weather. Knowing the type of cloud formation can assist you in understanding current weather. Flat clouds (stratus) normally indicate stable air. Cumulus clouds indicate unstable air.

Many times a “cotton ball” or cumulus cloud builds vertical height in the afternoon and the result is a thunderstorm with increased winds and waves; sometimes these storms are quite violent.

Also, water spouts with high vortex winds can develop over water. You can find additional weather information (meteorology) at your local library or on the internet.

Waves & Fog:

As the wind blows across water waves are created. The stronger the wind and increased distance across the water enlarges the wave action. Other factors that can cause problem situations for vessels are fog, currents, and tidal changes.

Fog can develop inland on clear, calm mornings. Coastal areas see large “blankets” of fog roll in and stay for extended time periods sometimes causing hazardous navigation conditions. If you are caught in the fog, do not panic. Think of the best plan of action and proceed carefully. If you are limited in navigation equipment at the first sign of fog proceed to the nearest shoreline and wait until the fog lifts.

Boats equipped with navigation equipment, local waterway experience and charts should proceed to a safe harbor. Use extreme caution, signal as needed, and reduce to a speed where you can stop within half of your forward vision range.

If foul weather catches you at sea do the following:

1. Slow down. Proceed with caution and put on your life vests.
2. Try to reach the nearest safe shoreline.
3. Navigate your vessel slowly into the waves at a 45 degree angle.
4. Passengers should sit low in the center of the vessel.
5. Monitor your bilge pump. Make sure sump stays free of water.
6. Secure loose gear. Make ready emergency equipment.
7. Anchor over the bow but never over the stern.

Chapter 3

Rules Of The Road



The Navigation Rules set forth actions to be followed by boats to avoid collision. They are referred to as the “Rules of the Road”.

There are two main parts referred to as the inland and international rules. The inland rules apply to vessels operating inside the boundaries of the United States. The international rules (referred to as 72 COLREGS) apply to vessels operating on the high seas and all connected waters outside the established demarcation boundaries. Most navigational charts show the demarcation lines by red dotted lines and are published in the navigation rules. Remember to consult state and local agencies since areas such as “no wake zones,” swimming beaches, “diver down flag” and inland landlocked lakes fall under their responsibilities. This section is only an introduction to the “rules of the road”. We strongly recommend additional training before getting behind the “wheel”. Order Inland & International Navigation Rules from:

Superintendent of Documents
U. S. Government Printing Office
Washington, DC 20402
Tel: (202-512-1800) Fax:(202-512-2250)

 **WARNING**

TO AVOID INJURY AND DEATH
FOLLOW THE NAVIGATION “RULES OF THE
ROAD” TO PREVENT COLLISIONS.

Navigation Rules

Right Of Way:

1. Cross waves at right angles.
2. When caught in heavy water or squalls, head either directly into the waves or at a slight angle. Reduce speed, but maintain enough power to maneuver your boat safely.
3. Keep your speed under control. Respect the rights of other boaters engaged in all water sports. Give them plenty of operating room.
4. Whenever meeting a boat head on, keep to the right where possible.
5. When two boats cross, the boat to the right (starboard) has the right of way.
6. When overtaking or passing, the boat being passed has the right of way.
7. In general, boats with less maneuverability have right-of-way over more agile craft. The skipper must keep his craft clear of the following vessels:
8. A vessel not under command or aground; due to their circumstances, these vessels have no maneuverability.

9. A vessel restricted in its maneuverability; these vessels usually are performing work which limits their maneuverability. Examples are boats surveying, dredging, laying pipe or cable, or servicing navigational markers.
10. A vessel engaged in fishing; these include boats fishing with lines, trawls or nets, but not trolling lines.
11. Sailboats; they have the right-of-way over powerboats. However, if a sailboat is using a prop to move forward, it is considered a powerboat even if the sails are up.
12. Remember the unwritten "rule of tonnage". Basically a smaller tonnage vessel should take every effort to avoid close quarters with a larger tonnage vessel. One way to accomplish this is to have a designated human lookout to "eyeball" the horizon for any developing collision course.
13. Use defensive driving skills on the waterway just as you do on the roadway. The other vessel may not know the rules of the road. Be alert and ready to take immediate action.
14. If a collision course is unavoidable neither boat has the right of way. Both boats must react to avoid an accident according to the rules of the road.

Lookouts:

International and Inland navigation rules spell out the specifics of establishing a lookout. A lookout is legally defined by the court system as a person who has specifically charged duties on board such as observing sounds, echoes, lights and any inhibitors to navigation with complete thoroughness as permitted by the circumstances.

The term "specifically charged" means that the lookout has no other duties at that time that could prevent him from keeping a proper watch.

Of course the skipper must delegate the lookout duties to a seasoned crew member who can react to events quickly and communicate effectively with the captain with little notice.

As captain of your yacht you are responsible for the vessel and the crew. Choose an experienced individual as lookout and review the navigation rules with this person so he can make the right call quickly as situations develop.

WHISTLE SIGNALS

ONE LONG BLAST: Warning signal
(Coming out of slip)

ONE SHORT BLAST: Pass on my port side

TWO SHORT BLASTS: Pass on my starboard side

THREE SHORT BLASTS: Engine(s) in reverse

FOUR OR MORE BLASTS: Danger signal

BRIDGE SIGNALS

		DAY (Flag)	NIGHT (Lights)
SOUND	VISUAL		
VESSEL: Open	—●	□	○
BRIDGE: OK	—●	▽	●
	No ●●●●●	Same	or Same
VESSEL: Replies:	●●●●●		
RADIO: VHF CH. 13		No	◀●▶

Navigation Rules

The Navigation Rules set forth 3 types of crossing situations- crossing, meeting, and overtaking. In each case, both boats are governed by special procedures.

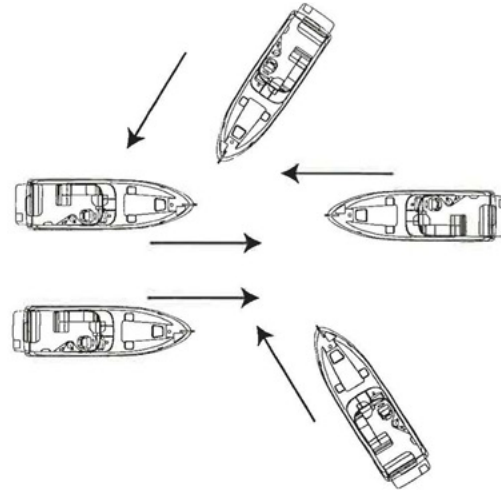

In a head-on meeting, both vessels must sound a single blast to give way toward starboard and pass to port.

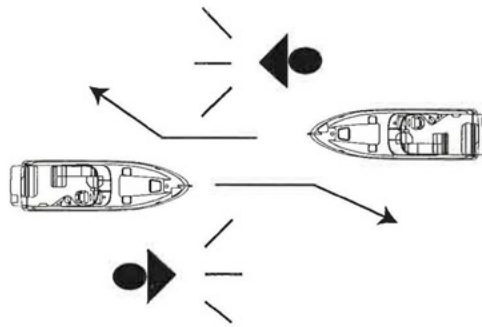

These rules appear when there is a risk of collision. In a crossing situation be aware of the other craft's position. For safety, there should be a noticeable change in the angle, bow or stern; a gradual change in position indicates possible danger.

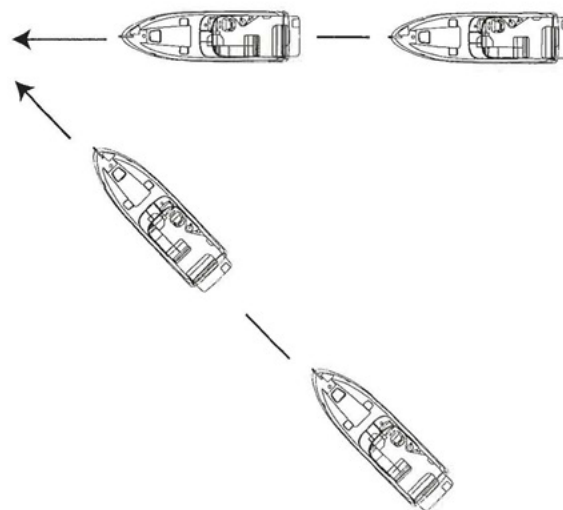

Navigation Rules

An overtaking boat is burdened, and is not the privileged craft, even though it approaches the danger zone of the overtaken boat.

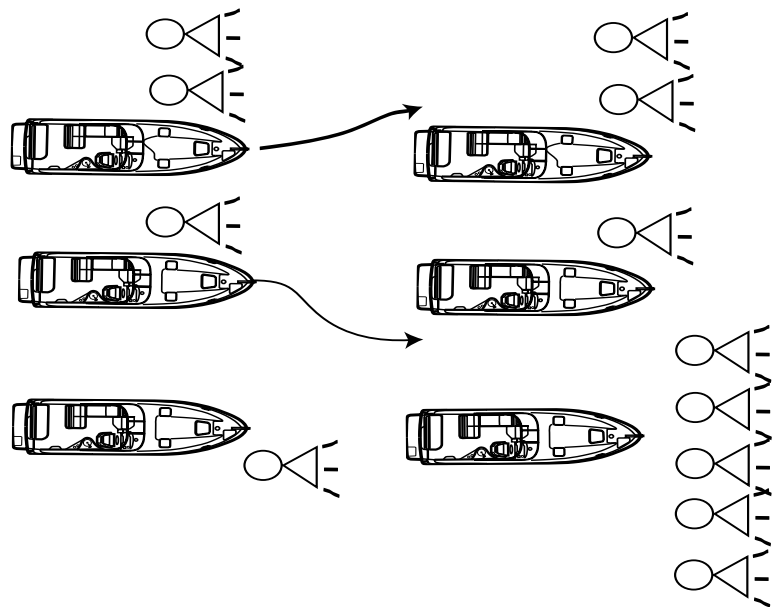
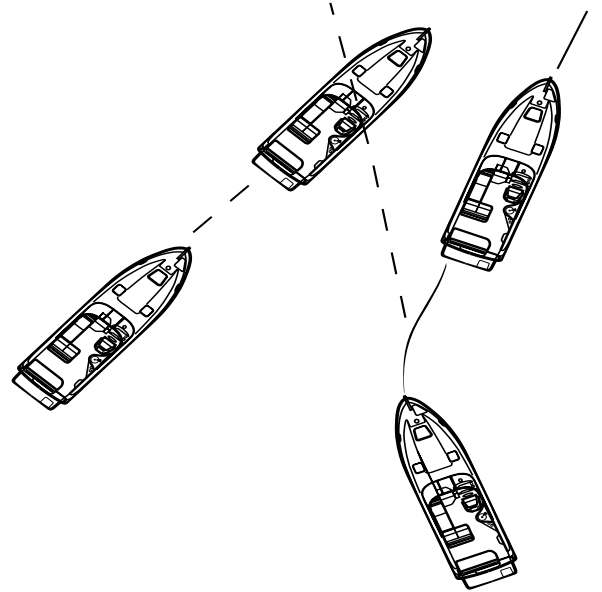

The overtaking boat first signals with a single blast if that boat desires to pass on the starboard side of the boat ahead, or a double blast if passing to port. The overtaken craft responds with the same signal if safe, or with the danger signal (5 short blasts or more) if unsafe. The boat overtaking must not pass unless the appropriate signals are sounded.

Navigation Aids

Navigation aids are placed along coasts and navigable waters as a guide for mariners in determining their position in reference to land and hidden danger. Each aid provides specific information. They form a continuous system of charted markers for monitoring on the plotter or providing accurate piloting on paper as a backup. Your on board plotter provides up to date navigation aids. Besides coastal maps a complete domestic interior waterway grid is featured on the plotter.

If desired, there are hand-held GPS devices that are available as back-up devices. In addition, nautical charts are provided by the National Ocean Service (NOS) and are distributed nationwide through marinas and outlet stores. These charts show the geography of the coast, water depth, landmarks, navigation aids (buoys and markers), marine hazards, and port facilities. Use only up-to-date charts for navigation. We recommend when purchasing a chart to look for the weather resistant ones. Buoys provide a road map to keep the skipper on course and to avoid hazards. Buoys are identified by light, shape, color and in severe weather conditions by sound.

Buoys or beacons called lateral markers indicate the port and starboard sides of the waterway to be followed. U. S markers follow the buoy age system known as Red Right Returning. When returning from sea or traveling upstream, the green markers are to port (on your left) and the red markers are to the starboard side (on your right). When traveling downstream or out to sea the marker color would be reversed.

Before operating your vessel, learn to identify the various navigational aids such as lateral aids, mid-channel markers, information and regulatory markers.

NOTICE

SKIPPERS MUST NOT RELY ON BUOYS ALONE TO MARK THEIR POSITION. SEVERE WEATHER CONDITIONS AND WAVE ACTION CAN ALTER A BUOYS POSITION. NEVER TIE UP TO A BUOY. IT IS ILLEGAL AND DANGEROUS.

Lateral Aids

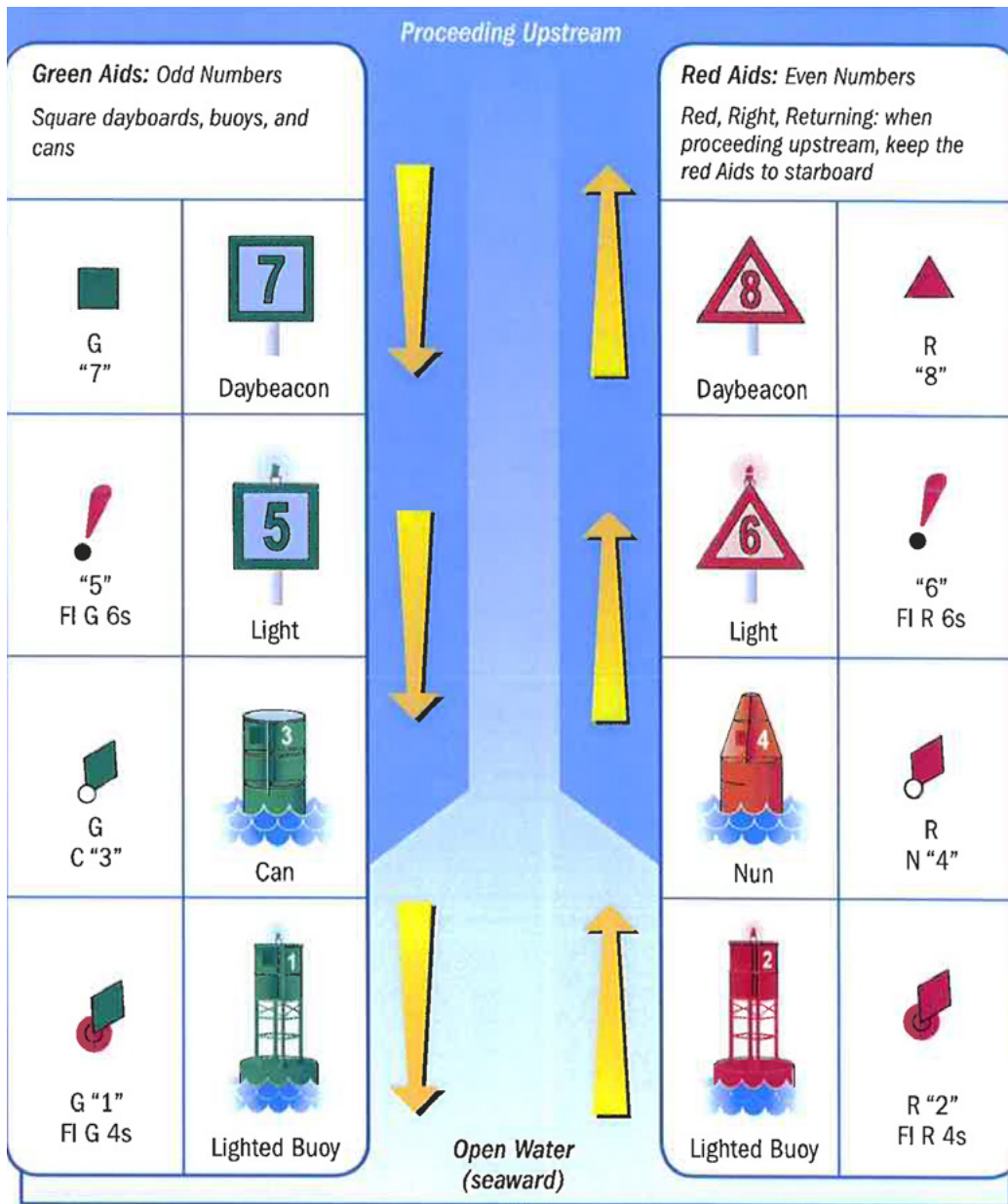

Characteristics

- Beacons may have green odd numbers.
- Buoys may have white odd numbers.
- If lit, the light will be green and is likely to flash in one of the following patterns:













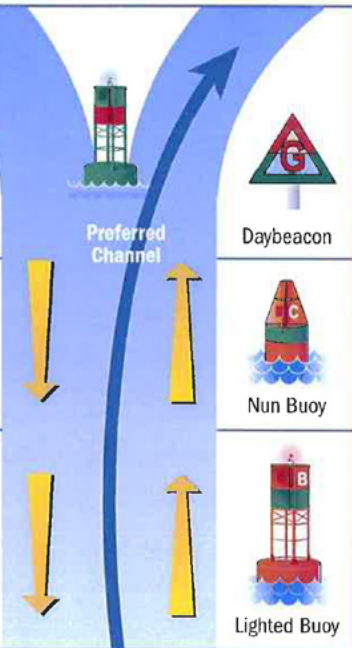

Flashing (2)	
Flashing	
Occulting	
Quick Flashing	
Isophase	

Characteristics

- Beacons may have red even numbers.
- Buoys may have white even numbers.
- If lit, the light will be red and is likely to flash in one of the following patterns:

Flashing (2)	
Flashing	
Occulting	
Quick Flashing	
Isophase	

Channel Markers

 GR "U"	 Daybeacon		 Daybeacon	 RG "G"
 GR C "S"	 Can Buoy		 Nun Buoy	 RG N "C"
 GR "A" Fl (2+1) G 6s	 Lighted Buoy		 Lighted Buoy	 RG "B" Fl (2+1) R 6s
<p>Characteristics</p> <ul style="list-style-type: none"> Green on top. Have a letter designation. Buoys will feature a white letter. If lit:  COMPOSITE GROUP FLASHING (2-1) 			<p>Characteristics</p> <ul style="list-style-type: none"> Red on top. Have a letter designation. Buoys will feature a white letter. If lit:  COMPOSITE GROUP FLASHING (2-1) 	

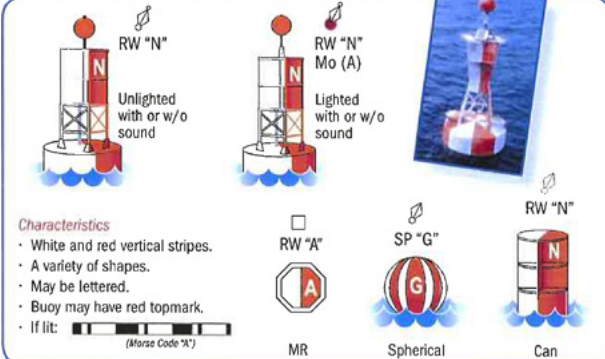













Characteristics

- White and red vertical stripes.
- A variety of shapes.
- May be lettered.
- Buoy may have red topmark.
- If lit:  (Morse Code 'N')

MR Spherical Can

Regulatory Markers

Symbol	Meaning	Examples
	Danger A diamond shape alerts boaters to hazards	 
	Restricted Operations Marks with a circle indicate areas with regulated operations	 
	Exclusion A diamond shape with a cross means boats are prohibited from the area	 
	Information Marks with a square provide helpful information such as directions, distances, and locations	 

Night Running

Boats operating between sunset and sunrise (hours vary by state), or in conditions of reduced visibility, must use navigation lights. Night time operation, especially during bad weather and fog, can be dangerous. All Rules of the Road apply at night, but it is best to slow down and stay clear of all boats regardless of who has the right-of-way.

To see more easily at night, avoid bright lights when possible. Also, it is helpful to have a passenger (appoint as lookout) keep watch for other boats, water hazards and navigational aids.

To determine the size, speed and direction of other vessels at night, you should use the running lights. A green light indicates starboard side, and a red light indicates port side. Generally, if you see a green light, you have the right-of-way. If you see a red light, give way to the other vessel.

Bridge Clearance

Be aware that your vessel requires a specified bridge clearance height. This height is a measured

estimate from the waterline to the top of the highest equipment height. The estimated height can change because of variances in the loaded condition of the vessel and equipment variances. Consult the bridge clearance specifications located in Chapter 12 (Technical Information section). Some bridges are tendered. Know and use the proper bridge signals when approaching these bridges (see bridge signals in this chapter). You can also monitor and communicate on channel 13 of a VHF radio for bridge information in most domestic locals. Other bridges are marked with a clearance measurement and you are on your own. It is recommended that you have a look out posted for additional visual assistance when entering a bridge zone.

After determining your vessel will clear the bridge proceed with caution at a safe idle speed. Keep your eye on vessel traffic at all times in order to react quickly. Keep both hands on the helm since you may need to change course because of current and wind conditions. Resume a safe speed once clear of the bridge structure and acknowledgment of clear visibility. Just use common sense around any type of bridge structure!

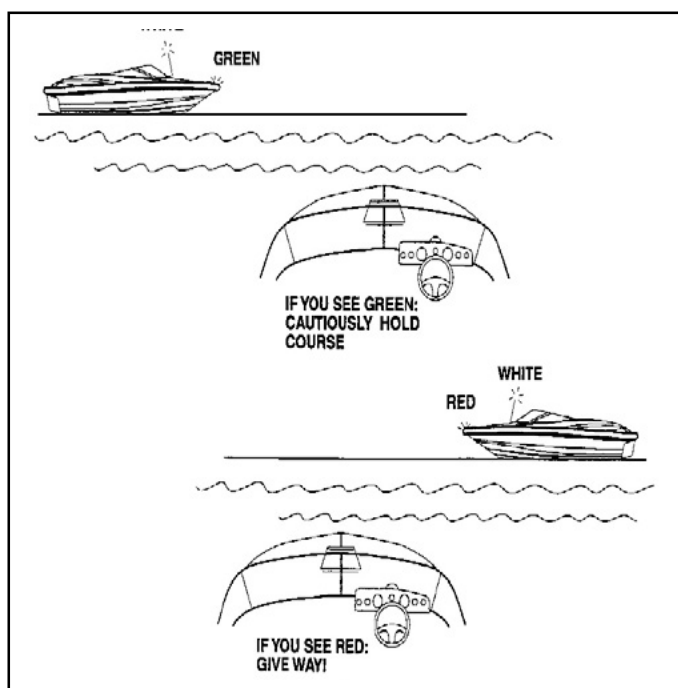

Bridge Lighting:

Bridge lighting is maintained by the Department of Homeland Security. On the following pages are 2 typical examples of night-time bridge lighting. As the skipper approaches bascule and fixed bridges light position (arc of visibility) and color will indicate the safe channel through the bridge. Notice green denotes the “safe” entry location on single-span bridges and green or white on multiple-span bridges designates the main channel. In addition, green denotes the “up” position for single and double lift bridges.

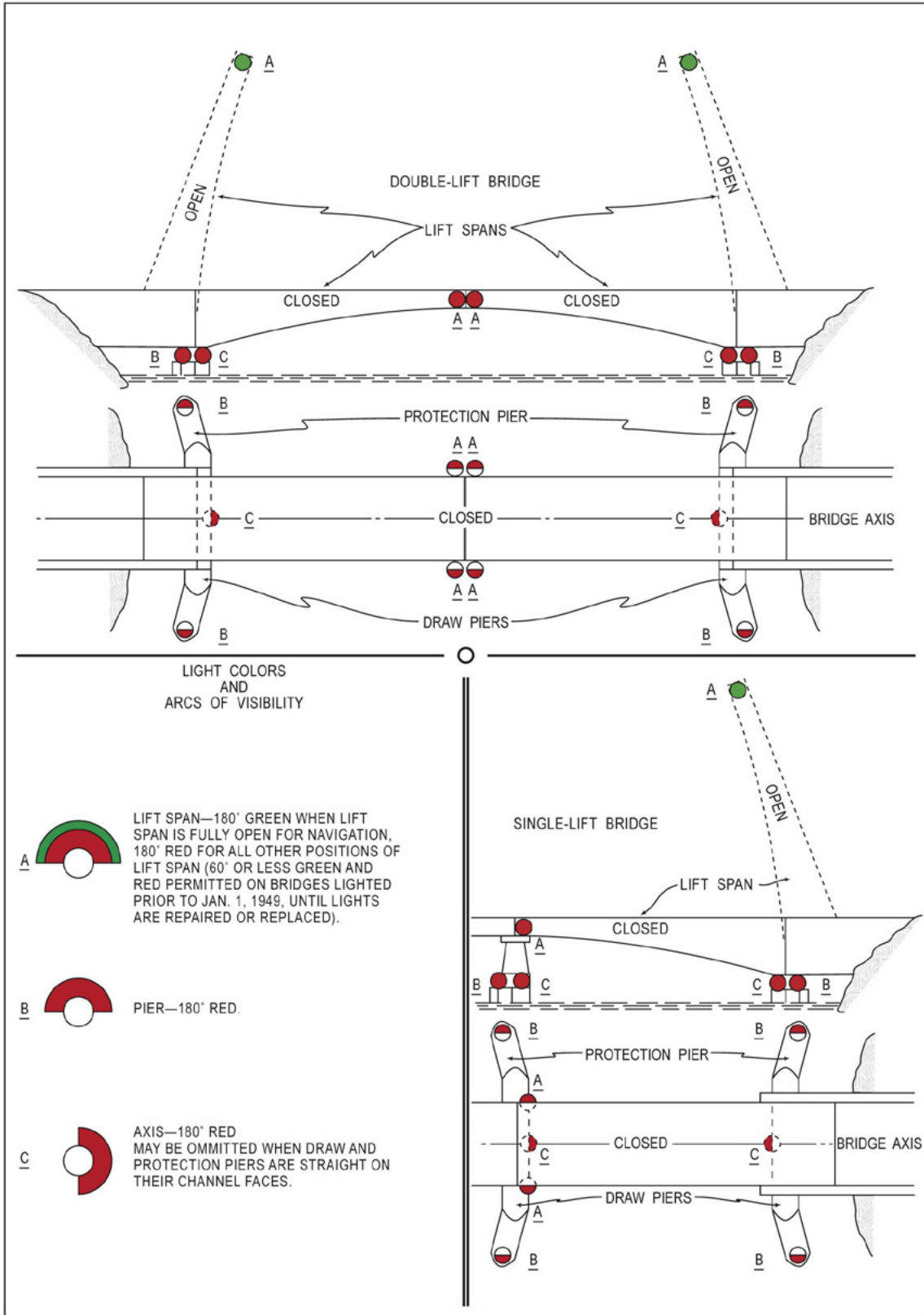

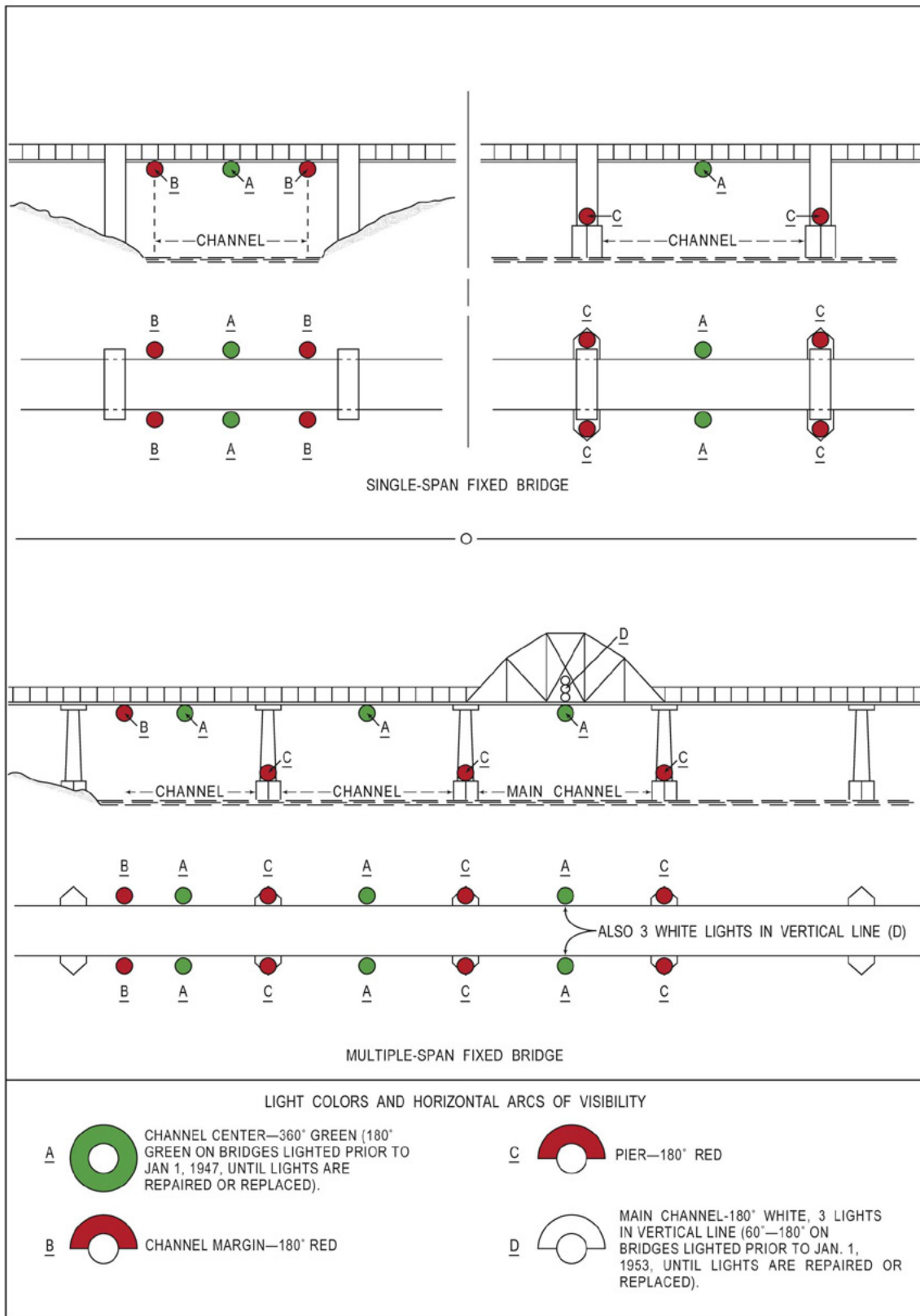

Chapter 4

Systems

Overview

In this chapter Regal on board systems are introduced. Information includes several main systems including fire protection, fuel, electrical, water, waste, electronics, entertainment and trim tabs. In short, this chapter is the “meat and potato” section for systems.

A system description, location of components, and operational information is found in this section. Enhanced vendor component details and troubleshooting can be found in the owner’s information packet along with the troubleshooting chapter of this manual.

Be sure to read and follow any danger, warning, or caution labels in reference to boat systems or individual equipment components.

Note that your Regal boat may not contain all of the equipment or systems shown. Regal has the right to modify, update or delete equipment and/or systems at anytime. Refer to the vendor documentation located in the owner’s information packet for more detailed information of individual system components and/or the chapter on equipment operation.

 **WARNING**

PREVENT INJURY OR DEATH!
READ AND UNDERSTAND THE
PROPULSION AND GENERATOR OWNER'S
MANUAL BEFORE ATTEMPTING
TO OPERATE THE VESSEL.

Fire Protection

Automatic Fire Extinguishing System



Vessels with generators use both a powered ventilation (blower) system and a fire extinguishing system in the sump capable of automatic and manual activation. The dash monitor utilizes an instrument display unit light that provides the operator with a system

status of a charged or uncharged condition by an audible alarm and icons. With the ignition switch on and a no light condition it indicates that the system has been discharged.



If the fire extinguishing system should discharge the ignition system will be instantaneously interrupted and the engines will shut down. See the automatic fire

extinguisher manual in the owner’s packet for additional details.



If a fire has started in the engine compartment the system will automatically discharge or the operator can manually discharge the extinguisher. Find the system manual cable assembly located in the cockpit. To use the manual remote remove the safety pin from the

“Fire T Handle” and pull firmly on the “Fire” handle which will activate the fire extinguisher unit in the engine compartment. A loud “rushing air” sound may be heard. Complete discharge will take several seconds. Keep the compartment closed for a period of time sufficient to permit the agent to soak all areas of the protected space. This allows hot metals and fuel time to cool. Refer to the automatic fire extinguisher owner's manual for additional information.

Note: The boat operator needs to educate the crew on fire protection and more specifically the automatic fire extinguishing system in the event that he becomes incapacitated. It is a good idea to practice by having a mock fire drill.

Portable Fire Extinguishers

Clean agent extinguishers are primarily for Class B and C fires (gasoline is a flammable liquid under the Class B group). The extinguisher should be of the 5 lb. capacity and 2 are recommended based on the maximum capacity of the fuel tank onboard and the boat length. These extinguishers may be available from your dealer, marine speciality stores, or on the internet. It is recommended to have extra portable fire extinguishers to backup the automatic fire extinguisher system since a fire could take place in an area outside of the sump/machinery space.

As noted above a clean agent type of liquefied gas used today is FE-241. This gas is colorless and odorless, heavier than air and sinks to the lower parts of the sump to extinguish fires. Since the year 2000 ingredients have changed to a more environmental friendly formula (Chlorotetrafluoroethane or FE-241). FE-241 is used in portable-hand units.

The canister needs to be weighed once a year. Also, the canister is engraved with a date which is part of the canister life cycle. Refer to the information regarding fire prevention in this manual and on the internet. Normally the clean agent fire extinguishers cost more than powdered or CO2 extinguishers.

Electrical System

Overview

In this section, basic DC (direct current) and AC (alternating current) electrical systems are introduced. Select electrical components are reviewed along with their location and function within the electrical system.

For more complicated issues outside the scope of this manual contact your closest Regal dealer. They have undergone extensive training on the Regal boat systems.

Be sure to read and follow any danger, warning, caution, or notice labels in reference to the vessel's electrical system or individual equipment components. Also, refer to the owner's information packet for further product information or the internet.

DC Current

Your Regal boat uses 12 volt DC electricity otherwise known as direct current. It is called DC because it flows only one way in a circuit. Specifically to name a few, helm gauges, batteries, battery cables, engine electrical components, engine wiring harnesses, dash switches, selected lighting, shower sump, bilge pumps, and vacuum toilets are all components using a 12 volt DC system.

In the domestic DC system the red wire is designated as the "hot" or conductor wire and the black wire is referred to as the ground wire. At times other current carrying wires are color coded such as blue to identify their use as a low voltage conductor. This is especially helpful in troubleshooting and adding additional equipment. Be sure to review the wiring schematics in the drawing section of the technical chapter.



WARNING

PREVENT SEVERE INJURY OR DEATH!
DISCONNECT
ALL ELECTRICAL POWER SOURCES
BEFORE ATTEMPTING
TO REPAIR OR REPLACE
ANY ELECTRICAL COMPONENT.



CAUTION

AVOID CHARGING SYSTEM DAMAGE!
DO NOT TURN ENGINE AUTOMATIC
BATTERY SWITCHES TO THE "OFF"
POSITION WITH THE ENGINES RUNNING.
THIS INCLUDES THE PORT, STARBOARD &
CENTER (OPTION) LABELED SWITCHES.

TYPICAL DC (12 VOLT) WIRING COLOR CODE & SIZES		
BLACK	16,14,12,10,8,6,4,2,2/0,40	GROUNDS
BLACK/WHITE	16	HALON INDICATOR
BLACK/YELLOW	10,16	GRD. DIESEL TRANSFER PUMP, MERC DIESEL STOP CIRCUIT
BLACK/WHITE	10	HALON MAIN GRD. FEED
BROWN/BLACK	10	MACERATOR, SUN ROOF
BROWN	10	SUN ROOF
BROWN	14	AFT BILGE PUMP-MANUAL
BROWN/WHITE	14	AFT BILGE PUMP-AUTO
BROWN/RED	14	FWD. BILGE PUMP-AUTO
BROWN/BLUE	14	FWD. BILGE PUMP-MANUAL
BROWN/PINK	16	CO DETECTOR
BROWN/BLACK	16	SHOWER SUMP PUMP
YELLOW	12,10	BLOWER
YELLOW/WHITE	16	HEAD VENT FAN MOTOR
YELLOW/BLACK	16	STEREO MEMORY
YELLOW/RED	14	ENGINE START CIRCUIT

Note: The list above applies to a number of vessels. Vessel components/wiring specifications may vary depending on the model.

TYPICAL DC (12 VOLT) WIRING COLOR CODE & SIZES (CONTINUED)		
ORANGE	10,12	VACUUM TOILET, REFRIGERATOR, HATCH RAM
ORANGE	16	WIPER RUN
ORANGE/WHITE	16	WIPER PARK
ORANGE/BLACK	10,12,16	HORN, HATCH RAM
BLUE	14	INTERIOR LIGHTS, SWITCHED CIRCUIT
BLUE/RED	14	INTERIOR LIGHTS, CONSTANT HOT CIRCUIT
BLUE/BLACK	16	COCKPIT SOFT LIGHTS
BLUE/GREEN	16	INTERIOR SOFT LIGHTS
BLUE	10	CABIN LIGHT MAIN CIRCUIT FEED
GRAY	14	NAVIGATION LIGHTS, RUN- NING, BOW, TRANSOM LIGHTS
GRAY/BLACK	14	NAVIGATION LIGHTS, AFT AN- CHOR, MASTHEAD
GRAY/WHITE	14	NAVIGATION LIGHTS, MAST- HEAD, FWD. RUNNING LIGHTS
RED	16	POSITIVE FEED- ELECTRON- ICS, GAS VAPOR DETECTOR, BREAKER TO DASH SWITCH FEEDS

Note: The list above applies to a number of vessels. Vessel components/wiring may vary depending on the model.

TYPICAL DC (12 VOLT) WIRING COLOR CODE & SIZES (CONTINUED)		
RED/WHITE	16	WINDLASS CONTROL-DOWN
RED/BLACK	16	WINDLASS CONTROL-UP
RED/WHITE	14	BATTERY PARALLEL-LOAD
RED	14	POSITIVE FEED-ELECTRONICS
RED	12	POSITIVE FEED-ELECTRONICS
RED	10	POSITIVE FEED-AUTO PILOT
RED/VIOLET	10	FUEL TANK TRANSFER PUMP AMPLIFIER POWER
RED	8	POSITIVE FEED- MAIN ALTERNATOR CHARGE
RED	6	POSITIVE FEED- MAIN ALTERNATOR CHARGE
RED	4	POSITIVE FEED-MAIN
RED	2	POSITIVE FEED- MAIN STARTER, BATTERY, GENERATOR
RED	2/0	POSITIVE FEED- MAIN, START- ER, BATTERY
PURPLE	16	STBD. IGNITION, HOUR METER- WINDSHIELD VENT
PURPLE/WHITE	16	PORT IGNITION, HOUR METER, WINDSHIELD VENT
PINK	16	STBD. FUEL TANK SENDER
PINK/BLACK	16	PORT FUEL TANK SENDER
TAN/BLUE	16	ENGINE ALARM CIRCUIT
GREEN	16	TANK LEVEL MONITOR, SPOT- LIGHT
GREEN	10	SPOTLIGHT
GREEN	8	BONDING

Note: The list above applies to a number of vessels. Vessel components/wiring may vary depending on the model.

Batteries

All vessel DC equipment and specifications are subject to change at any time as part of Regal's commitment to product improvement. Equipment shown here and information is up to date per the manual printing date. Read the following pages and view the accompanying photos relating to the onboard battery system components as the battery system is the "meat and potatoes" of the direct current (DC) system.

Note that we will review various battery system components onboard the vessel in multiple locations although many of the items are located in the sump.

Battery Terminology Descriptions

Group- Batteries are divided into groups which identify the height, length, and width of the battery. This is useful information should a replacement battery become necessary. Note that the 38 SAV currently uses 31-A batteries for engine cranking needs and 8-D batteries as house and house accessory deep cycle needs.

Cold Cranking Amps (CCA)- This rating measures the cranking power of a full charged marine battery having the ability to start at 32 degrees F. Basically, the higher the rating the greater starting power of the battery.

Reserve Capacity (RC)- As usage on the boat increases so does the need for more reserve capacity. The reserve capacity represents the length of time in minutes a new fully charged battery can maintain the vessel's electrical needs without the engine running or in the event a stator failure.

BATTERY SPECIFICATIONS			
Battery Type	Group	CCA @32 Degrees F.	Reserve Capacity
Engine Cranking	31 A	1260	195 min.

BATTERY SPECIFICATIONS			
Battery Type	Group	CCA @32 Degrees F.	Reserve Capacity
House/ House Acc.	8 D	1400	430 min.

Battery System Introduction

Note that periodic maintenance of batteries is needed especially in warmer climates. Contact your closest Regal dealer or marine professional for additional information on battery system care. Direct current is stored in the ship's batteries and produced through the engine stators while the engines are running or by the battery charger at dockside. The outboard stators charge the batteries by sending current through the main distribution panel relays, battery switches and harnesses to the appropriate battery. Normal DC voltage is between 12 and 15 volts. Lower or higher readings could indicate a charging malfunction or a weak battery. There is a special output wire for output stator voltage that travels from the alternator to each of the battery switches (orange #4 wire).

Note that current specifications for alternator output at WOT (wide open throttle) is 50-70 amps per each 350 Yamaha outboard and 90 amps per each 425 hp Yamaha outboard. Information and models subject to change.

House Battery Notes

There are two house batteries located in the sump on your vessel. One is called out as the “house” battery and the other is known as the “accessory house” battery. They are both group 8-D type batteries. They weigh approximately 128 pounds each. Both feature long reserve capacities.



TYPICAL GROUP 8 D BATTERY

Many of the DC lighter amperage draw component circuits use the “house” battery sometimes called the house main. Examples are bilge pumps, macerator, fresh water pump, and lighting circuits.

Several of the DC heavier amperage draw component circuits use the “house accessory” battery. These include as installed stabilizer (Seakeeper), bow thruster, windlass, and generator. All 8 D batteries in your vessel are of the flooded lead-acid variety. Refer to the previous pages for house battery locations.

Engine Battery Notes

As part of the standard triple engine propulsion package each engine features a designated group A 31 starting battery. These batteries each weigh approximately 45 pounds and offer plenty of cold cranking amps for engine starting. All 31 D batteries in your vessel are of the flooded lead-acid type.



TYPICAL GROUP 31 A ENGINE BATTERY

Refer to the previous pages for engine battery locations.

Typical Battery Locations

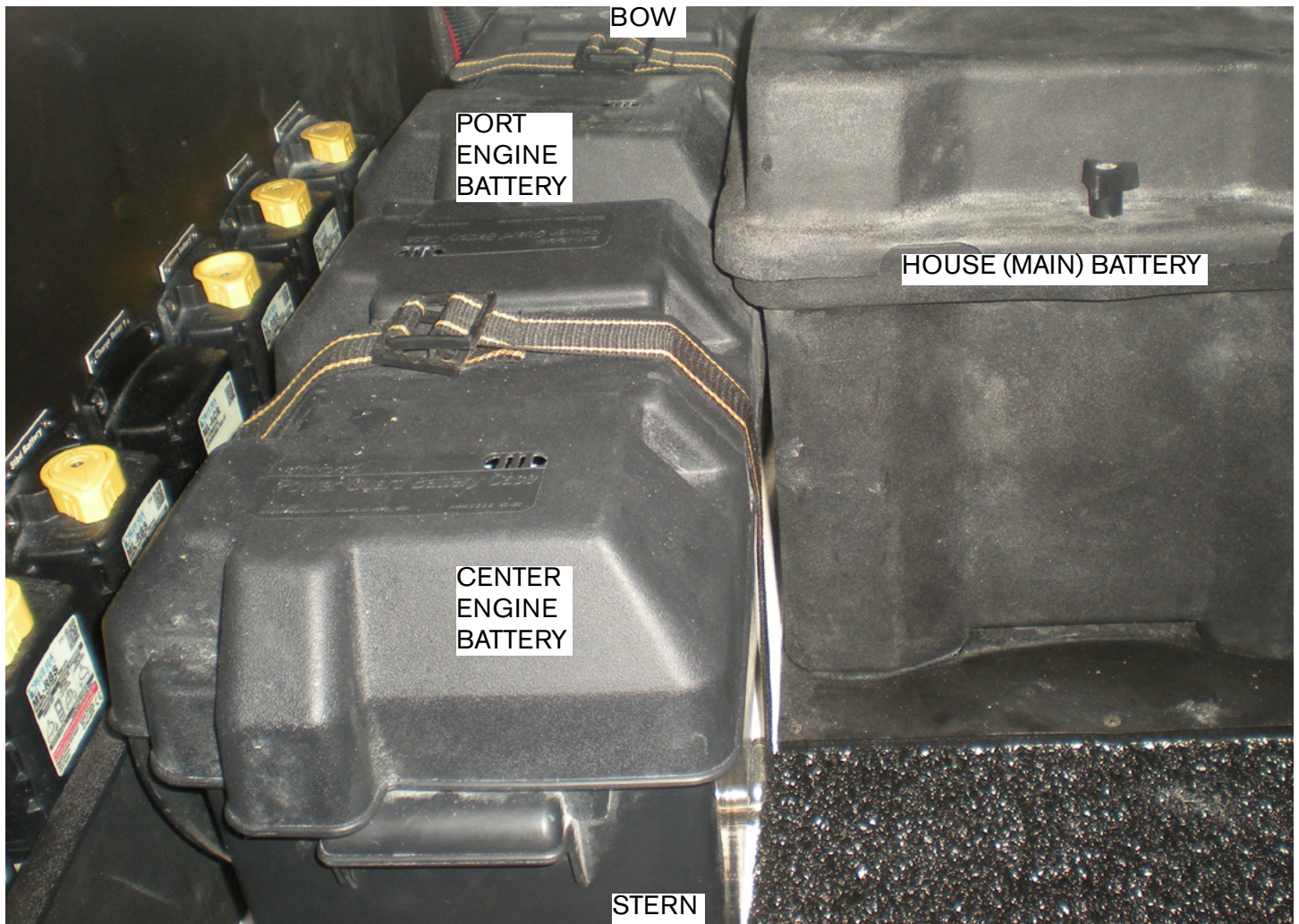

PORT AFT DECK



STBD AFT DECK



Battery Problems/Solutions



1. Weak battery- This battery problem can be caused by low electrolyte cell levels.

Warm, bilge compartment temperatures will deteriorate a battery's life quicker by evaporating the water from the electrolyte, thus corroding and weakening the positive grids inside the battery.

With the house battery low electrolyte levels can be monitored by periodic inspection and filling as needed with distilled water. Boaters in higher climate areas with longer stretches of hot weather will need to check their batteries more often.

The "maintenance free" engine cranking batteries require no water. They do feature a different chemistry that does consume less water. Inside the cells as gases are released condensation is formed which aids in maintaining the cell electrolyte level. These batteries incorporate a deeper layer of electrolyte over the plates, but eventually it can run dry. On the 31 series engine cranking batteries keep all terminals clean, connections tight and your electrical system in top shape to extend battery life.

2. Dead Battery- Either the battery will not accept a charge, hold a charge or the charging system is not supplying a charging current through the battery charging system and/or engine stators.

The battery charger output can be checked by monitoring the lights on the charger front face.

To begin with check the battery post connections for tightness and corrosion.

With the engines running the displayed voltage of the port or starboard engine battery and house battery should be between 12.5 up to 14.6 volts.

If less than 12 volts check for voltage across the battery terminals.

If less than 12 volts on the house battery use a hydrometer to locate faulty cells.

On maintenance free batteries they can be removed from the vessel if necessary and trickle charged. If readings after charging are still low replace the battery.

Main Ship's DC Panel



The ship's main DC panel is located at the port side cabinet as you reach the bottom of the cabin entrance steps. Open the cabinet door to access.

Following is a brief description of breaker switches and their function along with other components displayed at the panel.

12 Volt DC- Displays available DC voltage

Cabin Lts- This breaker switch controls the DC light fixtures in the cabin such as reading, overhead, and courtesy LED types which are controlled by switches at various wall plate locations.

Head- This breaker switch controls the vacuum style toilet function.

Bunk Actuator- This breaker switch controls the actuator which permits the seat in the forward cabin to lower into a sleeping berth.

Blowers- This double pole switch controls the generator powered ventilation system. **Read and understand the warning information next to the switch.**

Entertainment- This breaker switch controls the power to the cabin and cockpit televisions.

Main Ship's DC Panel (Con't)



USB/DC Recep- This breaker switch controls the various USB ports found through-out the vessel. Also, the switch controls any 12 volt plugs which are available to plug in accessories such as portable spotlights, etc.

Head Vent- This breaker switch controls the powered ventilation fan in the head. The switch is mounted on the head wall.

Key switch- This key when in the “on” position permits the overboard discharge pump to operate as the macerator switch is activated at the main battery activation panel under the cockpit cushion.

Generator Start/Stop Switches- These switches control and starting and shutdown generator functions. See the generator section for further information.

DC Hatch/Cockpit TV Actuator Modules

In the cockpit at the waste receptacle are 2 black boxes. Inside the boxes are actuator relay modules. One controls the cockpit television actuator and the other controls the Lazarette hatch actuator. To gain complete access the starboard side refrigerator (as you face the bow) would need to be removed.

A possible problem could be the hatch will not go up or down or just one direction could be affected. Refer to the wiring diagram below for further information.

Push Button Actuator Relay Modules

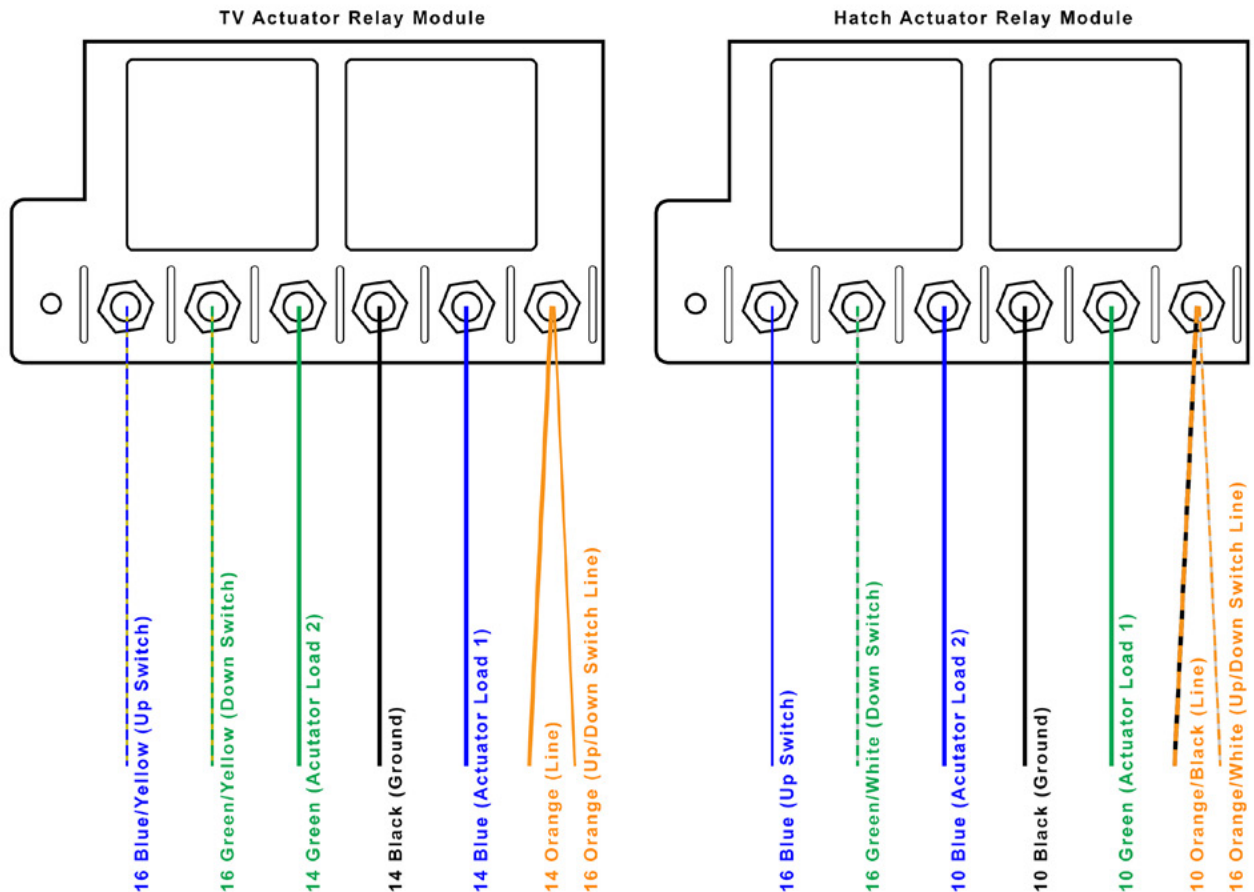

Direct Current (DC) Distribution Panel

**Note that earlier production panels read "BATTERY MANAGEMENT PANEL". The ACC breakers protected the bow thruster option and the mid bilge pump even though the breakers were not labeled as read on the newer panel.

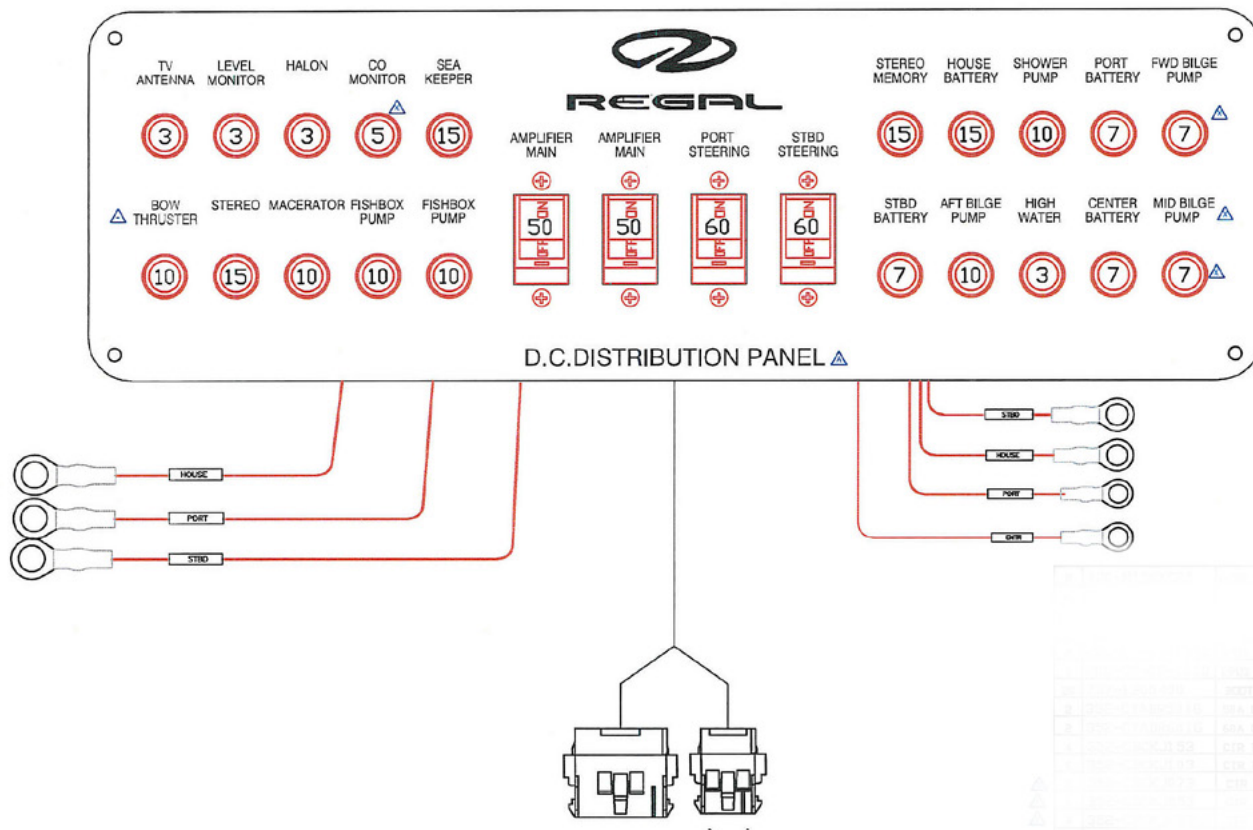

Introduction

The DC distribution panel provides over current breaker protection for numerous standard and if installed optional equipment components along with protecting the house and engine battery automatic remote battery switches located in the bilge (sump).

The distribution panel uses thermal circuit protection which utilizes a bimetallic strip electrically in series with the circuit. These types of breakers can be reset after tripping and therefore have a significant advantage over fuses. Always find the cause of a tripped thermal breaker before resetting it.

Contact your closest Regal dealer to order breaker replacements as they will match the original equipment.

DC Distribution Panel-Resetting Breakers



1. It is possible that one of the DC distribution system amplifier or steering pump breakers may trip from long-term arcing and heat.

To trip and/or reset this style of breaker do the following:

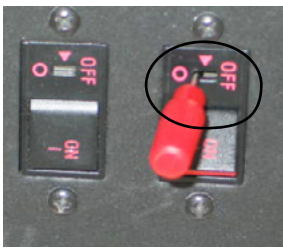

A. Take a small slotted insulated screwdriver from your on-board tool kit and insert it in the breaker slot until it trips. You will hear a snapping type noise. See the illustration.

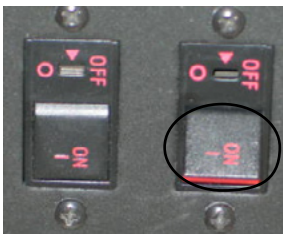

B. Notice that the breaker has pushed outward from its original flush position indicating the breaker has been tripped. See the illustration.

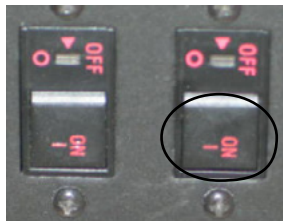

C. To reset the breaker use your finger to press the breaker down until it locks in the “on” position. You may hear a slight noise.

This is normal. The icon display should be lighted after this procedure. See the illustration.

2. Breaker will not reset- Replace the breaker. Contact the nearest Regal yacht dealer for replacement parts.

3. Breaker continues to “trip”. Check the affected equipment to determine if it is responsible for the excessive draw to trip the breaker. If the equipment is determined to be within specifications check for a “short” in the wiring circuit. Also, the breaker may be faulty. Contact the closest authorized Regal dealer for service and parts.

Note: It is possible under certain circumstances that a breaker may preform a “soft” trip on a circuit. The breaker may not appear to be in the tripped position but at this point current to dedicated components in this particular case is interrupted.

It is recommended to turn any equipment on the circuit to the “off” position until the breaker is reactivated. In this situation insert the insulated screwdriver blade into the breaker slot until it fully trips the breaker. Then reset the breaker by pushing the breaker down until it clicks into place. At this point energize the circuit by activating components or equipment.

Battery Activation Panel

Note for battery activation panel wiring information refer to the system break-out drawings in the technical chapter of this manual.

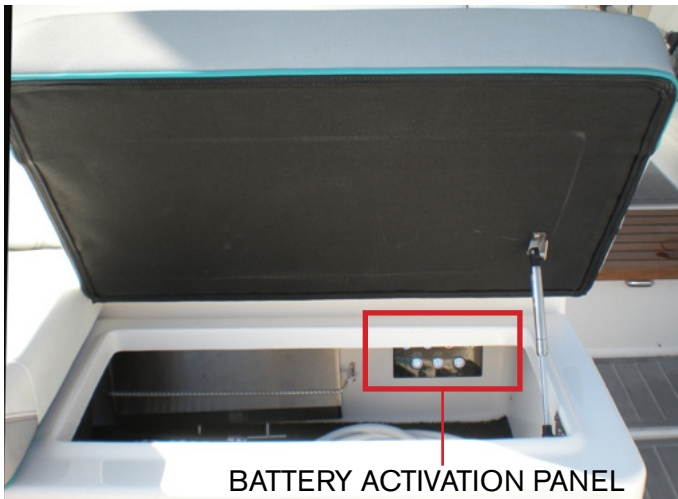

Introduction

The battery activation panel is a major game player in reference to the vessel's battery system. The panel display shown above is located under the cockpit starboard cushion.

The battery activation panel controls 3 engine batteries and 2 house batteries. Each engine is provided with an individual switch to control the battery and starting functions for that engine.

The port, center and starboard battery switches when activated permit individual engines to be started. The battery activation panel footprint also includes house battery switches.

In addition, the battery activation panel permits battery parallel functions when an engine or house battery is in a low charge condition. Read the information on the following pages regarding the battery engine and house parallel features.

Battery Management System (Outboard- Later)

The battery management panel shown on page 72 of this manual is used on outboard vessels and features a set of remote battery switches which are connected through the battery activation panel.

When activated by the battery activation switches individual engine cranking and house battery functions are energized. Also, battery parallel circuits are connected as the parallel buttons are activated on the battery activation panel. Note that both ACR's (automatic charging relays) and a parallel switch are key players in the battery charging process as shown on page 72.

Note that the system includes Aux. charge wiring from each outboard. Also, there may be steering system breakers fed by the Aux. charge system.

Located on the bottom of remote battery switches are switch link plates which connect battery switches and assist in charging current bleeding through to all connected battery circuits.

The remote battery switch circuits are charged by the outboard engine stator system when the engines are running and by the battery charger when a shore power cord is connected from the vessel shore power inlet to a marina shore power supply center.

Remember that a remote automatic battery switch must be in the remote position to be operational. See page 74.

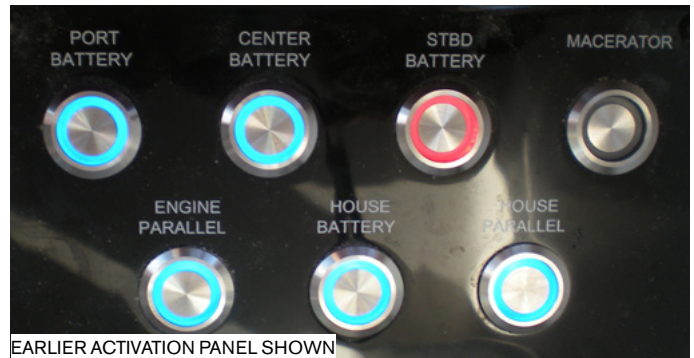

Battery Activation Panel (Earlier)- Operation

Earlier Panels- Each button displays a continuous blue ring *when power is available to that button function.*

When a button is depressed to activate a switch the blue lit ring changes to a red ring indicating that current is flowing through the entire circuit. *For example, when the stbd. battery button is depressed the lit blue ring changes to red indicating the starboard engine battery circuit is engaged and it is ready for starting the starboard engine. In the course of depressing the button a magnetic induction process at the starboard automatic battery switch (located in the sump on the battery management panel) occurs due to current in the circuit pulling a magnetic latch down and holding the automatic battery switch in a closed position. This permits starboard engine battery availability to start starboard engine.*

Battery Activation Panel (Later)- Operation

Later Panels- Each button displays a continuous ring color *only when the button is depressed.*

When a battery switch is depressed the switch will emit a blue color.

When a parallel switch is depressed the switch will emit a red color.

Macerator- This switch as shown on the previous page in a normal “off” position displays no colored ring. When the overboard discharge pump (macerator) key switch is turned to the “on” position at the ship’s main DC panel the battery activation panel button labeled macerator will show the blue lighted ring **only on earlier battery activation panels.**

Remember that pumping waste overboard requires a 2 step process. After the key switch is turned to the “on” position the macerator button at the battery activation panel can be depressed to start the waste pumping process.

While the macerator pump is cycling the macerator panel button will display red.

Battery Activation Panel- Button Functions

Port Battery- This switch when depressed completes a circuit to the port engine battery through the port automatic battery switch on the battery management panel. This permits port engine starting operations.

Center Battery- This switch when depressed completes a circuit to the center engine battery through the center automatic battery switch on the battery management panel. This permits center engine starting operations.

Stbd. Battery- This switch when depressed completes a circuit to the starboard engine battery through the starboard automatic battery switch. This permits starboard engine starting operations.
Note that the engine battery type is a group A-31.

House Battery- This switch when depressed completes a circuit to the house batteries which includes both the house main and house accessory units. Current runs through both the house and house accessory automatic battery switches.
Note that both house batteries are group 8-D.

Read and understand the following label regarding using the battery parallel functions on the battery activation panel.

<p style="text-align: center;">NOTICE</p> <p style="text-align: center;">THE BATTERY PARALLEL FEATURES ON THIS VESSEL ARE INTENDED FOR EMERGENCY INTERMITTENT USE ONLY! WHEN A PARALLEL FEATURE IS REQUIRED IT MAY INDICATE A SERVICE BATTERY IS NEAR THE END OF ITS USEFUL SERVICE LIFE.</p>
--

Engine Parallel- This switch when depressed will parallel (combine) the port engine battery to the starboard engine battery. In addition, it will parallel the center engine battery to the house main battery for emergency intermittent use.

House Parallel- This switch when depressed will parallel (combine) the “house main” battery to the starboard engine battery. In addition, it will parallel the “house accessory battery” to the port engine battery for emergency intermittent use.

Automatic Remote Battery Switch System-Overview

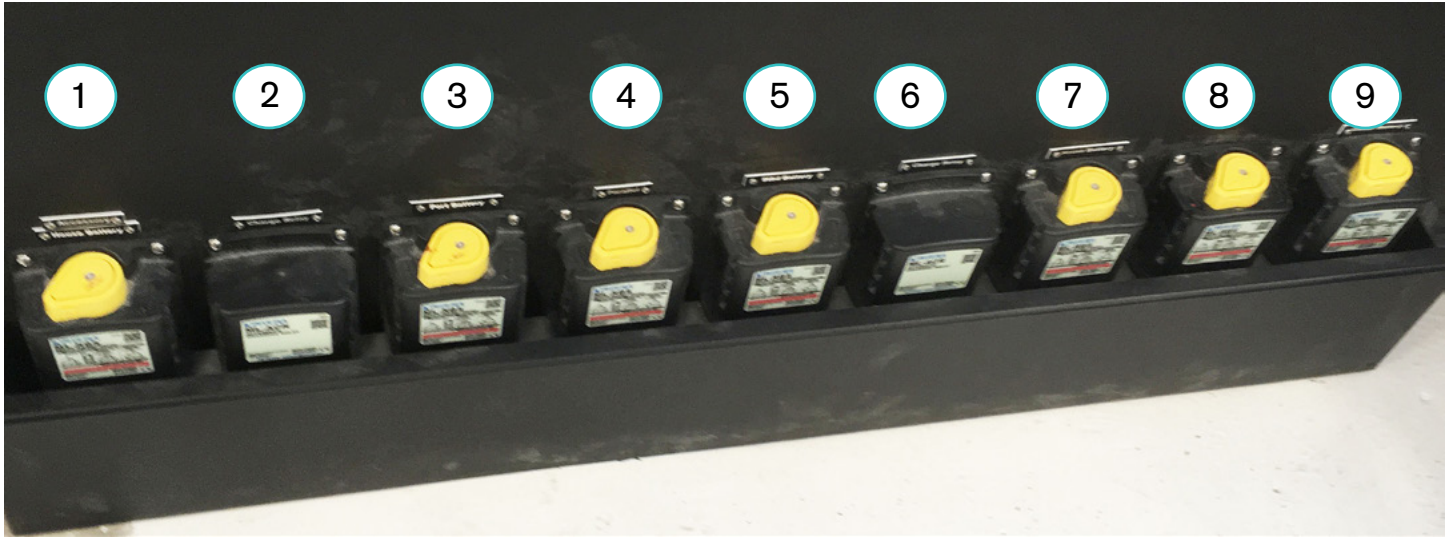

Introduction

The battery management panel (shown above) features a set of remote battery switches which are connected through the battery activation panel. When activated by the battery activation switches individual engine cranking and house battery functions are energized. Also, battery parallel circuits are connected when the parallel buttons are activated on the battery activation panel.

The remote battery switch circuits are charged by the outboard charging system when the engines are running and by the battery charger when shore power is utilized.

Note that a 50 amp battery charger is standard and when the stabilizer option is installed a 100 amp charger is standard.

There are 3 battery charger wires that carry current as needed to the house accessory, house main and engine cranking battery circuits.

Overcurrent protection for battery charger wires for the house accessory and house main circuitry is provided by a 60 amp cube fuse located on the remote battery switch stud. When the optional

stabilizer is installed a 125 amp cube fuse replaces the 60 amp standard cube fuse.

Note that when #8 and #9 center engine option is used (triple outboards) a 60 amp cube fuse protects the optional center battery circuitry using a 50 amp standard charger.

When the stabilizer option is installed a 100 amp battery charger replaces the 60 amp cube fuse with a 30 amp cube fuse as the charger leg for this circuit supports approximately 20 amps.

Located on the bottom of remote battery switches are switch link plates which connect battery switches and assist in charging current bleeding through to all connected battery circuits.

Note for battery system wiring information refer to the system break-out drawings and the battery management system overview drawing in the technical chapter of this manual.

Remote Battery Switch Description

1. House Accessory Battery- This remote battery switch is connected to the largest DC amperage components that may be installed including the bow thruster, windlass, generator and stabilizer (Seakeeper). One of the battery charger legs is connected to this battery switch to provide charging current to the house accessory battery when on shore power. With the engine running a dedicated stator charging output #6 wire is connected to an Aux. charge breaker and then supplies current to the house accessory battery.

2. Charging Relay- This is known as an ACR switch which translates to Automatic Charging Relay. This device permits charging current to be shared between the house accessory and port engine batteries. It also allows paralleling of battery banks for emergency starting through the battery activation panel. It isolates batteries when discharging and starting the port engine.

3. Port Battery- This remote battery switch is connected to the port engine starting battery circuit.

4. Parallel- This remote battery switch serves to combine specific system battery functions. By depressing the engine parallel button at the battery activation panel it parallels the port to the starboard engine battery. In addition, it will parallel the center engine battery to the house main battery for emergency intermittent use.

5. Stbd Battery- This remote battery switch is connected to the starboard engine starting battery circuit.

6. Charging Relay- This is known as an ACR switch which translates to Automatic Charging Relay. This device permits charging current to be shared between the house main and starboard engine batteries. It also allows paralleling of battery banks for emergency starting through the battery activation panel. It isolates batteries when discharging and starting the port engine.

7. House Main Battery- This remote battery switch is connected to the house main battery. One of the battery charger legs is connected to this battery switch to provide charging current to the house main battery when on shore power. With the engine running a dedicated stator charging output #6 wire is connected to an Aux. charge breaker and then supplies current to main house battery. There is also a take-off lug for the house battery to dash breaker.

8. Parallel- This remote battery switch serves to combine specific system battery functions. By depressing the house parallel button at the battery activation panel it parallels the house main battery to the starboard engine battery. In addition, it will parallel the house accessory battery to the port engine battery for emergency intermittent use.

9. Center Battery- This remote battery switch is connected to the center engine starting battery. One of the battery charger legs is connected to this battery switch to provide charging current to the center engine battery when on shore power. With the engine running a dedicated stator charging output #6 wire is connected to an Aux. charge breaker and center engine battery.

Remote Battery Switch Operation

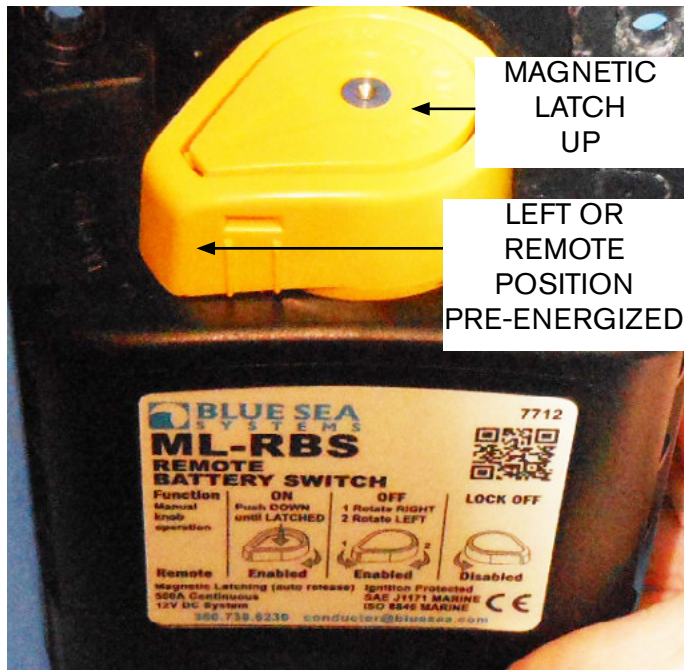

1. Normal operation of the remote battery switch is completely to the left in the auto or “remote” position. Notice latch position is up (manually disengaged). To energize the house circuit press the appropriate switch at the battery activation panel. Once the switch is energized the magnetic latch will be pulled down in the energized position.

2. If the remote battery system fails for some reason the skipper can override the remote battery switch manually through the magnetic latch which is located on top of the switch. Just turn the switch to the left and push the magnetic latch down until it engages.

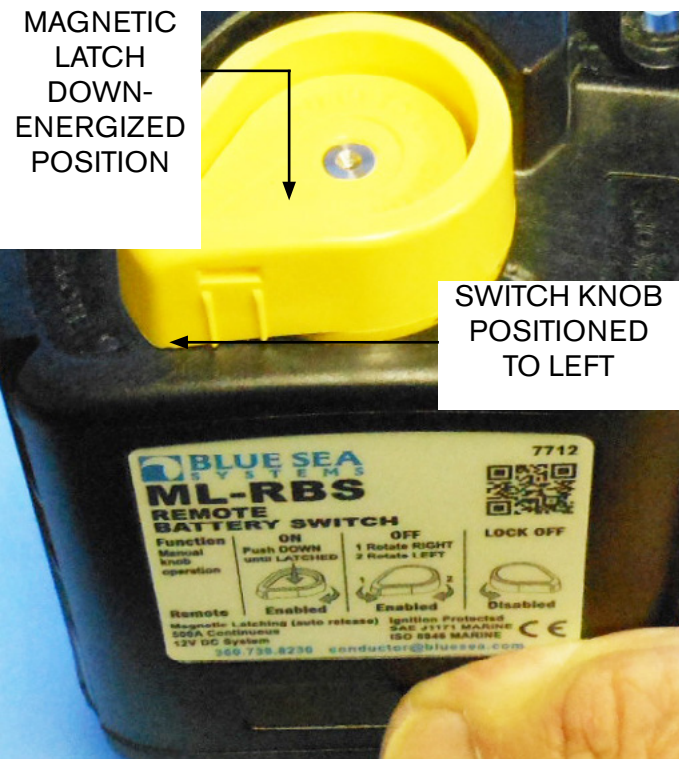

3. In the event of servicing the house battery components simply turn the remote battery switch to the right (Lock or Off Position). Pass a tie wrap through hole to secure the remote battery switch knob until servicing is complete.

Remote Battery Switches, Charging Functions & Battery Management

If a remote battery switch is positioned as shown below (straight out, OFF position) that particular battery or connected battery bank will be inoperative. This positioning could effect both starting and house circuitry. After sump maintenance or electrical repairs always check the battery switches to ensure switches are in “on” remote position.



2. When operating the optional Seakeeper (stabilizer) make sure to run generator to charge the house accessory battery.

3. Periodically check all battery hardware for tightness and ensure battery electrolyte is up to required cell levels. Use only distilled water for filling lead acid types of batteries. Wear proper eye wear and gloves when servicing battery systems. Read the maintenance chapter for more information.

4. Check all battery bank hardware for tightness and corrosion. Maintain as needed.

5. Always turn off the battery switches at the battery activation panel before leaving the vessel.

6. For safety sake, charge all batteries out of the vessel to eliminate possible hydrogen gas build-up in the sump and sparks from battery charger/leads.

Battery Board Circuit Breaker System

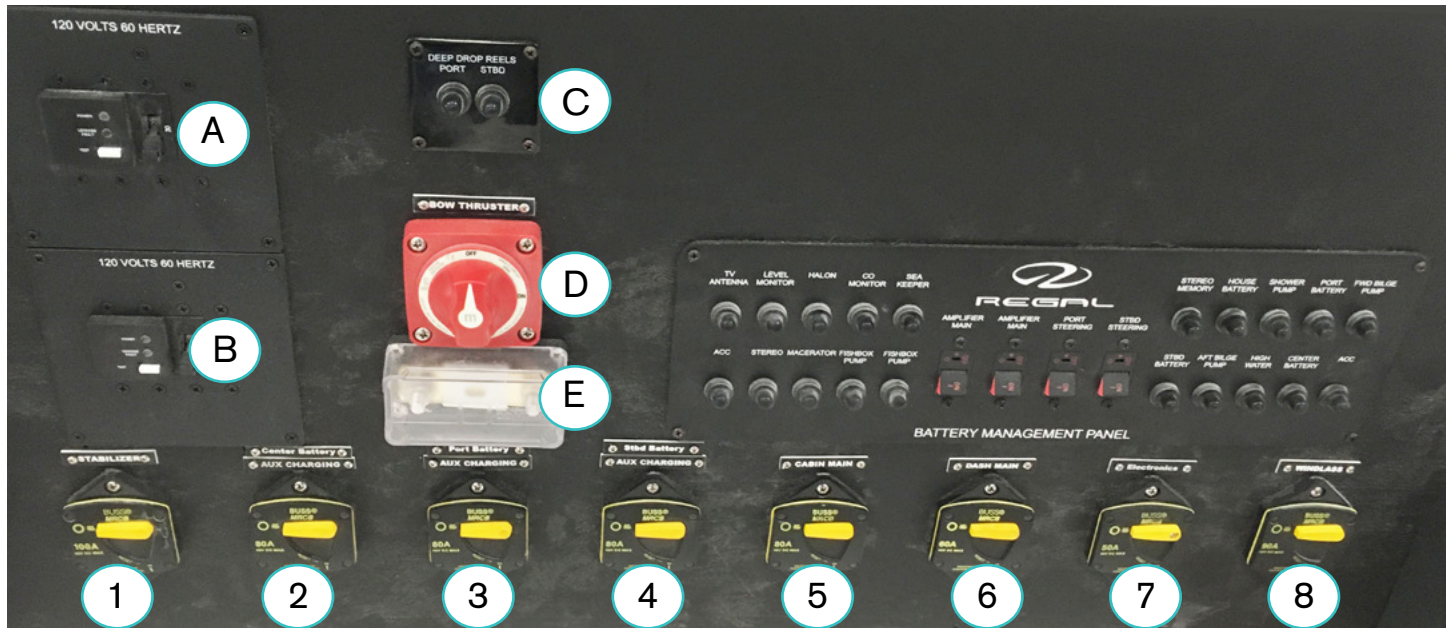

1. **Stabilizer-** This 100 amp breaker provides over current protection for the optional Seakeeper circuit.

2-4. **Auxiliary Charge-** These three 80 amp breakers provide over current protection for each outboard stator output charging circuit. This is a #6 wire traveling from the outboard to the breaker back. One breaker is utilized for each engine charging battery.

5. **Cabin Main-** This 60 amp breaker protects the cabin main DC circuit to DC cabin panel.

6. **Dash Main-** This 80 amp breaker protects the main DC circuit to the helm.

7. **Electronics-** This 50 amp breaker protects the electronic component circuitry including plotters, video camera, VHF radio, radar, Garmin remote, ACC 1 and NMEA backbone as installed.

8. **Windlass-** This 90 amp breaker protects the windlass circuitry installed at the foredeck.

Note if one of the above mentioned breakers “trips” find the cause of the problem before resetting the breaker. Push the handle down to reset.

Other Breakers, Fuses & Switches

A-B. **ELCI Breakers-** This stands for Equipment Leakage Circuit Interrupter. This breaker and system will be reviewed in the AC electrical section.

C. **Deep Drop Reel Breaker (Option)-** This breaker protects the port and starboard deep drop reel system primarily used to catch fish while vessel is trolling in deep water.

D. **Bow Thruster (Option)-** This switch activates or deactivates the bow thruster system used to maneuver the vessel.

E. **Bow Thruster Fuse-** 200 amp DC fuse.

Battery Board Stud Blocks & Harness Plugs

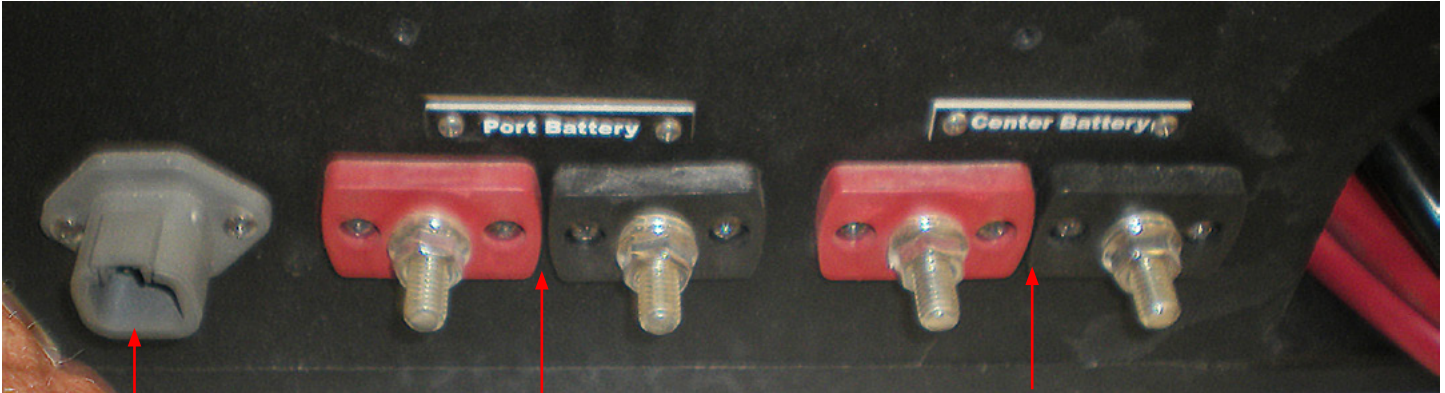

DEEP DROP REEL
HARNESS PLUG
(OPTIONAL)

PORT BATTERY POSITIVE/
NEGATIVE CABLES FROM
PORT O/B

CENTER BATTERY POSITIVE/
NEGATIVE CABLES FROM
CENTER O/B

Battery Cable Studs- Located on the aft end of the battery board are battery cable studs. Red is + or positive and black is - negative for DC power. Always observe correct polarity when handling any battery cables. These cables originate from the port and center outboard engines. The studs provide attachment points for battery system cables.

The starboard outboard positive and negative battery cables are attached to a separate stud block located at the port transom. The orange #6 wire feeds from the outboard motor to the stud block and terminates at the 80 amp Aux. charge breaker

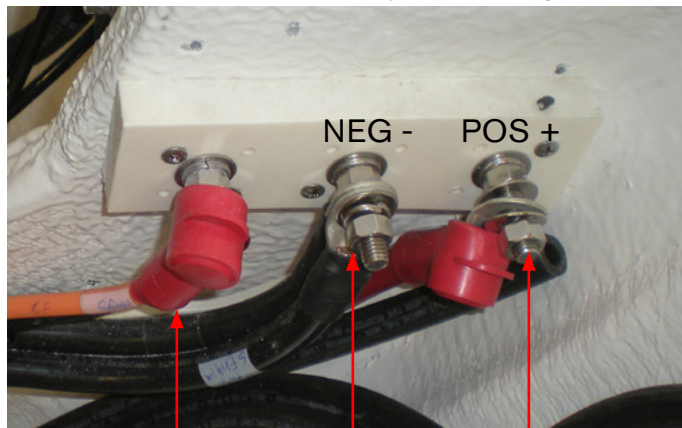

AUX. CHARGING	NEG -	POS +
WIRE FROM	STBD	STBD
STBD OUTBOARD	BATTERY	BATTERY
	CABLE	CABLE

Deep Drop Reel Harness Plug- This is an attachment point for the optional deep drop reel system. If installed the harness terminates on the port and starboard deck.

Other Harness Plugs & Attachment Studs- Located on the forward end of the battery board are the following:

1. Deck harness feed
2. Sump to DC distribution panel feed
3. Deck harness feed
4. Stabilizer (Seakeeper option) DC cable feed.

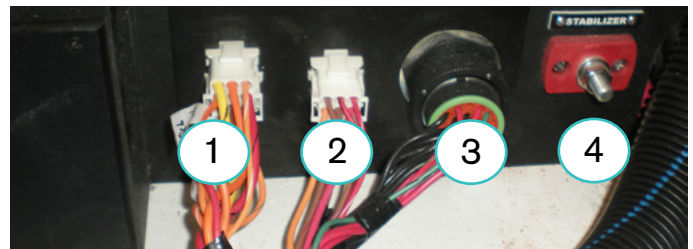

Typical Battery Charger Overview

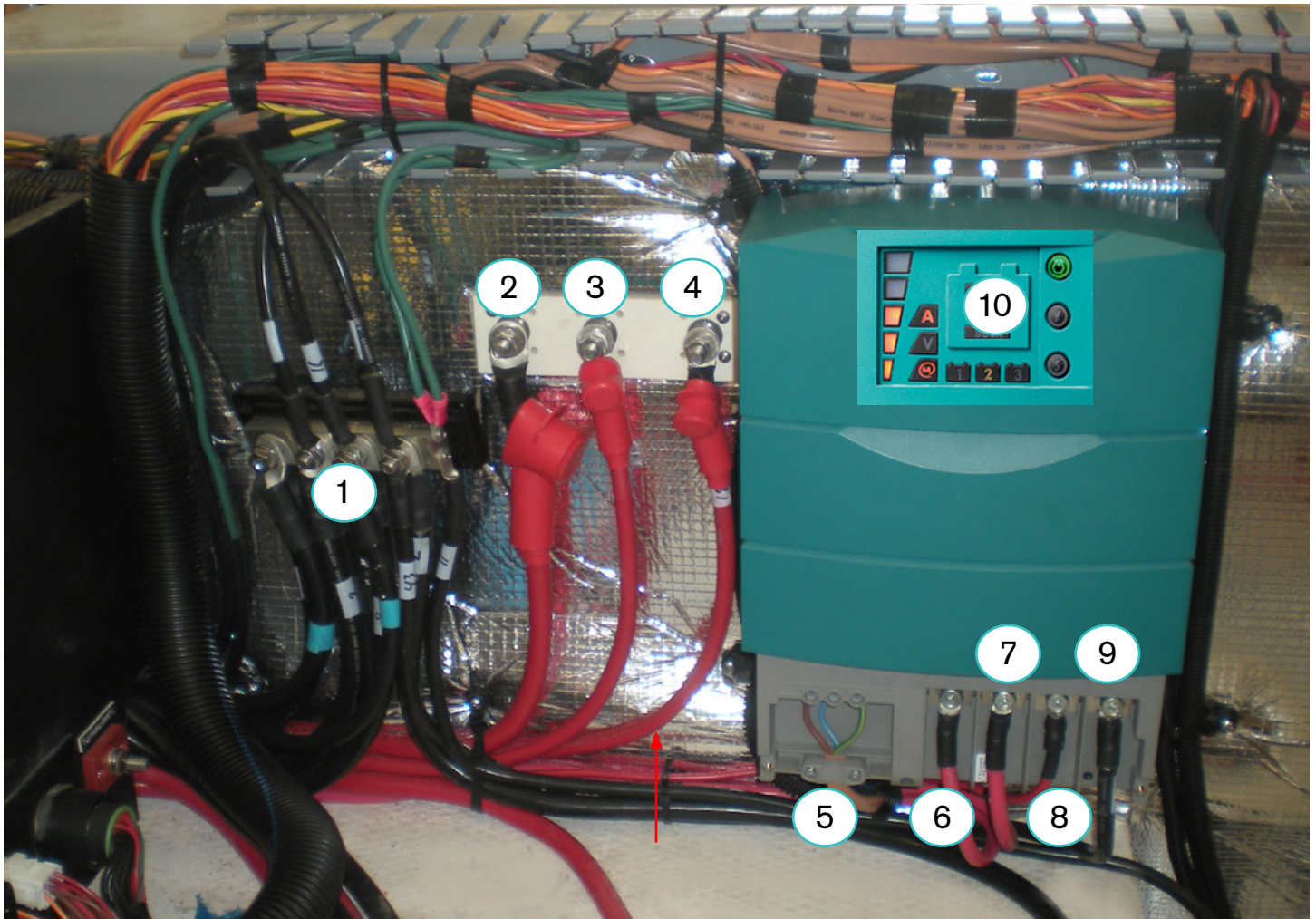

The standard 50 amp battery charger shown above with surrounding features:

1. This is a DC ground block for negative wires and cables. Periodically check tightness of fasteners.
2. Windlass main positive feed cable to bow.
3. Main helm dash DC feed cable.
4. Main electronics DC feed to helm (dash).
5. AC wiring connections-

Note to periodically check tightness of all fasteners.

6. Charger output wire to house main battery.
7. Charger DC output wire to house accessory battery.
8. Charger DC output wire to center engine battery.
9. Charger DC ground wire.
10. LED battery charger display panel.

Note: For more detailed information see the battery charger manual on-line or in the information packet.

Typical Battery Charger

The standard battery charger features 50 amp output and universal voltage for house and engine starting battery circuits. When the stabilizer option is installed a 100 amp battery charger is standard. The charger operates between 95 and 277 volts. This is helpful on docks that carry lower voltage. The new electronic battery chargers are “smart”. They will charge the batteries in 3 stages; bulk, absorption, and float formats. The charger is designed to get the maximum life out of your batteries, using micro computer controlled charging.

It is recommended to keep the battery charger “on” at all times when AC power is available for maximum battery life. We recommend checking the battery electrolyte level weekly especially in warm temperature conditions.

Fill batteries to specified levels using only distilled water. The charger is factory set to charge flooded lead acid batteries which are the most common type available. The charger can be reprogrammed to take gel cell or AGM batteries.

In the event the boat is switched over to different battery designs, it is important that all batteries are of the same type.

Remember, changing to a different battery type requires re-programming the charger. Do not mix different designed batteries because they need different charging rates and voltages.

During bulk charge the battery charger brings up the battery charge state quickly, as the battery nears fully charged, it switches over to absorption charge. Absorption charges at a lower rate than bulk, until the battery is just a few % away from full charge.

The battery charger display includes functional LED information for charge current, charge voltage, charge phase (bulk, absorption, float), battery content measurement and/or battery condition measurement as a % of Ah capacity.

It is recommended that an ABYC certified electrical technician perform any repairs or service. Do not attempt to open the battery charger casing.

Refer to the vendor information in the owner's information satchel for more detailed instructions.



WARNING

PREVENT INJURY, DEATH, OR
PROPERTY DAMAGE FROM HIGH VOLTAGE!
DISCONNECT THE AC POWER SUPPLY
BEFORE ATTEMPTING TO BEGIN ANY BATTERY
CHARGER SERVICE WORK.

Typical Battery Charger Display

The standard 50 amp battery charger features a multi-color LED display. Different LED colors and combinations realize different meanings. Combination of the current display (A) with the load bar shows the percentage of maximum current, of the three outputs to three different battery banks including accessory house, house main, and engine cranking banks. Combination of (V) with the load bar shows the actual charging voltage.

3.3 DISPLAY

The Chargemaster is equipped with a multicolour LED display. Different LED colours and combinations have different meanings. Combination of the current display (A)

with the load bar shows the percentage of maximum current, of the three Battery banks together.

Combination of (V) with the load bar shows the actual charging voltage.

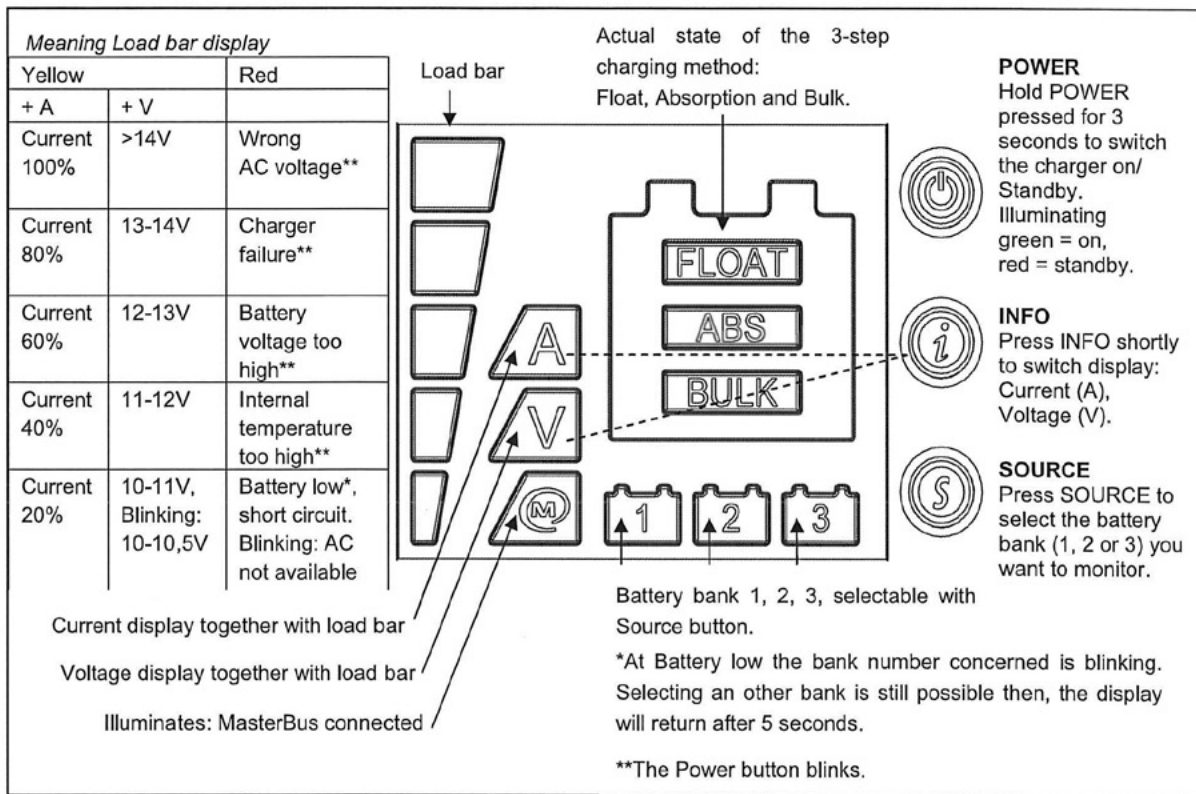
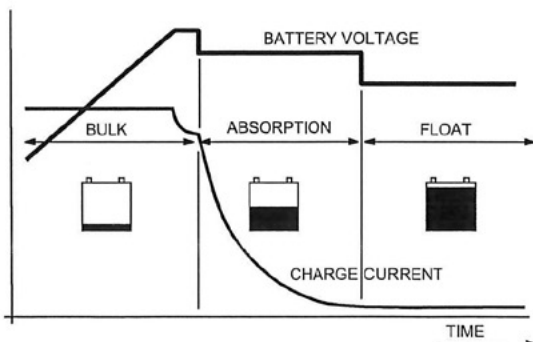

Figure 2: Display operation of the Chargemaster

3.4 THREE STEP CHARGE ALGORITHM



The first step of the three step Plus charge system is the BULK phase, in which the output current of the charger is 100%, and the greater part of the capacity of the battery is rapidly charged. The current charges the batteries and gradually the voltage rises to the absorption voltage of 14.4V (12V models) or 28.8V (24V models) at 25°C / 77°F. The duration of this phase depends on the ratio of battery to charger capacity, and also on the degree to which the batteries were discharged to begin with.

Typical Charging System- Summary Notes

Following are a few notes regarding the charging system or specific charging system components.

1. With the battery charger unplugged from shore power the battery charger is not generating any DC power. However, the battery charger is connected to the batteries through the remote battery switches and charger breakers which are located on the battery board. The charger breakers would stop any short in the wires that run directly to the battery charger. Remember that the charger is connected to the battery side of the switch and is continuously "hot".

2. There is a breaker protecting the battery charger circuit. A primary cause of the breaker to "trip" would be if the positive and negative battery cables were crossed. The above situation could easily happen if someone was trying to start a battery with "jumper cables." To a lesser degree should a wire delivering current from the battery charger chafe a fuse may "blow" and the battery charger would cease its charging operation. See your Regal dealer for ordering extra fuses for your charger.

3. If one of the engine cranking batteries is weak or "dead" and the engine will not crank first start the generator up and let it run awhile as it will send an initial charge to the weak battery.

Of course you can press the engine parallel button on the battery activation panel.

4. Always turn the battery switches on the battery activation panel to the "off" position when leaving the vessel for extended periods. Select breakers that control specific safety functions of the boat will operate as normal even with the battery switches off such as the automatic bilge pumps and stereo memory circuits.

5. When leaving the vessel after connecting your dock side power cord turn the battery charger breaker at the ship's management panel to the "on" position. This will permit the battery charging system to energize the appropriate batteries as needed.

6. Remember the appropriate engine will not crank over if the remote battery switch in the "off" or straight out position.

7. An internal battery charger fuse protects the entire circuitry from reverse connections. For example, if someone was attempting to "jump" start an engine and had the polarity reversed on the jumper cables this action may cause the internal fuse to "blow" thus making the charger inoperative.

Bottom line- always remove a battery if using a trickle charger. Do not jump start engines using booster or jumper cables attached to batteries located in the bilge since sparks could ignite from battery or gas vapors.

Typical On-Board Lighting System

The on-board lighting system features a variety of fixtures in the cabin, cockpit and deck areas. Their source of power is 12 volt direct current.

There are a variety of fixtures with most featuring LED technology (Light Emitting Diode). LED lighting works by passing electrical current through a microchip, which illuminates the tiny light sources called LED's and the result is visible light.

To prevent performance issues, the heat LED's produce is absorbed through a heat sink. LED's are more efficient, versatile and last longer. Since there is no "filament" they are cool to the touch which makes them safer for children too. LED's are available in bright white, soft white and day-light types. The amount of LED light is measured in lumens verses watts which is used to measure older incandescent type bulbs.

Bottom line with LED's on board there are no light bulbs to change!

To use the deck pop-up light simply twist the top and turn. It will emerge from its receptacle. Push down and turn to collapse.



LED READING LAMP



LED POP-UP DECK LIGHT

AC Current

Overview

Alternating current sometimes called AC current is brought on board through the use of a dock-side (shore power) cord or produced on board through the generator. Just as a residential home uses 120/240 volts to run various household appliances and equipment the same holds true on your vessel.

With AC current electrons “cycle” in one direction a short distance and reverse themselves traveling in the opposite direction. This is how AC became known as alternating current. The rate that the current reverses itself is referred to as frequency. In the United States the alternating current frequency is 60 cycles per second. Overseas a 50 cycle frequency per second is standard. Component specifications must match the country's frequency.

Basic Electric Terms

Voltage is a measurement of the electrical potential that an electrical power source contains for doing some type of work for us. Think of it as electrical pressure. An example might be your boat's battery.

Amperage is a particular amount of electricity flowing through some part of a circuit. Think of it as the rate of electrical flow through your boat's wiring.

Resistance is measured in ohms and inhibits the electrical flow through a circuit. An example would possibly be an incandescent light bulb. The resistance in the light bulb element allows it to glow and brighten the cabin along with giving off heat.

It is important that you understand and respect the alternating current system used on board. Be sure to read and follow any danger, warning, or caution labels in reference to the yacht's electrical system or individual equipment components. Most of all, use common sense!

Dockside Cord Usage

The dock side cord is the basic component used to deliver dual 30 amp service from the marina dock power box to the vessel itself. Before plugging in the dock side power cord check to see that all vessel AC breakers are off. This includes the incoming as well as both the main and equipment breakers at the AC ship's control panel. See the AC panel illustration later in this chapter.

When connecting the shore power cord be sure to twist the cord into the marina inlet plug. This motion will lock the plug in the socket.

There may be several types of inlet plugs located at the marina dock power center. Be advised that the 30 amp plug is much smaller looking and the 50 amp cord will not physically fit it.

Also, marina dock power centers normally have breakers that must be activated after installing the dock side cord. Make sure the dock side cord has enough slack to weather changing tides if applicable and at the same time does not come in contact with the water. Check with the marina dock master for more information on their shore power operation and requirements.

Dock Side Cord Usage Continued



Read and understand the shore power warning label below. As needed make tidal adjustments for shore power cords to ensure they do not dangle and are not immersed in water while being used.

WARNING

Electrical shock and fire hazard. Failure to follow these instructions may result in injury or death.

- (1) Turn off the boat's shore power connection switch before connecting or disconnecting the shore power cable.
- (2) Connect the shore power cable to the boat first.
- (3) If polarity-warning indicator is activated, immediately disconnect cable.
- (4) Disconnect shore power cable at shore outlet first.
- (5) Close shore power inlet cover tightly.

DO NOT ALTER SHORE POWER CABLE CONNECTORS

Before disconnecting the shore power cord ensure that all AC equipment breakers are off at the cabin master AC panel to prevent component failure.

When disconnecting the shore power cord first turn the breaker to the "off" position at the marina dock power center. Then remove the dock side cord from the marina outlet.



DANGER

PREVENT BODILY INJURY, DEATH OR FIRE!
NEVER USE EXTENSION CORDS
OR IMPROVISED CORDS
IN SHORE POWER/MARINA INLETS.
USE ONLY APPROVED MARINE
SHORE POWER CORDS
MATCHING THE ORIGINAL
WIRE GAUGE AND AMPERAGE.

Dock Side Cord Usage Continued

Typical 30 amp domestic shore power cords (dock side cords) contain the following wires:

- Black-ungrounded conductor containing 120 volts
- White-neutral ungrounded conductor
- Green-grounding conductor

Before plugging in the dock side power cord check to see that all vessel AC breakers are off. This includes the incoming as well as both the main and equipment breakers at the AC ship's control panel. See the AC panel illustration later in this chapter.

BOAT INLET
PLUG IN END



TYPICAL 30 AMP CORD

When connecting the shore power cord be sure to twist the cord into the boat inlet plug first. The inlet plugs are located on the port deck. Note the shore

power 1 and 2 power inlets which feed the ship's AC panel 1 & 2 main breakers. The cord installs one way only. Align the 2 pins with the 90 degree shape, (or use the imprinted arrows and detentes located on the inlet plug) insert the cord end straight into the inlet plug and twist in a clockwise direction to lock in place. Screw the threaded sealing ring into the shore power inlet until tight. This protects the inlet and cord pins from moisture and possible corrosion build-up. Repeat procedure with other 30 amp cord. When not in use close and turn the covers on the shore power inlets until tight to prevent moisture from entering the plug.



TYPICAL MARINA
SHORE POWER
STATION

Tips- Marina Shore Power Stations

As you become a more experienced boater you may engage in longer cruises with over night stays. It is most frustrating after a day of hard boating to pull into a marina and find your shore power cord does not adapt to the marina shore power station. This may be especially true stopping at older marinas built before the 1978 National Electric Code was enacted for these facilities. Therefore, it is recommended that you

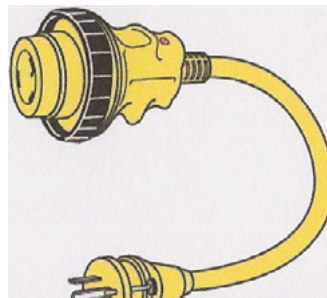

TYPICAL SHORE
POWER STRAIGHT
ADAPTER CORD

purchase several shore power adapter cords to meet various marina plug footprints. Carry a couple extra 125 volt/15 amp adapters with a female twist 3 prong plug to a straight blade male plug with a locking screw.

A point to remember is that sometimes a chart plotter will provide local cruising information including marinas and facilities they offer but normally they do not provide the power voltage available at dock side.

Shore Power Possible Problems/Solutions



1. After the dock side cord is hooked up to the marina dock power center and the AC ship's panel main breaker for shore power 1 or 2 is activated no voltage is shown on the main panel AC volt meter.

Check the breaker on the marina dock power center to ensure it is activated.

Check the ELCI breaker/voltage sensing device. The "power" icon should show green. If a leakage fault exists a "red" icon will light indicating the breaker is "tripped". If needed, use the test button to reset the breaker. Read the information in the following pages regarding ELCI system.

2. The marina dock power center lacks a 30 amp twist plug inlet.

Call the dock master or marina personnel. An adapter cord may be available from the dockage facility. **NEVER IMPROVISE ANY TYPE OF CORD OR POWER INLET CHANGES!**

Additional cord adapters can be found at retail boating outlets.



WARNING

PREVENT SEVERE INJURY OR DEATH!
ALTERNATING CURRENT (AC) CAN KILL YOU!
DISCONNECT
ALL ELECTRICAL POWER SOURCES
BEFORE ATTEMPTING TO REPAIR OR REPLACE
ANY ELECTRICAL COMPONENTS.

ELCI (Equipment Leakage Circuit Interrupter)

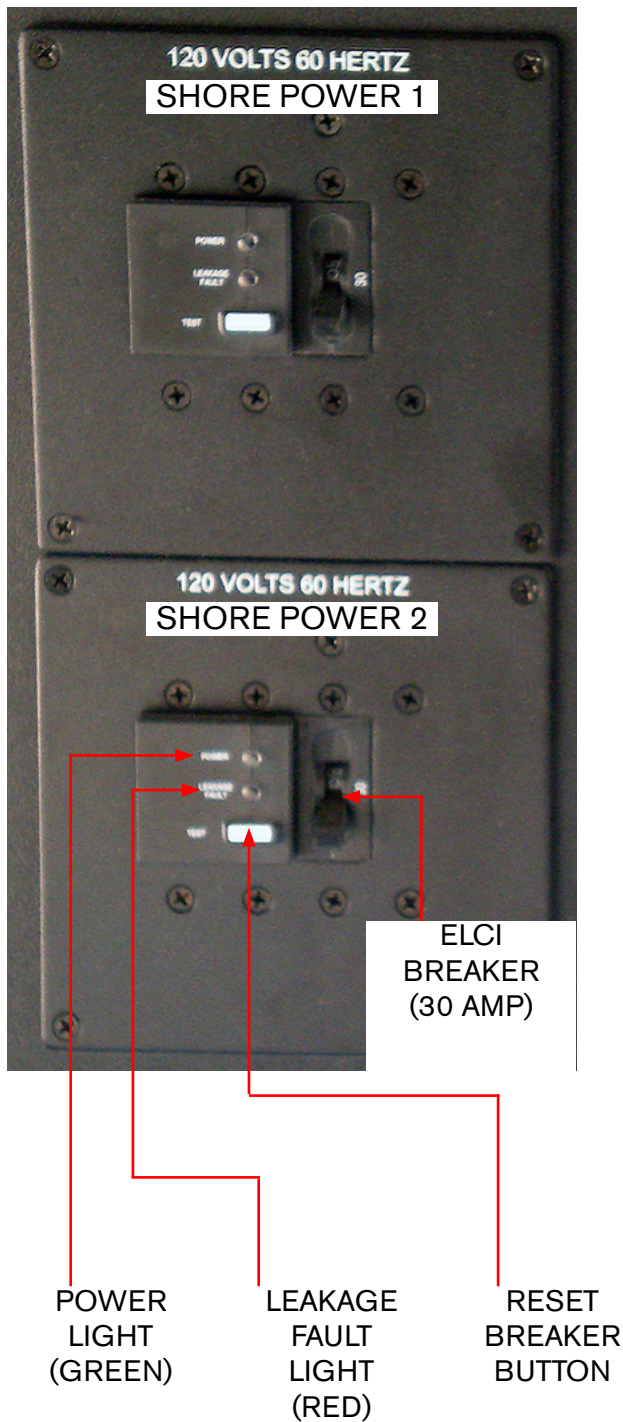

Note that shore power 1 and shore power 2 parts and operation are the same. Shore power 2 used for illustration purposes.

Once the shore power cords are attached to the marina dock side power and the vessel dock side power inlets voltage when activated travels to the ELCI actuator enclosure which is located on the battery management board in the bilge (sump). Once through the ELCI power continues to the ship's main AC control panel culminating at the shore power main and as they are activated using the auxiliary equipment breakers.

Note that both shore line breakers above are of a single throw double pole design. Both breakers above feature leakage fault technology. If the 30 amp ELCI breaker "trips" find the cause of the problem before resetting the breaker.

ELCI stands for "Equipment Leakage Circuit Interrupter". There are two potential failures in a boat's electrical system that can put people on or around a vessel at risk of lethal electrical shock. In a properly functioning marine electrical system, the same amount of AC current flows in the hot and neutral wires.

However, should electricity "leak" from this intended path in these two wires to ground, this condition is referred to as a "ground fault". An example of this is an insulation failure in the wiring of an appliance.

Furthermore, a ground fault can occur when the grounding path is broke through a loose connection or broken wire. As an example a shore power ground wire may fail due to fatigue caused by constant motion and stress. Faulty grounds can go undetected; a simple continuity test may not reveal problems.

ELCI System Continued

When these 2 conditions occur at the same time, it may produce tragic results. The combination of a “ground fault” and a faulty ground could result in the metal parts of the vessel and underwater gear to become energized. If this condition exists, besides being a hazard to personnel on board there is increased danger to swimmers near the boat. The result could be shocking people on board and swimmers could receive a paralyzing dose of electricity and drown due to loss of muscle control.

An ELCI provides protection for the entire boat and features a trip threshold which provides ground fault protection for the entire shore power system beyond the ELCI.

The ELCI protection on individual shore power lines combined with GFCI'S will reduce the risk to those on the boat, dock, and in the water surrounding the vessel.

Notice that one ELCI breaker is marked shore power 1 and the other ELCI breaker shore power 2.

Another feature of the ELCI is a “leakage fault” detector located on the side of the ELCI breaker itself. The leakage fault feature detects a change in the neutral wire current.

Should the current change more than 30 Ma or about 1/3 of an amp the unit senses the difference and will “trip” the breaker causing the leakage fault LED to illuminate red. This clearly indicates that the trip occurred as a result of leakage. Before resetting the ELCI breaker determine the cause of the leakage fault.

A proper operating alternating current system will display a green illuminated LED at the “power” marked area of the ELCI.

Periodically test the ELCI by depressing the “test” button. The breaker should “trip” indicating the system is functioning properly. Simply reset the breaker. The leakage hazard helps prevent serious equipment damage and possible fire.

After the neutral and the 2-120 volt conductors exit the ELCI they run directly to the ship's main AC control panel.

The ELCI can at times undergo a process called “nuisance tripping” which can cause a “tripped” breaker. This can be caused by overloads in the electrical draw or sometimes caused from unbalanced loads. One way to minimize the situation should it occur is to monitor closer the energized devices on the vessel which will assist in keeping the total amperage used to a minimum and the loads between panel legs more balanced.

ELCI Leakage Fault Detector LED Information

As a central segment of the ELCI system there are two LED lights with a “test” button located at the shore power inlet. With the breaker in the ‘on” position and the shore power cord hooked up these LED lights may show variations in color to provide system conditions.

They are:

1. Green LED On- Red LED Off

Line voltage is present, the breaker is closed, and the device is protecting the circuits against over current and leakage current.

2. Green LED Off, Red LED On

The device has detected leakage current and has opened the circuit breaker.

3. Green LED flashing, Red LED Off

The circuit breaker has opened due to over current or has been manually turned to the “off” position.

4. Green LED Off, Red LED Off

Line voltage is not present. Check cord connections and marina breaker for “on” position.

Note: Check circuit at least monthly by pushing in the white switch marked TEST. When depressed, the breaker should return to the reset position indicating the ELCI circuit is operating properly.

For further information on the ELCI PC-S refer to the Carling web-site. *Note that both shore power 1 and 2 use the same testing procedure.*

AC Ship's Panel (Typical)

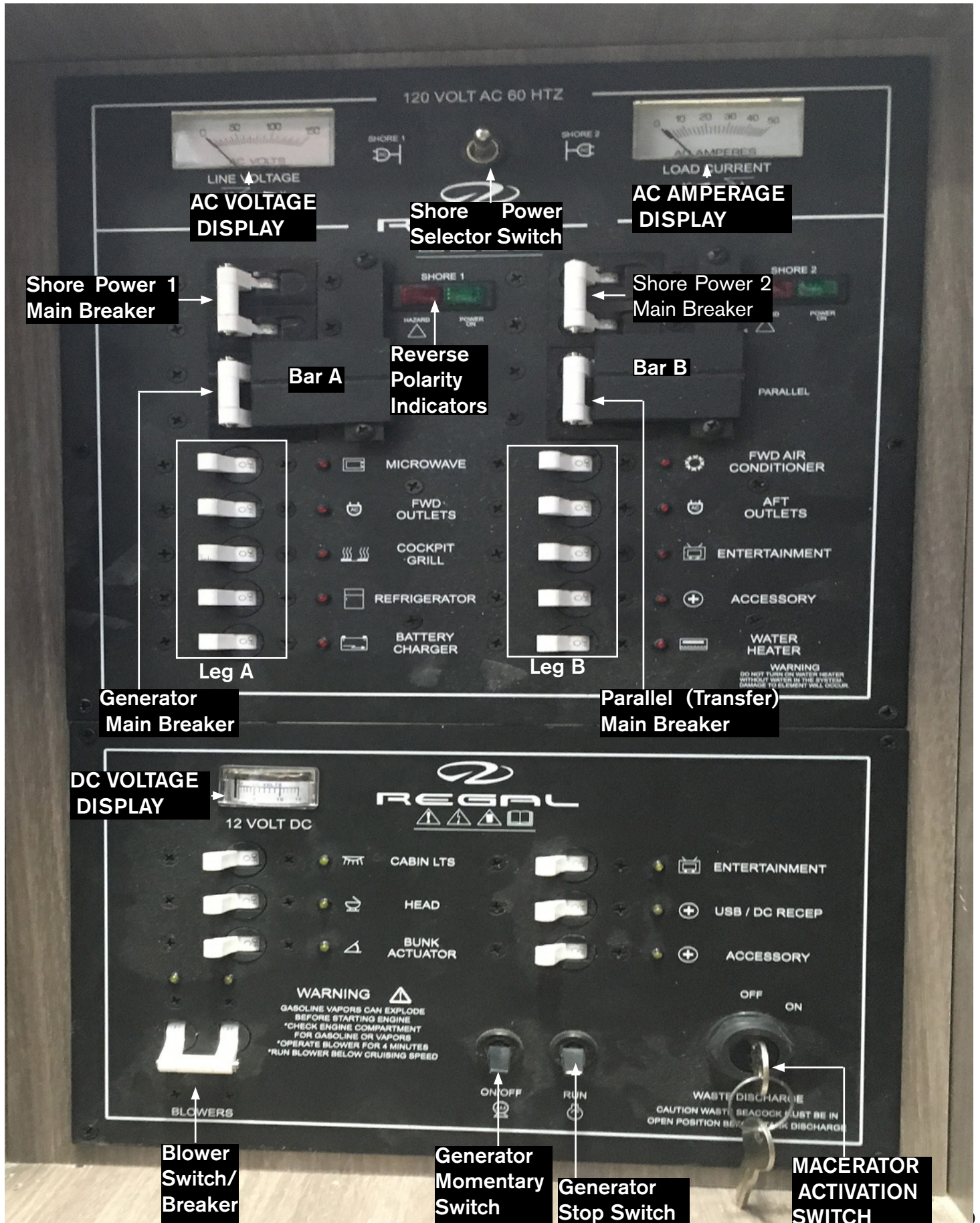

AC Ship's Panel Continued

The typical AC (alternating current) ship's panel controls all high voltage components on your vessel. This panel is 120 volts AC on twin legs. Equipment is controlled by individual breakers. Voltage is supplied by either a shore power cord (moored) or by generator (at sea) if installed. The panel features voltage and current displays.

We will discuss each major feature. Refer to the photo on the previous page to enhance each component reviewed.

Reverse Polarity Indicator

Before activating a 30 amp shore 1 or 2 breaker visually check for a green light at the reverse polarity indicator. The green light indicates there is no reverse polarity. If a red light appears on the reverse polarity indicator a hot wire and ground are probably reversed somewhere in the circuit from the dock to the main panel.

In all cases do not activate the main inlet breaker. Take immediate corrective action to find the cause of the reverse polarity situation. At this point, disconnect the shore power cord from the marina power center and call for professional assistance.

30 Amp Main AC Panel Shore power Breakers

As mentioned earlier, there are two main shore power breakers on the panel labeled shore 1 and shore 2. These single throw, double pole main breakers control power to that side of the panel and when activated deliver electricity through a system of sub breakers to the entire boat through dedicated legs of the panel. Before you energize the main breaker make sure all sub breakers are deactivated.

This prevents any excessive equipment motor draws and may eliminate any system arcing.

With the reverse polarity indicator displaying the green icon, activate shore breaker 1 by flipping the single throw arm to the on position. AC electricity now is distributed to that leg of the panel.

On the shore power 2 main breaker after bar B is moved down pull the transfer switch to the left which will allow shore 2 breaker to be activated. Now the entire panel is powered up.

At this point turn on sub breakers as needed always being conscious of the load current meter.

50 Amp AC Generator Breaker

When the vessel is under generator power at sea AC electricity is distributed through the 50 amp main generator breaker located on the AC main ship's panel beside the main breaker. See the previous illustration and the generator section for further information. Before activating the generator AC breaker it is recommended to make sure all equipment breakers are "off."

After starting the generator activate shore 1 breaker. Then push Bar A on the generator portion of the panel up and then activate the generator breaker. With the generator running activate shore 2 by flipping the shore 2 breaker to the on position. Move the bar up and flip the transfer switch to the "on" position which will direct current to shore 2 main and sub breakers.

AC Ship's Panel Continued

Line Voltage/Current Meters

After the shore power 30 amp main breaker or generator 50 amp breaker is activated line voltage will display on the the main panel.

As sub panel equipment breakers are activated the load current meter (extreme right side of panel) will show an amperage draw. Normally the amperage will ascend as more equipment breakers are activated and will descend as equipment breakers are deactivated.

Shore power 1 & 2 Switch

The 120 volt shore power 1/2 switch is located between the line voltage and load current meters. With the shore power switch in the “center” position it is off. When the shore power switch is toggled to the left the line voltage meter will display up to 120 volts available at Shore 1. As equipment breakers are activated the load current (amperage) meter will ascend and descend as equipment breakers are deactivated.

When the shore power switch is toggled to the right the line voltage meter will display up to 120 volts available at Shore 2. As equipment breakers are activated the load current (amperage) meter will ascend and descend as equipment breakers are deactivated.

The shore power 1 & 2 switch shows present usage equipment amperage can be a great tool for balancing loads between panel legs. This will help prevent circuit and panel overloads, power surging, and voltage drops.

As a general note on equipment breakers when leaving the yacht it is recommended that most breakers be turned off. It may be necessary if items are left in the refrigerator to leave the shore power cords hooked up and the battery charger on during extended periods along with the cockpit DC refrigerator since the charger keeps the batteries up.

AC Ship's Panel Continued

120 Volt Main Panel Breaker Description (Typical)

Leg A

Microwave- This 15 amp breaker controls the cabin microwave.

Fwd. Outlets- This 15 amp breaker controls the 120 volt GFCI and outlets downstream and the optional mid berth television.

Cockpit Grill- This 20 amp breaker controls the cockpit electric grill.

Refrigerator- This 15 amp breaker controls the 120 volt/12 volt cockpit refrigerator.

Battery Charger- This 20 amp breaker controls the battery charger located in the bilge. It is recommended that when leaving the boat for extended periods this breaker be left energized in order to keep the ship's batteries in a charged condition (dock side cord must be hooked up).

Leg B

Air Conditioner- This 20 amp breaker controls the cabin air conditioning unit.

Aft Outlets- This 15 amp breaker controls the 120 volt GFCI and outlets downstream and the optional mid-cabin television.

Entertainment- This 10 amp breaker controls the HDMI circuit and the cockpit television.

Accessory= This 20 amp breaker controls any aftermarket component. Always check component amperage draw before installing it.

Water Heater- This 15 amp breaker protects the hot water heater installed in the engine room.

GFCI Outlet (Ground Fault Circuit Interrupter)

Sometimes current in a circuit escapes its normal route and finds a “ground fault”. If that vehicle ends up to be your body and the current passes through your heart the results could be deadly. The outlet contacts close between 4 and 6 milliamperes.

A ground fault interrupter or GFCI senses the difference between the hot and neutral wire current before a fatal dose can be conducted and in a fraction of a second cuts the current.

The GFCI devices used in homes are normally not ignition protected and of the 15 or 20 amp variety. Your boat uses a 20 amp GFCI. By using a GFCI as the first receptacle in the circuit all the receptacles down stream on the same circuit are protected by the initial GFCI. This is accomplished by attaching the lhot wires to the line terminal of the GFCI receptacle and the out-going hot wire to the load terminal. The neutral wires also use line and load terminals on the opposite side of the GFCI receptacle.

You can identify the GFCI primary receptacle by the test and reset breaker in the center of the device. Check the GFCI protection monthly. If a problem develops with the GFCI circuitry call a marine electrician to access the situation.

The GFCI outlets are especially useful when electrical equipment is employed such as a drill or in the head with the use of personal devices such as curlers and hair dryers. Never use any electrical devices when puddling water is present to prevent a possible shock hazard.

Note: See the GFCI description on the following page.

The GFCI is programed to protect a person from line to ground shock hazards which could occur from various electrical devices operating off of the device or receptacles down stream. It does not prevent line to ground electric shock, but does cut down the exposure time to a fraction of a second before the device trips. It does not protect people against line to line or line to neutral faults. Also, it does not protect against short circuits or overloads; this is the circuit breakers job.

All GFCI's should be tested monthly to make sure they and the receptacles they protect “down-stream” are protecting against ground-faults.

GFCI Outlet (Ground Fault Circuit Interrupter)

Newer style GFIC's must automatically monitor ground fault interrupting functionality every 3 hours or less. If the device can no longer provide GFCI protection, it must deny power and provide a visual indication that it can no longer provide protection.

Your boat uses a GFCI's featuring the following:

1. Power indicator (solid green)
2. Trip indicator (solid red)
3. "End of life" indicator (flashing red)

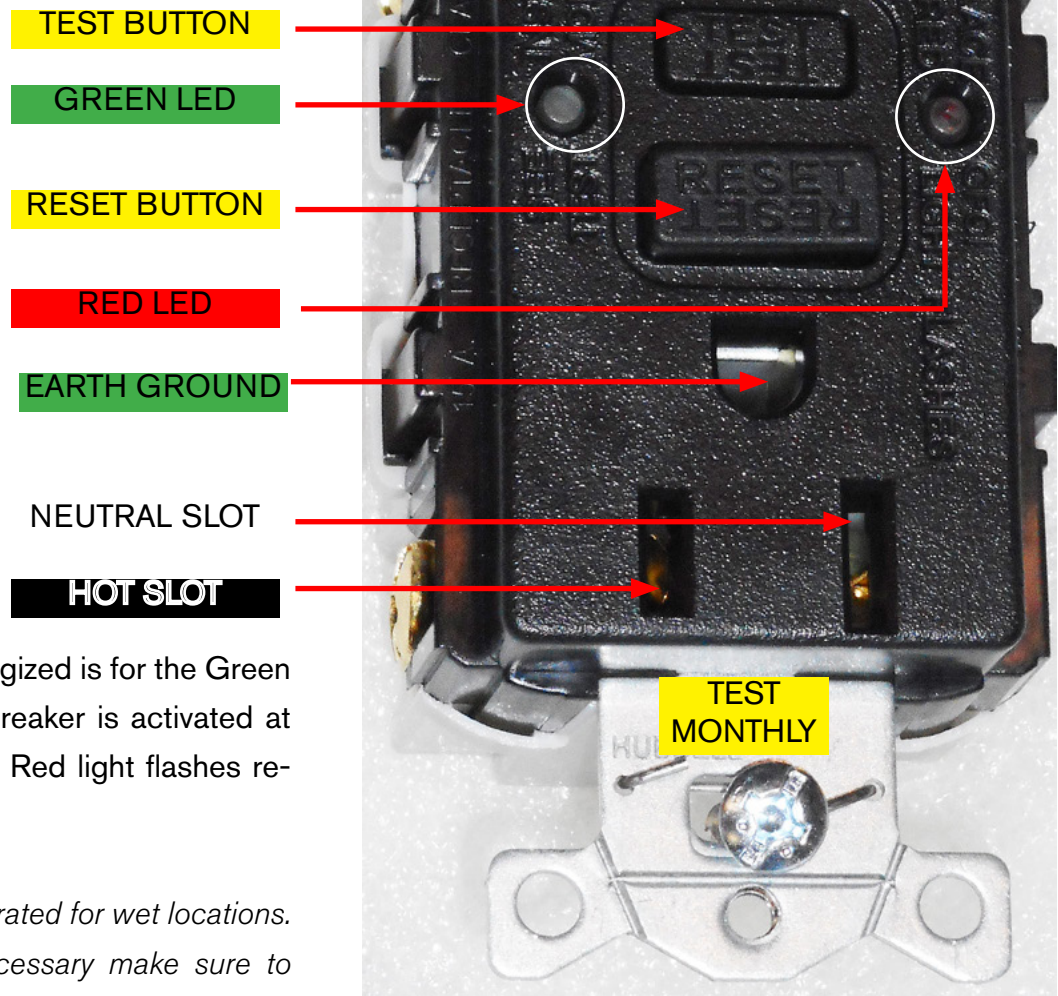

Normal operation when energized is for the Green LED to light as the outlet breaker is activated at the main AC ship's panel. If Red light flashes replace GFCI receptacle.

Note that current GFCI's are rated for wet locations. If replacement becomes necessary make sure to match the amperage and location requirements.

Note that it is normal over the life of a GFIC to develop corrosion on the contacts due to the marine environment which may lead to device failure.

GFCI Outlet Continued

Testing GFCI'S

To test a GFCI find a 120 volt night light or small lamp to plug into the GFCI outlet. Try it in another circuit first to make sure it lights.

After the lamp is plugged into the GFCI outlet the lamp should light. Now press the “test” button at the GFCI receptacle center. The GFCI's “reset” button should pop out and the lamp should go out. This means the GFCI itself is functioning properly. Press the “reset” button to restore power to the outlet. Test each GFCI circuit monthly.

You can use the lamp to check receptacles downstream from the GFCI. All receptacles should light the lamp and should go out when the “test” button is pressed.



Also, GFCI downstream receptacles can be tested with a plug-in type GFCI tester. This tester contains a GFCI test button which accomplishes the

same thing as the GFCI receptacle built-in test button. This tester can be purchased at electrical supply houses or marine retailers.

Ignition Protected Devices

Many electrical devices in everyday use tend to “arc” or spark when being used. These include motors, fans, switches, relays, etc.

Boats in general use many of these same devices but they are protected from any sparking that may cause the device to ignite with any vapors that are typically found in the engine room and/or fuel tank compartments.

When replacing any electrical device especially in the bilge or engine room make sure it is ignition protected. This means it has been tested and normally the device is stamped with a marking making it safe to use. Most automotive type devices are not ignition protected especially engine starters and alternators.

Note smaller hose barb for generator feed and return.

Possible Problems/solutions (GFCI's)

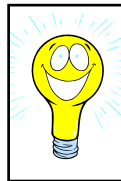

1. If the “reset” button does not pop out, the GFCI is probably defective and should be replaced.
2. If the “reset” button pops out one time but tends to stick the next the GFCI should be replaced.
3. The GFCI “reset” button pops out when something is turned on. This may indicate an internal wiring problem with the GFCI or there may be a ground-fault downstream.
4. The GFCI “reset” button is in the pressed position and nothing works. Check the appropriate breaker at the main ship's AC control panel to make sure it has not “tripped” or as been deactivated.

Galvanic Isolator (Typical)

As part of the AC boat circuitry the green ground wire takes a different path. It enters via the boat's shore power inlet and travels to a galvanic isolator. Isolator is located behind the cabin main AC panel.



A 60 amp (60 hertz) galvanic isolator for domestic use is connected in series with the AC grounding "green" wire. The purpose of the galvanic isolator is to isolate the boat's grounding system electrically from the dock and other vessels below 1.4 volts but to maintain a connection to the shore green ground at high voltage potentials. The low voltage isolation will prevent the vessel's zinc from protecting the underwater metal hardware on another vessel sharing the same AC common green ground wire. This eliminates the possibility of galvanic interaction from other boats on the same dock circuit and permits your anodes to protect your boat.

The green ground or "bonding wire" runs from the boat's shore power inlet to a galvanic isolator stud. From the other stud of the galvanic isolator it runs to the AC ground buss located behind the AC main ship's control panel in the salon. Note that the stud nuts must be torqued and maintained at 8.8 inch pounds.

Since the galvanic isolator is not polarized either terminal can be used for the inlet or outlet side for the green grounding wire. See the illustration.

There is a fan located at the right side of the isolator identified by an array of ventilation holes. If you ever hear the fan running the isolator has failed. Disconnect shore power at boat & check system.

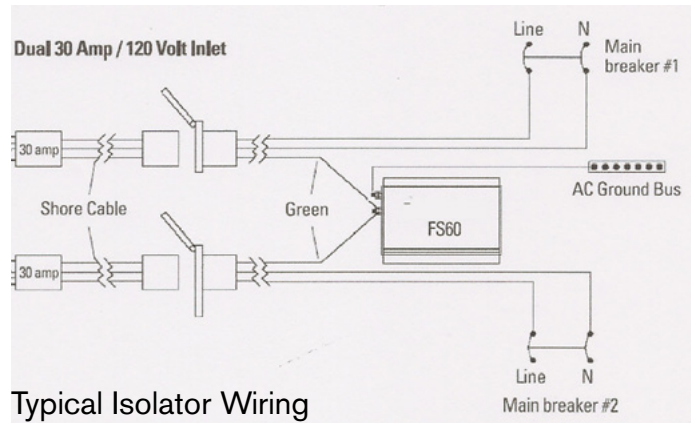

Typical Isolator Wiring

Precautions/Galvanic Isolator Warnings

Warning- It is extremely dangerous to swim or be in the marina water due to potential AC current that may be present in the water. Take all necessary precautions as this may be life threatening.

Caution- This device does not provide a status monitor. Following a lightning strike this unit may not continue to provide galvanic isolation protection.

Warning: The fan will operate only when there is a fault to ground and the isolator is conducting current. If you notice the fan running immediately disconnect the shore power and contact a qualified marine electrician to isolate and repair the problem with the boat or the shore power connection. Remember, never cover the fan holes.

Caution: Never test the galvanic isolator. Troubleshooting the galvanic isolator shall be done by qualified personnel only.

AC Generator-Typical

Overview

The following information is regarding the gas generator. If installed the gas generator (gen-set) is used to provide on board alternating current (AC) when the vessel is unplugged from the dock side cord. Generator frequency known as hertz is domestically set at 60 while overseas countries normally require a setting of 50. As the gas generator reaches full rated no load output (amps) at 60 hertz it should display 120 volts. At 50 hertz it should display 230 volts.

The generator is located in the bilge accessible through the Lazarette storage hatch.



GAS GENERATOR

Note that the optional diesel generator features a 30 gallon diesel fuel tank.

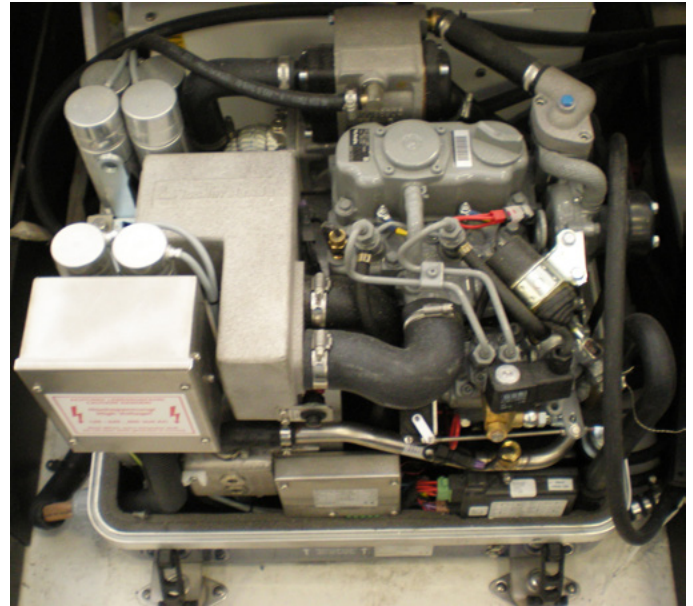

DIESEL GENERATOR

For diesel generator refer to your diesel generator operator's manual.



WARNING

PREVENT INJURY OR DEATH
DUE TO FIRE OR EXPLOSION!
RUN BLOWER AT LEAST 4
MINUTES BEFORE STARTING ENGINE.



WARNING

GASOLINE VAPORS CAN EXPLODE!
BEFORE STARTING ENGINE
CHECK BILGE COMPARTMENTS
FOR GASOLINE LEAKS OR VAPORS.

Ventilation System Notes

When an outboard vessel features a gas generator a powered ventilation system is used on board to dissipate any gasoline vapors.

The powered ventilation system with the use of blowers evacuate air from the lower third of the bilge where any gas fumes may exist. Intake and exhaust ducting is used in this process. The blower switch is found at the ship's main panel.

Always preform a bilge sniff test before starting generator. If the sniff test is positive deactivate all sources of power at the battery activation panel and seek professional assistance immediately to locate the source of vapor leakage! Do not attempt to start generator!!!!

Anytime the generator is operated the blowers need to be run before starting the generator and during operation of the generator. Read and understand the warning label below.

 WARNING
PREVENT INJURY OR DEATH DUE TO FIRE OR EXPLOSION! RUN BLOWER AT LEAST 4 MINUTES BEFORE STARTING ENGINE. CONTINUE TO RUN BLOWER WHEN GENERATOR IS OPERATING.

Periodic maintenance of the powered ventilation includes examining the intake and exhaust ducts for any obstructions such as debris or insect nests inside the ducting.

Make sure the exhaust hoses extend into the lower third of the bilge and they are not damaged in any way.

Never obstruct any part of the ventilation system!

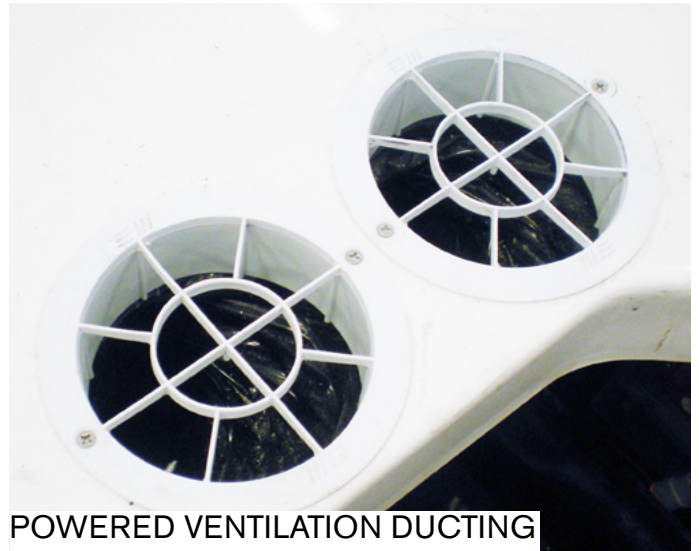

Note on the 38 SAV with the Lazarette hatch lifted the exhaust ducting for the powered ventilation system is to the starboard aft. The ducts can be recognized by the 4" black hoses attached to the lower portion of the duct fittings to reach the lower third of the bilge.

The intake ducting for the powered ventilation system is located to the port aft and may not have hoses attached to the fittings.

Typical Generator Fuel System

The gas generator is supplied by the same fuel tanks as the engines. The generator feed valve is normally marked for identification purposes.

Familiarize yourself with the location of all equipment and valves.

Note: Normally the generator feed and return use a 1/4"inch barb fitting located on the fuel tank. The feed portion will use a anti-siphon valve.



The fuel system features an in-line fuel filter located close to the generator. It's job is to keep fine particles and water out of the generator fuel system. Refer to the vendor information for periodic maintenance schedules. Clean fuel is the life line of generator performance.

Since water is heavier than fuel it will settle at the bottom of the water separator filter. Periodically check the filter for foreign debris and water in the fuel supply. To check the filter unscrew the filter using an oil filter type wrench that fits on the bottom. Do not use a strap type wrench since it may distort or damage the filter housing. Use an environmentally safe container to catch any contaminated fuel. Dispose of according to local, or state regulations. Carry extra water separator filters on board. When you turn the filter upside down note that any water in the gasoline will gather at the bottom of the container since it is heavier than gasoline and will appear as a different color and consistency and normally will move back and forth independently from the gasoline mixture in the container.

After inspection spin on the filter by hand until tight. Start the engine and check for fuel or air leaks.



WARNING

USE OF ALCOHOL ENHANCED FUEL, OR ANY FUEL OTHER THAN GASOLINE CAN LEAD TO DETERIORATION OF THE FUEL SYSTEM COMPONENTS. THIS CAN RESULT IN FIRE AND POSSIBLE EXPLOSION.



WARNING

GASOLINE VAPORS CAN EXPLODE!
BEFORE STARTING ENGINE
CHECK BILGE COMPARTMENTS
FOR GASOLINE LEAKS OR VAPORS.



WARNING

PREVENT INJURY OR DEATH
DUE TO FIRE OR EXPLOSION!
RUN BLOWER AT LEAST 4
MINUTES BEFORE STARTING ENGINE.

Typical Generator Electrical System

The generator starting system uses the house battery. The generator is normally started at the 12 volt ship's control panel located in the cabin but it can also be started using the remote instrument panel located at the generator itself as needed. The latter is especially useful while maintenance is being conducted.

The generator remote instrument panel normally features temperature, oil pressure, exhaust, speed, hour meter, on/off, start and stop switches. This panel is found inside the access door on the generator sound enclosure in the bilge. The start and stop switches by name and function are identical to the switches on the remote panel.

As part of the generator electrical system a fuse protects the remote instrument panel wiring circuit. See illustration.

The emergency stop switch shuts the fuel off to both the remote and ship's main control panel and is normally for maintenance purposes.

A DC manual reset breaker protects excessive current draw or electrical overload anywhere in the generator engine wiring. Should this breaker trip the generator will shut down. Reset the breaker only after the cause of the problem has been determined. See illustration.

An AC breaker will automatically disconnect any generator AC power from reaching the main ship's control panel in case of an electrical overload. It can be manually shut off when performing generator maintenance to ensure no AC power is coming out of the generator. See illustration.



WARNING

TO PREVENT POSSIBLE GENERATOR DAMAGE ALL SHORE POWER BREAKERS AND AC SWITCHES NEED TO BE DEACTIVATED BEFORE STARTING OR STOPPING GENERATOR.

Before Starting Generator

The following items should be checked each time before starting the generator. This covers the basic system components.

- ✓ Turn generator sea cock off. Check strainer for debris. Turn generator sea cock on before starting it.
- ✓ Ensure that all main panel and equipment breakers are off.
- ✓ Inspect the generator for fuel, oil, exhaust or water leaks.
- ✓ Check generator engine oil level. Top off with correct viscosity as required.
- ✓ Check coolant for proper level at recovery tank. Add as needed.
- ✓ Check the main fuel tank to ensure there is adequate gasoline for both the generator and the engines. Apply the one-third rule.
- ✓ Check for loose wires at the alternator.
- ✓ Check the port side cranking battery (weekly).
- ✓ Check drive belts for wear and proper tension (weekly).
- ✓ Record the hour meter reading to meet maintenance scheduling.
- ✓ Check the blower for proper operation. Start blower and let run at least 4 minutes before attempting to start the generator. Run blower continuously while generator is running.
- ✓ Check the water surrounding the aft platform for persons in the water. Do not attempt to start the generator with persons in the water as generator exhaust could overcome the individual with CO poisoning and lead to drowning. Never let persons near the generator exhaust which is located on the starboard transom.

Typical Generator Exhaust System

The generator exhaust system features a dual tier operation. As the water and exhaust exit the generator they travel to the muffler. The muffler discharges the heavier water out the muffler bottom and through the hull. The exhaust itself is exited out the muffler top and through the hull. The benefits of the system are two-fold. First, the actual decibel or sound level is decreased. In addition, the lower resonating sound is more pleasing to the ear. For colder climates, a drain plug is installed in the muffler.

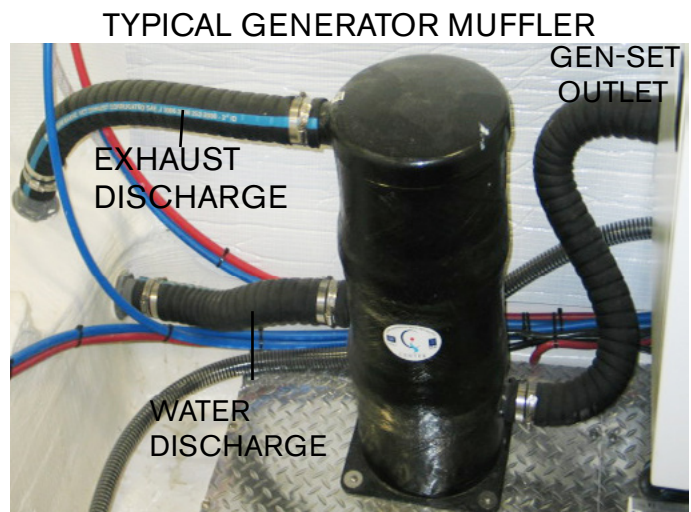

Before departure always check the hose connections for signs of water and air leaks. Tighten hose clamps periodically as needed. Check entire exhaust system for leaks and fastener tightness. After starting generator, check for water flow at the generator discharge.

Starting Generator

The following generator starting information is specified for use at the ship's main control panel located in the cabin. *It also assumes that the checklist on the last page has been completed and all system components are in good running condition.* For further information, contact your closest Regal dealer, refer to the generator operation manual and/or the illustration of the ship's panel.

1. Turn "on" the generator sea cock in the engine room.
2. Check the ship's main control panel to ensure shore main and all equipment breakers are deactivated.
3. At the ship's main control panel activate the generator blower. Let it run for at least 4 minutes before starting the generator.
4. Activate the toggled "start" switch and hold. This will engage the generator starter to crank over the gen-set engine.
5. Once the generator starts, release the "start" switch.
6. Let the generator run without a load for several minutes.
7. At the ship's main control panel slide the starboard parallel (transfer) bar up.. Activate the breaker.
8. Push the port bar up. Activate the generator breaker.
At this point AC voltage should display on the AC line voltage meter.
9. Activate the desired AC equipment breakers.

Stopping Generator

To stop the generator follow these steps at the ship's main control panel;

1. Turn to the "off" position all AC equipment breakers.
2. Turn to the "off" position the 50 amp AC generator breaker. At this point, no AC line voltage will be displayed at the AC volt meter. Let the generator run for 3-5 minutes without a load to cool down.
3. Stop the generator by activating the "stop" switch on the panel. Hold switch until generator stops.

Possible Generator Problems/Solutions



1. With generator main control panel activated there is no voltage at the AC line voltage meter. Check AC output breaker on the generator. It may of tripped due to an overload.

2. The generator quit do to overheating. Check the generator strainer for obstructions such as seaweed, plastic, or shellfish. Be sure to turn off sea cock before removing the strainer basket.

3. The generator will not start from the main ship's panel after being serviced. Make sure the generator mounted emergency stop switch is in the "off" position and the breaker has not tripped..

4. The generator will not crank over to start. Check-out the house accessory battery and remote battery switch.

Generator Seacock/Strainer



To service any onboard strainer make sure the seacock handle is in the "off" position at a 90 degree angle to the hose. Turn the strainer top counterclockwise to access the basket, Pull the basket out and remove any debris. Reinstall basket and tighten

strainer top. Set the sea cock handle to the "open" position. Start generator and check for leaks.



CLEANING STRAINER BASKET

Air Conditioning

The current air conditioning system features domestically a 12,000 BTU output at 120 volts and 60 Hz. The system utilizes a single pump which delivers cooler seawater to the evaporator/condenser. The drain pan is rust free molded composite. Residue water exits through the shower box. Warmer seawater exits the vessel through a manifold and various thru-hull fittings.

A vibration isolation system reduces noise. The sound cover provides up to 50% further noise reduction which amounts to 3-5 DB's.

The evaporator/condenser unit incorporates a compressor to compact the R-410A refrigerant which is comprised of fluorinated greenhouse gases.

The Elite control panel (thermostat) is centrally located in the cabin to serve the vessel needs. A set of control panel reference system codes is provided for any type of service issue.

The A/C pump is located in the engine room. It provides sea water to operate the A/C unit located under the forward berth floor.

Note: If the vessel is hoisted out of the water (except for winterization) make sure the A/C sea cock is turned to the "off" position before lifting the vessel. Failure to do so may cause the air conditioner to lose its prime and the A/C pump may quit on start-up do to a lack of water or cause pump failure. Remember to turn the sea cock "on" before re-starting the A/C unit.

TYPICAL AIR CONDITIONING EVAPORATOR/CONDENSER UNIT

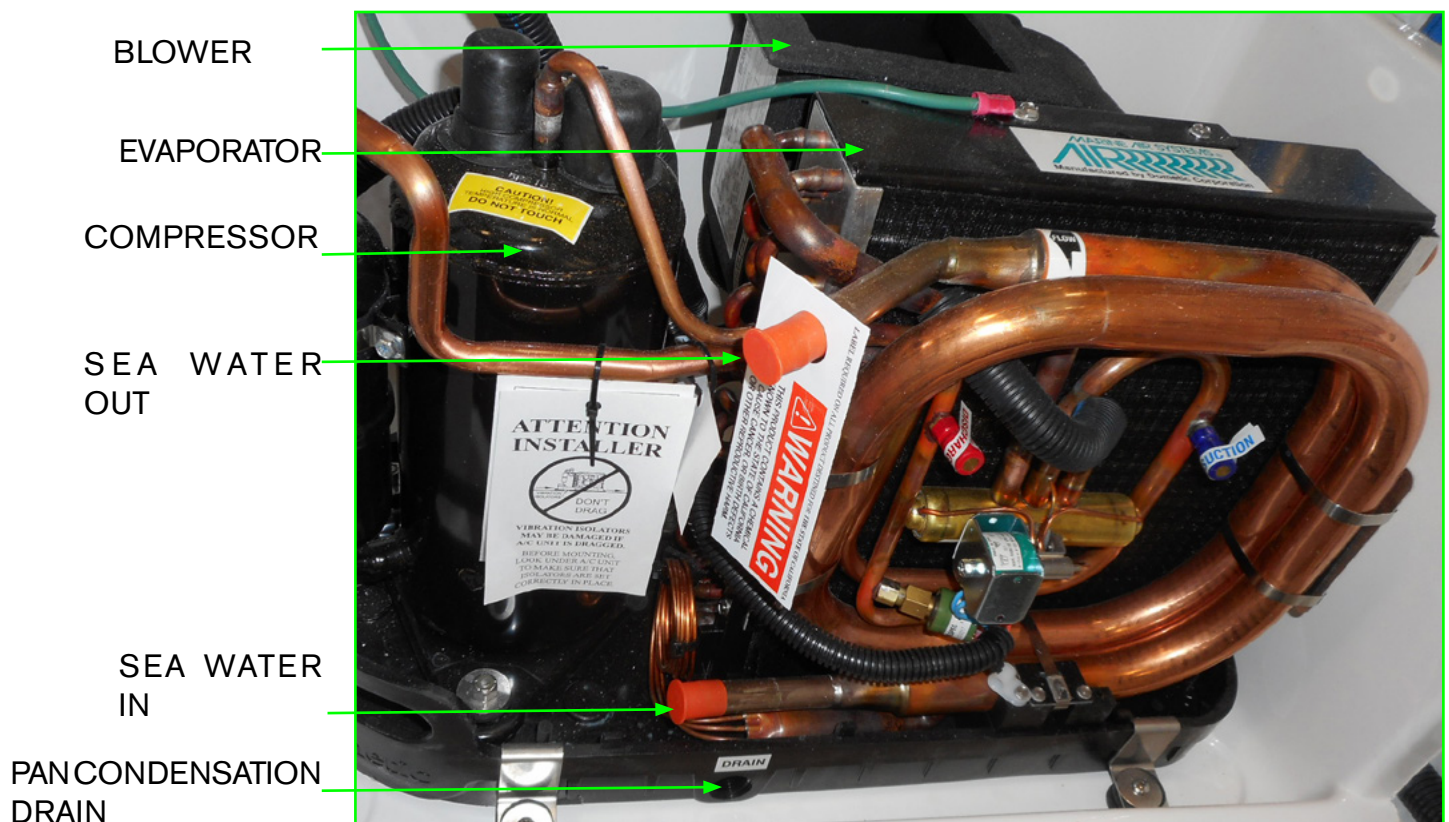

Reverse Heat

The air conditioning system feature a reverse heat cycle. This can be extremely valuable to boaters in colder climates especially for early spring and late fall cruising.

To accomplish reverse cycle heating, the R-410A refrigerant flows in the opposite direction through a reversing valve located on the evaporator/condenser unit. Heat is transferred from the seawater in the coil of the condenser to the R-410A refrigerant and then to the air as it is blown through the evaporator to the cabin.

Obviously, the temperature of the seawater will affect the air conditioner efficiency.

The temperature variance for cooling efficiency is:

Up to 90 Degrees F. (32.2 Degrees C.)

The temperature variance for heating efficiency is:

Down to 40 Degrees F. (4.4 Degrees C.)

Typical Air Conditioning System Operation

Below is a basic quick start-up checklist for the air conditioning system.

Operations Quick Start-Up Checklist:

1. Check the AC seawater strainer for debris.
2. Make sure the AC seawater pump sea cock located in the engine room is opened completely (handle should be in-line with the hose).
3. Activate the forward air conditioner breaker on the boat's main AC control panel located on the cabin wall.
4. Check the hull side for a steady stream of seawater. Seeing water here is normal when the AC pump is running. If stream is diminished or no water emits from the fitting immediately turn the AC pump off and investigate the cause of the problem.
5. Press the Elite thermostat Power button once to activate the air conditioning system. A blank screen displays when system is off and indicates present cabin temperature.
6. For cooling or heating press and release the Mode button until the desired LED is illuminated ie; automatic mode.
7. Press the Up or Down button to set the desired cabin temperature. To view the set point, momentarily press and release the Up or Down button.
8. Auto fan LED lights when Auto fan speed is selected.

TYPICAL ELITE AC CONTROL DIAGRAM

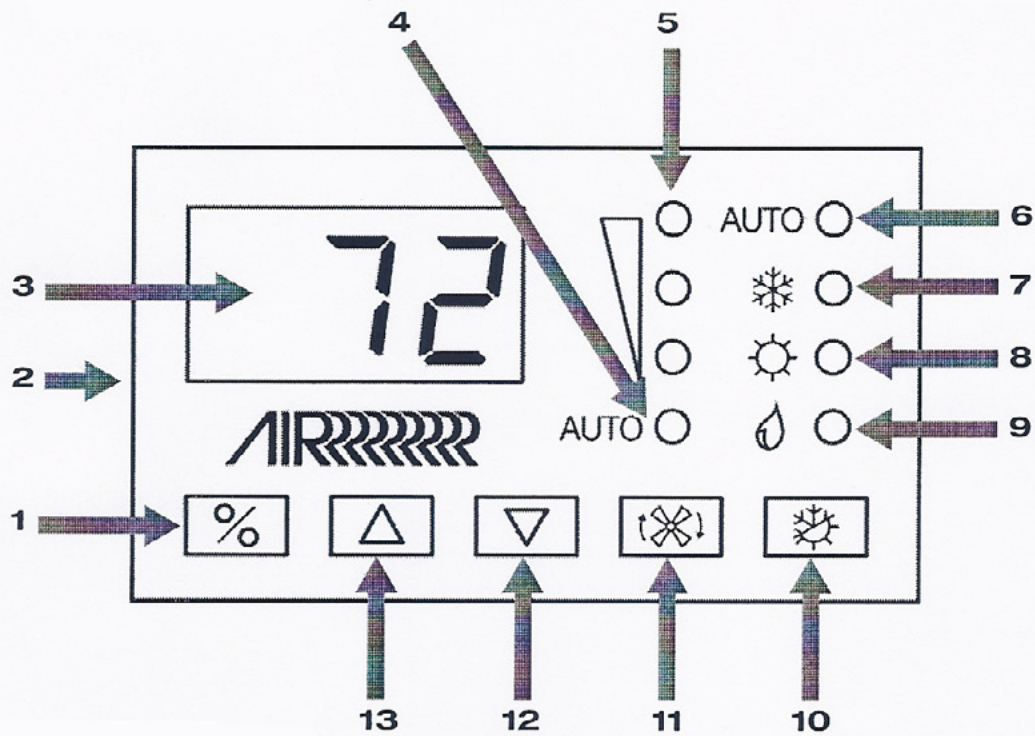

Elite Display - Diagram Legend

1	Power button	8	Heat Mode indicator
2	Temperature sensor	9	Moisture Mode indicator
3	Digital display	10	Mode button
4	Auto Fan indicator	11	Fan button
5	Manual Fan indicator (high, medium, low)	12	Down button - Lower temperature set point
6	Auto Mode indicator	13	Up button - Raise temperature set point
7	Cool Mode indicator		



Note: The Elite display continually monitors the system components. Should a problem develop it sends a diagnostic code to the control (thermostat) display. Refer to the vendor air conditioning manual (troubleshooting section) to assist in identifying the problem.

Typical Air Conditioner Inspection Tips

Seawater Strainer

The air conditioner seawater strainer is located in the bilge and should be cleaned periodically of debris which can inhibit or stop the fresh sea water supply.

Always turn the sea cock handle to the off position (90 degrees to the hose fitting) before cleaning a seawater strainer.

Remove the basket by turning the plastic cap in a counterclockwise direction. Set the cap and the O ring aside. Pull the basket from the unit, rinse with water, air dry and reinstall. Sediment at the bottom can be removed by just turning the plug in a counterclockwise direction. Place a container under the strainer to catch the sediment. Coat the O rings with waterproof grease containing a silicone or teflon base. Reinstall O rings along with the plug and plastic cap. Turn on and check for leaks.

Return Air Filters

Once a month check the return air filter located on the face of the evaporator. To clean rinse with fresh water, air dry and reinstall.

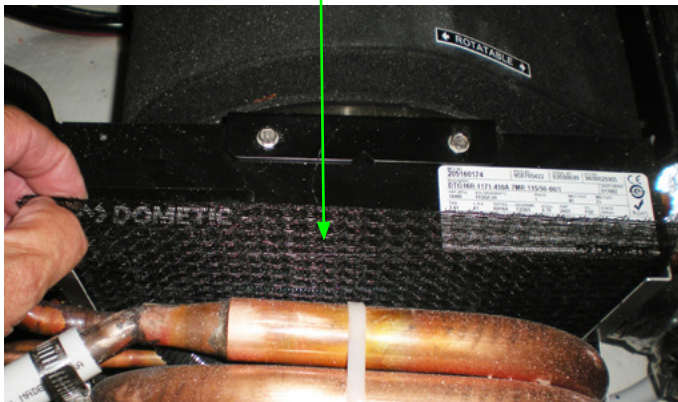

Drain Pans

As noted on an earlier page the AC evaporator/condenser features a 2" deep drain pan connected by a hose that runs to a sump pump and eventually exits overboard. Periodically just like your home AC, the pan needs to be rinsed clean of debris and possible mold.

You can use a purchased product made specifically for cleaning AC units. Disconnect the outlet hose from the AC pan and install made up hose (5/8") that will catch the used solution to fill a small container. Dispose of the container in accordance with federal, state and local regulations. Pour the solution into the pan and allow time for it to drain. Reconnect the original drain pan hose when finished.

Condenser Coil Cleaning

Periodically the condenser coils are recommended to be cleaned. This procedure should be performed by a professional since an acid solution must be used.



WARNING

PREVENT INJURY OR DEATH!
DISCONNECT
ALL ELECTRICAL POWER SOURCES
BEFORE ATTEMPTING
TO OPEN, REPAIR, OR REPLACE ANY
AIR CONDITIONER COMPONENTS.

Possible Air Conditioner Problems/Solutions

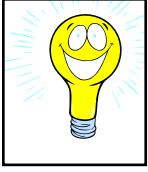

1. No or little water is noticed at the thru-hull fittings and a HPF fault code shows on the display which means the high pressure switch is open.

The strainer or intake hose may be clogged, sea cock may be closed a hose may be collapsed or the AC pump may be defective.

2. Air conditioner will not start. Ensure the proper AC breaker is activated on the ship's main control panel.

3. No cooling or heating. Lower or raise set point on thermostat control to offset set point being satisfied. Check for obstructed seawater flow. Remove discharge side of pump hose to purge air (air-lock). Seawater temperature too high for cooling and too low for heating.

4. Fan coil is iced. Raise or lower control set point. Clean return air filter. Switch AC to heat until ice melts or as a last resort use a hair dryer to melt ice as needed.

Gasoline Fuel System

In this section, a typical EPA approved domestic gasoline fuel system is introduced. The fuel system includes the fuel tank, fuel feed lines, fill and vent fittings along with fuel filters, emission devices, natural and powered ventilation systems.

Gasoline today is processed in a different manner than it was a few years ago. As a result it has become more unstable and the product shelf life has been shortened.



Outboards in this size range normally utilize a metal fuel tank. A special low permeability bulb and hose is

supplied by the engine manufacturer to feed the fuel from the tank to the outboard engine. Sometimes it is necessary to pump the gas line hose bulb before starting the engine. *Note that the fuel line bulb and hose for each engine is in the lazarette storage area.* If the need arises to replace the fuel bulb be sure to turn the arrow imprinted on the bulb toward the engine side for correct fuel flow.

Read and understand the outboard owner's manual fuel section and safety information before attempting to use the vessel.

Note that due to a possible fire or explosion danger never store flammable liquids and/or portable outboard fuel tanks in any onboard storage compartment such as the cockpit Lazarette locker.

Gasoline Specifications/Octane Ratings:

Gasoline Requirements- Use premium non-leaded gasoline with the following minimum octane rating for Yamaha outboard engines:

• Minimum pump octane number (PON) is 89.

The use of leaded fuels will damage the catalysts and can not be used with catalytic converters.

Gasoline in the United States and other areas is blended with 10% ethanol and is known as E-10 at the pumps. Marine engines used in your Regal boat may be operated with premium unleaded gasoline blended with no more than 10% ethanol and that meets the minimum octane specification.

Do not use ethanol blends greater than 10% such as a newer blend for select motor vehicles called E-15. Your marine engine may be damaged by more than 10% ethanol. A loss of performance may occur and the engine will not be covered by the engine manufacturer's warranty.

Refer to your outboard manufacturer's operation manual for additional information regarding the proper octane level for your outboard model. Using the wrong octane level may cause permanent engine damage such as piston detonation.

As an option contact your outboard manufacturer's hot line or surf the web with fuel related questions. Also, additional fuel system information may be as close as your Regal dealer. Your Regal dealer has special training on the propulsion and Regal vessel systems.

Typical EPA Outboard Fuel System

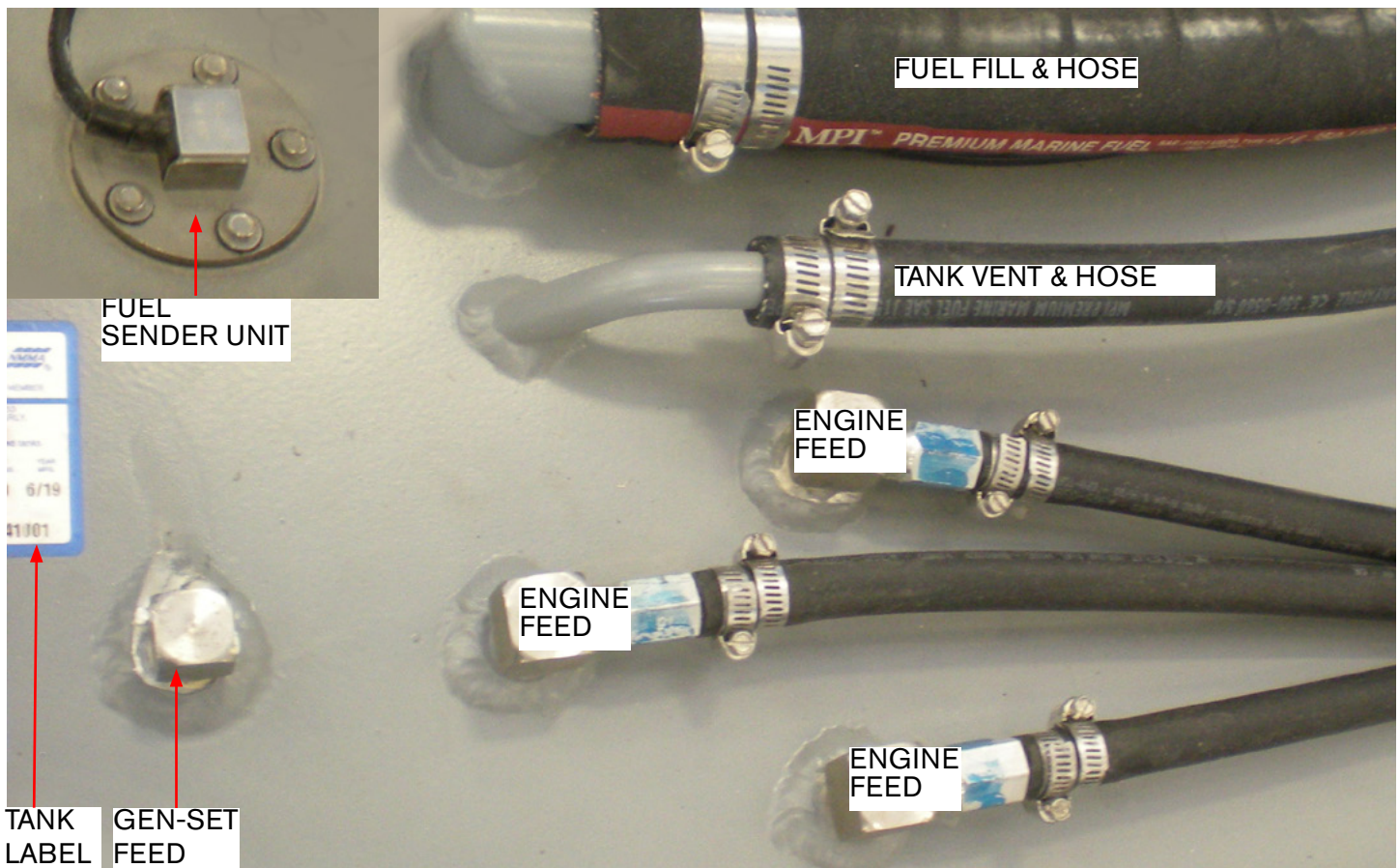

Typical Fuel Tank

Vessels manufactured for *domestic* use are now required to be outfitted with an EPA compliant fuel system using an aluminum tank that passes a variety of tests. This system uses special valves and baffles located inside the fuel tank along with special hoses marked for low permeability. Also, there is a carbon canister in-line with the vent hose which functions much like the one in an automobile by filtering gas fumes. The carbon canister rarely needs to be replaced and is not a serviceable item.

These tanks are tested and inspected along with the complete fuel system several times for safety requirements and quality by the fuel tank supplier, in house personnel and independent inspections by National Marine Manufacturers Association personnel.

Fuel Fill Fitting

The fuel fill fitting is labeled “gas” and in addition displays the international symbol (See the next page). When fueling the boat keep the fill nozzle in contact with the fuel fill pipe since it decreases effects of static electricity. Always use the recommended fuel octane rating as specified in your engine owner’s manual.

Extinguish all flame producing agents before fueling!

 **WARNING**

AVOID SERIOUS INJURY OR DEATH FROM FIRE OR EXPLOSION, RESULTING FROM LEAKING FUEL. INSPECT SYSTEM FOR LEAKS AT LEAST ONCE A YEAR.

Fuel Vent Fitting - Typical



COMBO FUEL FILL/
INTERNAL VENT

Currently, domestic EPA compliant fuel tanks vent fumes back into the fuel tank system. While the tank is filled, air displaced by the incoming fuel is vented through the fuel system charcoal canister.

Your vessel uses a combo type (internal vented) fuel fill. Both the fuel fill and vent occupy the same cavity under a protective cover. If fuel overflows through the vent the design forces it back into the fuel fill hose and tank. Be sure to tighten the fuel fill cap to prevent water and debris from entering the fill system.

A seasoned skipper will hear a distinct sound as the tank nears the “top out” or full mode and may see fuel overflowing back into the fuel hose through the vent. On select vessels not using an EPA fuel system there may be a separate vent fitting on the hull side. Periodically check this vent screen for debris and insect activity.

NOTICE

DO NOT OVERFILL THE FUEL TANK!
THIS HELPS AVOID ANY OVERBOARD
SPILLS WHICH MAY HARM THE
ENVIRONMENT

Anti-Siphon Valve

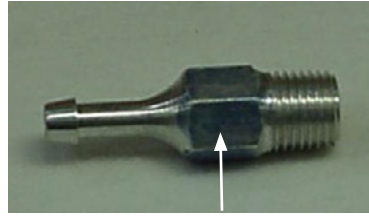

INTERNAL BALL/SPRING

The gasoline fuel tank feed line that runs from the fuel tank to an engine or generator fuel component uses an

anti-siphon valve. The valve is threaded into the fuel tank fitting at the feed line. The valve is pulled off its seat by fuel pump pressure as the engine is cranking or running. There is a ball and spring assembly inside the valve that is activated by fuel pump impulses. It allows a one-way fuel roadway to the engine or generator fuel system. It prevents fuel from siphoning out of the tank in the event of a fuel line rupture or disconnected fuel feed hose. When the engine fuel components stop the fuel from cycling the spring forces the ball against the valve opening to prohibit fuel flow.

Never remove an anti-siphon valve as it is a fuel system safety component. Also, never remove the ball and spring from the valve assembly. The anti-siphon valve requires no normal maintenance. Symptoms indicating possible valve problems may be fuel starvation at intermediate or high rpm or in extreme cases an engine that will not start.

Contact your Regal dealer for further information.

Fuel Gauge & Sending Unit



WARNING

PREVENT INJURY OR DEATH!
READ AND UNDERSTAND THE
PROPULSION AND GENERATOR OWNER'S
MANUAL BEFORE ATTEMPTING
TO OPERATE THE VESSEL.

Fuel Storage On Board



WARNING

PREVENT INJURY OR DEATH!
NO VENTILATION PROVIDED IN STORAGE
COMPARTMENTS. FUEL VAPORS
ARE A FIRE AND EXPLOSION HAZARD.
DO NOT STORE FUELS, FLAMMABLE LIQUIDS
OR PORTABLE FUEL TANKS ON BOARD!

Fuel Filters



Fuel filters are found on outboards under the motor shroud (cover) which should be serviced periodically per the outboard motor manufacturer's instructions. In addition, Regal installs an in-line 10 micron water separator filter which is

a spin on-off type similar to an automobile oil filter. Its main purpose is to trap small dirt particles and condensation (water) in fuel. It is a good idea to keep extra fuel filters on board along with a strap style filter wrench, catch container and clean rags for emergencies. Never use automotive style fuel filters on your vessel. Dispose of all fuel residue materials in an environmentally safe fashion.

These filters are available on-line, through marinas, retail marine outlets, or can be ordered via your closest Regal outboard dealer.

Read and understand the label above regarding the storage of flammables on board the vessel. Also, do not store auxiliary portable fuel tanks on board the vessel since these portable tanks emit vapors into the atmosphere.

Fresh (Potable) Water System

Overview

There is a fresh water supply onboard known as a potable (drinkable) water system. The system includes a 32 gallon fresh water tank/sender, fresh water pressure pump/filter along with various hoses, connectors, fill/vent hardware, faucets, and a monitor panel. We will review the main system components to aid in understanding how the system works.

Note that various components in the fresh water system require periodic maintenance to ensure the system continues to run effectively.

Fresh Water Tank

Normally the fresh water tank is manufactured from aluminum for increased strength and longevity. The tank utilizes a sender which senses the tank water level and displays an approximate amount on the fresh water section of the monitor panel. Refer to the typical fresh water tank components shown in the photo.

Fresh Water Fill/Vent



The fresh water tank fill is normally located on the starboard deck with a nearby system vent. Simply remove the cap on the fill labeled

“water” and fill with fresh water until you see water exiting through the vent. This tells you the potable water tank is full and ready for use. Tighten the cap when finished filling system to keep debris out of the tank. Always line up the 2 blue dots for complete fitting closure.

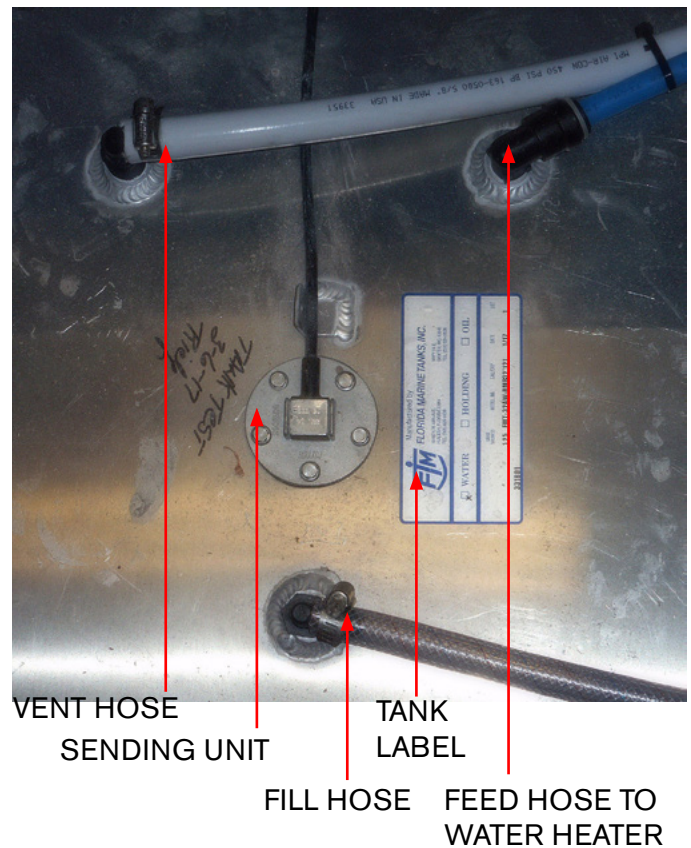

Sending Unit

Note there is a fresh water sending unit located on the tank top. This sending unit measures the amount of available potable water and sends a signal to the monitor panel. When the top portion of the monitor panel switch is pressed the gauge shows the amount of water in the fresh water tank. This reading is approximate as there is a margin of error involved. Always check the monitor panel fresh water level before each outing or extended cruises.

Fresh Water Feed Hose

The fresh water feed hose runs from the fresh water tank to the fresh water pressure pump. It is normally a blue hose which signifies “cold water”.

Fresh Water Pressure Pump

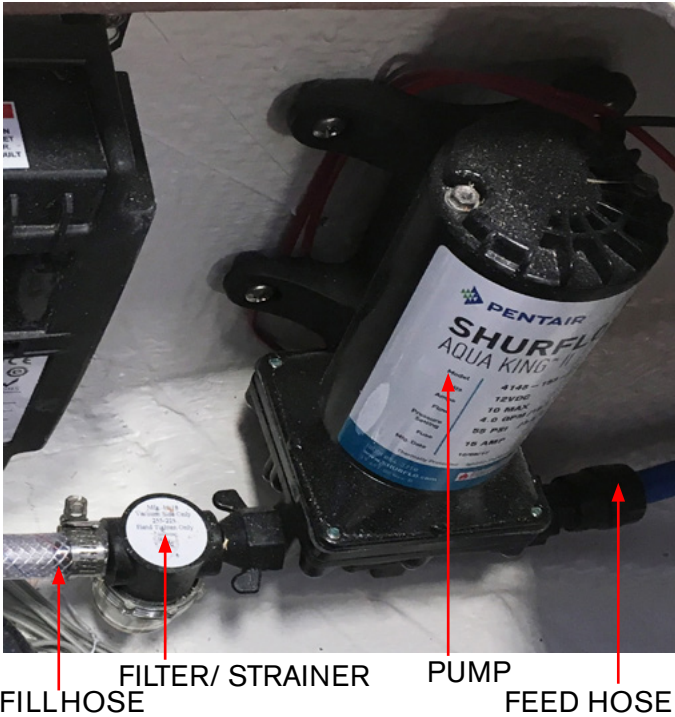

Operation

The 12 volt fresh water pump supplies potable water to various fresh water components on the vessel. At the helm panel a fresh water switch controls the wash down hose located under the port gunnel along with sink faucets normally located in the cockpit and head. Also, the transom shower utilizes the fresh water pump. The fresh water switch must be activated for any of the above components to operate.

Note that there is also a raw water pump which supplies water to the bait and fish wells.

Periodically the water filter strainer located near the fresh water pump needs to be serviced. Inside the filter there may be a screen which needs to be cleaned of any debris and rinsed off with fresh water before reinstalling it.

A majority of these pressure pumps use a switch which disengages the fresh water pump after it reaches a predetermined line pressure. If the fresh water pump continues to run continuously it may be a result of the following:

- A faulty internal pressure relief valve
- A faucet on board not turned off
- A broken line or loose line connection

It is recommended that the fresh water pressure pump switch be in the “off” position when leaving your boat to help prevent damage should a leak develop in the cold water system.

NOTICE

AVOID COMPONENT DAMAGE!
NEVER RUN THE FRESH WATER PUMP
WITHOUT WATER IN THE FRESH WATER
TANK AS PUMP IMPELLER DAMAGE
MAY OCCUR.

Using Fresh Water System With Tank Only

This approach is mainly used while cruising without the ability to draw from a marina or public water supply by attaching a garden hose to the city water valve. Also, use this approach when you are unsure of the purity and /or source of the water supply for drinking.

1. Verify through the monitor panel that the fresh water tank is full by activating the upper portion of the toggle switch.

2. At the helm switch panel activate the fresh water system switch. This will energize the water pressure pump to send fresh water from the potable water tank through the cold water lines terminating at the various faucets and related components.

3. Open a faucet. Water pressure should be present. Opening the faucet for a few seconds will purge any air in the system especially in cases where the fresh water tank has run out of water. When water is running at a faucet it is not unusual to hear the water pump activate as it is trying to build up the pressure required in the system. Soon after the faucet is turned off the fresh water pump sound will end indicating the fresh water system is now up to specified system pressure.

Note not to run pressure water pump with system dry as water pump component damage may occur.



This potable water system features a deck mounted fill and vent. Ensure the water supply is drinkable before attempting to fill the potable water tank.

The tank levels can be monitored on the Garmin display when filling the tank.

Note the blue dots on the fresh water fill fitting. When finished filling the potable water tank screw in the plug until the 2 blue dots line up which indicate the fitting is completely closed. This will reduce the possibility to any foreign debris entering the potable water system.

Note to periodically check the water fill vent located on the hull side for obstructions such as insect activity and debris.

 **CAUTION**

PREVENT PROPERTY DAMAGE!
DISCONNECT
THE DOCK SIDE WATER INLET HOSE
BEFORE LEAVING THE VESSEL.

Using Fresh Water System With City Water Valve)

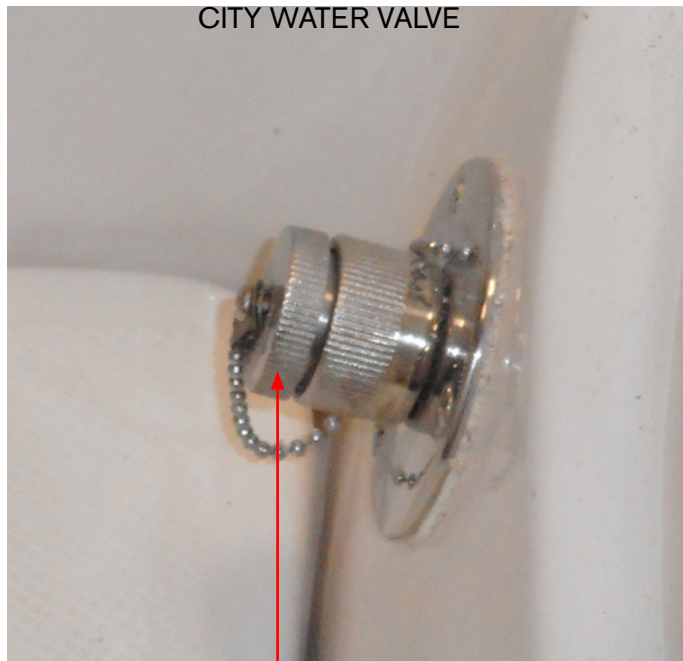

TURN COUNTER CLOCKWISE TO OPEN

Use this procedure when at the dock, mooring or ports where you know the purity of the water.

1. After verifying that the water supply is safe for drinking find the city water valve at aft transom. Remove the cap and inspect screen for debris.

2. Connect a water system approved garden hose to the city water valve. Turn on the water supply and check for leaks at the connection. White hoses are the ones normally rated for fresh water supply verses a regular garden hose which normally leave a rubber smell in the water supply.

2. Repeat steps 2 and 3 as indicated on the last column since the process at this point duplicates itself.

Note that the city water valve protects vessel water system by limiting incoming water pressure to 35 psi's.

Sanitizing Your Vessel Fresh Water System

It is recommended to sanitize your vessel fresh water system at least annually or more often when odors are detected.

1. Flush entire system thoroughly by allowing potable water to flow through it.
2. Drain system completely including water heater.
3. Fill entire system with a chlorine solution having a strength of at least 100 parts per million, and allow to stand for (1) hour. Shorter periods will require greater concentrations of chlorine solutions. See the table.
As a rule of thumb quick reference without the use of the table to reach the recommended proportions use a quarter cup of household bleach for every 15 gallons of water the fresh water tank holds.
4. Drain chlorine solution from entire system.
5. Flush entire system thoroughly with potable water.
6. Fill system with potable water at the deck water fitting.

TABLE 1 – CHLORINE CONCENTRATIONS

Amount of chlorine compound required for 100 ppm solution

Solution (Gallons)	Chlorinated Lime 25% (ounces)	High Test Calcium Hypochlorite 70% (ounces)	Liquid Sodium Hypochlorite 1% (quarts)
5	0.3	0.1	0.2
10	0.6	0.2	0.4
15	0.9	0.3	0.6
20	1.2	0.4	0.8
30	1.8	0.6	1.2
50	3.0	1.0	2.0
100	6.0	2.0	4.0

Winterizing Your Vessel Fresh Water System

Note that In freezing climates make sure the fresh water system is winterized to prevent damage to hoses and components. Contact your Regal dealer since only special alcohol based products like "Winter Ban" are to be used in the system.

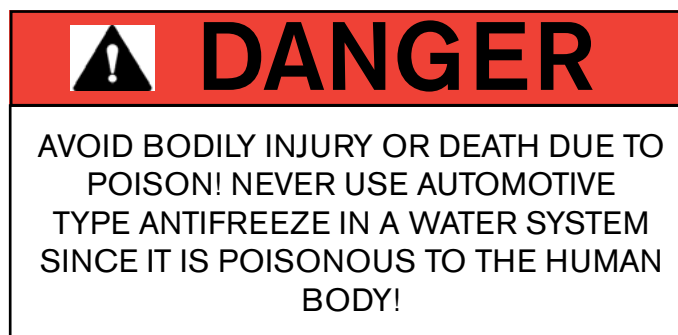

Fresh Water System-Helpful Hints

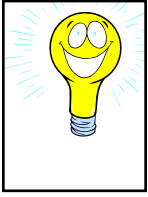

1. Fresh water pressure pump cycles on and off. Normally this type of action indicates a water leak in the system. Check all fresh water system related equipment on the deck, cabin, and engine compartment for leaks.

Do not forget wash down equipment including spigots. Look for puddled or dripping water.

2. Using potable water system the water pressure is weak. Check the fresh water pressure pump filter for debris. Also, make sure the potable water tank level is sufficient at the monitor panel.

3. Water at sink or shower is hammering and has air bubbles in it. Check for air leaks in the system along with low water levels in the potable water tank.

4. Water is backing up in the shower. Find the shower sump pump. If it is full of water even when running there may be a clog at the pump screen. Clean as needed.

5. There is no water at any of the fresh water related equipment such as faucets, showers and wash downs. Check to make sure the fresh water pressure pump breaker is activated. Also, check the fresh water monitor for tank levels.

6. The water system has a bad odor. Use the fresh water pressure pump to drain the fresh water system. Do not drink the water as it may be contaminated. Sanitize the water system.

7. No hot water. Check panel breaker. Check for popped tank element breaker. Reset as needed.

Hot Water Heater



HOT WATER FEED HOSE

TEMPERING VALVE

COLD WATER TO TANK

TEMPERING VALVE COLD WATER FEED HOSE

Overview

The ship's water heater requires 120 Volts AC and the unit is located in the sump (bilge). It is a cylindrical shaped unit. The water heater breaker is located on the main ship's AC panel. It offers a 4 gallon capacity. The unit draws cold water from the fresh water tank and is heated by using dock side power or by the generator at sea. *Note that the water heater does have a limited hot water capacity.*

Operation

The photo above displays key players in the operation cycle of the hot water heater.

The cold (blue) water line transports water from the fresh water tank to the aft tee on the water heater. Water runs through the tank via a tempering mechanism and exits the hot (red) line to the hot side of each sink and to the head shower mixing valve. *People on board need to be aware of that fact. It pays to conserve!*

The tempering valve is attached where the hot water exits the hot water heater for travel to the sinks and shower. You can identify the valve by the arrows on the knob on top. Make a note of the tempering valve setting and make sure it does not change. The purpose of the tempering valve is to regulate the outgoing heated water to a maximum of 125 degrees. If the output water is of a higher temperature than specified the valve mixes cold water to decrease outgoing warm water to safe levels through the stainless steel mesh hose.

There is an 750 watt element located inside the rear cover of the hot water heater. This is the component that heats up the water inside the water heater. The element requires that it be immersed in water.

The hot water heater features a 316 gauge stainless steel inner liner with two thermostats; a temperature thermostat and a safety thermostat designed to trip in the event the tank is run dry. Both thermostats can be reset. Furthermore, there is a safety valve for easy winterizing of the unit.

For more information refer to your water heater operator's manual.



WARNING

PREVENT INJURY OR DEATH
FROM ELECTRIC SHOCK!
NEVER REMOVE THE REAR COVER.
CALL A SERVICE PROFESSIONAL
AS HIGH VOLTAGE IS PRESENT.



CAUTION

PREVENT HOT WATER HEATER DAMAGE!
NEVER ACTIVATE THE BREAKER
WHEN THE HOT WATER HEATER
IS NOT COMPLETELY FULL OR
THE ELEMENT MAY BE DAMAGED!

Waste System (Typical)

Overview

This section covers the main components of the standard waste system. Note that your vessel may have other components that are not covered in this section. Refer to the vendor owner's manual located in the owner's information packet or consult the internet or your closest Regal dealer for details regarding optional equipment.

The main standard components of the waste system are the toilet, holding tank, monitor panel along with hoses, fasteners and sea cocks. We will explore each in this section.

Typical Head (Toilet) System

The onboard style head system features a vacuum toilet using minimal water. It normally features vitreous china bowls, minimal maintenance, easy cleaning and a wall switch keyboard.

The toilet is powered by 12 volt DC current and is controlled by a 30 amp breaker located at the ship's battery management panel.

Under normal conditions, the head system operates from the onboard freshwater tank. If dock side water is being used the toilets still draw water from the freshwater tank.

A Few Notations About Marine Toilets

Only human waste and toilet paper should be put in the toilet. Never flush foreign materials such as paper towels, pre-moistened wipes, condoms, feminine hygiene products, dental floss or household garbage down the toilet.

- Always disconnect the dock side water system if boat is left unattended to avoid property damage due to leakage.
- Refill the toilet as soon as possible after emptying the bowl to prevent objectionable odors.
- Use only RV-Marine toilet tissues that disintegrate rapidly. Do not use household type tissues.
- If repairs are needed, use only a trained and qualified marine technician or electrician.



Operating Vacuum Style Toilet

To use toilet first make sure the 12 volt breaker is activated at the main control panel. Remember even though you are using dock side water the heads draw water via the fresh water system through the potable water tank.



The wall control switch is used to add water to the bowl and to flush the toilet. Select cycle information is noted here. For more complete information, refer to the toilet vendor information located in the information packet.

1. To add water (est. 17 ounces each cycle) to the bowl press the add water button momentarily and release. The system prevents overfilling the bowl.

2. To flush the bowl press the flush button momentarily and release. The attached bowl motor will macerate the waste and flush it. The cycle ends with a small amount of water being added to the bowl to help prevent odors. This completes the minimal water usage flush cycle.

Wall Control Panel Blue Backlighting Description:

- The holding tank icon in the lower right hand corner of the control panel is not lighted. Toilet system is off or not receiving power.
- The holding tank icon is normally green. This means the holding tank is less than full.
- The holding tank icon is red. The holding tank is full or near full with the flush lockout (prevents Flush operation when holding tank is full) activated.
- Tank icon flashes.
- Sleep mode (non-use for 8 hours) causes the lights to go out. Pushing the fill or flush button momentarily will return lighting cycle.

Single Flush Override of Flush Lockout

1. If the holding tank is full the flush lockout cycle will not allow the bowl to be flushed and the flush button will be lighted red.
2. For emergency use only the flush button can be held for 8 seconds and a flush will occur. This can be accomplished because the full sensor connected to the holding tank is usually placed a bit below the actual full capacity of the tank. Flushing more than 5 times using the override feature may force waste into plumbing system. Regal is not responsible for damage to equipment, injury or death due to overflow of waste when the flush lockout is overridden.

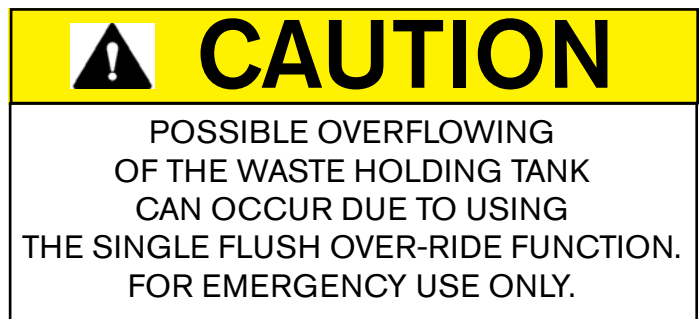

Head Shower Notes



The head features a separate shower with an acrylic door and teak highlights. Teak is known as a hard wood with the ability to resist water infiltration in the marine environment. There is towel storage above the shower and is protected by the overhead design. The mixer works similar to home components. Turn the handle to the left for warmer water and to the right for colder water. The shower head can be rotated as needed.

There is a tempering valve on the water heater to keep water temperature below 125 degrees. See the water heater information in chapter 4 and the technical chapter for further details.

Note that when showering the volume of the hot water heater is less than home water heaters; therefore it is recommended that water conservation measures be put in place.

Note that at sea the shower is using water from the potable water tank. At dock the tank is bypassed by connecting a hose to the city water valve to use marina water. Verify that the water is safe before attaching the hose.

The shower floor is covered with a teak grate. This enables water to drain out the drain and into the shower box where an automatic pump evacuates shower water.

To remove the grate simply pull up until it releases from the Velcro style fasteners. Periodically clean the drain screen of any accumulated debris. The grate can be rinsed with a garden hose and reattached at the shower floor.

Use a soft cloth and mild soap to clean the shower head walls. A squeegee can be used to clean the shower door sections. Rinse to remove residue.

An LED ceiling fixture provides additional light and is switched at the head wall.

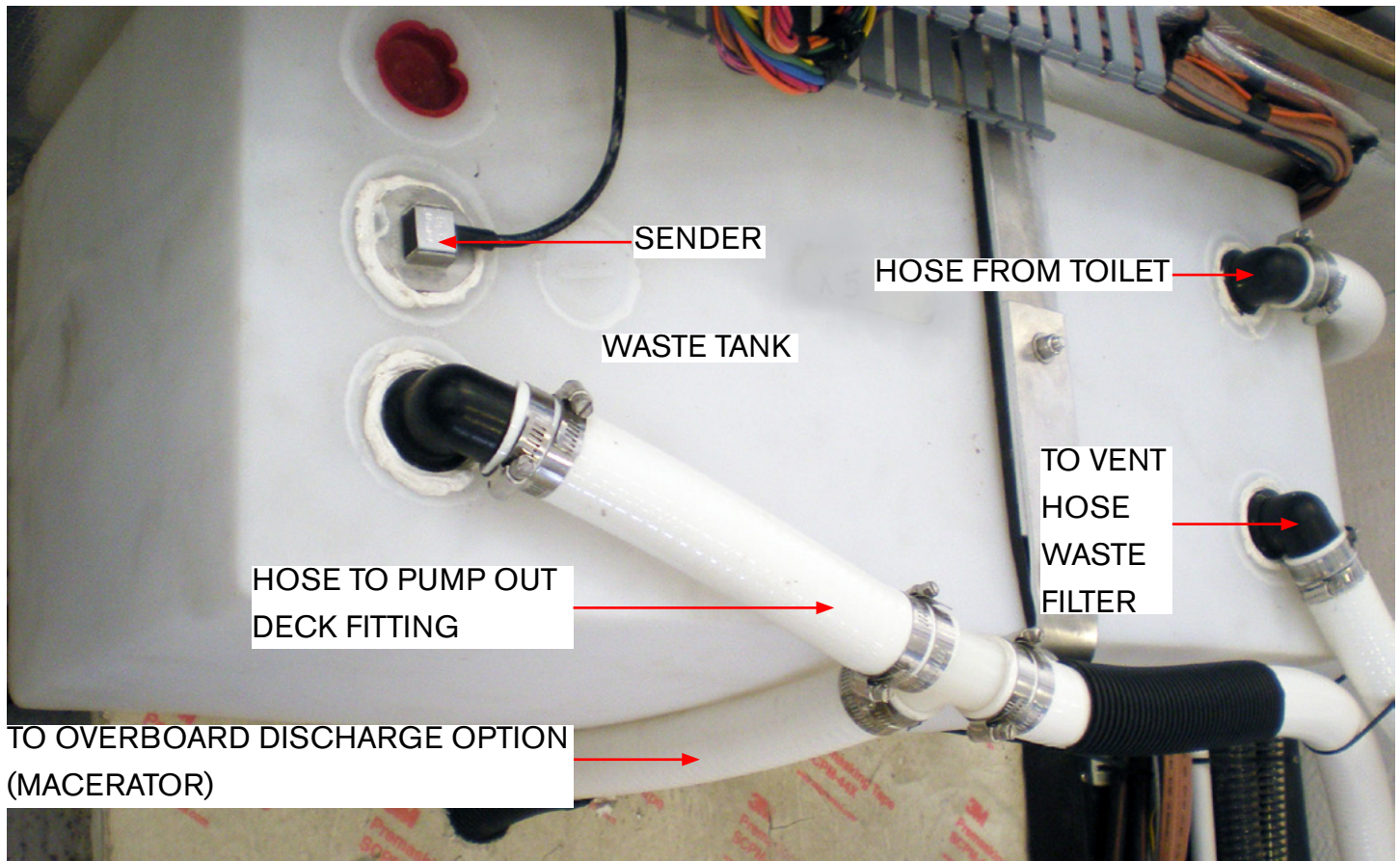

Monitoring the waste tank level is important as you need to schedule pump out procedures as the waste tank levels reach a near full capacity.

Always check levels before each cruise. There is a level sensor located in the waste tank. A signal travels through the Garmin chart plotter network extender (router) to the screen display.

If you go to the home display and then to vessel display you will be able to monitor all tank capacities including the waste. Follow instructions below. Touch right side of display and sweep your finger to the left which will bring up the display boxes. Choose AV/Gauges and next choose Vessels which will display tank levels including the waste tank.

Check the waste tank level on the chart plotter as the display should show empty after pumping.

Overview

The waste water system on your vessel is located in the sump. The system features a pump-out fitting mounted on the deck labeled waste.

The waste tank can be pumped out at select marine facilities. Normally a hose is attached to the deck waste fitting and the tank waste is then pumped into a dock side facility storage container.

After the pump out procedure it is always recommended to use a garden hose to rinse the pump out hose before securing the waste fitting. This will help keep residue and waste debris from building up in the inside of the waste hose.

Overboard Discharge

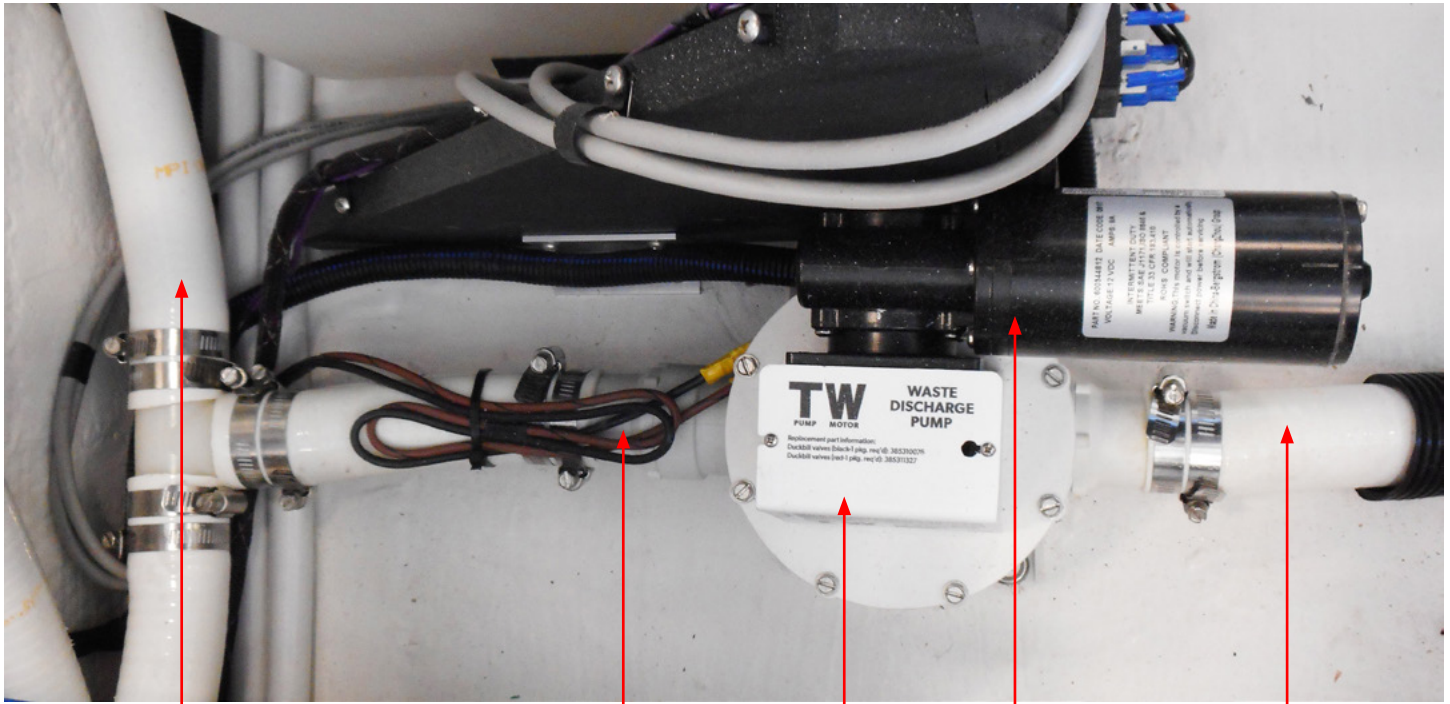

HOSE-TO DECK PUMP HOSE TO OVERBOARD MACERATOR HOSE TO SEA COCK
OUT FITTING DISCHARGE PUMP DISCHARGE PUMP

Macerator Operation

As an option the vessel may be outfitted with an overboard discharge system including macerator. Waste will exit the hull through the macerator sea cock turned to the open position.

Check for all local and state laws regarding pumping overboard domestically before attempting to open the hull bottom sea cock as there may be stiff fines for pumping illegally. It is legal to pump overboard outside the United States 3 mile limit.

Open the overboard discharge (macerator) sea cock before attempting to pump waste overboard. To pump overboard note that there is a key switch at the cabin main DC panel. Turn the key to the "on" position. Next, press the macerator button on the battery activation panel (under aft seat) and the macerator pump will exit the ground up waste through the hull bottom sea cock.

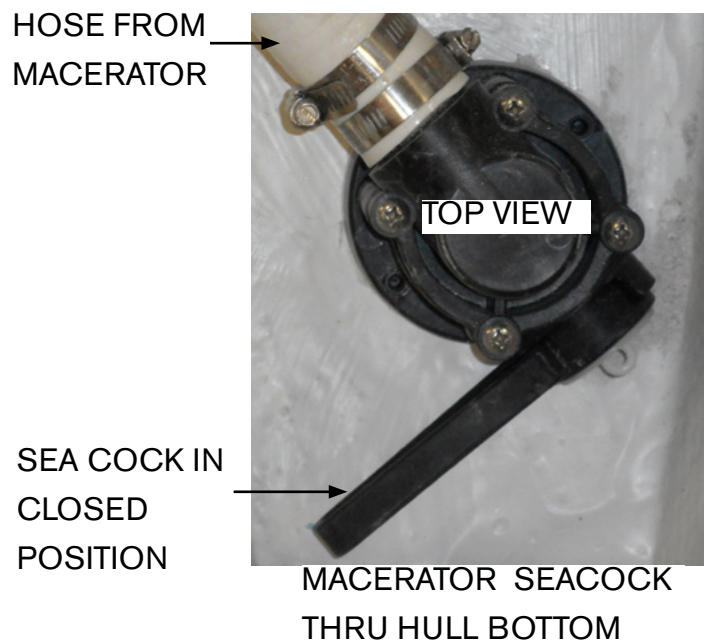



BATTERY ACTIVATION PANEL

The macerator breaker is 10 amps and is located at the DC distribution panel. After pumping out, the sea cock handle must be turned to the off position and tie wrapped closed.

Periodically check all waste tank hose clamps for tightness, hoses for cuts and abrasion and that all components are fastened securely. Check for leaks.

Vent Filter



The waste (holding) vent line tank filter is in-line between the holding tank vent and in this case a transom exit (exit hose missing here). As the holding tank fills up with waste it gives off odors. The vent filter controls odors while they travel out the aft portion of the transom. The filter uses the most efficient venturi design and refined charcoal to control waste odors. The waste filter is “customer friendly” as it is designed with a union at each end for quick changeability. The unions unscrew counter clockwise for serviceability. It is recommended to change the filter yearly, normally at the end of your boating season. Mark the change date on the filter or on your vessel maintenance calendar.

We recommend carrying an extra vent line waste filter onboard. For information on availability contact your closest Regal dealer or maine retail outlet.

Shower Box-Typical

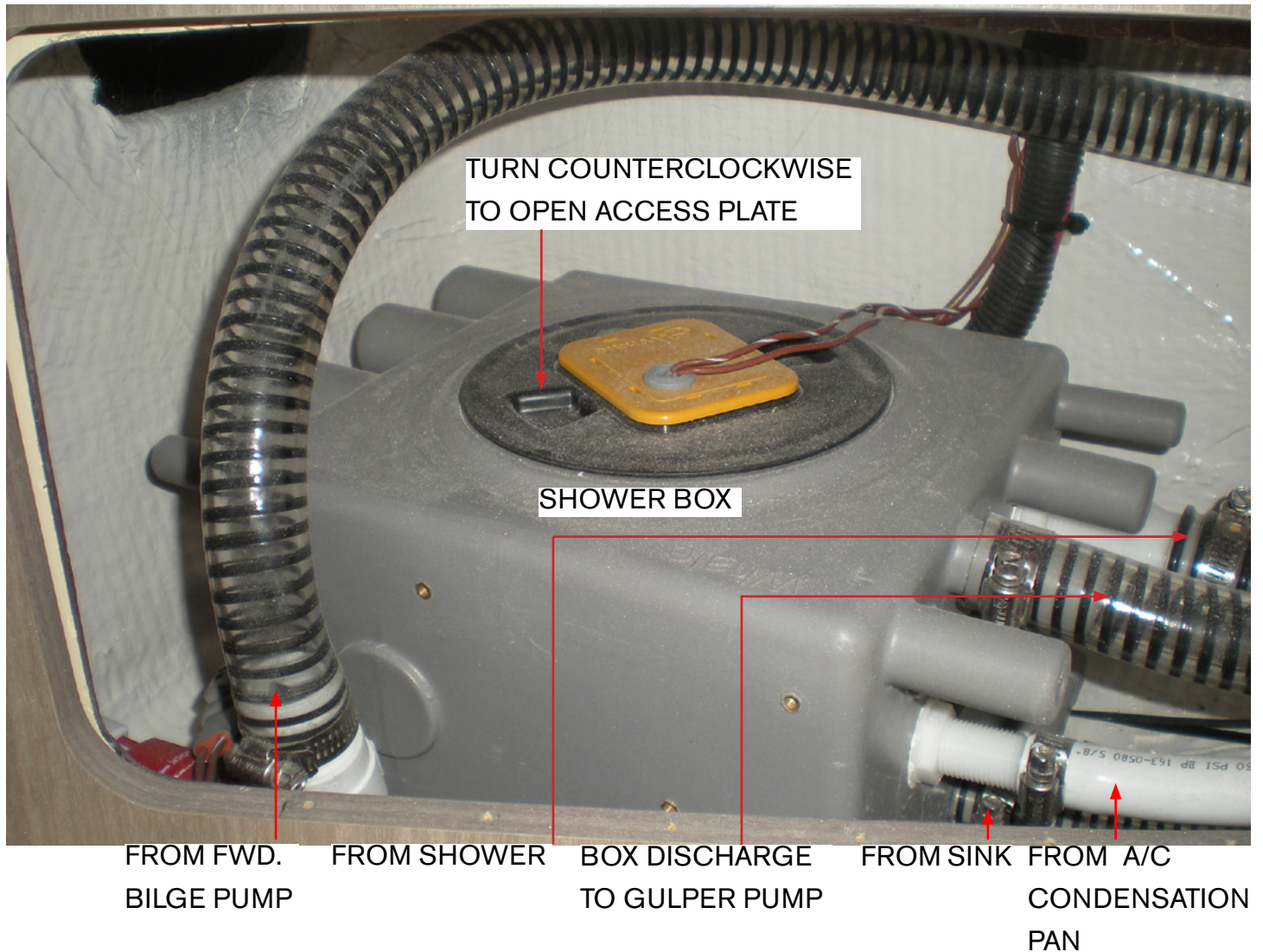

The shower pump box is a collection and distribution point for water used in the vessel's sinks, shower, A/C system, and bilge pumps. This used water is pumped overboard traveling from the shower box to a hull side fitting.

Periodically check the shower pump inside the shower box for debris buildup at pump grate. The round center cover can be turned counterclockwise and removed to access the internal shower box components.

CO Detectors

TYPICAL CO
DETECTOR



Carbon monoxide known as CO is indeed the silent killer. It is a by-product of combustion. CO is invisible, tasteless, odorless and is produced by all combustion engines, heating and cooking appliances.

The most common forms of CO on board vessels are petrol engines/generators and if applicable, propane heating and cooking devices. Note: Even though your vessels propulsion system is diesel based follow the CO precautions. Also, remember that a vessel moored next to you may be a CO poison contributor.

Never disconnect a carbon monoxide detector. Periodically test the device using the procedures defined in the CO operator's manual. Remember that a slight amount of CO in the human body over several hours causes headaches, nausea and symptoms close to food poisoning, motion sickness or flu. High concentrations can be fatal quickly.

How System Works

The CO detector uses a mini computer to measure and accumulate CO levels. Using the principle of "time weighted averaging" the detector monitors CO concentrations, temperature, humidity and time to calculate COHb levels. To explain COHb, our bodies prefer to absorb CO to oxygen and COHb is the absorbed ratio stated in a percent.

If the detector senses high levels of CO the alarm will sound in a few minutes. If lower levels are sensed, the detector will accumulate the data and sound an alarm when the appropriate level is reached. Read and understand the CO owner's manual in the information pouch.

The CO circuitry works to its best performance when continually activated plus it accords advanced warning when entering an area high in CO.

The CO detectors operate using 12 volt DC power and over current protection inside the battery management box in the engine compartment.

The test cycle should be activated frequently. Simply press the button. Refer to the CO detectors owner's manual for an explanation of the test cycle indicators.

Note that the green light will flash every 180 seconds which is normal.

When an alarm sounds take action immediately. The danger alarm indicator flashes red and the horn beeps 4 times, pauses and repeats the cycle. This indicates a rate of 10% COHb has been reached.

- a. Operate reset/silence button.
- b. Call your emergency services (911)
- c. Immediately move to fresh air. Do not re-enter the vessel. until emergency personnel have arrived, aired the vessel out and the alarm is in a normal condition.
- d. After following steps a-c and your alarm re-activates within a 24 hour period call a qualified technician to inspect the vessel. Note that the CO detector will clear when the CO concentration has dropped below 70 parts per million.

Fishing Systems (May be optional)

Bait Well/Live Well



The bait well sometimes referred to as a live well features a capacity of approximately 8 gallons. The bait well darker color decreases shadows on the tank walls which reduces bait stress. The design helps the bait to maneuver better inside the bait well prolonging bait life. The bait well switch for the pump is located at port side activation panel.



Constant sea water is supplied by an air control center featuring a bait well pump and drain which promotes a self-draining cycle to ensure constant water circulation and oxygen for the bait. A clear bait

well cover with latch and seal keep the bait and sea water contained while cruising to your fishing location. Also, the clear cover enhances monitoring. There is an aft sea cock that supplies sea water to the bait well through a 800 GPH pump located at the top of the sea cock. There is a manifold opening on the sea cock body that provides sea water for the port gunnel sea water wash down with nozzle. Notwithstanding the bait well includes an LED white light for night fishing use that is located at the cockpit port side activation panel.

Hints For Bait Well/Live Well Wellness

1. Never use soap or bleach to clean a bait well or live well. Use fresh water alone to avoid harmful residues.
2. For large delicate baits like menhaden, stick to one bait-per-gallon formula. Do not overload.
3. As much as possible, avoid handling baits with bare hands. Use a de-hooker or bait net instead.
4. If possible, always fill a bait well with water where the bait was caught.
5. During hot summer days use small sealed bags of ice in the well to help lower water temperatures without contaminating the water.

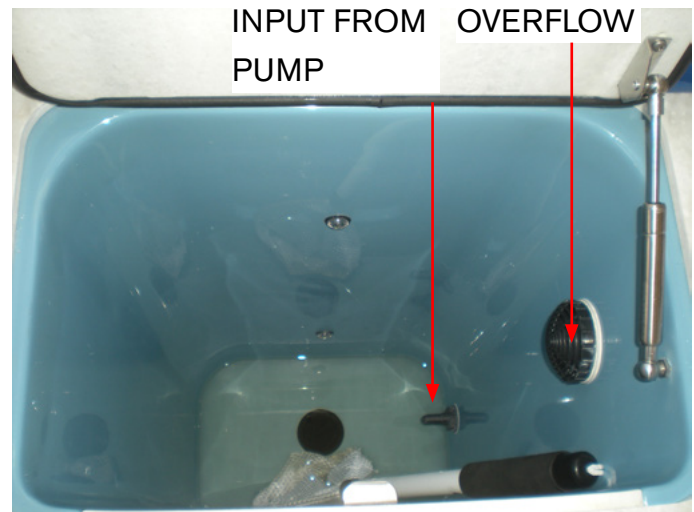

Insulated Floor Lockers

There are port and starboard 33 gallon insulated storage lockers integrated into the aft cockpit floor.



There is a pump switch located at the cockpit switch panel which makes these great to use as “catch of the day” containers. The pump system evacuates both lockers. The pump uses a Y to serve both lockers.

Floor lockers feature a hatch and a generous capacity for keeping the big catch for your return to port.

There is a vent near the top of each storage locker side that keeps a vacuum from forming with the hatch lid latched while the optional evacuation style macerator pump is energized. Do not cover the vent.

The storage locker evacuation utilizes a macerator style circulation pump installed in the aft sump (bilge) close to the battery set.

Following are tips on making the best use of your storage locker if used to keep your catch fresh.

Hints/Tips

Be sure to rinse out the storage locker before using fresh water. Do not use bleach or soaps.

Place ice in the locker. Pack down the ice several inches to provide a safety zone between the ice, catch and future melting ice (water). Close the lid. Note that the lid features a seal to keep the temperature inside the fish box cooler. As fish are caught layout in the cooler and quickly cover with a layer of ice. Layer fish and ice as other fish are added to the locker.



TYPICAL FLOOR STORAGE LOCKER

Rinse the unit with lots of water using the fresh water wash down at the gunnel (top hose).

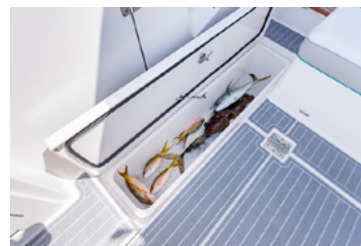

Periodically monitor the locker and remove any melted ice (water) using the pump. Do not let the water get to the level of the fish

as it will cause a spoilage process. Add ice to keep the catch well covered especially during the run to port. Avoid over opening the locker since this will melt the ice and raise the box temperature. Try to avoid rough handling or crushing the catch since bruised fish can alter the taste of the meat.

After the fish are removed from the locker the pump can be run to exit ice, fluids and fish debris from the unit.

The fresh or raw water wash down can be used as needed for the cockpit floor, live well or storage locker compartments for rinsing off debris.

Raw Water/Fresh Water Wash Downs

The raw water wash down silcock is inset at the port gunnel. Raw sea water runs through a seacock at the hull bottom and attached pump.

Note typical raw/fresh silcock below which features a 1/4 on and off valve.

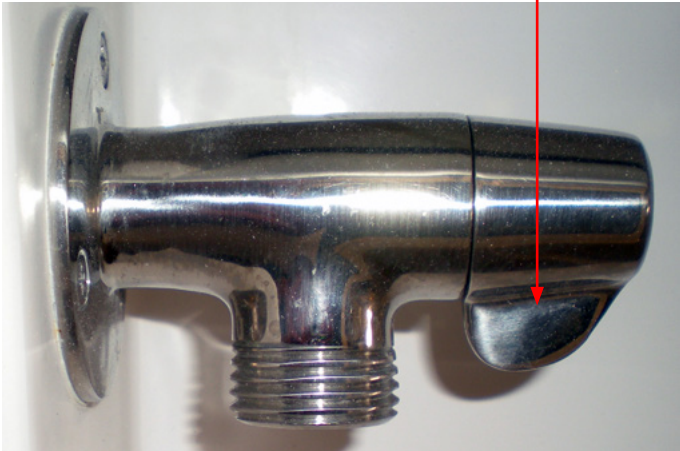

The fresh water wash down silcock is inset at the starboard gunnel. It uses the potable water tank (at sea) and the fresh water pump. There is a hose with a variable spray nozzle that can be attached to the silcock (faucet) for cockpit rinsing of floors and deck areas as needed.



The raw water wash down switch to energize the pump is located at the cockpit port activation panel.

Rod Holders



TYPICAL ROD HOLDERS



If installed, rod holders are located on the port and starboard gunnel and/or may be located on the transom.

The gunnel rod holders are 316 grade stainless for durability and heavy duty fishing. They can be used in conjunction with the optional Top Gun Outrigger system. The fishing rod sits at an aft angle in the rod holder while the outrigger controls the pole line, holds the bait and keeps the line out over the water while the boat is making headway. For trolling purposes the fishing rod handle rests down inside the rod holder. The gunnel rod holders also serve as cup holders.

If installed the transom mounted rod holders are useful for carrying a variety of fishing poles with different pound line and outfitted for catching specific fish. The transom rod holders provide a quick and easy way to change out the fishing gear.

“Grand Slam” Outriggers (Option)



TYPICAL OUTRIGGERS

Outriggers Overview

If installed on your vessel the 15' outriggers are used mainly for trolling. The twin outriggers accommodate individual fishing pole rigs on each side of the vessel.

Note that the outrigger nylon line must be attached between the outrigger pole eyelets, snap swivel and deck camel back, and bungee cord assembly with pulley. Once the vessel is making headway the fishing pole line is baited and attached to the outrigger clip hardware at the extension poles. Then the tensioning nut on the end of the outrigger is set. Once this is done with the fishing pole resting in the rod holder the fishing line is left to unwind while the outrigger is positioned and the line distance is achieved. At this point the correct drag adjustment can be set on the fishing pole reel. When a fish “strikes” the line is released from the outrigger clip and the fish is retrieved with the fishing pole.

If installed, refer to the outrigger information found in the owner's information satchel which will help keep your outriggers in top condition.

Typical Outriggers Collar/Handle Usage



Below is basic operation data for using and positioning the outriggers. For further detailed information refer to the vendor instructions in the owner's information packet.

Note that components can change at any time.

OUTRIGGER COLLAR LOCKED STORE POSITION



In the storage position the outriggers are positioned fore to aft on the hardtop with the handle and base collar as shown in A. The latch is in the locked position along with the swivel handle in the detent locked position. This is the recommended position for highway towing.

HANDLE/OUTRIGGER COLLAR UNLOCKED



B

In the swivel position the outriggers are positioned side to side (trolling position). To swivel the outriggers unlock the latch by swinging up 180 degrees as shown in B. Now turn the handle completely counterclockwise to release it from the detent position.

HANDLE/OUTRIGGER COLLAR/TROLL POSITION



C

While holding the handle in the released position, rotate the entire assembly until it stops in a detent. Tighten the handle. Lock the latch. See C. The outriggers should now be in the trolling position ready to attach the fishing pole baited line. Periodically inspect outriggers for missing or worn hardware. Replace as needed.

Chapter 5

Outboard Engine & Controls

Regal Owner's Manual



It is important that you read your outboard engine manual carefully and become completely familiar with the operation as well as necessary maintenance on the engine and propulsion systems. Pay careful attention to the sections on winterization if you live in freezing climates. Extensive damage can result if proper winter storage is not followed in freezing climates. Contact your Regal dealer for information regarding technical issues and parts. Also, refer to the maintenance section of this manual.

 **WARNING**

PREVENT INJURY OR DEATH!
READ ALL MANUFACTURER'S OUTBOARD
ENGINE AND PROPULSION OWNER'S
MANUALS BEFORE OPERATING
YOUR VESSEL.

This chapter is intended to give general information about the location and function of typical outboard engine and controls. Control systems and engines may vary from model to model. Refer to the specific engine owner's manual for your equipment that would include the following information in greater detail.

Engines function is based from four principles; fuel, compression, ignition, and exhaust. The proper ratio of fuel and air must be drawn into the engine's cylinders in order to be compressed by the pistons and ignited by a spark the force of which pushes the piston back down, providing the energy used to turn your propeller, before the engine kicks into the exhaust stage where it expels the by-products. If any of these four functions fail, so does the engine itself.

Beyond these basic concepts of engine functionality include engine cooling, lubrication, and electrical systems. The specific details of these systems can be found in the outboard manufacturer's owner's manual for the specific engine option you chose on your Regal boat.

Engine Removal

In the event the outboard engine needs to be removed from the transom consult your Regal dealer. He has the factory trained knowledge and equipment to remove the engine safely and efficiently.

Engine Checklist Before Each Outing

Every engine option may require different checks before each use, but a general engine checklist is included here as a guide.

- Check crankcase engine and gear case oil levels.
- Check steering fluid.
- Check power trim fluid.

At Helm/ Deck

- Check power trim for operation.
- Check control lever for operational defects. Check the clip and safety lanyard for functionality.
- Check gauges for accuracy.
- Check fuel level and ensure the level is sufficient for the trip with a reserve.

Engine Cooling System

Your typical engine normally utilizes a raw water system for cooling the engine with intakes at the gear case. It is important that this system continues to run unobstructed at all times to avoid hazardous situations and to ensure a safe voyage.

Raw water is drawn up into the outboard vertical drive shaft housing through pick-up feeds in the gear case vicinity.

Water passes through a power head thermostat which controls how much water circulates through the power head. The cool water absorbs heat produced by the engine, before being emitted via the coolant exhaust system.

There is a access hole on the port side of the power head which shows a visual stream of water at all times. If no water is visible with the engine running shut down the engine and investigate the problem. At times this relief hole can be plugged by debris.

Impeller/ Water Pump

Periodically, the coolant system's impeller and water pump should be inspected for debris, damage or excessive wear due to use, water chemistry such as mineral and/or silt conditions. Damaged parts will affect the system's ability to function, and may cause engine overheating or damage. Contact your closest Regal dealer for more information and maintenance schedules of key outboard engine systems.

Thermostat

If the temperature gauge starts yielding abnormal readings, it may become necessary to look at or replace the power head thermostat after determining whether it is functioning properly. The thermostat reads the temperature of coolant and determines whether to open or close a valve to allow warm sea water to pass into the exhaust manifold. The thermostat may recirculate hot coolant for the purposes of reaching standard operating temperatures.

If standard operating temperatures have been reached, the thermostat will open a valve and allow hot raw water to exit through the exhaust manifold. For more information read your outboard engine manual or contact the closest Regal dealer. Dealers have the necessary knowledge and tools to troubleshoot any engine related problems.

 WARNING
PREVENT INJURY DUE TO HOT SURFACE! AVOID TOUCHING THE THERMOSTAT OR ITS COMPONENTS WHILE THE ENGINE IS HOT.

 CAUTION
TO PREVENT ENGINE DAMAGE DUE TO OVERHEATING AVOID RUNNING THE ENGINE WITHOUT A FUNCTIONING THERMOSTAT.

Freshwater Flushing Attachment

Your outboard features a fresh water flushing system. After linking up to a fresh water hose at the flush port, water can be pumped through the engine's raw water cooling system to flush out all salt and debris that may be left behind. Normally there is a hose thread fitting on the side of the engine. After the connection is opened a garden hose is connected to the fitting and the engine can be flushed. It is best to connect the flushing system up when the engine is warm since the thermostat is open at this time to allow water to circulate through the entire head rather than bypassing the cylinder head areas. Do not run the engine while using the flushing device as engine damage may occur.

Engine Electrical System

Your engine utilizes a great deal of electronic equipment. Select equipment sends signals between the engine and the Garmin, while other systems set off alarms, and still others are used by the engine to generate a spark and ignite the fuel. The battery switch controls electrical power distribution to the boat systems.

To regularly maintain your DC electrical system, inspect the battery charge before each trip. Test all gauges and control equipment prior to departure, and replace as necessary. Spark plugs should be replaced according to your engine owner's manual maintenance schedule.

Gauge Electrical Signals

Your outboard transmits signals through electrical harnesses to different components through the use of NMEA 2000 connections and a "backbone system". A standard Garmin plotter displays the engine functions. Also, idiot lights are display tolerances that are classified as being abnormal.

Alarms

When a malfunction with your outboard engine occurs, the Garmin plotter alerts the skipper of a problem. Common engine problems include overheating, low oil pressure, or a miscommunication with equipment. Learn the alarm systems that apply to your engine by consulting your engine owner's manual.



CAUTION

AVOID ENGINE DAMAGE OR FAILURE!
DISCONTINUE ENGINE OPERATION
AFTER AN ALARM HAS SOUNDED.
ADDRESS MALFUNCTION BEFORE
RESTARTING ENGINE.

Spark Plugs

The spark plugs are the piece of equipment that help make ignition occur. As electrical potential builds on one side of the gap based upon the energy distributed by the distributor, the potential eventually grows large enough to cause the electric current to jump the gap on the spark plug. This spark is what ignites the compressed fuel generating a controlled explosion that will power the piston down and deliver power to the drive shaft.

Stator

Under normal circumstances, the starter battery would wear down after being used so often to generate a spark for the engine. This isn't an ideal setup because a strong battery is needed for continual operation. A weak battery does no good out on the water. The stator recharges the batteries while the engines are running.

However, in an effort to conserve battery life, the battery switch should still be turned off after every trip and turned on at the start of every trip. This limits the drain on the battery while the boat is not in use. As standard equipment a battery charging system charges batteries while the dock side cord is hooked up. It is a 40 amp charger.

Fuses

Your engine also comes equipped with fuses that will burn out or “blow” when engine components attempt to draw more power than the piece of equipment or wiring can handle. When the fuse blows, it breaks the circuit, and electricity stops flowing. Before replacing the fuse, investigate the cause of the problem, and why the equipment was overworked. Your outboard engine uses a helm mounted fuse box which is accessible by lifting the starboard bow backrest while others feature in-line fuses, while still others feature a mixture of both. Refer to your outboard engine owner's manual for complete details on your electrical system and the location of any engine mounted over current protection.

Engine Exhaust System

Your engine expels the by-products of the engine operation through an exhaust system, just like cars do. In boats however, this exhaust system mixes the debris left over after the power stroke of the engine with the hot water that is expelled after cooling the engine.

Basically the exhaust flows through the power head before expelling the exhaust through the vertical drive housing either just above the propeller, or through the prop shaft.

Engine Fuel System

Refer to the system chapter of this manual for fuel system specifics. Be sure to read and understand the following warnings.



WARNING

USE OF ALCOHOL ENHANCED FUEL, OR ANY FUEL OTHER THAN GASOLINE CAN LEAD TO DETERIORATION OF THE FUEL SYSTEM COMPONENTS. THIS CAN RESULT IN FIRE AND POSSIBLE EXPLOSION.



WARNING

GASOLINE VAPORS CAN EXPLODE! BEFORE STARTING ENGINE CHECK COMPARTMENTS AND MOTOR WELL FOR GASOLINE LEAKS OR VAPORS.



WARNING

PREVENT INJURY OR DEATH DUE TO FIRE OR EXPLOSION! RUN GENERATOR BLOWER AT LEAST 4 MINUTES BEFORE STARTING GENERATOR.

Engine Lubrication System

Whenever two components rub together, friction causes wear on both components. To minimize the wear on your engine, a lubrication system has been put in place to help components slide next to each other easier. This is particularly important within the inner workings of an engine. It is important to ensure your lubrication system is working properly at all times.

Your Regal utilizes lubrication and fluids that need regular check ups. Refer to your outboard engine owner's manual for specific details regarding the proper maintenance of the lubrication system.

Note that your outboard uses other lubricants in addition to engine oil such as power trim fluid and prop shaft gear case lubricants to reduce wear on moving components. These fluids should be checked according to the recommended maintenance procedures determined by the outboard manufacturer.

Engine Oil

The purpose of engine oil is to lubricate the internal components of the engine and ensure that parts that regularly move against each other have reduced friction to lessen wear and noise between components. An oil filter keeps metal particles and water out of the engine's interior.

Yamaha engines performing on regular oil should have the oil drained and replaced after the first 20 hours of operation or 3 months, and every 100 hours or at 1 year intervals thereafter.

Gear case Oil

Gear case oil keeps all the mechanical components of the prop shaft gear assembly functioning optimally. It reduces friction in the gear case as the gears revolve. Sometimes gear case oil is called gear lubricant. Gear case oil should be inspected periodically according to factory maintenance schedules. Use outboard manufacturer's recommended oil.

Power Trim Fluid

Power trim fluid allows your outboard to trim up or down. This is particularly useful when trying to get your boat to plane.

Power trim fluid is used in hydraulic rams that maneuver the outboard unit. Power trim fluid should be checked regularly in the reservoir which is located in the bilge.

Propeller System

Regal has carefully tested and chosen the propellers to give your outboard boat the best possible performance based on the engines and propulsion package you choose. We have allowed for the additional weight in equipment that might be added to the boat. It is recommended to carry a spare set of propellers and hand tools onboard in order to handle emergency propeller changes.

Each Yamaha propeller displays the following information:

1. Propeller pitch shown by inches.
2. Propeller type (L for left or R for right).
3. Propeller diameter in inches.

Your Regal features triple outboards. The port engine rotates counterclockwise and uses a left hand propeller. The center & starboard engine rotate clockwise (standard) and use a right hand propeller. Read and understand the label below.

 **WARNING**

AVOID A POSSIBLE ACCIDENT!
NEVER USE A STANDARD PROPELLER
ON A COUNTER ROTATION ENGINE, OR A
COUNTER ROTATION PROPELLER ON A
STANDARD ENGINE. THE VESSEL COULD
GO IN THE OPPOSITE DIRECTION EXPECTED
FOR EXAMPLE;
(REVERSE INSTEAD OF FORWARD)



LEFT HAND PROPELLER RIGHT HAND PROPELLER RIGHT HAND PROPELLER

Refer to the outboard manual for procedures, as the application is unique to the manufacturer. Call a marine professional or your Regal dealer to order a spare propeller set.

Propeller Checklist

At least twice a year, check the propeller for:

- Loose, missing, or corroded hardware.
- Nicks, dings, or missing propeller material
- Bent propeller blades.
- Objects wrapped around the prop (fish line)
- Decomposing propeller blades (electrolysis symptom).
- If equipped, check the propeller rubber hub for slippage

Contact a propeller shop or your closest Regal dealer if any of the above symptoms exist. They have purchased special equipment to refurbish both stainless steel and aluminum propellers.

Helm Systems

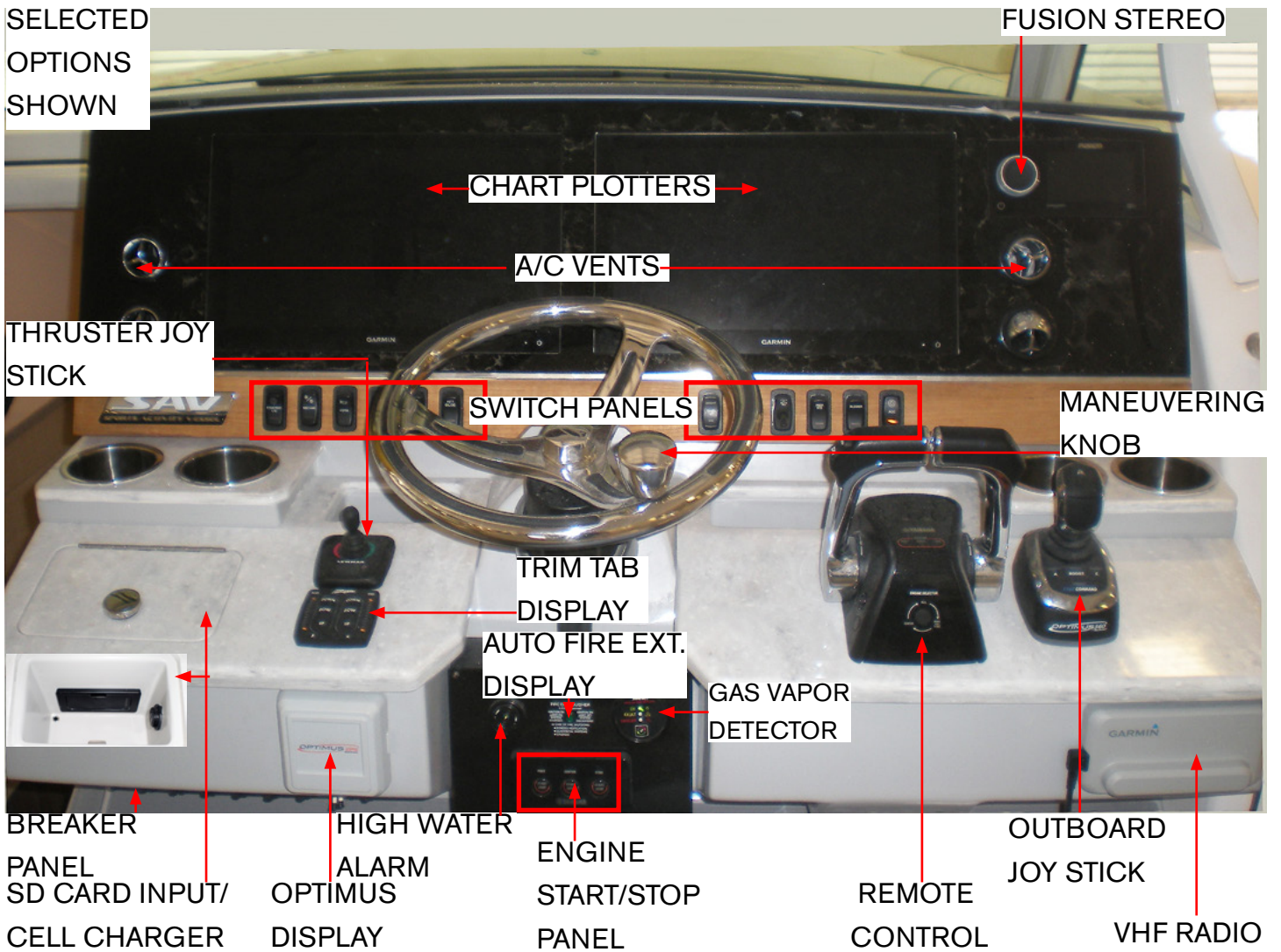

Helm Overview

The helm station is equipped with the ability to monitor engine functions through a Garmin chart plotter. Close observation of the digital display is recommended throughout the trip as you can split the screen to accommodate GPS functions along with monitoring basic engine systems including fuel usage and hours for maintenance cycles. This works in addition to the outboard engine manufacturer's alarm system.

Obviously with the dual chart plotter option another whole dimension of information monitoring is achievable. Note that with the battery switches at the battery activation panel in the "off" position, there is no power to the helm and the ignition switch will not function.

Select components are protected by the main DC distribution panel located in the cabin. Refer to the systems chapter for additional information.

Garmin Engine Monitoring Display



Typical Display Shown

A Garmin chartplotter is standard equipment on your outboard vessel. The unit displays many GPS features along with the ability to monitor engine system functions including tachometer; engine revolutions per minute (rpm's), GPS speed, voltage, fuel flow rate, trim, and temperature along with tracking engine hours. The image below features an alternative display on the Garmin touch screen focusing in on specific engine parameters.



Fusion uses its own display screen on the chartplotter for audio controls on the vessel.

Note that the Garmin and Fusion circuitry use individual DC sources to power up the system. The key switch does not power up these 2 systems.

1. To power up the Garmin plotter ensure the house main battery button is pressed on the battery activation panel. Then press the on button located at the upper chartplotter display.
2. The function AV/Gauges, Controls will appear as one of the choice boxes. Press the box. Another screen with engine will appear.
3. Press the engine box and the engine gauge displays will appear (oil pressure is engine code driven only).
4. The Garmin plotter provides setting up very personalized displays such as the Favorites one shown below. Refer to the Garmin owner's manual for further information.



Helm Switch Panel-Port



The port helm switch panel controls various vessel electrical components. Below is a brief description of each switch.

Note that select switches may represent optional equipment that is not installed on your vessel.

Courtesy Lts

This switch controls the blue LED lighting which is normally found on vertical surfaces to aid in nighttime cockpit activity. These types of illumination are especially useful to light stairways, deck walkways, and swim platforms.

Nav/Anc

This on/off/on switch energizes the center bow red/green navigation light and stern light as a standard configuration as the top portion of the switch is pressed. When the bottom portion of the switch is activated the anchor light all-around portion illuminates on the hard top. Check navigation lights before each outing to ensure the bulbs are working properly and the wiring circuitry is delivering current to the light fixture.

Horn

This momentary switch controls the electric horn at the hardtop. Make sure the horn is tested before each outing as it can be valuable in navigation situations and can be used for bridge communications. Normally there is an adjustment screw on the horn top to alter the horn tone. Periodically inspect the horn hardware for tightness and polish the horn trumpets as needed.

Windlass

This on and off switch supplies current to the windlass up and down switch mounted at the anchor rope locker. This switch also activates the windlass remote control.

Fwd. Bilge

This switch covers the forward bilge pump. This pump is located below the cabin steps under the floor hatch. It is close to the shower box. Periodically check the pump float mechanism to ensure it is activating properly and the pump grate for debris.

Aft Bilge

This switch controls the aft bilge pump which is located below the Lazarette compartment storage hatch in the aft cockpit.

Helm Switch Panel-Starboard



The port helm switch panel controls various vessel electrical components. Below is a brief description of each switch.

Note that select switches may represent optional equipment that is not installed on your vessel.

Panel Lt

This switch controls the helm switch panel brightness and dimming process for night time navigation.

Port Wiper/Stbd. Wiper

These switches control power to the port and starboard windshield wiper units as well as wash functions. Each switch features several intermittent delay intervals ranging from 3-18 seconds that control the wiper speed so you can set the wipers for most weather and water conditions.

Also, the switch features an LED night light indicator. There is a push-to-wash button on the top portion of the switch. It uses water from the potable water tank and features its own pump.

Fresh WTR

This switch energizes the on board potable fresh water system. It permits the water pump to draw fresh water from the potable water tank to any potable faucets, wash downs or showers mounted aboard along with the toilet. The gunnel mounted fresh water wash down is part of the fresh water system. This switch covers the use of the city water system when hooked up to the city water pressure valve dock side.

Blower

This switch controls the blower powered ventilation system. Before starting any type of engine perform a bilge sniff test for gas leaks. If negative then run the blower motor at least 4 minutes before starting an engine. Continue to run blower while the engine is running.



WARNING

GASOLINE VAPORS CAN EXPLODE!
BEFORE STARTING ENGINE(S)
OPERATE BLOWER AT LEAST 4 MINUTES
AND CHECK ENGINE COMPARTMENT
FOR GASOLINE LEAKS OR VAPORS.
RUN BLOWER BELOW CRUISING SPEED.

Acc

This switch controls any after market component that is added to the vessel. Always ensure that the amperage draw of the component is within the circuit amperage specifications.

Helm Components

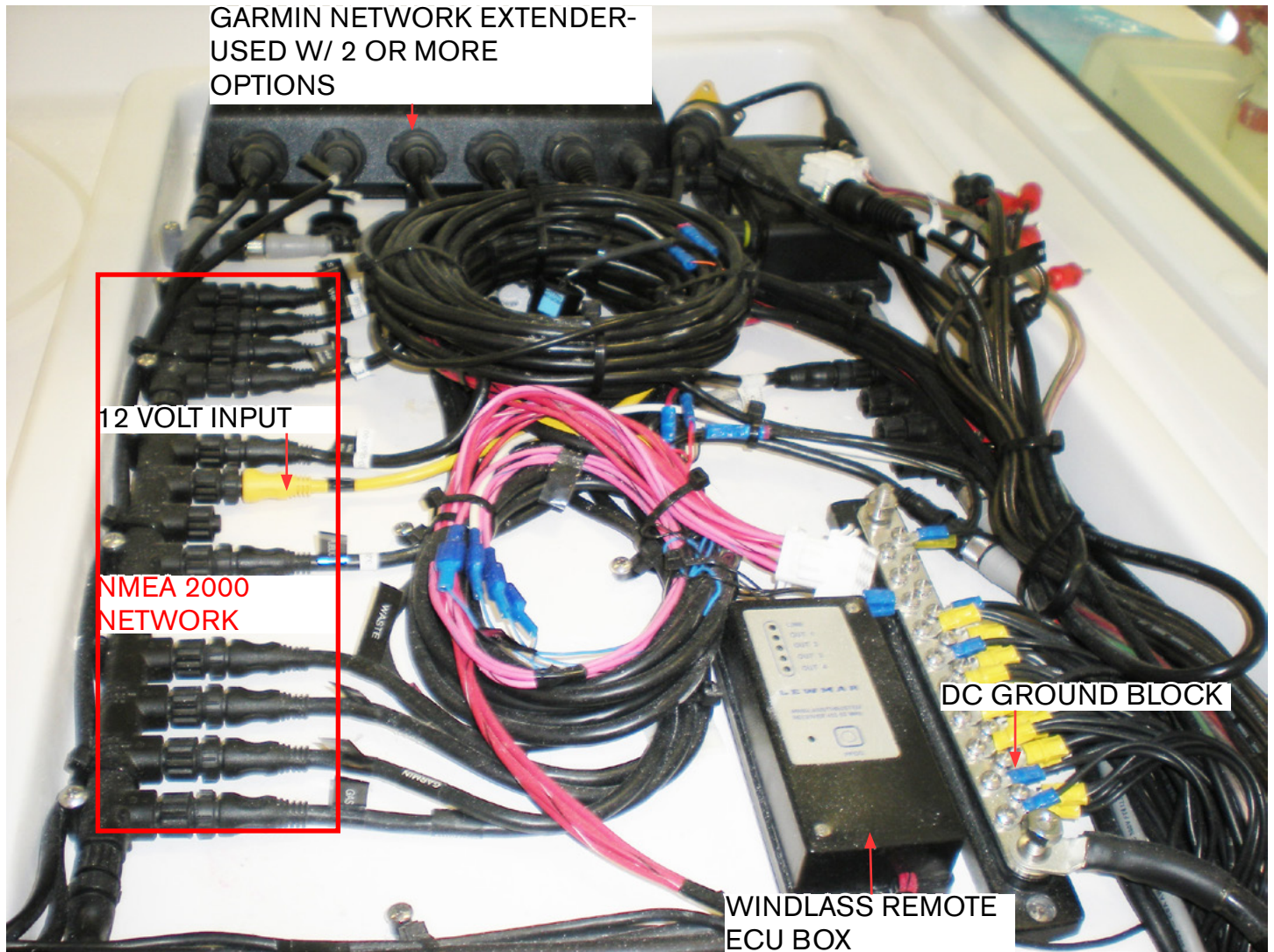

There are several major systems and related components housed behind the helm. To access for service first unplug the shore power cord from the vessel inlet plug. Then turn off all battery switches at the battery activation panel. Remove the screws holding the starboard Garmin plotter and components are now accessible.

ECU= Electronic Control Unit

Note drawings are available in the technical section of this manual which further define the wiring circuits and components.

Helm Breaker Panel

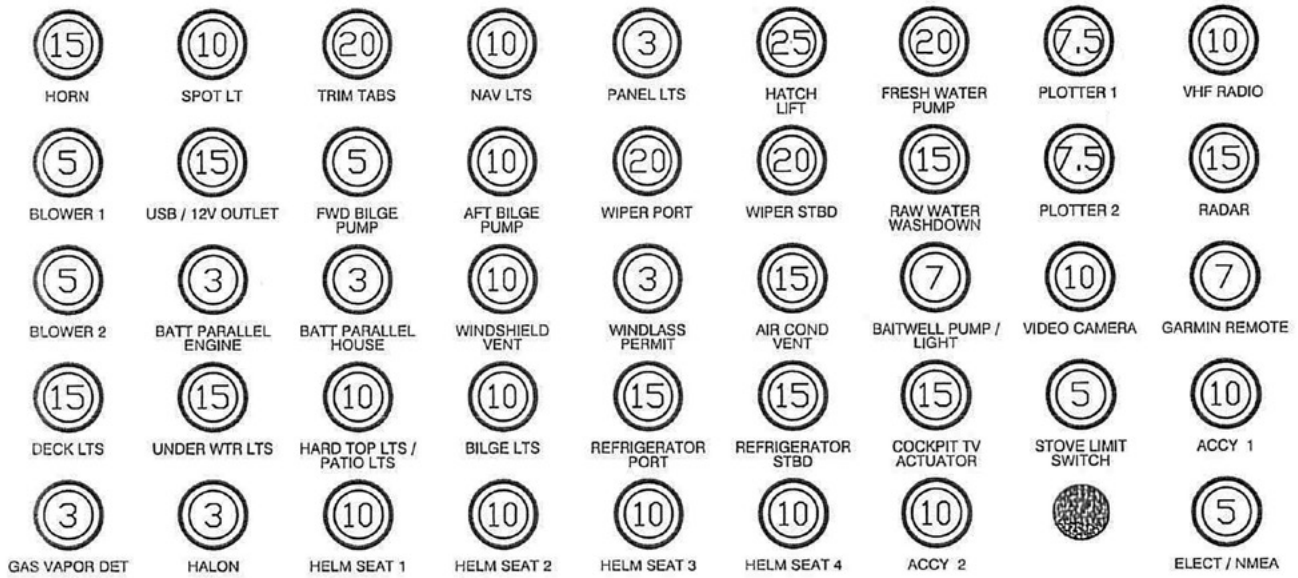

Note that select breakers protect optional equipment that may not be installed on your vessel.

Horn

This breaker protects horn located on the hardtop.

Spot Lt

This breaker protects the remote control spotlight

Trim Tabs

This breaker protects the trim tab motor located in the bilge compartment.

Nav Lts

This breaker protects the navigation light system.

Panel Lts

This breaker protects the helm switch panel lighting circuit,.

Hatch Lift

This breaker protects the hatch actuator motors in the bilge.

Fresh Water Pump

This breaker protects the potable fresh water pump located under the forward cabin floor locker.

Plotter 1

This breaker protects the helm mounted port Garmin plotter. Push on-Pull off style breaker.

Helm Breaker Panel (Continued)

VHF Radio

This breaker protects the helm mounted Garmin marine radio.

Blower 1

This breaker protects a powered ventilation blower motor.

USB/12 Volt Outlet

This breaker protects a number of phone charging stations and the 12 volt accessory plug.

FWD Bilge Pump

This breaker protects the forward cabin located bilge pump circuitry.

Aft Bilge Pump

This breaker protects the bilge pump located in the aft bilge.

Wiper Port

This breaker protects the port windshield wiper circuit.

Wiper Stbd.

This breaker protects the starboard windshield wiper circuit.

Raw Water Washdown

This breaker protects the raw water pump located in the bilge.

Plotter 2

This breaker protects the helm mounted stbd. Garmin plotter. Push on-Pull off style breaker.

Radar

This breaker protects the Garmin HD open array radar mounted on the hard top.

Blower 2

This breaker protects a powered ventilation blower motor.

Battery Parallel Engine

This breaker protects the engine battery parallel solenoid at the bilge battery switch board.

Battery Parallel House

This breaker protects the house battery parallel solenoid at the bilge battery switch board.

Windshield Vent

This breaker protects the windshield vent motor that opens and closes the vent.

Helm Breaker Panel (Continued)

Windlass Permit

This breaker protects the anchor windlass switch at the helm which actuates the circuit,

Air Cond Vent

This breaker protects the ventilation motor used to cool the helm area.

Bait Well Pump/Lt.

This breaker protects the cockpit bait well and inside lights.

Video Camera

This breaker protects the FLIR infrared camera system for nighttime navigation.

Garmin Remote

This breaker protects the Garmin master remote control.

Deck Lts

This breaker protects the deck courtesy lighting.

Under WTR Lts

This breaker protects the transom/hull mounted blue underwater lights.

Hardtop Lts/Patio Lts

This breaker protects the cockpit patio and hard top mounted lighting circuits.

Bilge Lts

This breaker protects the LED lighting in the engine room.

Refrigerator Port

This breaker protects a cockpit port mounted refrigerator circuit.

Refrigerator STBD

This breaker protects a cockpit starboard mounted refrigerator or ice maker circuit.

Cockpit TV Actuator

This breaker protects the TV actuator motor which raises and lowers the cockpit television.

Stove Limit Switch

This breaker protects the cockpit grill circuit which shuts down the power when the grill top is installed.

ACCY 1

This breaker protects after market components installed. Do not exceed breaker amperage limit.

Helm Breaker Panel (Continued)

Gas Vapor Detector

This breaker protects the gas vapor system circuitry.

Halon

This breaker protects the automatic fire extinguisher system helm mounted gauge circuitry.

Helm Seat 1- 4

These breakers each protect one of the four cockpit helm seats actuator switch circuitry.

ACCY 2

This breaker protects after market components installed. Do not exceed breaker amperage limit.

ELECT/NMEA

This breaker protects the electronics NMEA 2000 backbone circuitry.

Cockpit Systems- Switch Panels (DC)



Port Cockpit Switch Panel

Hardtop Lights

This switch activates the LED lights located on the hardtop.

Baitwell Pump

This switch activates the pump in the bilge to fill the baitwell.

Baitwell Light

This switch activates the LED lights located inside the baitwell.

Raw Water

This switch activates the raw water pump in the bilge. When activated sea water flows to the gunnel portside silcock (faucet).

Cockpit TV

The “up” switch activates the motor to close the cockpit TV in its locker.

The “down” switch activates the motor to open the locker and pivot the TV down for viewing.

Note that a blue ring indicates power to the switch but the component circuit is deactivated until the button is depressed. When you activate a switch (press button) it will turn red. Be sure to deactivate any switches before departing the vessel for extended periods.

Cockpit Systems- Switch Panels (Continued)



Starboard Cockpit Switch Panel

Patio Lights

This switch activates the LED patio light circuit in the cockpit.

Bilge Lights

This switch activates the LED bilge light circuit in the sump. They feature high lumens for greater visibility.

Underwater Lights

This switch activates the LED blue lights at the transom and hull side.

Fish Box

This switch activates the Gulper style pump drain the fish box.

Hatch Lift

The “up” switch activates the hatch actuator ram to open the huge Lazarette locker.

The “down” switch activates the hatch actuator ram to close the Lazarette storage locker.

Note that a blue ring indicates power to the switch but the component circuit is deactivated until the button is depressed. When you activate a switch (press button) it will turn red. Be sure to deactivate any switches before departing the vessel for extended periods.

Engine Starting/Stopping Controls



Helm Control Panel Overview



The following general information covers basic starting and stopping of your outboard engine(s). Read and understand all information on remote controls, fueling and operational procedures. Pay particular attention to all labels. Refer to the outboard engine owner's manual for further in-depth propulsion system starting information.

Yamaha Ignition Panel

Make sure each engine battery switch button is pressed at the battery activation panel. Pressing the switches at the activation panel supplies current to the Yamaha ignition panel. Start engine only in a well ventilated location to avoid CO buildup.

Locate the remote control handle in the neutral position. Advance the neutral throttle position as instructed in the engine owner's manual.

Note to connect the safety lanyard to a belt or secure piece of clothing. Ensure the lanyard is secured to the ignition panel post or the engine will crank but not start.

Periodically test the safety lanyard once the engine is started at the dock simply pull the lanyard from its latching mechanism and the engine will stop indicating the safety lanyard circuit is working properly.

Always keep passengers seated and children away from helm and remote controls.

Typical Start/Stop Panel

To start triple Yamaha outboards ensure the remote control is in the neutral idle position. Next, turn the key switch to the extreme right (ignition or “on” position) or the engine will not start. Press the start/stop button and you will hear the starter cranking over the engine. When started, release the button. Repeat procedure with the other buttons to start the other engines. You can start the engine in any pattern you desire.

To stop triple Yamaha outboards make sure the control is in the neutral idle position before attempting to shut down the engine(s). Always let the engines idle for a few minutes after a hard run. Then press and hold the start/stop button for each engine or turn the ignition key to the “off” position which will stop both engines.



CAUTION

AVOID ENGINE DAMAGE OR FAILURE!
CHECK THE ENGINE OIL LEVEL
BEFORE STARTING. IF LOW ADD
APPROPRIATE OIL TYPE AND QUANTITY.

Remote Control

Triple outboard vessels use a twin binnacle control for shifting and throttle operations. The remote control handles control forward, neutral, and reverse outboard shifting operations. When control handles are working together the port engine controls the center engine. The control handles can be used independently for maneuvering in tight quarters. When the control handles are not working together the center engine is in the neutral position. The control features power trim up and down functions. See the following information for component description and features. Read and understand the outboard motor manufacturer’s manual before attempting to operate the vessel remote control.

Practice docking operations using the remote control in a controlled environment to learn the basic control functions.

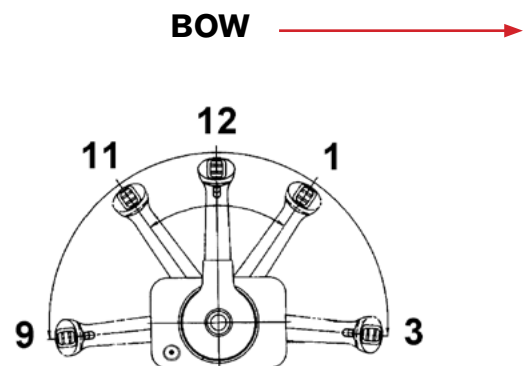

Profile Of Typical dual Engine Control Lever Showing Five Positions



Shown in the neutral position with idle throttle control. This is the detent neutral position for starting and stopping the engine(s). Pushing the detent button in and pushing the throttle handle forward will afford increased neutral rpm throttle advancement.



Pushing the throttle control lever forward from the neutral 12 o'clock position to the 1 o'clock position will engage forward gear with minimal throttle. From

the 1 o'clock position to the 3 o'clock position, the vessel is in forward gear with differing levels of throttle selections.



Pulling the throttle control lever back from the neutral 12 o'clock position to the 11 o'clock position will engage the reverse gear with minimal throttle. From

the 11 o'clock position to the 9 o'clock position, the vessel is in reverse gear with differing levels of throttle selections.

As you shift from neutral to forward or reverse, push the neutral release button, this allows the control lever to come out of the indented position.

The control lever features a *neutral safety switch* which ensures the outboard engine and control are in the indented neutral position for starting the engine. You will hear a distinct sound and see a blinking light and will feel the remote control's rotation lock in the detent position. Hint: If you turn the key and press the start/stop button and the engine starter doesn't crank the engine, ensure the control lever is in the neutral position.

Your control lever also features a trim control switch. This switch allows the captain to set the trim for the outboard drives from the helm either up or down to achieve a desired outboard running position.

Follow these points when shifting:

- DO NOT shift quickly from forward to reverse gear positions. Drive system damage may occur.
- DO NOT "pump" the throttle in neutral as it is normally not needed since today's engines use an enrichment valve system that requires very little starting throttle.
- DO NOT try to shift into forward or reverse gear at high rpm's. Personal injury, drive system, or property damage may result.
- Only use idle throttle positions when docking or maneuvering in tight quarters.
- Wear your safety lanyard at all times.
- Never shift the controls with the engine not running. Control, linkage, and/or outboard drive gear damage may occur.
- For more information, read your outboard engine manufacturer's manual before operating the remote control.

Safety Lanyard (Interrupter Switch)

The safety lanyard (found on the ignition panel) sometimes called an interrupter switch is attached to the operator and the ignition panel. Should the operator lose control of the vessel and become dislodged from his/her seat or fall overboard, the lanyard will shut the engine off. Make sure the lanyard is installed to a part of clothing such as a belt before operating the vessel.



WARNING

LANYARD MUST BE ATTACHED TO THE OPERATOR WHILE THE ENGINE IS RUNNING. A QUALIFIED OPERATOR MUST BE IN CONTROL AT ALL TIMES. READ AND UNDERSTAND THE OWNER'S MANUAL BEFORE OPERATING VESSEL.



WARNING

IF THE LANYARD IS IN THE "OFF" POSITION, THE ENGINE WILL CRANK OVER BUT WILL NOT START. ENSURE SAFETY LANYARD IS ATTACHED CORRECTLY AND SWITCHED TO THE RUN POSITION ON THE IGNITION PANEL.



WARNING

AVOID INJURY OR DEATH RESULTING FROM LOSS OF CONTROL!
NEVER LEAVE THE HELM
WHEN THE ENGINES ARE RUNNING!
KEEP EVERYONE SEATED WITH LIFE VESTS ON WHILE VESSEL IS UNDERWAY!

Engine Power Steering

Your outboard boat features as standard equipment an electronic helm "power steering" system. We will briefly describe the system and display various parts and their function. Overall this system lends itself to multiple outboard installations well with an effortless "power steering" feel. In addition, this system features light friction at low speed and higher friction at higher speed to provide a higher degree of maneuverability. Furthermore, it can be programmed for toe-in and toe-out settings which provide optimum vessel performance.

The starboard engine steering controls the center engine and work as one unit in a steering mode using the starboard power steering pump. The port engine uses the port power steering pump.

The hardware at both the helm and engine must be checked regularly for tightness, lubrication, and leaks. Check the steering system for full steering to port and starboard before disembarking.

The main system components are the electronic helm, electrical connection board, hydraulic steering pump and "smart cylinder". Note the adjacent drawing which shows normal system components. For service contact your closest authorized Regal dealer.

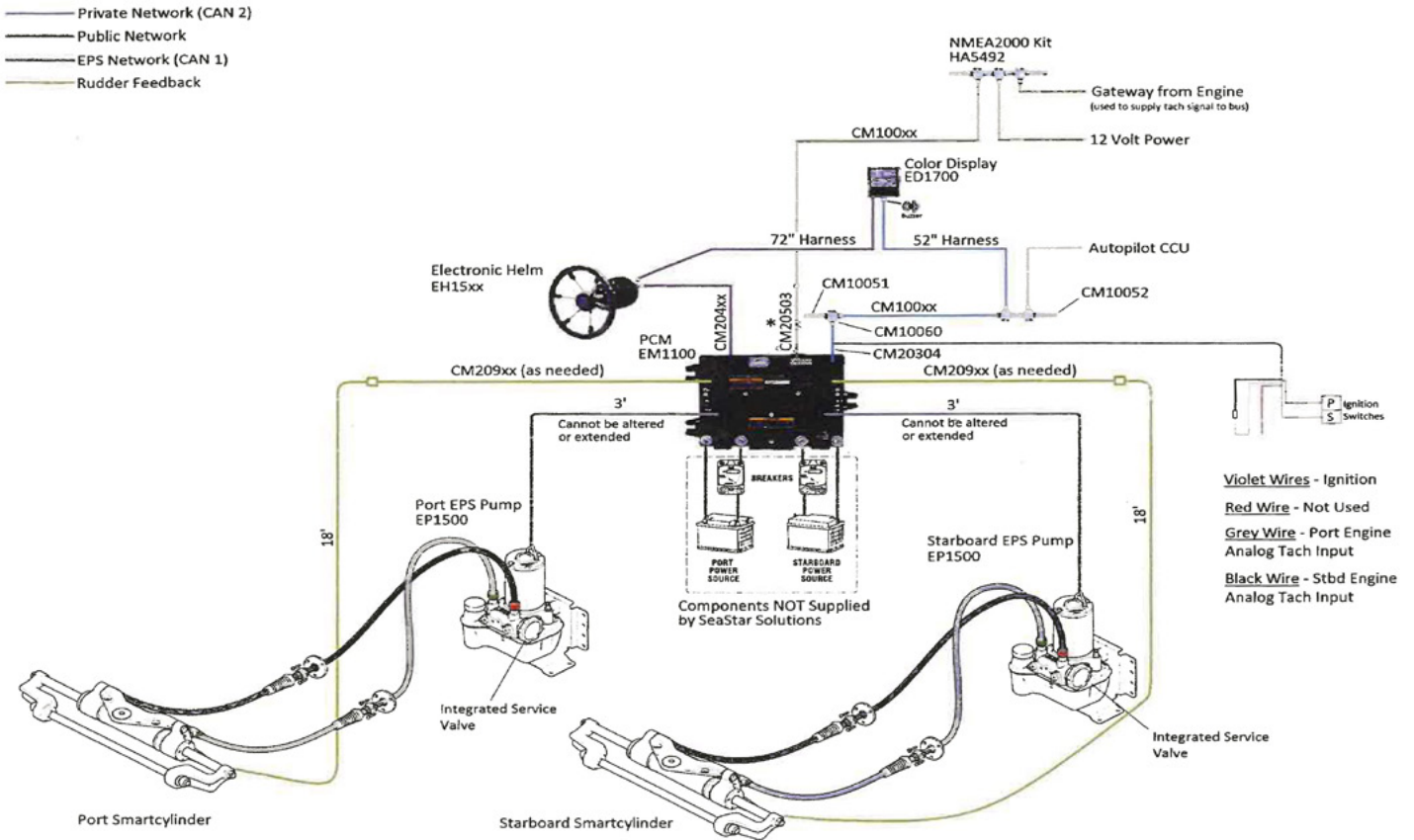

Electronic Helm

The electronic helm features a sport steering wheel and several tilt positions for maximum control taking into account individual driver needs and body types. The steering wheel motion can be adjusted to various lock to lock turning positions, along with the ability to adjust wheel friction tension through the cruising rpm range to afford the greatest driver control and feel at the helm.

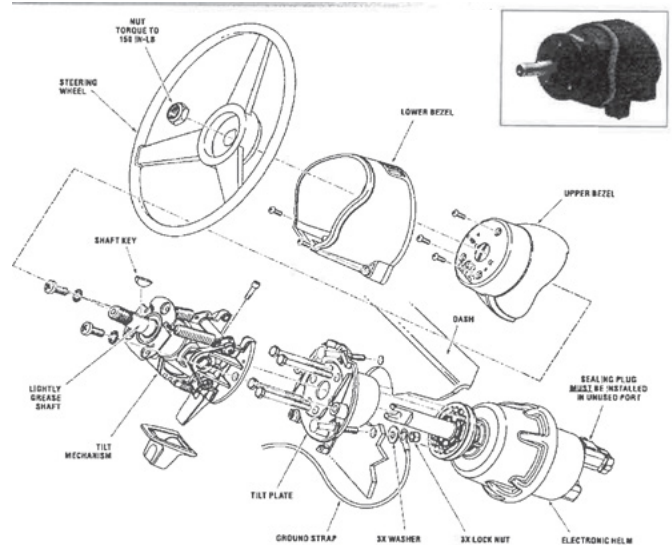

Power Steering Wiring

The electronic power steering is an on demand system using minimal power. The system uses two 60 amp breakers (one per starting battery) located near the battery source. The breakers are between each battery (twins) and the PCM mounting board. The illustration below shows a typical twin engine steering setup.

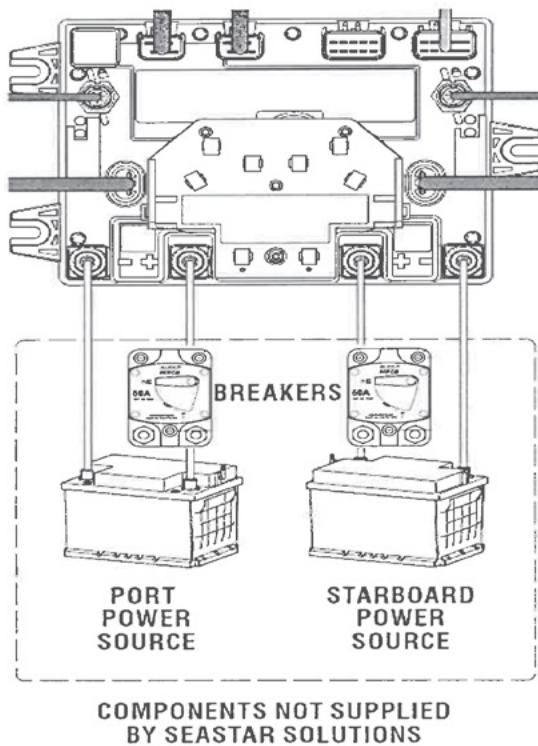

Hydraulic Steering Pump



Located under the aft center cockpit storage compartment is the steering system hydraulic pump system. Each pump controls the port or starboard steering cylinder. The Optimus steering system uses the HA5482 EPS power steering fluid. Do not use any substitutions. It is a good idea to have extra fluid, funnel and cloth on board for emergency filling of the system. Also, note that there is a service valve located on each pump. It allows for manual realignment of the engines during service or a system fault. Use the decal information as needed for manual realignment situations. Engine(s) must not be running while performing these realignment procedures.

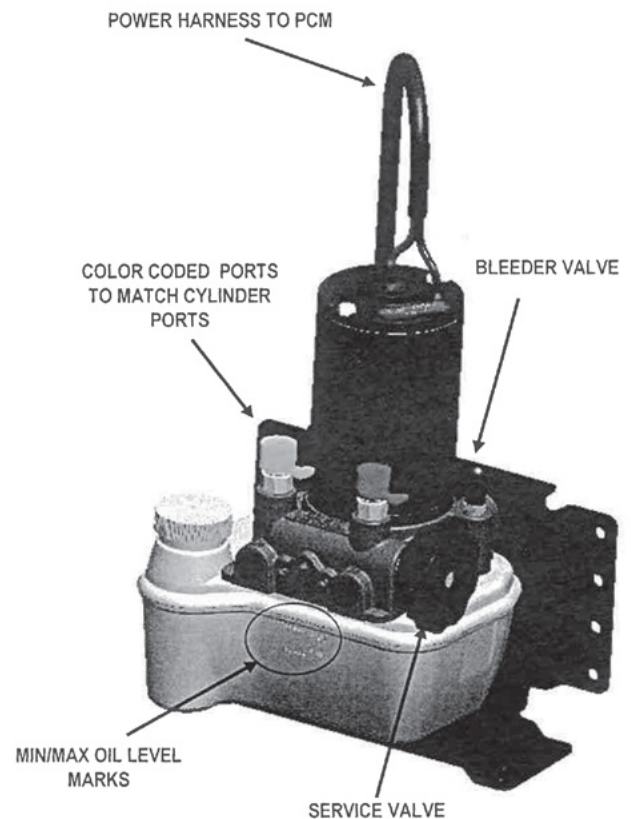

Smart Cylinder

Located on the engine front is the steering smart cylinder. It is foot printed with redundant sensors to determine the steering response to the wheel movement. If one sensor should fail there are back-up ones on each cylinder. The stainless steel cylinder includes ORB fittings with bleeders to purge air as needed.



Smart Cylinder Description

For information purposes components used in the smart cylinder are shown in the drawing. This illustration may be useful too for ordering needed parts as well as a troubleshooting breakout. Contact your closest Regal dealer to order parts.

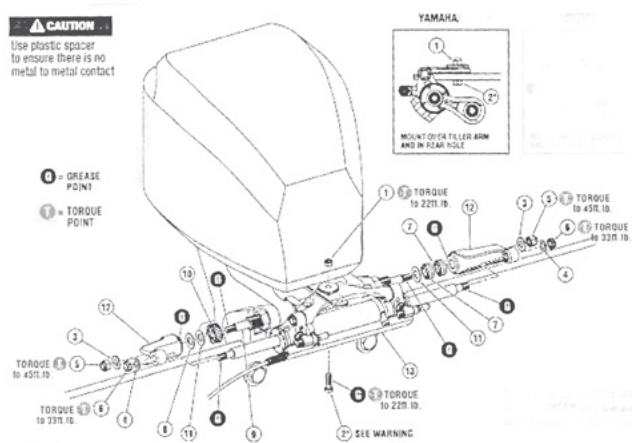

Figure 2-11

ITEM	PART #	QTY	DESCRIPTION
*1	112529	1	Nut, 3/8" NF Nylok® SS
*2	113225	1	HHCS 3/8" UNJFX 1.35 HSS
3	731625	2	Washer, Flat, 7/16" SS
*4	731720	2	Nut, 7/16" NF Nylok® SS
5	202027	2	Washer, Flat, 1/2" SS
*6	192126	2	Nut, 1/2" NF Nylok® NI Plate Br
7	995876	2	Spacer, Thick
8	996689	1	Spacer, Thin

ITEM	PART #	QTY	DESCRIPTION
9	730229	1	Support Rod
10	828085	1	Adjusting Nut & Screw, SS, Teflon Coated
11	202300	2	Washer, Flat, 5/8" SS
12	839120	2	Support Brackets
13	907099	1	SmartCylinder (EC5310) or 907033 SmartCylinder (EC5340)
14	728994	1	Spacer, Medium (scrw 1955 to 1998)
15	113350	1	HHCS 3/8" NF x 1-1/2" SS

Chapter 6

Vessel Operation

Getting Underway

Pre-departure Questionnaire

- Have all fluid levels been topped off?
- Is the fuel tank full?
- Is all safety equipment accounted for and easily accessible?
- Are navigation lights and horn operating properly?
- Is the bilge free of water and does the bilge pump operate?
- Is the outboard engine and propeller in good working condition?
- Is the drain plug in place ?
- Have all passengers been briefed on emergency procedures and seated for departure? Is the boat load balanced?
- Is the operator sober, alert and ready to skipper the vessel?
- Have all passengers been fitted for life jackets?
- Has a float plan been filed and left with a component person?

- Has the bilge been sniffed and the fuel system leak checked?
- Are sea cocks open (if applicable)?
- Is all communication equipment in good operating condition?
- Has a second person been briefed on operational procedures should the skipper become disabled?
- Are all gauges and electrical switches functioning properly?
- Has weather information been gathered and analyzed?

Underway Questionnaire

- After casting off have all dock lines and fenders been stowed?
- Are all passengers seated and all doors closed and latched?
- As skipper are you monitoring the dash gauges and/or Garmin plotter for changes?
- As skipper are you on the lookout for changing weather?
- Is the remote control safety lanyard tightly secured to your belt or clothing?

Disembarking Questionnaire

Have you removed the keys from the ignition and secured them?

- Have all systems been checked for leaks?
- Has the battery switch been turned to the “off” position?
- Are all sea cocks closed (if applicable)?
- Has the fuel tank been filled enough to prevent condensation?
- Is the vessel properly tied and covered with equipment stored?

Fueling

**DANGER**

AVOID SERIOUS INJURY OR DEATH!
GASOLINE IS HIGHLY FLAMMABLE
AND EXPLOSIVE MATERIAL.
PRACTICE “NO SMOKING” AND EXTINGUISH
ALL FLAMMABLE MATERIALS
WITHIN 75 FEET
OF THE FUEL DOCK

**WARNING**

AVOID INJURY OR DEATH FROM FIRE
OR EXPLOSION
RESULTING FROM LEAKING FUEL!
INSPECT ENTIRE FUEL SYSTEM AT
LEAST ONCE PER YEAR.

**WARNING**

SINCE GASOLINE IS AVAILABLE
IN SEVERAL GRADES
INCLUDING ETHANOL AND VARIOUS OCTANE
LEVELS, REFER TO THE OUTBOARD ENGINE
MANUFACTURER'S OWNER'S MANUAL FOR THE
CORRECT GAS TYPE/GRADE.
USING THE IMPROPER OCTANE LEVEL
OR THE WRONG GASOLINE TYPE CAN CAUSE
ENGINE DAMAGE AND VOID THE WARRANTY!

Before Fueling

- Make sure a working fire extinguisher is available.
- Stop engines and any device that can cause a spark.
- Disembark all passengers and crew not needed for fueling.
- Fuel if possible during the daylight hours.
- Check to ensure nobody is smoking in the boat or near the fueling dock.
- Close all portholes, hatches and doors to keep vapors from blowing aboard and settling in the bilge.
- Tie up your boat securely at the fuel dock.
- Identify the fuel fill. Unfortunately, people have mistakenly filled the water or waste with fuel.
- Visually inspect all fuel system components before each filling.
- Avoid using fuels with E-15 alcohol additives. It can attack fuel system parts along with hoses and cause deterioration.

During Fueling

- Keep the fuel nozzle in contact with the fuel fill to guard against static sparks. The fuel fill pipe is grounded through the fuel system wiring to protect against static electricity.
- Avoid overfilling the fuel tank. Leave room for expansion. Also, if fuel exits the fuel vent indicating the tank is full, this situation is dangerous and unfriendly to the environment.
- Avoid spilling any fuel. Clean up any fuel accidentally spilled with a clean rag and dispose of it on shore.

After Fueling

- Close all fuel fill openings tightly. Use a fuel key if needed.
- Open all portholes, hatches and doors if applicable.
- Sniff in the bilge and engine area for gas fumes. If fumes are detected continue to let the area ventilate until the odor is gone. Look for any traces of fuel droplets or spillage. Do not start the engine(s), smoke or run any electrical components until the fumes can no longer be detected.

Dock Line Basics

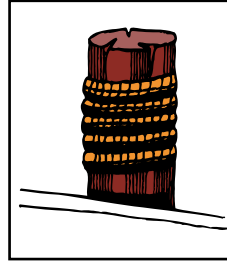

Most skippers use dock line terminology fairly loose but there is more to the basics than just bow or stern lines. There are several lines that can be secured to the bow and stern and depending on their direction and use, can be called other names. Remember that “forward” and “aft” refer to the direction that a spring line runs from the vessel, and not where it is secured on board.

Bow/Stern Lines

There is only one true bow line. It is secured to the forward cleat and run forward along the dock to prevent the vessel from moving to the stern. The stern line leads from a rear cleat to a piling or cleat on the dock astern of the vessel. This line keeps the boat from moving ahead. For small vessels these are the only lines needed for normal wind and current conditions. If located in a tidal environment, keep slack in the lines.

Breast Lines

These lines are attached to the bow and stern that lead to nearly right angles from the center of the vessel to the dock. They help keep larger vessels from moving away from the dock, or are pulled in to help people board the vessel. Larger vessels may use bow or quarter breast lines.

Spring Lines

Most small boats use two spring lines although it is possible to have four. They are called the after bow spring and forward quarter spring.

Bow springs are secured at the vessels bow area.

Forward spring lines lead forward from the boat to the dock and control movement toward the stern. After springs stem aft from the vessel, and stop movement ahead. Spring lines are used to prevent movement in a berth, ahead or astern. They are really useful in controlling the effects of a real active tidal surge. Spring lines are useful where fenders need to be kept in place against piles.

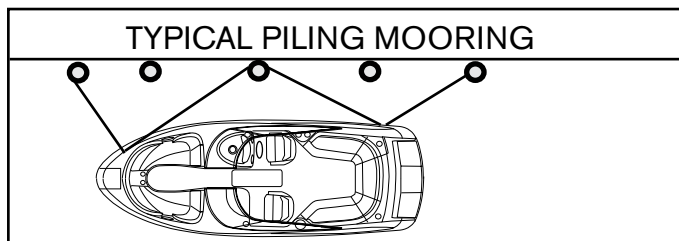
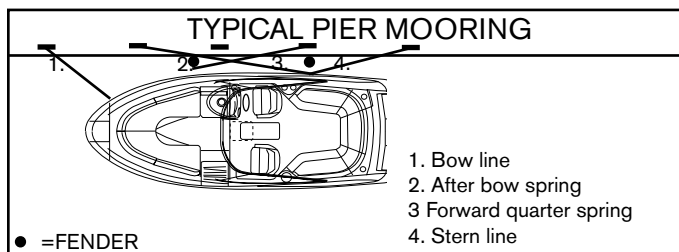

Boat Mooring

Most boats can be secured to a dock using four lines. The after bow spring is crossed with the forward quarter spring and secured to individual dock cleats or pilings. This ensures longer springs and can be snugged up tighter for more efficient tidal control.

Remember, if you only have one piling available, position the vessel so this point is opposite amidships. Run both spring lines to it. These lines will be shorter but still useful. The bow and stern lines should be relatively at a 45 degree angle with the dock. The stern line can be attached to the near-shore quarter cleat, but will work more efficiently to the offshore quarter cleat. The longer line will allow the boat flow with the tide with less time checking the vessel.

Dock Line Sizing

Most dock lines today are made of nylon, either of twisted rope or braided core and cover. The most often used material is nylon because of its stretching abilities absorbing shock loads. It is chafe resistant for extended life and is easier on bare hands.

The line's size varies with the vessel. Normally, a vessel in the 20' to 40' boats will use 1/2" diameter nylon lines. Larger yachts use 5/8" and 3/4" diameter nylon lines. Smaller boats can use 3/8" nylon lines.

Dock lines need to have the strength to hold the vessel and have enough density to resist chafing. They shouldn't be too heavy that they lose their shock-absorbing capabilities. Use the right size line for the vessel since a line too large for the boat will pull hard against the vessel since it won't be forced to stretch. If the line is too small for the vessel, there is no margin for wear and chafe when under strain.

Securing Dock Lines

When mooring your boat, make sure the dock lines are secured at both ends. Depending on your situation you may need to loop the eye splice of the dock line around a piling.

Sometimes the mooring line will lead down sharply from the piling to the deck cleat. Loop the eye splice around the piling twice to keep it from being pulled up off the pile.

Pull the line through the looped eye if the mooring line is too small to go around the piling twice or too small to fit over once.

If you must drop a line over a piling that already holds another boat's line, run the eye of the line up through the first eye from below, then loop it over the pile. This will allow either line to be removed without disturbing the other. If another line is dropped over yours, simply reverse the process. Secure a little slack in the other dock line, then slip your eye up through its loop and over the top of the pile. Your line can be dropped through the other eye.

When debarking from a dock, it is easier to release the line from a cleat or piling, from on board the boat, as soon as you leave the dock. Loop a long line around the cleat or pier and leading both ends on board you can release the line easily. Slip one end around the cleat or pile, then pull it back on board. Release the line without the eye splice, so it will run freely from around the pile without hanging up on the splice.

Fenders

Fenders are normally made of a rubberized plastic and are usually filled with air. Most have a fitting like a basketball so they can be inflated or deflated. Fenders are available in a wide range of sizes and shapes to fit both small and large vessels. Fenders are normally designated in inches. They are used between piers, docks, sea walls and the boat.

They protect the top sides of the boat from rubbing against rough objects. Most fenders have eyes of attachment which allow a line to be inserted vertically or horizontally. This will permit the fender to be tied off to fit a variety of marina, dock and tidal situations. Be sure the fender is correct for the vessel size. It is a good idea to carry extra fenders but half a dozen is normally an acceptable number. Remember to store fenders on board so they can be easily accessed. Some people incorrectly call fenders "bumpers".

Note that optional fender clips are available for your vessel.



There is a variety of fender styles and types, each selected for specified uses. When choosing fenders, contact a marine dealer or supply house. Explain how you moor and use your vessel so they can recommend the best fender type for you. We suggest the type with a fill plug so you can inflate them with a hand pump like the ones used for bicycles.

Outboard Maneuvering

Directing propeller energy (thrust) makes slower speed maneuvering easier. The propeller discharge current is turned from one side to the other which results in turning forces. Rudder boats need water to flow by the rudder to be efficient. Outboard units are designed to have reduced shaft angle, so the propeller does not produce as much unequal blade thrust and resistance. Large horsepower outboard boats do produce more thrust and steering torque but your vessel has the advantage of assisted power steering.

Gathering Headway

When an outboard drive is not moving forward or reverse in the water and the propeller is not turning, (shift in neutral) the boat will not react to the helm steering wheel.

As soon as the vessel is shifted into forward gear propeller action creates a discharge motion and generates energy in the form of thrust. If the outboard drive is centered, the discharge motion is directed straight back causing the vessel to advance forward.

You may notice that if you advance the throttle quickly in initial take-off (make sure you have a firm grip on the wheel), the boat has a tendency to pull the stern of the vessel to starboard. There is a trim tab (also serves as a sacrificial anode) located on the outboard drive housing. This trim tab helps compensate for the low speed steering torque. Once the boat increases headway and the propeller is operating in a faster water flow this torque effect decreases.

Sometimes the trim tab may need adjustment. Contact your Regal dealer for further information or consult your engine manufacturer's manual.

Turning

Once the boat has gathered headway, with the boat planing at the correct bow angle and the outboard drive unit and helm straight the boat tends to stay on a uniform course heading. To assure the boat trim angle is correct use the chart plotter screen trim gauge as a guide while activating the trim button on the remote control panel.

When the helm wheel is turned to the right or starboard, the drive unit is turned in the same direction. The propeller's discharge force is directed to starboard forcing the boat's stern to port. Water flowing past the hull strikes the stern drive gear housing in its starboard side, creating additional turning torque. The stern starts a move to port, forcing the bow to starboard.

If the helm is turned to the left or port the drive turns to port, the stern of the boat goes starboard as the bow turns to port.

As the vessel operator gains experience, he will better gauge each maneuver and speed situation. In this way he will understand the handling characteristics of his boat. He needs to keep the safety of his passengers in the highest priority.

Backing Down

If your boat has the steering wheel and outboard drive straight with the control in reverse, the stern will be pushed a bit to port by the reversing propeller thrust. This tendency to back to port can be eliminated by turning the outboard drive to starboard.

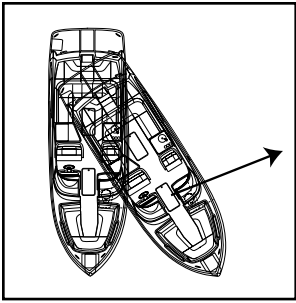

When the vessel begins to gather speed to stern, the water passing by the lower gear case housing will continue to increase steering torque. If the helm wheel is turned to

starboard, and will direct the propeller thrust to port, tracking the stern to starboard.

Wind and current will affect how a vessel backs. Outboard drive boats tend to be light displacements and when backing down in a strong crosswind, the bow will tend to fall toward the windward. This may cause steering problems.

Stopping

Remember that your boat does not have any brakes. It uses reverse thrust from the propellers to stop. If the vessel has headway, with the helm and propeller in reverse the propeller thrust is directed backwards, past the lower gear case. Depending on how far the throttle is advanced, the discharged thrust may not be strong enough to reverse the water flowing by the gear case. As the power is increased, the propeller thrust becomes strong enough to stop the flow of water past the lower unit, and, as the throttle is advanced it reverses its flow more completely.

When water is flowing past the gear case, steering torque is increased, but when the thrust stops the water flow, the boat will not respond to the helm. This is a short lived event and is overcome quickly when the water again flows past the gear case. Furthermore, added to the energy of the water hitting the lower gear case, the propeller thrust is directed by turning the outboard drive unit which can add to the steering torque.

The prop tends to throw the stern to port. This is why experienced skippers undertake a port side landing when wind and current conditions permit. They allow the prop to move the stern to port toward the dock. With a forward motion when the helm wheel is turned hard to one side, the vessel pivots around a point about 1/3 its length abaft to stern.

Docking

When docking it is recommended to use both outside outboards (port and starboard engines). Most docking situations can be accomplished by working the control levers back and forth in gear without the use of additional throttle positions. There are times when wind and/or current may demand the use of port or starboard control handles to increase idle throttle a bit to maneuver in tight situations.

Power Trim/Trim Tabs

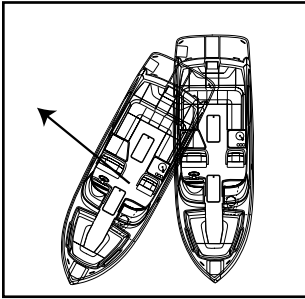

Outboard boats have the ability to angle in or out their drive unit in relationship to the transom. This is accomplished by hydraulic shocks located

along with an electrical sender unit that reads the drive angle and sends information to the chart plotter showing a reading.

Purpose of Power Trim

The purpose of the power trim/tilt is to enable the operator to change the angle of the outboard drive while at the helm. Changing the angle of the drive or “trimming” provides the following benefits:

1. Improves acceleration onto a plane.
2. Maintains boat on plane at reduced throttle settings.
3. Increases fuel economy.
4. Provides smoother ride in choppy water.
5. Increases top speed.

In short, it is a way of fine-tuning the performance of your boat and will enable you to get the most efficient and comfortable ride possible, whatever the conditions.

Using Power Trim

The power trim is normally used prior to accelerating onto a plane, after reaching the desired RPM or boat speed and when there is a change in water or boating conditions.

Position passengers and equipment in the boat so that the weight is balanced correctly fore and aft as well as side to side. Trimming will not compensate for an unbalanced load.

To operate the trim, push the switch until the desired bow position is reached. The trim may be operated at any boat speed or at rest. Avoid operating the trim system when running in reverse. Observe the trim/tilt gauge which indicates the boat's bow position achieved by the trim angle of the vertical drive unit. “Bow-Up” corresponds to the upper portion of the trim range on the gauge while “Bow Down” corresponds to the lower portion of the trim range on the gauge.

To determine the proper trim angle, experiment a little until you are familiar with the changes in your boat. The vessel will be properly trimmed when the trim angle provides the best boat performance for the particular operating conditions. A trim position that provides a balanced steering load is desirable. To familiarize yourself with the power trim, make test runs at slower speeds and at various trim positions to see the effect of trimming. Note the time it takes for the boat to plane. View the chart plotter screen, tachometer and speedometer readings as well as the ride action of the boat.

Operation In “Bow Up”

The “Bow Up” or out position is normally used for cruising, running with a choppy wave condition, or running at full speed. Excessive “bow up” trim will cause propeller ventilation resulting in propeller slippage. Use caution when operating in rough water or crossing another boat's wake.

Excessive “bow up” trim may result in the boat’s bow rising rapidly, creating a hazardous condition.

Operation In “Bow Down” Position

The “Bow Down” or in position is normally used for acceleration onto a plane, operating at slow planning speeds, and running against a choppy wave condition. It is also used when pulling water skiers, tubers, knee boarders, etc. In this position the boats’ bow will want to go deeper into the water. If the boat is operated at high speed and/or against high waves, the bow of the boat will plow into the water.

Operation In ‘Level” Position”

In normal running conditions, distribute passengers and gear so boat is level. At or below cruising speeds, trim the vessel for optimum performance. The trim gauge will show somewhere in the center of the gauge. This position will also enhance running visibility and overall stability. Again, each outing provides different wave, load and running conditions. Be prepared to make trim changes as needed.



CAUTION

THE BOAT TRIM SHOULD BE ADJUSTED TO PROVIDE BALANCED STEERING AS SOON AS POSSIBLE EACH TIME YOU GET UNDERWAY. SOME BOAT/ENGINE/ PROPELLER COMBINATIONS MAY CREATE BOAT INSTABILITY AND/OR HIGH STEERING TORQUE WHEN OPERATED AT OR NEAR THE LIMITS OF THE “BOW UP”OR “BOW DOWN” POSITIONS. BOAT STABILITY AND STEERING TORQUE CAN ALSO VARY DUE TO CHANGING WATER CONDITIONS. IF YOU EXPERIENCE BOAT INSTABILITY OR HIGH STEERING TORQUE SEE YOUR AUTHORIZED REGAL DEALER.

TRIMMED "TO FAR IN" POSITION



TRIMMED "TOO FAR OUT" POSITION

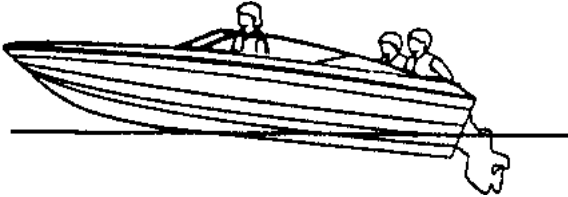

WELL TRIMMED "LEVEL" POSITION

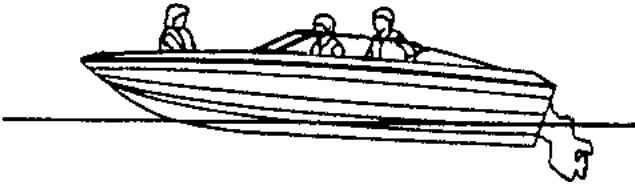

Typical Examples (Stern drive shown)

Shallow Water Operation

Operating your vessel in shallow water presents various hazards. You are more apt to hit a submerged object such as a rock, sand bar, stump coral, or other unmarked objects.

Pay close attention to your charts for descriptions of any shallow areas along with marked submerged objects. Always post a lookout when operating in shallow water. Trim your outboard drive up as needed to provide adequate draft. Set the alarm on your depth sounder and travel at a speed that will keep the boat level in these shallow areas.

If your boat strikes a submerged object stop immediately and check for hull, outboard drive and propeller damage.

Anchoring

Selecting the correct anchor is an important decision. The anchor style in part depends on the usage and boat type. Regal boats designate an anchor type and or model. Some models incorporate chain, line with an optional windlass. Contact an authorized Regal dealer for more information.

Anchoring is easier with another person on board. First be certain that the line for the anchor is properly attached, to avoid losing the anchor and anchor line overboard.

For most anchors to perform more efficiently, you should attach 3 to 6 feet of chain. The chain will stand up to the abrasion of sand, rock, or mud on the bottom much better than a nylon line. It should be galvanized to reduce corrosion. Next, attach a length of nylon line to the other end of the chain. The nylon will stretch under a heavy strain cushioning the impact of waves or wind on both the boat and the anchor.

To anchor, select a well protected area, preferably with a flat bottom. Contrary to modern belief, you do not throw the anchor over while the boat is making headway, or moving forward. In fact, the bow of the boat should be brought slowly backward, while easing the anchor slowly over the side of the boat until it hits the bottom. To “snub the line” means to stop its outward “pay” or movement. Usually the length of anchor line used should be 5 to 10 times the depth of the water.

After you have anchored, check your position with landmarks if possible. You need to continue to monitor landmarks to make sure you are not drifting.

Since anchoring can also be an emergency procedure, the anchor and line should be readily accessible.

For increased holding power in windy conditions, two anchors are sometimes set. If your primary anchor drags, you can run out your secondary anchor without picking up the primary one. The important thing is to lay them out at an angle. When setting two anchors, make sure they are fastened to separate rodes or cleats. This is done in case you need to adjust one later so the line is accessible. If two anchors are used ahead of a boat, make sure to set the rodes at an angle than in a straight line to reduce the chances of tangling as the boat moves in wind and current. See the illustration.

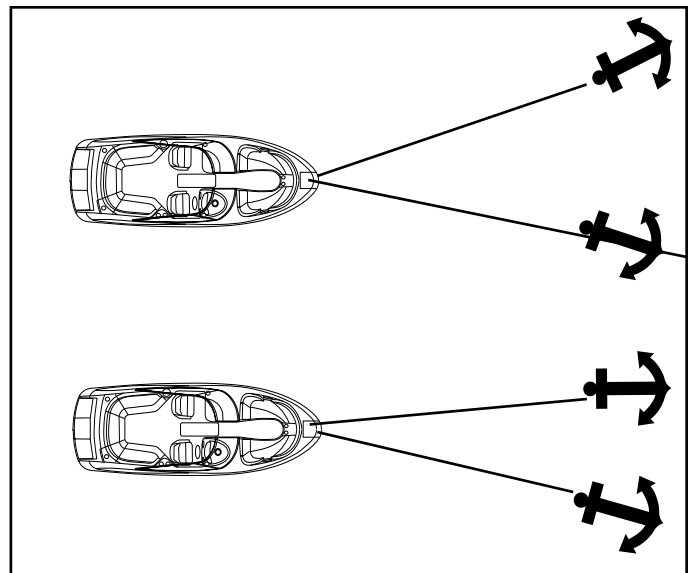

The Law Of Salvage

The Admiralty law sometimes referred to as the salvage law was founded primarily on English law fundamentals and basically says that a vessel distressed, in danger of flounder, if rendered assistance from a towing company or private agency, can be forced to relinquish a portion of the vessels' worth for the assistance received.

NOTICE

IN THE EVENT
YOUR VESSEL IS IN DISTRESS,
PRIOR TO ALLOWING ANY TOWING
COMPANY OR PRIVATE AGENCY THE
RIGHT TO PASS A LINE TO YOUR VESSEL,
BE SURE TO ESTABLISH THAT YOU
DO NOT AGREE TO SALVAGE RIGHTS.
ESTABLISH WITH THE CAPTAIN
OR OPERATOR THAT YOU WISH TO BE
ASSISTED IN A CONTRACT BASIS AND
ESTABLISH A PRICE.
OF COURSE IN CERTAIN SITUATIONS, YOU
MAY NOT HAVE THIS OPTION.

USE YOUR BEST JUDGEMENT!

Towing

In case you find yourself aground or in need of a tow, or should you want to tow another vessel, keep in mind that you never use deck hardware or cleats to secure lines for towing!

Deck hardware is intended for mooring and anchoring, and is not designed to withstand the strain and pull of towing. Rather than tie the line to your cleats on deck, it is suggested that you tie a bridle by passing a line completely around the hull of your boat to avoid damage.

When towing, always stand clear of a taut line, as any type of line breaking under stress can be extremely dangerous. The preferred line for towing is double-braided nylon, as it has sufficient elasticity to cushion shock loads. Move slowly and cautiously.



WARNING

AVOID INJURY OR DEATH!
DO NOT USE DECK HARDWARE
INCLUDING CLEATS
FOR TOWING.

Knots

Knots are useful in docking, towing and other emergency situations. Learning to tie knots requires practice. As they say “Practice makes perfect”. Some of the knots used in boating are the square, bowline, anchor bend, clove hitch, figure eight and half hitch. There are several periodicals available that explain various knots and how to tie them effectively. An experienced skipper will know the basic nautical knots and will use them when on the water. Take the time to know the basic knots.

**Figure 8 Knot
Tied To Cleat**



A useful knot to learn for general docking is the figure eight with one end reversed. By turning the free end of the line back under, the knot can be released without disturbing the boat. After some practice one person can secure a vessel easily to a dock or pier in a variety of weather conditions. This knot normally is used to tie the bow and stern. Then the vessel can further be fastened by tying the spring line in the figure eight knot. Wrap it around the cleat 2 or 3 times.

Emergencies

Always be ready to help others on the water if possible, but do not take any unnecessary risks. Use equipment to save a life, but do not risk a life to save equipment. Consult earlier information in this manual concerning accidents, etc. Also, read other literature concerning on the water emergencies. Be alert and prepared!

Fires

Fire aboard a vessel can spread quickly and can cause tremendous alarm among everyone. Most fires can be prevented by keeping the bilge free from oil and debris. Keep all equipment stowed and maintained in working order. Carry a backup fire extinguisher on board. If something becomes a possible fire hazard, remove that possibility at once. Never use water on gasoline, oil or electrical fires. When you dump water on an electrical fire you can be shocked since water conducts electricity.

Follow these instructions if a fire breaks out:

- A. Fit everyone aboard with a life jacket. Turn off the ignition.
- B. Try to keep the fire downwind. If the fire is to the stern, head the bow toward the wind. If forward, put the stern to the wind.
- C. If the engine should catch fire, shut off the fuel supply. Usually there is a fuel tank access that you can crimp the fuel feed line.

D. Use a hand fire extinguisher. Make sure to point it at the base of the flames. Use short bursts and sweep the extinguisher side to side.

Note that a 4 lb. extinguisher discharges in approximately 20 seconds.

These actions help prevent the fire from spreading to other parts of the boat. You can extinguish fires quickly if you act swiftly. Have a plan of action in motion in case a fire breaks out.

First Aid

Knowing first aid can save lives. A first aid kit and the ability to use it are important ingredients for the safety of a skippers' passengers, crew and vessel. Having confidence and competence in handling medical emergencies on board is a must for the skipper. Invest your time in a first aid course available at the American Red Cross.

CPR (Basic Life Support)

If someone is seriously injured have someone call for help while the injured person is being attended.

Check for possible danger signs; loss of breathing, unconsciousness, severe bleeding and heartbeat. If you determine the individual is not breathing or unconscious place the victim on their back on a hard surface and do the following:

1. If unconscious, open the airway. Neck lift, head lift or chin head lift.

2. If not breathing, begin artificial breathing. Pinch the nose. Give 4 quick breaths. If airway is blocked, try back blows, abdominal or chest thrusts and finger probe until airway is open.

3. Check for pulse. Begin artificial circulation. Depress sternum 2".

15 compressions rate 80 per minute. 2 quick breaths. Continue uninterrupted until advanced medical support is available.

Follow up immediately with medical authorities!

Hypothermia

Hypothermia is a condition where the body temperature decreases because the body can't generate enough heat to maintain its normal temperature. It can be serious and usually occurs where victims have been immersed in water (under 68 degrees) for extended periods of time. If you encounter a possible hypothermia victim call for help on the radio and get the person out of the water.

Symptoms are:

1. Shivering that if condition is advanced may stop.
2. Confusion, clumsiness or slurred speech.
3. Rigid muscles.
4. Semiconscious to unconscious.

Treat hypothermia by the following:

- Remove wet clothing.

- Monitor the victim's pulse and breathing.
- Rapidly apply heat to the body core by using blankets, naked bodies or warm water.
- Do not give the person any food or drink.
- Do not warm the arms and legs. Warming of these extremities can be fatal.

Follow up immediately with medical authorities!

Environmental Awareness

There are numerous vessels operating on our waterways on a daily basis. Each boat has an impact on our environment. Boat operation habits, marine sanitation, and maintenance all play a role in a delicate battle to keep the ecosystem clean. Each of us has a role in doing our part as an environmentally conscious skipper to conserve our waterways.

The National Marine Manufacturer's Association lists their top ten of Eco-Boating Practices as follows:

1. Observe all regulatory agency policies regarding marine toilets.
2. If equipped with a holding tank, use marina pump-out facilities.
3. If used, make sure bottom paints are legal and ecosystem friendly.
4. Use only biodegradable cleaning agents.
5. Dispose of all garbage and litter on shore properly, not on the water.
6. Don't top off fuel tanks. Leave expansion room. Clean up spills.

7. Watch your wake and propeller wash.

8. Make sure your engines are well tuned and maintained.

9. Control your bilge water.

10. When fishing, practice the "catch and release" principle.

Follow these basic practices when on the waterways. Treat the environment in a way that you would like to be treated.

Chapter 7

Auxiliary Equipment Operation

Overview

This chapter will assist the boat operator in understanding selected standard and optional equipment components on the vessel. *Select equipment described may not be installed on your boat or the pictorials may not exactly resemble equipment on your craft.* Remember, Regal is constantly improving its product line and therefore may make changes in vendor parts and specifications without notice. For detailed information on equipment, please refer to the owner's information packet.

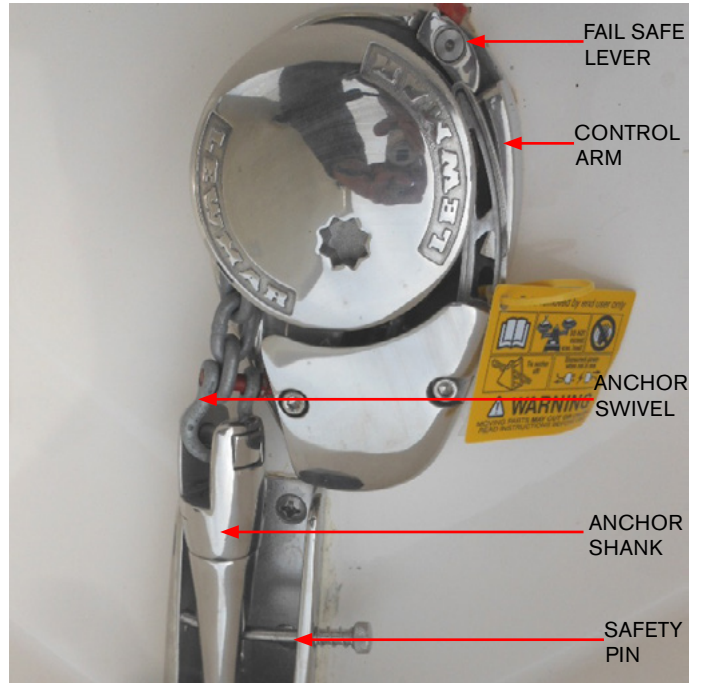

Anchor Windlass (Typical)

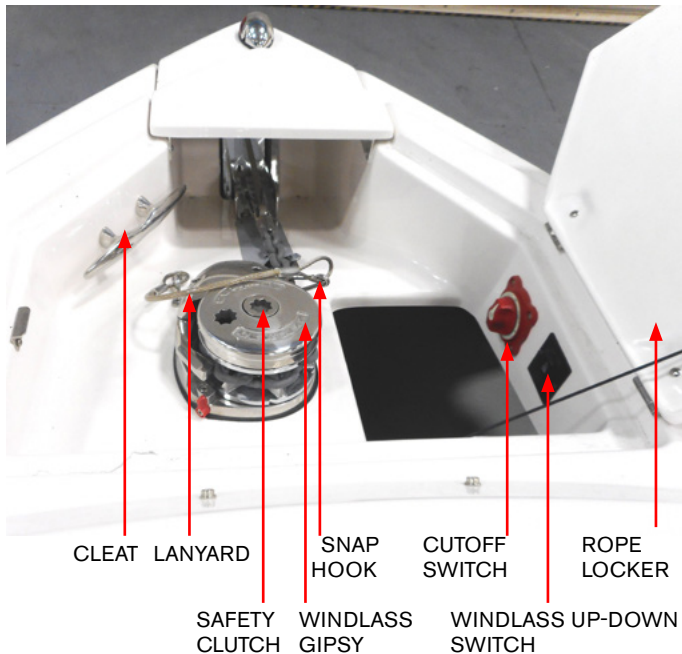

Anchor Windlass Introduction



If installed the windlass features a stainless steel polished "claw" style anchor complete with swivel. Claw's include high holding power in most seabeds.

A momentary windlass rocker switch located at the anchor locker controls the lowering and retrieving of the anchor through the windlass. A 50 amp breaker for windlass over current protection is located at the battery management panel. There is a lanyard with a snap hook to add holding power when the anchor is in the stored position. The cleat is for tying off the anchor rode rather than maintaining constant pressure on the windlass itself.

Note: Never use the windlass to break the anchor free from the bottom. This may cause excessive strain on the windlass motor and or hardware.

Using Anchor Windlass

The windlass may be outfitted with a rode using 100' of 1/2" nylon rope along with 10' of galvanized chain. The chain is connected to the anchor shank which is next to the anchor. The chain acts as a safety margin to protect the rope rode from being damaged by sharp seabed objects such as coral that might sever the rope if it was next to the anchor. If needed for harsh sea bottoms the rode can be converted over to 100' of 6 mm galvanized chain with a small length of rope at the top for tying off the rode to a cleat.

The safety clutch is used to "pay out the windlass chain or to retrieve the anchor "rode". There is a handle in the anchor locker that inserts into the gypsy drive cap located on top of the windlass framework.

With the handle inserted in the cap, turn the handle *clockwise* which grips the "gypsy", locks it and **tightens the clutch**. Remove the handle and store it after usage.

To **loosen the clutch** with the handle inserted in the cap, turn the handle *counterclockwise* which will free up the "gypsy" from the drive train. Remove the handle and store it.

Before attempting to "pay out" the anchor **ensure that the fail safe pawl is disengaged from the gypsy and held clear of it by the fail safe lever**. See windlass owner's manual for further information.

Be sure to pull the safety pin from the anchor shank before using the system. *The anchor will not pay out with this pin inserted.* This pin should be reinstalled after each anchor retrieval.



WARNING

AVOID SERIOUS INJURY!
ENSURE THAT ALL BODY PARTS & CLOTHING
ARE KEPT CLEAR OF THE ANCHOR RODE
AND WINDLASS DURING OPERATION.



WARNING

AVOID SERIOUS INJURY!
DO NOT "PAY OUT" ANCHOR UNTIL IT IS
DETERMINED THAT THERE ARE NO
SWIMMERS OR DIVERS NEAR THE AREA.

Paying Out Anchor Using Gravity

To let out the anchor release any anchor locks, insert the clutch handle into the gypsy drive cap and turn it in a clockwise direction to tighten the clutch. When in a safe mode, pull back on the clutch until the anchor and rode begin to pay out. Control the rate of anchor descent by pushing the clutch lever forward. When the desired rode is paid out, tighten the gypsy drive cap.

Paying Out Anchor Using Power

Make sure any anchor locks are disengaged and the pin through the anchor shank is pulled along with the lanyard hook. Stand clear of all windlass components when paying out. Using the windlass momentary switch, press and hold the lower portion of the switch.

When the proper ratio of anchor rode is paid out disengage the switch and tie off the rode to a cleat since it is not recommended to let the windlass mechanism be the only source holding the rode to the anchor on the sea bottom. Also, do not use the fail safe pawl to hold the anchor load as windlass damage could occur.

Hauling In Anchor-Manual Recovery

Insert clutch handle into the gipsy drive cap and turn clockwise until anchor is fully returned to the bow roller.

Hauling In Anchor-Using Power

When anchor rode is safe to haul in use the windlass momentary switch to haul in the anchor rode. Press and hold the upper portion of the switch until the anchor is returned to the bow roller position.

The fail safe pawl does not need to be disengaged during retrieval as it will act as a ratchet. When the anchor has been retrieved in the bow roller position the fail safe pawl should be left engaged in the gipsy to prevent accidental activation of the windlass while underway. Also, reinstall the pin through the anchor shank and the lanyard hook. Note that the fail safe pawl does not need to be disengaged from the gipsy before the anchor can be paid out again.

It is recommended that during the paying out process the engines be run to stern before full scope is reached. This will help prevent the rode from being tangled in the anchor on the sea bottom. It is recommended that during the retrieval process use the engine to gather headway.

Do not let the vessel sit directly on top or over the area where the anchor lies because the chain rode could damage the hull topside.

As the anchor raises toward the scuff plate area, retrieve the last few feet very carefully to eliminate any hull damage.

Once the anchor is retrieved, check to ensure the fail safe pawl is engaged in the gipsy which will help prevent accidental activation.

Windlass Safety Tips

1. Read the windlass owner's manual.
2. Keep all body parts and clothing away from an activated windlass.
3. Do not exceed the maximum load designated by specifications.
4. Always tie off the anchor rode to the designated cleat.
5. Do not use the windlass to pull or tow another vessel.
6. Always shut off windlass breaker or main battery switch before servicing the component.
7. Always use engine power to gain headway before retrieving anchor.
8. Always look for swimmers or divers before deploying anchor.
9. Always secure rode/anchor while cruising or pulling vessel on highway.

Autopilot

If installed, the autopilot is part of the onboard marine network and therefore can be programmed to maintain a course through the chartplotter route. Easy-to-use setup provides carefree auto-guided navigation in open waters.

Autopilot Operation

The autopilot continuously adjusts the steering on your yacht to maintain a constant heading. The unit can be programmed for both automatic and manual steering functions and patterns.

Before using the auto pilot, be sure to read and understand the autopilot operation manual located in the owner's information packet.

 **WARNING**

TO PREVENT POSSIBLE BODILY INJURY, DEATH OR PROPERTY DAMAGE, NEVER LEAVE THE HELM UNATTENDED. BE PREPARED AT ANY TIME TO PROMPTLY REGAIN MANUAL CONTROL OF YOUR VESSEL.

Follow these steps to start-up the autopilot;

1. Energize the "house" battery switch at the battery activation panel located under the cockpit starboard cushion.
2. Press and hold the power button briefly to turn the autopilot on or off. If the power button is released quickly instead of briefly holding it the unit will seek the display adjustment screen versus the main screen.



General Operation Keys & Descriptions

Power- Turns the autopilot on and off.

Soft Keys- These keys help to navigate the menus, select items, and change the autopilot steering bearing. The center soft key is used to select highlighted items and open a menu. The left soft key is used to engage the unit or to move back one screen. The right soft key is used to navigate through the menu screens. *Note to press a soft key to activate the action indicated directly above it.*

STBY (Standby)- Press this button to start the standby function. Press STBY to stop the autopilot from any menu screen at any time. A time when you use STBY might be when you are beginning your route through a tight turning channel to a marina or to your favorite on the water restaurant.

Note 1: When you place the autopilot in standby mode be ready to regain manual control of the boat steering system.

Note 2- The heading sensor is a device that is integrated in the autopilot system that controls the direction inputs and outputs of the unit.

Status- If you press the STBY button on the heading screen “YOU HAVE THE HELM” appears in yellow cautionary lettering. At this point be prepared to manually take control of the helm steering. Under normal conditions on the heading screen the status reads “AUTOPILOT ENGAGED” in green lettering.

Heading- When you engage the autopilot, it takes over the helm steering control and steers the boat to maintain your heading. This heading can be programmed through the autopilot which uses an on board flux-gate compass for bearings based on a magnetic north verses a true north heading. The autopilot heading can also be programmed through the chartplotter to follow a set of way points.

Actual Heading Marker- A yellow triangle (actual heading marker) is displayed and is normally the bearing you are heading.

Note: If the arrow keys are pressed to manually adjust the heading, the heading dial on the heading screen displays your actual heading while the autopilot steers the yacht to the intended heading.

Pattern- This screen icon shows various steering patterns for fishing and other speciality patterns such as zigzag, circles, U-Turn, and Man Overboard. Read and understand the autopilot owner’s manual description of these patterns and make sure the water is free of obstacles and you have an unlimited area to practice these steering patterns.

Bilge pump

Before each outing, check the operation of the bilge pump, automatic switch, and manual switch. The bilge pump should automatically activate when water reaches a pre-determined height in the engine compartment. Test the bilge pump manually at the dashboard with the switch. Periodically check for bilge debris around the grates of both the bilge pump and automatic switch, and also bilge pump impeller.

The automatic mode for your bilge pump works similarly to the manual method. Both methods control the bilge pump by a switch, but the automatic mode utilizes a float switch. Float switches have a float that sits at water level, and when the float reaches a certain height, it trips the switch and activates the bilge pump.

Periodically you may need to disassemble the bilge pump from the grate in order to clean or access the inner mechanisms. To remove the bilge pump, utilize the quick disconnect tabs on either side of the bilge pump, squeezing them like a backpack clip while pulling up on the pump.

For switch control location, refer to the engine and controls chapter. For bilge and drainage system information and electrical system information, refer to the systems chapter. Refer to the vessel operations chapter for pre-departure use.

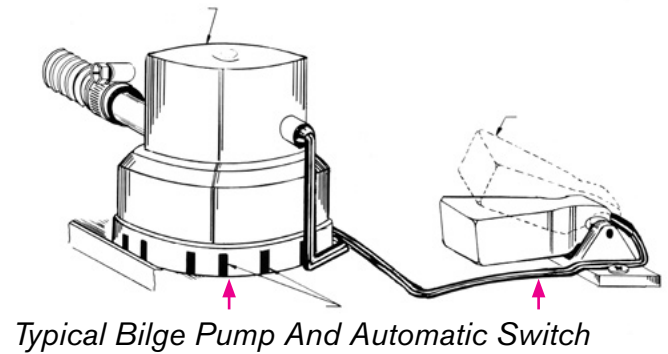

Bow Table (Typical)

If installed the teak bow or cockpit tables are found in the cockpit Lazarette locker. The table may be secured to the underside of the locker in a bulkhead. The high gloss tables feature teak a hardwood known for beauty and durability.

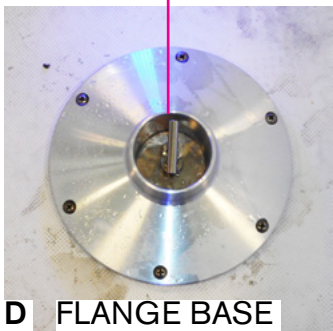

Setting Up Bow Table

1. Remove the table from the locker lid.
2. Find the flange base which is located in a bow locker under the locker lid.
3. Unscrew the flange base center hold down mechanism and the entire unit will free itself.
4. Center the flange base over the floor base and line up the center holes. Screw the hold down mechanism clockwise until tight.
5. With the table turned over loosen the knob on the table support.
6. Insert the leg into the table support. Tighten the knob until secured.
7. Lift the table and leg assembly up and insert into the flange base. Wiggle the sides of the table as needed to until the leg is completely down.
8. To disassemble table reverse the process.

Note that it is recommended that the table assembly be stored before making a major cruise into rougher seas or other adverse weather conditions.



Bow Thruster

General Safety Notices:



1. Be sure to read and understand the safety information and all thruster operation information before attempting to use the thruster system. Refer to the thruster manufacturer's

owner's manual for more detailed information.

2. Do not operate the bow thruster system close to swimmers as a high powered suction is produced at the propellers.

3. Make sure the propeller lock nut is torqued to the required foot pound specification.

Thruster Usage

To use the thruster first make sure the battery switch is activated. If necessary there is a on/off battery switch in the bilge that is in-line with the thruster power cable feed. Make sure the switch is energized.

NOTE that there is a joystick on the helm. The thruster will assist in slow speed maneuvering especially around a dock or close mooring situations. It operates similar to a gaming or marine propulsion type joystick. To activate the joystick, push and hold the black button. The red icon will illuminate.

Never run the thruster dry; it will weld the relay contacts as it becomes a generator in spool down.

Do not make quick changes from one direction to the other direction, or it will damage the unit. The minimum running voltage for the thruster is 10.5 volts; therefore the outboard engine(s) should be running to maintain this voltage requirement.

There is an in-line ANL type fast activation fuse for over current protection behind the thruster switch panel.

Bunk Conversion From Seat

The cabin seat converts to an extended berth. There is an up and down switch on the head wall to activate the actuator. Note the up and down switch arrows.

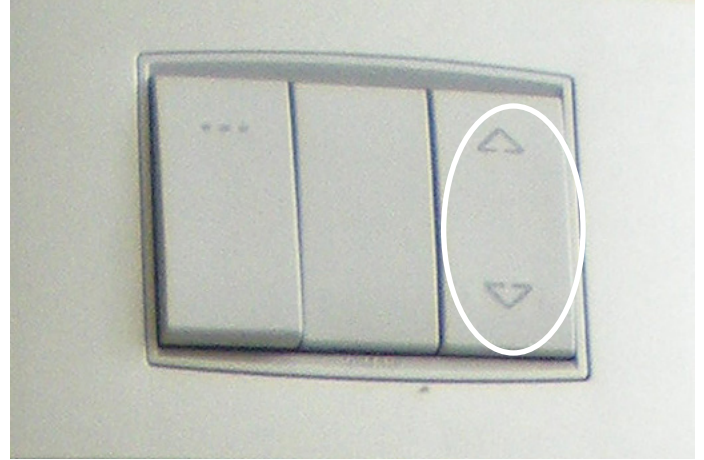

Note that the bunk actuator draws a low amperage and does not require a relay module. The switch itself performs the up and down function.

Photo below displays bunk actuator switch panel.



Cabin Entrance Door (Typical)



The companionway door is a lockable slider type engineered with heavy mechanical joints for added strength. The aluminum frame is typically finished in a weather resistant polyester powder coating. The tinted door surface is a high impact acrylic.

Note that when underway always ensure the companionway door is closed and locked. When moored ensure that if the door is left open and the latch at the bottom track is flipped across the track to prevent the door from closing (See photo).

Read and understand the care instructions in the care and maintenance chapter since the door track and rollers may require periodic lubrication.

Note to safely secure an extra door key somewhere for emergency use.

Cabin Entrance Door Drainage Cover

Located just aft of the door sill is a stainless steel grate cover and a drainage locker. It is a segment of the cockpit drainage system. Water enters through the grate slots and travels through scupper drains and hoses and is exited hull side.

Periodically remove the grate and clean any debris from the scupper screens located in the bottom of the drainage locker.

In addition, it is recommended that you ensure all other cockpit drain scuppers are free of debris.



Note that the cockpit drainage system is an important ingredient when operator finds himself in high wind and rain environments. Make sure to keep equipment away from the transom doors as the majority of all water will flow under those doors overboard while making headway besides the cockpit scupper drains.

Canvas (Typical)

Typically, there is a variety of canvas available for your vessel including bow cover with cockpit seat cover, manual bow and sunshade covers and helm enclosure.

Of course any of the above selections will improve the overall comfort and longevity of the parts that they cover. See the care chapter for cleaning information on vinyl canvas types.



Cockpit Grill (Typical)



Be sure to read the grill manual to become acquainted with all the safety features and proper modes of operation before attempting to use the grill. To use the cockpit electric grill you must activate the dedicated breaker on the ship's main panel.



Of course you must either be on dock side power or have the generator running as the grill operates at 120 volts.

Next, locate the grill controller on the face of the cabinet. Push the center button to activate the grill.

Change the grilling temperature by using the plus or the minus buttons on the grill control. There is a safety shutdown switch located at the aft grill corner. Read the grill owner's manual for further information.

Always have a fire extinguisher handy. Should there be an emergency situation close the cover. Power to the grill will be shut down at this point. After grilling be sure to let the element cool before closing the cover.

There is a GFCI in-line located on the grill power cord. There is a reset button on the cord should the device trip. An access is provided for the GFCI. Always find the reason for a tripping occurrence before resetting the device.

Cockpit Grill- Safety Instructions

1. The unit is designed to cook food like meat, fish or vegetables. Do not use it for any other purpose since it could be dangerous.
2. Do not operate the grill in rough seas or high winds.
3. Do not add burning type charcoal briquettes or volcanic stones to the unit.
4. Never operate the grill while making headway (under engine power).
5. Never grill with the canvas in the up position since smoke and odors from cooking could infiltrate the canvas fabric over time.
6. Keep combustible material away from the grill.
7. Keep children away from a hot grill surface.
8. Keep the grill covered when not being used.
9. Let the unit cool down before attempting to cover it.
10. Clean grill tray after each use to prevent fires.

NOTICE

THE GRILL RESET BREAKER IS ACCESSIBLE BY PULLING THE TRASH CONTAINER OUT. THERE IS A BLACK BOX W/ A CUT-OUT AREA. RESET BUTTON INSIDE RECESS.

Cockpit Refrigerator (Typical)

If installed, the cockpit refrigerator provides chilled and frozen storage areas for food and beverage with a volume of 49 liters or close to 1.75 cubic feet capacity. It features a brushed 316 grade stainless steel door and LED lighting along with an easy reach digital thermostat bank. The bin and bottle racks keep supplies secure in rough weather. Includes a freezer drawer. The unit operates at 12 volts DC voltage and draws approximately 6 amps along with requiring a minimum of 10.9 volts.

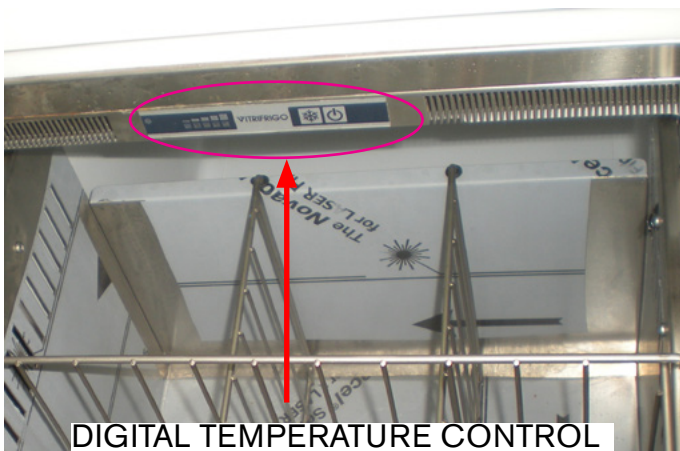

Using Thermostat Control

Note the thermostat (temperature control) in the above illustration. This device digitally sets the refrigerator temperature and features 5 individual temperature levels.

Note the power “on” touch control on the right. The snow flake to the left is the power button on the refrigerator.

Note that an optional ice maker may be installed with the same type of digital bank control feature.

Usage Recommendations

- If possible, the refrigerator should be turned on for about 6 hours prior to filling food items.
- Frequent opening of the refrigerator door will result in greater consumption.
- Ensure that nothing blocks the refrigerator vent.
- Keep the inside of the refrigerator clean and dry.
- Keep the surface of the door clean and dry.
- The unit has been designed with a product lock protection in the event of low battery voltage. In the event of a compressor block, follow the instruction in the manufacturer’s owner’s manual or contact a marine technician.
- Note that the compressor can operate up to angles of 30 degrees; greater angles can cause damage to the compressor.
- Note that the unit contains refrigerant type 134 A. In the event of a loss of refrigerant contact a qualified certified technician.
- Periodically clean the condenser unit behind the refrigerator. Dust or vacuum the fan from any dust or lint debris.
- See the manufacturer’s owner’s manual for defrosting instructions.
- Consult the manufacturer’s owner’s manual for any troubleshooting information or contact your closest Regal dealer.

Cockpit Sea-grass Mating



If installed, cockpit sea grass mats feature urethane backing for marine environments. The mats provide style, comfort and durability as well as additional

protection in environments where microbes are a concern.

Chilewich® products contain Microban®. This antimicrobial protection inhibits the growth of stain and odor-causing bacteria, mold and mildew for the product's life.

When storing your sea grass mats, always roll with the face of product out with the backing facing in. Do not fold or crease as the backing may split. Vacuum or hose off for regular cleaning. Dry face up or hang. Do not machine wash.

Matting may be cleaned with a mild detergent and a sponge. Rinse with fresh water.

Note not to pull on material when removing from cockpit, but rather lift the snap instead to disengage.



Cockpit Seat (Aft)

The aft cockpit seat features an actuator system to fold the seat up to provide additional cockpit space.

There is a switch located on the side of the seat. Press the upper side of the switch to store the cushion. Press the lower side of the switch for sitting position.



Electronics

Various electronics components are available on the vessel including a cockpit hard top installed television, satellite KVH system, VHF radio, HD closed radar system, FLIR camera system and autopilot.

Each component utilizes individual operator's manuals. Refer to the appropriate electronic component operator's manual for detailed product information since the vast amount of information can not be covered here.

These manuals will cover features, operation, alarm and safety systems along with maintenance schedules. Limited component information and notes are found in this chapter.



Fender Clips

The fender clip option features receivers integrated into the vessel hull side and quick release pins. The quick release pins attach to fenders with lines so they are ready to deploy as needed. When the vessel approaches a mooring the quick release pin with fender is attached to the receiver and pushed into place. This will help protect the boat from dock "rash" which could damage the rub rail or gel coat. When leaving the dock the pins feature a quick release mechanism which detach easily.



FENDER CLIP RECEIVER



FENDER CLIP RELEASE PIN

Helm Seat Operation (Typical)



The vessel features quad cockpit helm seats. They all move back and forth to provide comfortable seating positions. The outside helm seats swivel to face the vessel aft. All provide twin flip up arm rests.

Space age vinyl with special UV inhibitors help provide protection against the rays of the sun and the harsh marine environment. The marine grade vinyl thickness improves seat durability, longevity, and comfort.

All seats fold and provide a teak surface for additional food and beverage use while at mooring.

Helm seat technology integrates seat risers for increased visibility and/or additional space at the helm.

Read the vinyl care information in the care and maintenance chapter.

Helm Seat Operation (Con't)



All helm seats provide movement forward and aft through a switch located at the side of the seat. Press the forward or back end of the switch to navigate the seat fore and aft.



Helm seat technology includes the ability of the outer helm seats to rotate fore or aft. To activate the swivel there is a bar. Lift the bar with one hand and rotate the seat with the other until the desired position is obtained. Release the bar to lock the swivel.

Note to read and understand the swivel warning label on the side of the swivel shown in orange above.

Joystick

As part of the Yamaha Optimus steering system you may have a joystick installed on your vessel. The joystick permits the vessel to maneuver in tight mooring situations even made more opportunistic with wind and water conditions such as current. The joystick permits the boat to move 360 degrees and features a boost feature.



The joystick controls the port and starboard engines only.

For further information regarding the engine joystick refer to the engine operator's manual located in the owner's information packet.

Mid-Berth Setup

The mid cabin settee can be converted to a large sleeping berth. The fill cushions are located under the port side berth cushion. Under the port settee cushion are molded cut-outs.



Remove the settee cushion to allow space to fill in each cushion with the support rail. As each filler cushion is added to form a berth the support rail fits between the cut-out spacer and the cut-out inside radius for support.

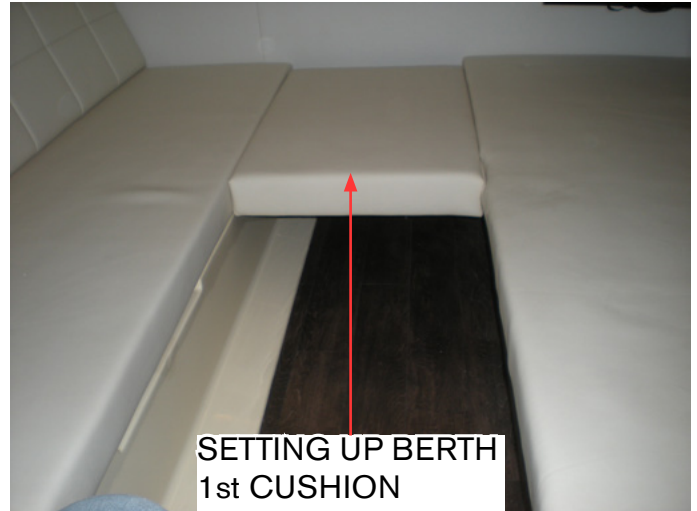
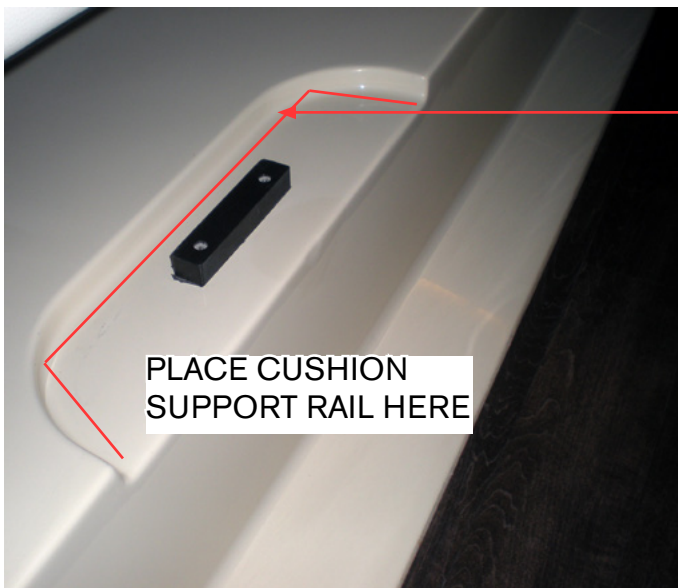

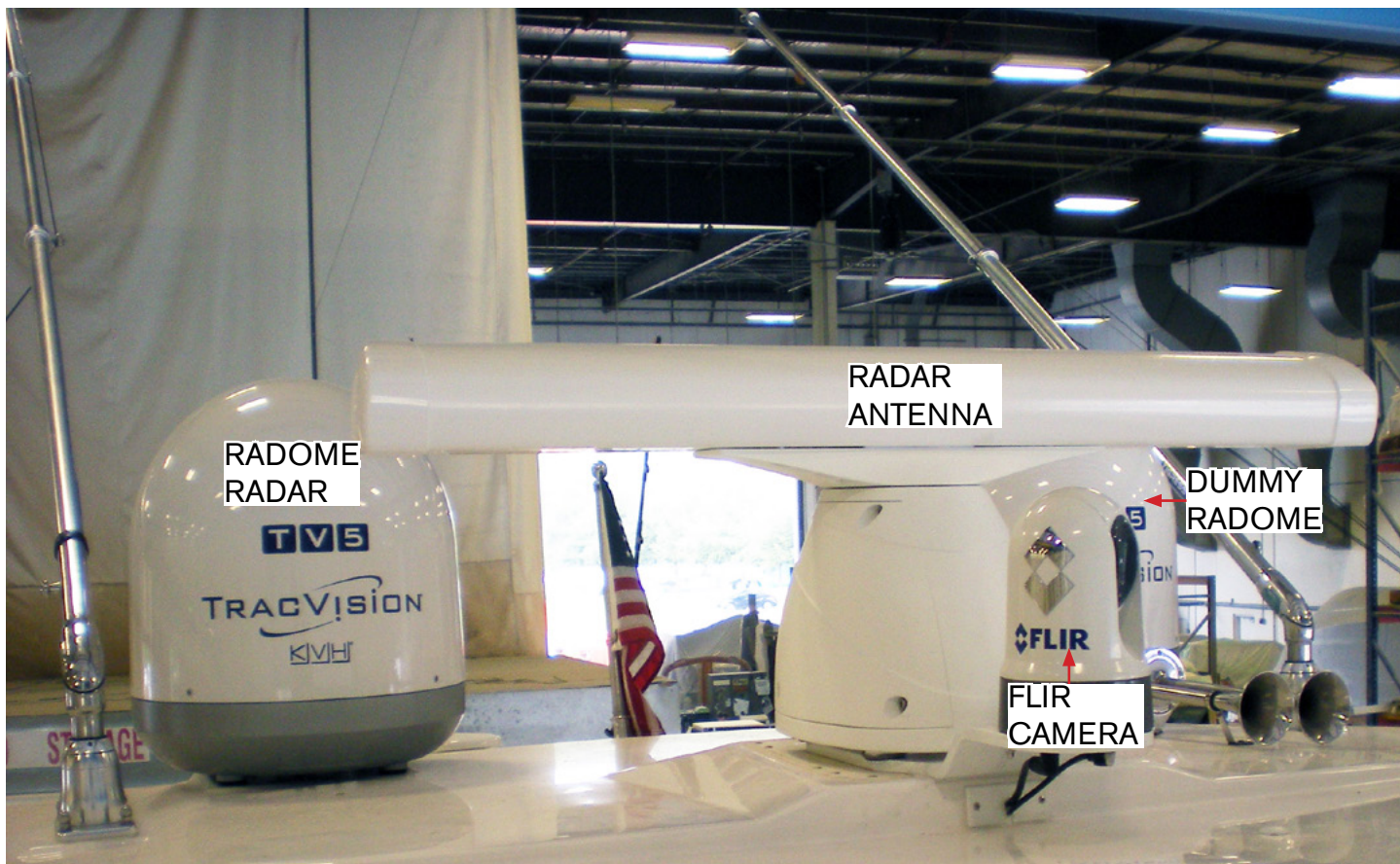

Radar-Garmin Radome HD Open-Array

If installed, the radar features an 18" Radome with 4 KW of output power. Dual range operation permits fully independent split screen display of close and far radar views. Uses 24 or 48 revolutions per minute rotation speeds with a 48 mile maximum range setting along with a 20 meter minimum range. There is a

Read and understand the radar operator's manual before attempting to use the component. Pay close attention to all safety labels.

Note that the standard "dummy" radome depending on boat options may house other electronic equipment such as KVH satellite TV.

FLIR Camera System

If installed, the FLIR infrared camera system features the ability to pan objects ahead, to the side and tilt 90 through 110 degrees. The camera uses an automatic window along with 320 x 240 resolution thermal sensor and H264 encoded IP digital video stream.

Basic operation uses thermal imaging (infrared) cameras to see clearly in low-light and no-light conditions. The camera is a network device that communicates over an Ethernet network (network extender/router located in the cabin under the headliner.

The camera is controlled with the video menu on either chartplotter. Read and understand the FLIR operator's manual before using the camera system.

SeaDek



As an option SeaDek® is featured on select vessel cockpit sole areas. The non-skid, closed cell material is derived from UV protected non-absorbent foam. You will find the product easy to clean with a high stain resistance.

Other features include noise reduction, great traction even when wet, body comfort when standing, walking or leaning on the swim platform. To clean small dirt particles first try soap, hot water and a stiff brush. For surface dirt and footprints use glass cleaner and a clean rag.

If a more thorough cleaning is needed you may use bleach, 409, Simple Green or Soft Scrub. Be sure to rinse thoroughly. Stay away from using any acid base cleaners.

Seakeeper

If installed, the Seakeeper uses gyroscopic principles to reduce boat motions in waves and wakes independent of boat speeds. A typical unit consists of a Gyro assembly, a CAN communications cable, and a helm display.

If installed, the Seakeeper is located under the aft cockpit of your vessel. The unit's cycling is controlled by an electronic controller and a hydraulic brake throughout each roll cycle as to supply maximum anti-roll torque and limits mechanical contact with the hard stops that limit the gimbal angle travel.

The Seakeeper operates from DC (direct current) and the unit is part of the 2 house battery circuitry. There is a dedicated 100 amp breaker on the fire wall.

Seakeeper Display

The helm display is used to start, operate, monitor and shutdown the Seakeeper. Sensors, alarms, and shutdowns are provided to allow unattended operation. The display provides information in the event of an alarm. Select alarms can cause precession to stop and start the unit to coast down.



TYPICAL SEAKEEPER 3



WARNING

AVOID SERIOUS INJURY!
DO NOT REMOVE THE COVERS FROM THE UNIT OR CONTACT ANY PARTS WHILE THE UNIT IS PRECESSING. MAINTENANCE SHOULD NOT BE DONE UNLESS THE SEAKEEPER IS LOCKED AND FLYWHEEL HAS STOPPED SPINNING.



WARNING

AVOID SERIOUS INJURY!
ENSURE ALL BODY PARTS & CLOTHING ARE KEPT CLEAR OF THE SEAKEEPER WHILE IT IS CYCLING.

After 12 volt power is present. the Seakeeper screen will energize and a home screen will appear. Here the ON/OFF touch screen button will appear grey (OFF). Once the button is pressed it will change to blue (ON) and menu button is used.

When the menu button is pressed, a menu bar will appear or disappear at the screen bottom. The menu bar is used to navigate between pages. Refer to the Seakeeper operation manual for further information regarding the display, operation and understanding the alarm screens.

Also, specifications, troubleshooting, winterization, warranty, and periodic maintenance requirements are found in the operation manual.

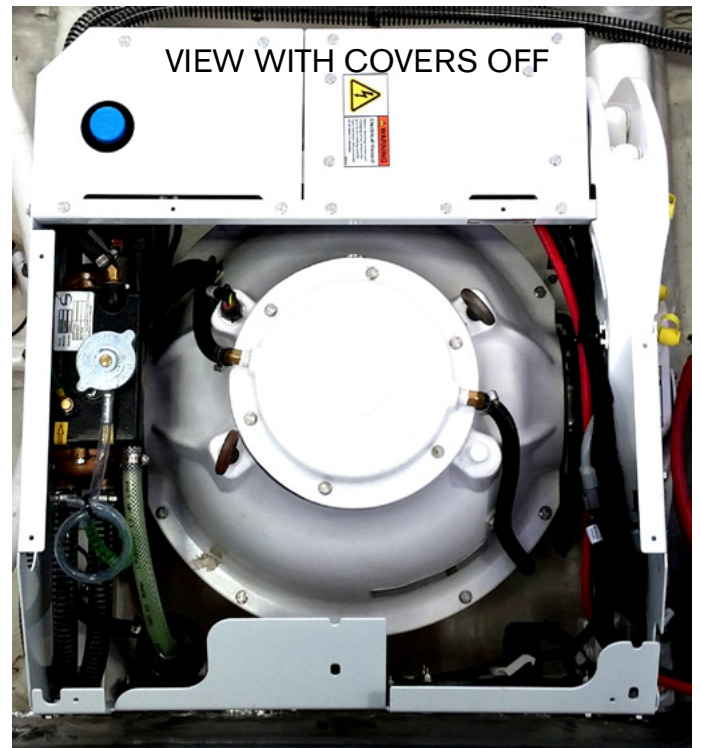

Side Dive/Boarding Doors (Typical)

The side boarding (dive) doors feature a 316 gauge heavy duty stainless steel hinge and latching system. It provides easy access for various mooring situations.



DOOR IN CLOSED/LATCHED POSITION

To open a boarding door from the inside press the center lock button inward while pushing the latch handle down which will release the latch from the receiver plate. See the above photo.

To close the boarding door push inward and hold the center lock button and lift the handle up until it enters the receiver plate. Release the lock button. Check to ensure the door is locked.

The door swings inward and features a magnetic stop. The doors shall be closed and latched when underway! See warning label on this page.



DOOR IN OPEN POSITION



WARNING

AVOID INJURY OR DEATH
FROM FALLING OVERBOARD!
ENSURE DOORS ARE CLOSED
AND LATCHED WHEN UNDERWAY!

Stereo/Entertainment



Fusion Stereo

Introduction

Your Fusion stereo is part of the Apollo family which makes it simple to customize your audio entertainment and speakers for superior sound quality in any area of your vessel. A selection of Fusion technology features are found below. **Refer to your Fusion owner's manual for complete operating instructions.**

The Fusion stereo unit installed in your vessel is designed and engineered for the harsh marine environment. Head units are globally IPX5 rated against water ingress. When you leave your boat after a cruise weekend you can count on all selections being saved through a stereo memory system featured on your vessel, even with the main battery switch turned off.

Regal offers durable marine speakers and optional speaker LED lighting for ambiance.

The unit offers independent control of your audio entertainment including balance, sub woofer, and volume level from multiple audio zones as part of the optional stereo performance package.

The stereo features Fusion-Link™ an entertainment integration process which permits **Fusion to be displayed and controlled on your Garmin chart plotter using a NMEA 2000 network which communicates with each component.**

Features

Digital Sound Processing (DSP)- A technically superior listening experience using precisely calculated loudness curves optimized for the human ear ensure quality, full range audio at every volume level with distortion controls in place.

Party Bus*- A system of additional enabled stereos that gives you the option of joining Party Mode and play the same synced audio source through your entire vessel. You can go into Personal Mode and listen to available audio sources from your stereo in area of your choice without disrupting Party Mode in other sectors of the boat.

**Note that PartyBus and over the air software updates require the integration of an external network router or Apollo RA 770 stereo which may be available on line or from a Fusion dealer.*





Over-The-Air Software Updates- Available from your smartphone or compatible device through the free Fusion-Link app.



More Source Options- Bluetooth, UPnP, Optical Audio, advanced SiriusXM features and DAB + radio available, AM/FM radio, AUX and USB connections are readily available.

Advanced SiriusXM features (USA Only): Includes Instant Replay, TuneStart, TuneMix, SportFlash, along with Artist, Song and Game Alerts.

Note that a SiriusXM subscription and tuner are required to access SiriusXM satellite radio (available in USA only) DAB + radio requires the addition of an MS-DAB100A module (sold separately).

Stereo/Entertainment (Con't)

Button	Function
Dial	<ul style="list-style-type: none"> Turn to adjust the volume. <ul style="list-style-type: none"> When adjusting the volume, press to switch between zones. When adjusting the volume, press and hold for at least one second to adjust the subwoofer levels. Turn to move through the menus or adjust a setting. When in a menu, press to select the highlighted option. On a screen with tabs, press and hold for at least one second to open the other tab, such as the PARTYBUS tab.
	<ul style="list-style-type: none"> Press to turn on the stereo. Press to mute and un-mute the audio. Press and hold to turn off the stereo.
	<ul style="list-style-type: none"> Press to open the menu. Press to return to the previous screen from the menu. Press and hold to exit the menu.
	<ul style="list-style-type: none"> Press to change the source. Press and hold to open the PARTYBUS menu.
	<ul style="list-style-type: none"> Press to skip to the beginning of the track or to the previous track, when using an applicable source. Press and hold to rewind the track, when using an applicable source. AM, FM, or SiriusXM (in Live Mode) source: <ul style="list-style-type: none"> Press to tune to the previous station or preset. Press and hold for faster tuning (manual mode only). SiriusXM (in Replay Mode) source: <ul style="list-style-type: none"> Press to skip to the previous track. Press and hold to rewind the current track. DAB source: <ul style="list-style-type: none"> Press to return to the previous DAB station in the ensemble. When you reach the beginning of the current ensemble, the stereo automatically changes to the last available station in the previous ensemble. Press and hold to change the ensemble.

	<ul style="list-style-type: none"> Press to pause or resume media playback. AM/FM: <ul style="list-style-type: none"> Press to cycle through the tuning modes (auto, manual, and presets). Press and hold to save the selected station as a preset. SiriusXM source: <ul style="list-style-type: none"> Press and hold to switch between Replay Mode and Live Mode. In Live Mode, press to cycle through the tuning modes (manual, category, and presets). In Replay Mode, press to pause and play. DAB source: press to scan for DAB stations.
	<ul style="list-style-type: none"> Press to skip to the next track, when using an applicable source. Press and hold to fast-forward the track, when using an applicable source. AM, FM, or SiriusXM (in Live Mode) source: <ul style="list-style-type: none"> Press to tune to the next station or preset. Press and hold for faster tuning (manual mode only). SiriusXM (in Replay Mode) source: <ul style="list-style-type: none"> Press to skip to the next track, if applicable. Press and hold to fast-forward the current track, if applicable. DAB source: <ul style="list-style-type: none"> Press to advance to the next DAB station in the ensemble. When you reach the end of the current ensemble, the stereo automatically changes to the first available station in the next ensemble. Press and hold to change the ensemble.

Stereo Screen

The information displayed on the screen varies depending on the source selected. This example shows the device playing a track on a device connected using Bluetooth® wireless technology.



①	Source
②	Network status (<i>Network Status Icons</i> , page 11)
③	Album art (if available from a compatible source)
④	Track details
⑤	Elapsed time, track duration, and the current track number out of the total number of tracks in the playlist (if available)

Selecting a Source

- 1 Select .
- 2 Turn the dial to highlight a source.
- 3 Press the dial to select the source.

NOTE: Some sources appear in the source selection screen when they are not connected to the stereo. The USB icon is red when a USB device or cable is not connected.

Activate the Garmin plotter screen to control the stereo display functions and features. In addition the system can be controlled by activating the Apollo unit at the passenger side of the cockpit.

More product information along with operation manuals can be downloaded at the following web address:

www.fusionentertainment.com/marine

See the troubleshooting chapter for system assistance or contact Fusion web-site.

Stereo/Entertainment NMEA 2000 Network

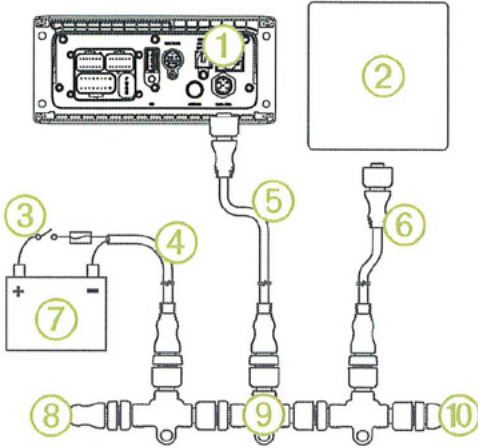

①	Stereo
②	Supported chartplotter MFD or compatible FUSION NMEA 2000 remote control
③	In-line switch
④	NMEA 2000 power cable
⑤	NMEA 2000 drop cable from the stereo, up to 6 m (20 ft.)
⑥	NMEA 2000 drop cable from the chartplotter MFD or compatible FUSION NMEA 2000 remote control
⑦	9 to 16 Vdc power supply
⑧	NMEA 2000 terminator or backbone cable
⑨	NMEA 2000 T-connector
⑩	NMEA 2000 terminator or backbone cable

Above is a typical NMEA 2000 network as used with the Apollo Fusion series entertainment package. Note the backbone to which all individual components including the Garmin plotter are connected to for communication purposes. The system uses 12 DC power and is protected by a fuse located under the dash inside the yellow sleeve connector. Note the terminator plugs on each end of the backbone. They must be intact for the backbone to operate efficiently.

Should the system stop working check the fuse, all backbone connections and the terminators for missing caps.

Note that a majority of the backbone can be accessed behind the Garmin starboard helm display. Also, check for proper system DC grounding. Ensure that system voltage is at 9 or higher as low battery voltage will effect NMEA 2000 operation.

Sunroof



The vessel features a retractable sunroof to catch your rays and to provide further cross ventilation. When closed the sunroof design of smoked acrylic protects from the direct rays of the sun but yet is translucent permitting constant sunlight To use pull the latch to desired opening. Be sure to close the sunroof when leaving the vessel for an extended period.

Sunshade System (Typical)



Manual bow and cockpit sunshades are available for your 38 SAV. The shades feature fiberglass poles, easy to use fastening system and durable Sunbrella canvas material. The poles are stowed at the gunnels. See photo below.



Note that instructions for use are found on the poles themselves.

Sunshade System Safety Tips/Notes

1. Do not use the sunshade system while making headway.
2. Do not pull the pole out further than the length shown.
3. Do not use the sunshade system when it rains.
4. The finish on the sunshade poles is carbon fiber which can conduct electricity. Caution must be used around power and lightning.
5. Always store poles in the gunnel storage clips.
6. Roll sunshades verses folding them.
7. Periodically clean sunshades and rinse until dry.
8. Prolonged exposure to sunlight may result in discoloration of poles.
9. Make sure the pole sockets installed in the deck are free of water which will promote rusting.

Read and understand the warning label and drawing adhered to the poles. There is a QR code on the pole label which can be scanned with your phone for the pole owner's manual.

Television/Entertainment (Con't)



The cockpit television drops down from the aft hard top ceiling locker. Up and down buttons are located on the starboard cockpit switch panel. Always position the TV before activating it. The television requires 120 volts AC.

To operate from shore do the following:

1. Install the coaxial cable between the shore and the vessel along with the dockside cord.
2. With ship's AC panel energized activate the entertainment breaker at the ship's main AC panel located in the cabin.

3. Use the remote and power up the television.

Note that the start-up television procedure just reviewed is for systems without KVH satellite TV.

KVH satellite television at sea start-up do the following:

1. Activate the entertainment breaker at the ship's main AC panel located in the cabin.

2. Activate the entertainment breaker on the DC panel located in the cabin as a portion of KVH system is 12 volts.

3. Push the ship's antenna button (B). This will power up the special antenna to receive satellite signals.

4. Power up the satellite receiver. Refer to the KVH owner's manual for further information.

One feature of the cockpit television is that with the plotter energized to a particular screen the skipper can display that screen at the television. Just choose HDMI 1 or HDMI 2 on the cockpit television remote.

All television coaxial splitters and the booster for the television mushroom antenna are behind the main ship's AC panel. **With the shore power disconnected at the vessel inlet** access can be found by removing the phillips panel screws.

TV SYSTEM COMPONENTS/WIRING

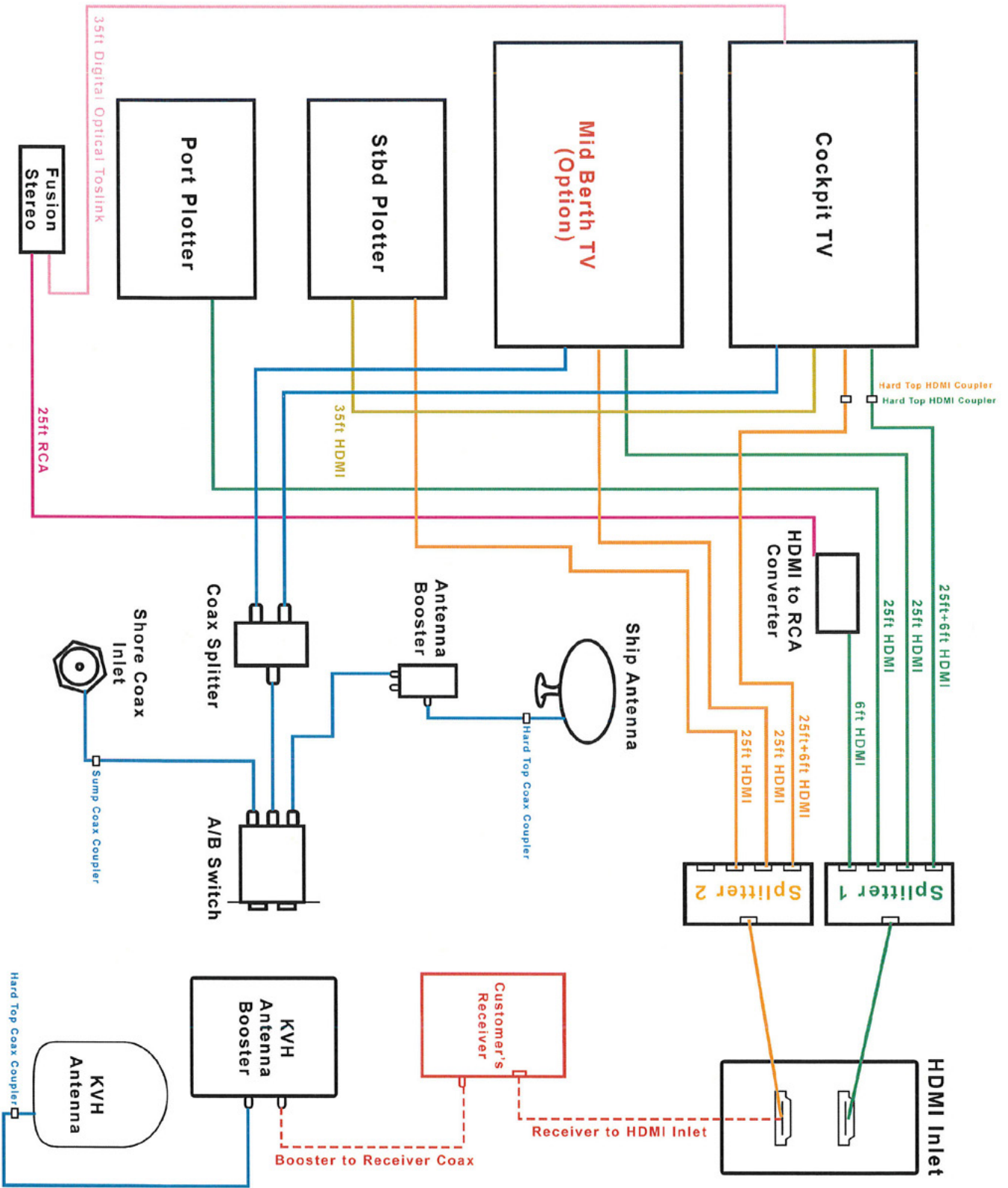

Television/Entertainment (Con't)

If installed the mid-berth television requires 120 volts AC. The entertainment breaker on the AC portion of the ship's master cabin panel controls the mid-berth television. Therefore, it must be on to view the mid berth television. Follow the same procedure as the cockpit television.

Television Antenna Switch

The television antenna switch (sometimes called the A-B switch) is located above the monitor panel in the cabin close to the ship's main AC panel. The purpose of the antenna switch is two fold:

At sea- Press the ships antenna or B button. This permits the mushroom television antenna installed on the hard top to find possible TV stations through the use of the antenna and its booster. *Note that in some circumstances you may not be able to receive any type of signal.*

At shore- Press the shore button (A). Now you are using a land signal brought through your coaxial cable.



MID BERTH TELEVISION



HDMI PLUGS



TELEVISION ANTENNA SWITCH

Note for further system information regarding the TV antenna wiring or HDMI's and related component wiring refer to the drawing on page 194 of this manual.

Television/Entertainment (Con't) HDMI

In the salon cabinet at the bottom of the cabin entrance steps are a series of shelves. These shelves are available for various electronic components if installed including KVH TracVision television receiver and Dish/Direct TV satellite box. They are normally placed on the smaller top and bottom shelves leaving the center shelf open. This arrangement permits you to install an electronic component such as a gaming device or BluRay player on the center shelf with a HDMI input and AC outlet.

Of course without any Satellite television the first and second shelves both have a HDMI input and AC outlet available. See photos below.

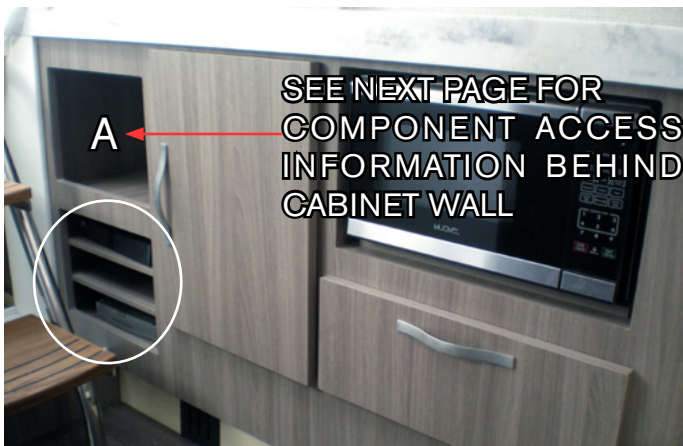

Photo at lower right shows center shelf along with HDMI input and AC outlet. **See next page for accessing components behind cabinet.**

Television/Entertainment (Con't) HDMI

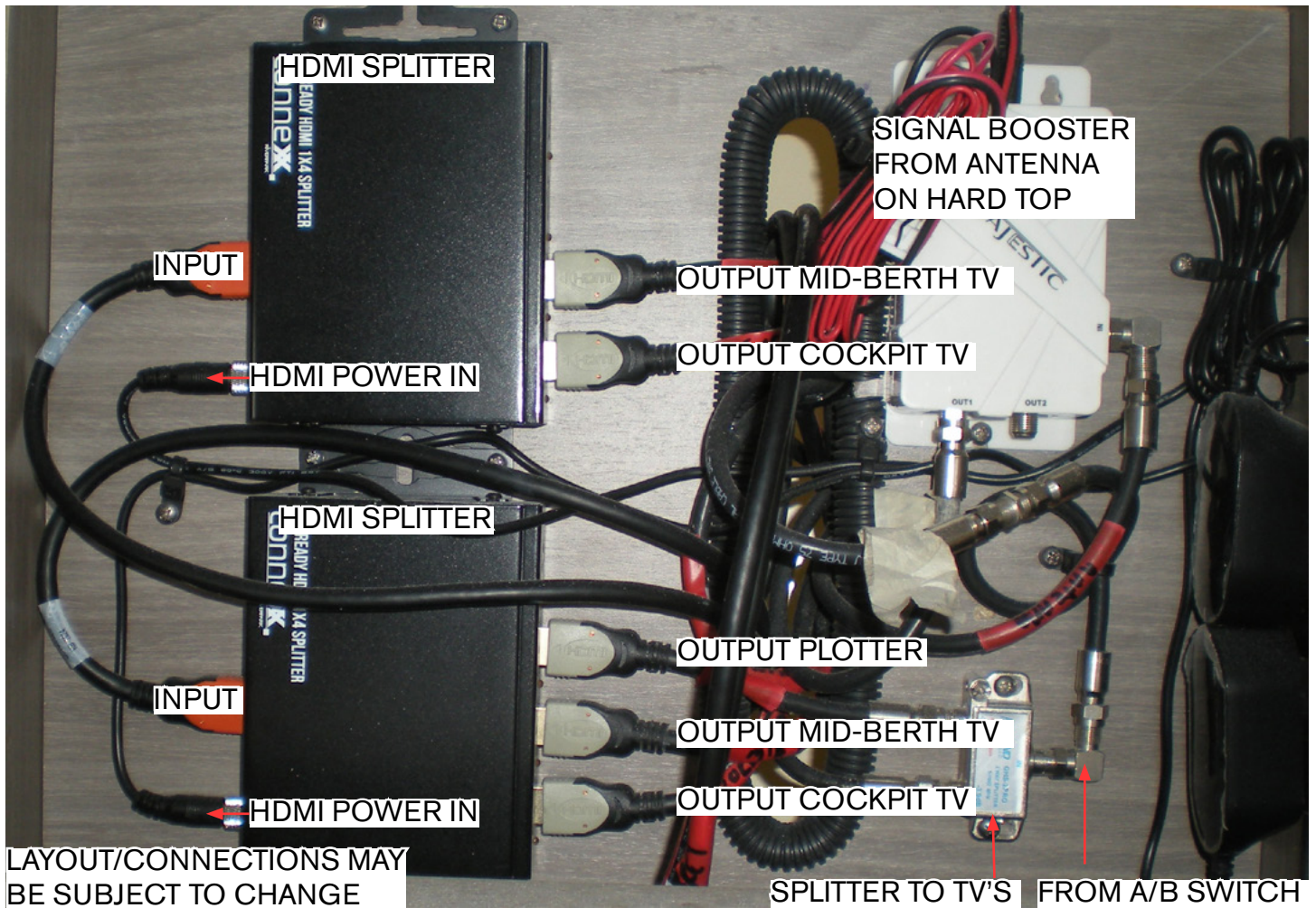

Photo above shows the electronic components shown on previous page inside cabinet access marked A.

To access components remove screws on cabinet wall on rear face and the cabinet wall behind A will flip down displaying the above A/V components.

Transom Doors

The aft port and starboard transom doors provide access to the swim platform and may be useful in certain mooring situations by providing easier access while disembarking.



To open the transom door pull the latch mechanism up to release.

To close the transom door push the latch mechanism down completely to engage the latch and lock mechanism.



WARNING

AVOID INJURY OR DEATH FROM FALLING
OVERBOARD!
ENSURE THAT TRANSOM DOOR IS
SECURED WHILE MAKING HEADWAY.

Trim Tabs

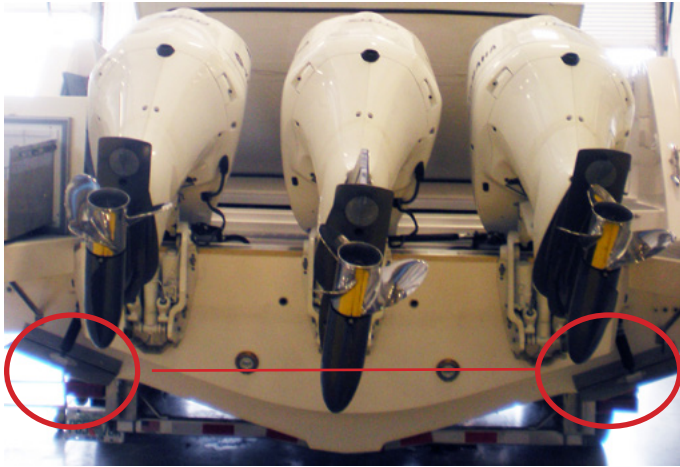

If installed, trim tabs are located on the lower hull of the transom. Water is deflected and redirected as the trim tabs are raised and lowered from the starboard helm located

trim tab switch. This change in water flow creates upper pressure under the tabs, and raises the stern. When the stern rises the bow is lowered. Lowering the port tab will cause the port stern to rise, making the starboard bow lower. Lowering the starboard tab will cause the starboard stern to rise, making the port bow lower. The pressure originates from a pump and valve system at the aft bilge.

When used with the engine power trim a fine tuned ride can be achieved. The trim tabs will compensate for uneven weight distribution, listing, water conditions, and other factors that cause inefficient operation. Remember, that trim tabs are trimming the hull while power trim is trimming the outboard(s) drives.

Obtaining A Trimmed Position

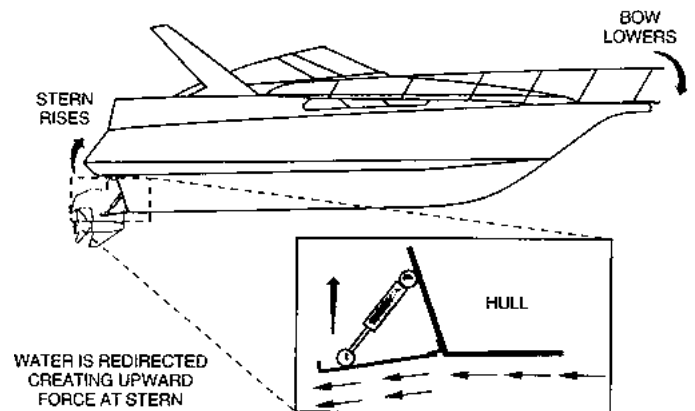

Your vessel will reach a planing position at a specific speed. This speed is determined by bottom design, weight distribution, water conditions, and on board equipment. As the throttle is advanced the stern squats and the bow rises initially. The trim tabs allow your boat to plane at a slower speed than natural conditions allow. *Note a stern drive example above.* In short bursts both trim tab rocker switches are pushed simultaneously in the “bow down” position which causes the trim tabs to move down. As the boat breaks over the bow high attitude the boat speed accelerates and visibility increases.

If the boat is over-trimmed, it will plow the bow and the boat will lose maneuverability. If this occurs, simply short burst the “bow up” trim tab rocker switches simultaneously.

In the “learning curve” process, press the tab switches in half second bursts. You will notice a slight delay from the time the switches are pushed until the boat reacts depending on vessel speed. You will know after awhile the optimum planing angle and speed.

When running in heavy seas press the “bow down” position which will assist the vessel to cut through the waves. This will produce a drier and more comfortable ride. In a following sea run the tabs in a fully retracted angle for maximum drive response. Sometimes you can watch the bow spray or stern wake and the rooster tail (mound of water produced by outboards). In a bow up position the spray is far aft to the hull, the wake is high and the rooster tail is high.

When trimmed or in the bow down position, the bow spray is farther forward, the wake and rooster tail are smaller, and positioned further behind the vessel. Also, when trimmed you will notice that tachometers show an increase in rpm’s.

Rectifying A List

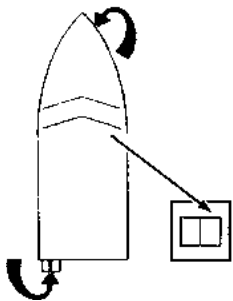

Your vessel can use the trim tabs to rectify a list. The trim tabs adjust the boat’s attitude in the direction the helm rocker switch is pushed.

If the port bow is high, push the left-hand “bow down” direction on the dash rocker and the port bow will lower. If the starboard bow is high, push the right-hand “bow down” direction and the starboard bow is lowered.

Using Outboard Power Trim With Trim Tabs

TRIM TABS WITH POWER TRIM

- Trim Tabs Trim Hull
- Power Trim Trims Prop

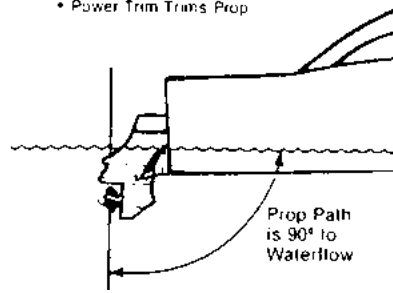

Adjust the trim tabs to achieve a planing attitude. Use the power trim to position the prop path parallel to the water flow. At this point the trim tabs

may need a fine adjustment.

One advantage of the trim tab system is that they allow trimming of the hull while the power trim results in trimming the props.

Note that Illustration shows stern drives vs. outboard drive units.



The indicator lights display the relative position of both port and starboard tabs at all times.

Underwater Lights

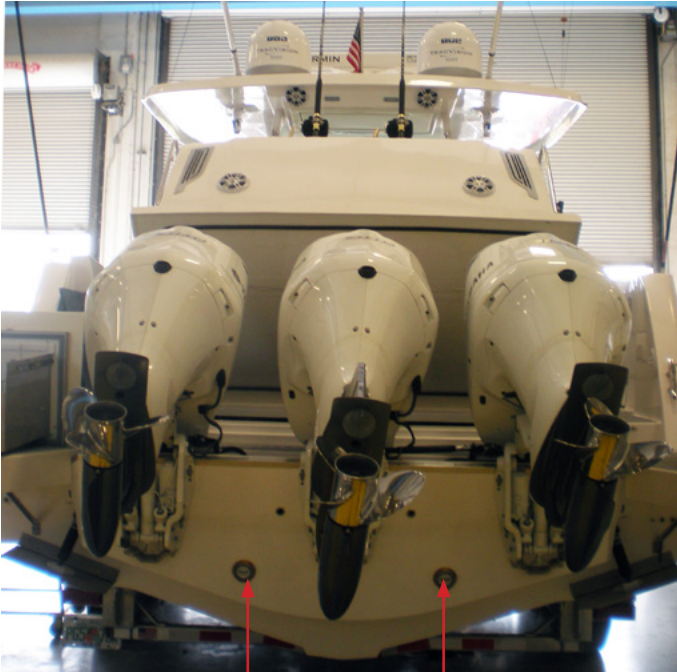

Dome shaped blue LED clusters make up the underwater lighting system. The lights are located on the transom along with the port and starboard hull sides. There is a dash switch for energizing the lights and a breaker under the dash to protect the system.

Windshield Wiper

Windshield wipers are installed on your vessel. These wipers feature a planographic design which keeps constant pressure on the wiper blade to ensure a more efficient removal of water on each sweep.

The wiper switch features continuous low and high speed positions including 6 intermittent delay intervals ranging from 3-18 seconds. Also, the switch incorporates an LED night light indicator.

Note that windshield damage may result if the wiper blade is run over a dry windshield.

Periodically check the wiper blades for excessive wear and replace the wiper blades as needed. It is always a good idea in rain prone environments and areas of high seas to store an extra set of wiper blades on board.

When you press the “wash button” below the wiper icon on the wiper switch fresh water from the potable tank is pumped through the wiper housing and onto the windshield. This cycle is triggered by a solenoid located near the wiper motors under the headliner.

Chapter 8

Care & Maintenance

Cosmetic Care

This section covers the care and maintenance of your Regal boat. Many cosmetic care topics including exterior hardware, upholstery, fiberglass and canvas are covered along with major equipment and systems. Refer to the owner's information packet and the appropriate outboard engine manufacturer's manuals for further detailed instructions.

Upholstery

Cockpit and interior vinyl require periodic cleaning to maintain a neat appearance and to prevent the build up of dirt, mildew and contaminants that may stain and reduce the vinyl life if they are not removed. The frequency of cleaning depends on the amount of use and conditions to which the vinyl is subjected. Most common stains can be cleaned using warm, soapy water and clear rinses. Scrubbing with a soft bristle brush will help loosen soiled material from embossed surfaces and under welting. If the stains are not removed with the above method use a mild cleaner such as Fantastic. This cleaner should be used only as needed and not the normal means. With more stubborn stains, rubbing alcohol or mineral spirits may be tried cautiously. Widespread solvent use can severely damage or discolor vinyl. Try to remove stains immediately before they have a chance to penetrate the surface of the vinyl. *Note to see the common stain chart at the end of the care section (page 222).*

Powdered abrasives, steel wool, or industrial strength cleaners are not recommended for cleaning our vinyl. Lacquer solvents will cause immediate damage. Dilute chlorine bleach before using. Do not wax the vinyl as it may cause cracking. Always wear protective gloves and make sure there is sufficient ventilation when cleaning vinyl. Wear eye protection.

Remember that suntan oil will damage vinyl. Use suntan lotion instead of suntan oil. Exposure to the sun is a natural enemy of vinyl upholstery. Keep the vessel covered with a cockpit cover when not in use.

Cockpit Carpet

Use approved cleaners on carpet. Always try on a test area first. Many spots and spills can be removed using a cleaner combined with a clean, white terry towel. Try not to soak an area excessively and do not use solvents because most interior carpet is rubber backed and glued in place. Solvents and abrasives will break down the backing and fibers. *Note:* Always roll up cockpit carpet before towing your boat. Store carpet in a locker.

Plastic

Use plastic cleaners and polishes recommended for marine use only. Use proper applicators. Read all instructions carefully. Test the product in a small area first. Use a soft rag and always rinse the surface with water. Ammonia based cleaners and abrasives will damage plastic parts.

Acrylics

The companionway door is one item made from a heavy acrylic material. Use warm water and a couple drops of mild detergent, The cleaning rag should be lint free and thoroughly rinsed. Do not substitute paper towels, which could lead to fine scratching of the surface. With the right cleaning materials, you can easily remove most dust and grime without creating an additional static discharge.

Do not use an abrasive or scouring pad. Acrylic must not be exposed to organic, oil-based solvents.

This includes:

- Acetone/nail polish remover
- Paint thinner or comparable
- Benzene
- Rubbing, denatured, or other alcohol-based solutions
- Carbon tetrachloride

For scratches and other marks that do not respond to basic cleaning, polishing is the way to renew your acrylic. Again, use a soft, lint-free cloth. You can hand polish or use a polishing machine.

Apply the polish in a snake like S pattern across the surface first horizontally and then vertically. Smaller polish jobs can use an L shape followed by a circular motion. If you are still not able to remove the blemish the scratch is probably too deep. In these situations, the only recourse is an incremental wet sanding, finishing with an #800 grit abrasive, and another coat of polish. After polishing any residual polish should be removed.

NOTICE

AVOID CLEANING PLASTIC SURFACES WITH A DRY CLOTH OR GLASS CLEANING SOLUTIONS CONTAINING AMMONIA. NEVER USE SOLVENTS OR WIPE WITH ABRASIVES.

Interior Fabrics

Clean flat good interior fabrics with dry cleaning fluid style cleaners approved for use with soft fabrics. Allow adequate ventilation and follow the label instructions carefully. Use a soft cleanser with feldspar to clean stubborn marks or stains on wallpaper. Normal interior vinyl such as used on the headliner on cruisers and head clean up with a mild soap and water solution. Rinse immediately with clean water and wipe dry. Always test an area with a cleaner before applying it to a larger area.

Fiberglass & Gel Coat

 **DANGER**

AVOID SERIOUS INJURY!
WAXED GELCOAT SURFACES CAN BE VERY SLIPPERY! DO NOT WAX NORMALLY USED AREAS OF THE DECK, LINER, OR GUNWALES. DO NOT WAX ANY TEXTURED OR NONSKID SURFACES SUCH AS FLOORS, WALKWAYS, STEPS, LADDERS, OR SWIM PLATFORMS. WEAR NON-SLIP FOOTWEAR WHEN WALKING ON VESSEL SURFACES!

NOTICE

WIRE BRUSHES, SCOURING PADS, OR OTHER ABRASIVE TYPE MATERIALS AND SOLUTIONS SHOULD NEVER BE USED ON THE HULL OR DECK. THEY CREATE SMALL SCRATCH THAT COLLECT MARINE GROWTH.

Routine maintenance is the only practical way to keep the surface of your boat looking shiny and new. Most objects left outdoors will gradually deteriorate from exposure to the sun, water, dust and pollution. Such outdoor exposure can cause your boat's gel coated surface to change or fade. Darker colors tend to fade more rapidly than lighter colors because they absorb more of the sun's rays (ultra-violet and infrared).

Basic maintenance includes monthly washing of the boat's surface to remove normal accumulation of soil and stain.

Use a mild detergent such as dishwasher powder or liquid. Do not use automatic dishwasher detergent. Avoid any kind of alkaline cleaners such as trisodium phosphate (TSP), abrasives, bleaches and ammonia. For best results use cleaners that are recommended for fiberglass.

It is recommended that you wax the gel coat surface twice yearly to prevent loss of gloss and to protect the finish. Use only waxes for fiberglass and follow the label instructions. Apply a 3' x 3' section at a time using clean applicator cloths or a buffing bonnet. When a haze develops, use a power buffer at low speeds (1200-2000 rpm) to remove the haze. Keep the buffer moving to avoid heat buildup. The power buffer is very efficient at removing contaminants from gel coat. Never wax gel coat in the direct sun.

When the washing and waxing as recommended does not restore the shine it may be necessary to use a fine rubbing compound. Do not apply rubbing compound in direct sunlight. A power buffer at low speed does an excellent job to remove impurities from the gel coat that cause dulling. Use light pressure and keep the buffer moving. Re-wax after compounding to buff the surface.

“Hairline cracks” or “spider webbing” could develop in the gelcoat surface of a hull or deck. This can be caused by impact or other factors. Small air pockets or gouges may also occur through normal wear.

These do not affect the strength of the hull or deck and can be repaired by yourself, a marine professional or a Regal dealer.

The affected area should be chipped or sanded away and a thin layer of color matched gel coat applied. This layer is then sanded smooth and buffed to its original luster.

Most minor scratches, nicks, and dents can be removed by compounding the surface. Marine type compounds can be found at most auto body supply stores. Specify a number 25 which is a coarser compound up to a number 55 being less coarse. Various glazes and polishes are available as needed. Ask your marine professional or Regal dealer for more information. Fiberglass hulls are strong but they can be damaged. A fiberglass hull has virtually no internal stresses. Thus when a part is broken or punctured, the rest of the hull retains its original shape. A severe blow will either be absorbed or result in a definite localized break. A break of this nature should be checked and repaired by a marine professional or a Regal dealer.

Minor Repairs

You will need the following materials for minor repairs:

- Gel coat
- Clear Liquid Catalyst
- Putty Knife
- Razor Blade
- Fine Sandpaper (400,600,1000)
- Wax Paper (to cover repair area)

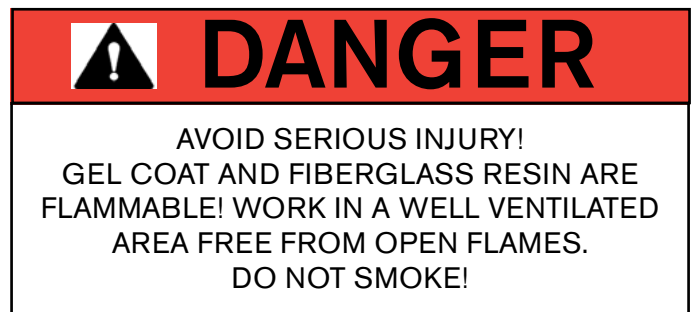

For minor repairs refer to the following procedure:

1. Clean the area to be repaired and get rid of any wax or grease residues.
2. Clean out scratches, chips, and nicks.
3. Sand area to be repaired so gel coat will bond.
4. In a separate container, measure only the amount of gel coat you will need. Mix a ratio of 2% ratio of catalyst to the amount of gel coat being used (a spoonful of gel coat will require only a drop or two of catalyst). Do not pour any unused portions of the gel coat/catalyst mixture back into either original container.

5. Apply gel coat to area leaving a slight lift above the surface.

6. Cover the area with wax paper. It will help the mixture to set up faster.

7. Remove wax paper and shave off any extra gel coat with a razor blade.

8. After the area is shaved smooth, start with the 400, 600, and finally 1000 grit sand papers.

9. Buff the area with compound, polish and a finish wax. You may notice a difference between the repaired area and the original finish due to the natural weathering process.

Canvas

Boat canvas is in most cases subjected to more severe punishment than practically any other type of material. Moisture, dirt and chemicals from industrial fallout, heat, ultraviolet rays and salt water are all factors which accelerate the deterioration of your boat canvas. These elements can cause serious damage if left unchecked.

The boat top and other canvas supplied on your Regal boat are manufactured from top quality materials to provide you with years of trouble free service. The following information on the care, cleaning and proper storage of the fabrics and fasteners that make up your marine canvas is being provided to help you maintain the appearance and ease of operation.

Sunbrella General Information

Sunbrella is used on bow and aft manual sun shades (if installed). Sunbrella is a woven fabric made from 100% solution dyed acrylic fiber. It is color fast and will withstand long term exposure to the sun (ultra-violet rays) without excessive fading.

Even though it is treated with water repellency some "misting" through the fabric is typical. With new canvas, the greatest potential for leakage is through any sewn seams. Because Sunbrella and the long term thread used is synthetic, the holes created by sewing will not swell up and seal when exposed to water as cotton does. Usually the movement of the fabric in use will move the fibers enough to seal the holes. You may apply Apeal or Uniseal to the seams to speed up this process.

When the canvas is new, the fit will normally be tight. It is designed this way because Sunbrella stretches as it ages, The initial tight fit allows for a suitable fit for the life of the canvas. The Sunbrella fit will vary slightly in the heat, cold, and rain.

Sunbrella Cleaning Instructions

Sunbrella canvas should be cleaned regularly before substances such as dirt, roof particles, etc., are allowed to accumulate on and become embedded in the fabric. The fabric can be cleaned without being removed from the boat. Simply brush off any loose dirt, hose down, and clean with a mild solution of natural soap in lukewarm water. Rinse thoroughly to remove soap. **DO NOT USE DETERGENTS!** Allow to air dry.

For heavily soiled fabric, remove the top from the frame.

Soak the fabric in a solution that has been mixed to the following proportions.: 1/2 cup of bleach and 1/4 cup of Ivory or Lux soap (liquid or soap) per each gallon of lukewarm water. Allow the fabric to soak until the bleach has killed the mildew and the stains can be brushed out with a common kitchen scrub brush. Rinse the fabric thoroughly in cold water to remove all the soap. This may require several rinsings. Incomplete rinsing can cause deterioration of sewing threads and prohibit the fabric from being properly retreated. Allow the fabric to dry completely. **DO NOT STEAM PRESS OR DRY IN AN ELECTRIC OR GAS DRYER!** Excessive heat can damage and shrink the fabric since it is heat sensitive.

This method of cleaning may remove part of the water and stain repellent that was applied to the fabric during its manufacture. It is recommended to retreat with such water repellency products as Apseal and Uniseal. We do not recommend any wax based treatments such as Thompson's Water Seal or any of the silicone products such as SC-15 or Aqua-Tite. Wax based products prevent the fabric from breathing, and encourage mildew growth while the silicone products interact with the original fluorocarbon finish and seem to cause a rapid loss of water repellency.

Clear Vinyl, Zipper & Snap Care

Never store canvas wet or in an unventilated, moist area. Always roll the canvas instead of folding. This is of particular importance on side curtains or any other part with the clear vinyl "glass". Roll the top carefully around the bows and cover with the storage boot provided.

The clear vinyl "glass" used in side curtains, aft curtains, visors, and camper enclosures is very susceptible to heat and cold. Keep vinyl curtains from touching metal tubing to minimize burning the vinyl. If the boat is stored with top, side curtains and aft curtain in place, heat build up inside the boat may discolor the vinyl. To clean the clear "vinyl" glass, use a solution of Ivory or Lux soap, liquid or flakes, and lukewarm water. Allow to air dry. Never use any type of abrasive cleaner as it will scratch the "vinyl" glass. There are many cleaners and scratch removers on the market specifically for clear vinyl. Handle the clear curtains carefully. They are soft and prone to scratching.

Canvas parts are designed with zippers. When zippers are new they can be a little difficult to use. Zip carefully without forcing the zipper or the material. They will loosen with use. A zipper lubricant may be used to help new zippers as well as maintaining used ones. The most vulnerable part of the zipper is the starts. Use care when beginning to close the zipper.

Canvas snap fasteners should be unsnapped as close to the button as possible. Never remove canvas by pulling roughly on the edge of the material. This can damage the canvas as well as the fasteners. Use petroleum jelly on snaps to keep them from developing corrosion especially in harsh environments.

Metal

Keep all stainless steel and other metal parts rinsed and wiped dry. To maintain their finish annually polish the stainless steel and other bright works at least annually. Use commercially available metal products and read the labels carefully before use.

Refer to the flyer in the owners information pouch.
 Most marinas and boating retail outlets carry metal care products.

Hull Bottom

Never use wire brushes or highly abrasive scouring pads on your hull bottom. It could damage the gel coat surface or the bottom paint. The bottom of your boat needs to be clean since the build up of natural coatings from water or marine life can potentially create drag and affect your boat's performance.

FREQUENT STAINS/CLEAN-UP STEPS	1	2	3
Coffee, Tea, Chocolate.....	B		
Permanent Marker*.....	E	B	C
Household Dirt.....	A	B	
Grease.....	D	B	
Ketchup, Tomato Products.....	A	B	
Latex Paint.....	A	B	
Oil Base Paint.....	D	B	
Mustard.....	A	B	C
Suntan Oil.....	A	B	
Asphalt/Road Tar.....	D	B	
Crayon.....	D	B	
Engine Oil.....	B		
Spray Paint.....	B		
Chewing Gum.....	D	A	
Shoe Polish*.....	D	B	
Ballpoint Pen*.....	E	B	A
Lipstick.....	A	B	
Eyeshadow.....	E	B	
Mildew*.....	C	B	A
Wet Leaves *.....	C	B	A

- A= Soft brush; warm soapy water/rinse/ dry
- B= Fantastik cleaner
- C= One tablespoon ammonia, 1/4 cup of hydrogen peroxide, 3/4 cup of warm water/ rinse/dry
- D= Scrape off residue (use ice to lift gum)
- E= Denatured alcohol/rinse/dry
- * These products contain dyes which leave permanent stains.

Battery



Frequently check your battery terminals for corrosion build-up. If you find a greenish, powdery substance, remove the cable connections and clean

both the both the terminals and the connectors with a wire brush. When the cleaning is finished reconnect the battery cables and coat the terminal with an approved grease or petroleum jelly to help prevent further corrosion.

Check the electrolyte level at least every 30 days, more often in hot weather. The level should be maintained between the top of the battery plates and the bottom of the fill cap opening.

Add distilled water as needed after charging the batteries or periodically as needed. Do not over-fill because sulfuric acid could run over and cause burns or an explosion.

Batteries should be charged outside the boat. Do not smoke or bring flames near a battery that is being or has recently been charged. The hydrogen gas generated by battery charging is highly explosive. Set batteries on a block of wood rather than concrete since this procedure will help the batteries from losing their charge.

Do not allow a metal object or loose wires to spark across battery posts while working close to the battery. Contact across terminals will cause a short circuit and personal injury may result.

Tighten all battery connectors securely. Check their tightness by pulling on the connectors. They should not move from their tightened position. Be sure to reinstall the positive boot over the battery terminal after tightening the battery post connection. While using the boat, use the volt meter to monitor the charge level of the battery. Monitor the charge with the engines turned off (static condition).

The engine alternators recharge the batteries. A fully charged battery will indicate between 12.3 and 12.6 volts on the voltmeter. Readings below this could indicate a dead battery cell or a charging system malfunction which should be checked by a marine professional.



WARNING

AVOID SERIOUS INJURY!

BATTERIES CONTAIN SULFURIC ACID (POISON) WHICH ALSO CAN CAUSE BURNS. AVOID CONTACT WITH THE SKIN, EYES, AND CLOTHING. IF CONTACTED, FLUSH WITH WATER FOR AT LEAST 15 MINUTES. IF SWALLOWED, DRINK LARGE AMOUNTS OF WATER, OR MILK. FOLLOW UP WITH MILK OF MAGNESIA, BEATEN EGG, OR VEGETABLE OIL. GET MEDICAL ATTENTION IMMEDIATELY!



WARNING

AVOID SERIOUS INJURY!

WEAR GOGGLES, RUBBER GLOVES, AND A PROTECTIVE APRON WHEN WORKING WITH A BATTERY. BATTERY ELECTROLYTE CAUSES SEVERE EYE DAMAGE AND SKIN BURNS. IN CASE OF SPILLAGE, WASH AREA WITH A SOLUTION OF BAKING SODA AND WATER.

Dockside Cords

1. GENERAL INFORMATION

To minimize shock and fire hazards:

- a) Turn off the boat's shore connection switch before connecting or disconnecting shore cable.
- b) Connect shore power cable at the boat first.
- c) If polarity warning indicator is activated, immediately disconnect cable.
- d) Disconnect shore power cable at shore outlet first.
- e) Close shore power inlet cover tightly.
- f) **DO NOT ALTER SHORE POWER CABLE CONNECTORS**

2. STORAGE

This cable set is intended for use outdoors. To prolong the life of the cable set, store under cover where not exposed to sunlight or weather when not in use.

3. PREVENTIVE MAINTENANCE

Most boat owners are faithful in the care and maintenance required to insure their boat's beauty and sea-worthiness. However, they often overlook the maintenance of its "dockside life support system" — the AC shore power system.

The boat's shore power inlet, cable set and adapters, and the dockside receptacle require a minimal amount of time and effort to inspect and maintain. Doing so can prevent power interruptions to the conveniences supplied as original equipment or those added later. There are a few basic checks, but before performing any maintenance on these items, make sure you turn off the boat's main shore power switch and disconnect the cable set from the dockside power source.

The metallic parts of marine wiring devices are made to resist corrosion. In a salt water environment, the life span of the devices can be increased by periodically rinsing the exposed parts in clean water, drying them completely and spraying them with a moisture repellent before using the devices again. This process should especially be followed if either the boatside or dockside connector is ever accidentally immersed in salt water. It is imperative that all salt water or brackish water be cleaned from a device before reusing it. A common cause of failure is the result of contamination on a device in one of two forms. The first is contamination of the device's contacts (with corrosion, dirt, etc.) which impedes the flow of electricity, leading to overheating and possible failure. The other type is contamination (salt, water, etc.) of the face of the device which allows current to flow across an insulating surface causing a short circuit.

This brings up a common but often misunderstood problem — the "bad plug/bad receptacle syndrome". The basis of the problem is that if a bad device is mated to a good one, then the good device can be rendered inoperative.

A high-resistance connection can be made between the contaminated contacts on the bad device and its mating contacts on the good device.

Many people think a problem like this occurs because the connected devices cannot carry their rated current load. This is not true. The overheating results from the current passing through a poor connection. This high-resistance connection gradually degrades as arcing occurs and "pits" the contacts which adds to the problem. This type of connection can heat up to a point where the metal contacts melt away and the insulating body burns. If you ever experience this problem to any degree, make sure both devices are replaced. If only one device is replaced, the other bad device will cause the process to be repeated.

The key to the situation is inspection. Periodically check all device exposed contacts for "pitting", burn or "flash" marks, or signs of deterioration/discoloring of the plastic. If any of these conditions exist, there is an indication of poor contact or high resistance connections and the devices should be replaced. When docking at a marina other than your home berth, it is a good idea to check for a bad receptacle by feeling the plug after 15 minutes and again after an hour. If the plug feels uncomfortably warm to the touch, a bad connection is indicated. Contact the dockmaster immediately.

The third common cause of failure in dockside power devices is the result of the mechanical abuse of devices. If the exposed contacts of the plug are misaligned due to abuse (such as being bent when dropped, stepped on, or run over) and are not realigned before connecting to the mating device, the contacts on the mating device can be distorted and possibly fail. Making sure that exposed male contacts are in the same position as they were when new will prolong the life of mating devices.

One final area of concern is the appearance of the yellow vinyl jacketed cable on dockside power cable sets and adapters. A soiled cable can be cleaned with a grease cutting household detergent or a good vinyl cleaner. A periodic application of a vinyl protector will help the cable keep its original appearance.

WARNING: This product contains chemicals, including lead, known to the state of California to cause birth defects or other reproductive harm.

Wash hands after handling.

Fuel System

At least annually inspect all fuel system components for loose clamps at the vent, fill and feed locations. Examine each hose for signs of deterioration and leakage. Check the fuel sender for loose bolts, nuts, and leaks at all areas of contact. Also, inspect the fuel tank for signs of leakage or abrasion. Tighten all components as needed.



WARNING

AVOID SERIOUS INJURY OR DEATH DUE TO
FIRE OR EXPLOSION RESULTING FROM
LEAKING FUEL!
INSPECT ENTIRE FUEL SYSTEM
AT LEAST ONCE PER YEAR.

Galvanic Corrosion/Stray Current

Metal parts underwater can be subjected to two basic styles of electrolysis: galvanic corrosion and stray current corrosion. Both can damage the outboard drive, propeller, underwater parts, boat and motor if not correctly monitored (testing at 2 week intervals) and avoided.

Galvanic corrosion is an electrochemical reaction between two or more metals. Drive systems consist of several different metals. Some are more active than others.

Galvanic corrosion of the more chemically active metals can occur whenever two or more dissimilar metals that are “grounded” (connected by actually touching each other, or through a wire or metal part) are immersed in a conductive solution (any material that can conduct electricity). Anything but pure water is conductive. Saltwater, fresh water with a high mineral content and polluted freshwater are highly conductive. Conductivity increases with temperature. That is why Florida boats experience more corrosion than boats in Maine.

Specifically look at a typical outboard marine drive unit with a stainless steel propeller. The aluminum is the more chemically active metal (called the anode) and the stainless steel propeller is the less chemically active metal (called the cathode).

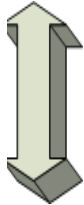
CORROSION TABLE	
Gold	 <p>Least Active</p> <p>Most Active</p>
Stainless Steel	
Bronze	
Copper	
Brass	
Steel	
Aluminum	
Zinc	
Magnesium	

Typically electrons flow from the anode (the aluminum drive unit), via the external conducting path to the cathode (stainless steel propeller). If there is a very large anode connected to a small cathode, the anode will corrode very slowly. If a very large cathode is connected to a small anode, the anode will corrode very quickly. Obviously, if you do not control galvanic corrosion, over time the aluminum will corrode away.

The first sign of galvanic corrosion is paint blistering (starting on sharp edges) below the water line- a white powdery substance forms on the exposed metal areas. As the corrosion advances, the exposed metal will become deeply pitted as the metal is actually eaten away.

Another condition which will increase galvanic corrosion is the removal or reduction in surface area of the sacrificial anodes. Never add aftermarket products that are connected to the engine ground such as stainless steel steering aids and trim planes. Zinc connected to aluminum will form a corrosion cell but the aluminum (drive) becomes the cathode and the zinc (anode) corrodes.

Even though your boat may not have shore power aboard current from nearby vessels with shore power can produce stray current galvanic corrosion. Stray current corrosion occurs when metal with an electrical current flowing into it is immersed in water that is grounded (lake, ocean, pond). The current can leave the metal and flow through the water to ground. This will cause rapid corrosion of the metal at the point where the current leaves.

When a vessel nearby is plugged into shore power, they can potentially tie your outboard drive unit to their boat via the green grounding shore power lead. Your outboard drive unit could be the receiving end of a large galvanic cell (a battery) interconnected with nearby vessels or even through the marina's metal structures via their electrical system.

The vessel should be tested every couple of weeks to determine the integrity of the anode protection system. Another way to test the system is to measure the hull potential. This is accomplished by immersing a reference electrode, usually a silver/silver chloride into the water about six inches behind the outboard drive. With leads attached to a digital multi-meter the hull potential is read on the DC scale and compared to recommended specifications for the water body type. See the owner's information vendor packet for more information or contact your nearest authorized Regal dealer.

Tips To Aid In Maintaining Galvanic Integrity

1. Test the galvanic integrity of your vessel every 2 weeks. Raise the drive and inspect anodes/parts for signs of galvanic corrosion, stray current corrosion or loose fasteners. Contact your closest Regal dealer/marine professional where signs of galvanic corrosion exist.
2. Never paint over anodes as they will become inoperative. Always leave at least one inch between bottom paint and any underwater fitting such as sea cocks, swim platform stanchions and all drive and propulsion related underwater parts.

3. Periodically remove vessel from water and clean/pressure wash all outboard, anode and hull bottom areas to remove growth.

4. Ensure vessel is using the correct anode metal for the body of water that it is moored. See the outboard engine manufacturer's manual for more information or contact an authorized dealer.

5. Ensure that the drive is completely "in" down to provide more complete anode protection when vessel is moored.

6. Do not attempt to use magnesium anodes in saltwater. They will provide over protection.

7. If marina moored, contact appropriate personnel if signs of galvanic corrosion appear on your drive system. Ask them to check for stray electrical current which may be originating from a nearby vessel's faulty DC wiring or from a marina pier, piling or dock carrying leaking marina ground wiring such as a dock side cord partially submerged.

GALVANIC/STRAY CURRENT CORROSION	
Cause/Observed Condition	Corrective Action
Sacrificial anodes consumed	Replace anodes when 30% consumed
Sacrificial anodes not grounded to drive	Remove anodes, clean contact surface, reinstall, check for continuity
Loss of continuity between underwater parts & ground	Provide good ground connections
Nearby vessel with stray current	Contact appropriate personnel Remove your vessel from water
Paint on drive heavily worn, exposing more metal	Prime and repaint or install additional anodes
Sacrificial anodes painted	Remove paint or replace anodes
Drive tilted/anodes out of water	Leave drive down, install additional anodes below water
Power trim cylinders only corroded	Provide a good ground to drive, all parts must be grounded
Corrosion in area of exhaust outlets	Remove deposits
Corrosion occurring after vessel is removed from saltwater	Wash exterior and flush interior with freshwater
Stainless steel parts corroding	Clean parts, remove foreign material, ensure continuity
Underwater drive parts corroded, sacrificial anodes OK	Oxide film on anode (fresh water only) Replace anode Poor ground. Scrape anode

Zinc Anodes

Sacrificial zinc anodes are located on the outboard drive housing, trim cylinders and/or prop shaft to protect softer metals exposed to the water. Electrolysis attacks the least noble metals first. Because zinc is a less noble metal, it will decompose before other metals. Check these zinc anodes periodically and have them replaced when they are 30% consumed. Notwithstanding, zinc is the most popular metal used to protect parts that are exposed to saltwater, freshwater or brackish water. See the photos below for anode location on your



outboard.

Zinc anodes in brackish or salt water need to be checked more frequently. If the anodes seem to be requiring frequent replacement there may be a boat leaking DC current into the water taxing the anodes.

This is especially possible around a marina environment. Contact a marine professional who can measure the galvanic activity with a special electrode and electric VOA meter. Refer to the engine manufacturer's manual for exact anode location and detailed information.

Inspect the ground leads for tightness if attached.

Note that parts damage due to galvanic or stray current corrosion is not covered under warranty.

Remote Control



Check the helm control box and make sure there is no roughness or tightness when shifting. Also, check to make sure the control box hardware is tightly secured. The

shifting is done by a process called “fly by wire” Being the engines use electronics to shift it should be effortless. An application of silicone spray on the handles will help fight any corrosion. Remember there are no actual mechanical shift and throttle control cables on your vessel. There is a friction control which may be altered to personal needs. Contact your closest Regal outboard dealer for further assistance or a marine professional.

Seating

Care of your seating includes periodic cleaning with products which are non-corrosive and are recommended for vinyl. Select seats use rams and hardware which needs to be periodically checked for tightness. See the cleaning vinyl section for more information.

Stereo

The Fusion® stereo head unit requires little maintenance. When washing the cockpit, do not discharge water directly at the stereo unit. Possible damage may result. As with any CD unit clean your CD's to keep them from skipping. This process also aids in keeping dust out of the unit. For further information, refer to your stereo owner's manual located in the owner's packet.

Outboard Engine Maintenance

A select portion of maintenance items are covered in this chapter. Since advanced ignition and fuel injection systems are used on outboard engines along with special factory training and tools it is best to contact your Regal dealer for more of the detailed outboard service procedures.



CAUTION

AVOID ENGINE DAMAGE!
FOLLOW ALL BREAK-IN PROCEDURES
RECOMMENDED BY THE ENGINE
MANUFACTURER. FAILURE TO FOLLOW
BREAK-IN PROCEDURES MAY VOID
THE OUTBOARD ENGINE WARRANTY.



CAUTION

AVOID ENGINE DAMAGE!
DO NOT RUN OUTBOARD ENGINE
AT A CONSTANT RPM FOR PROLONGED
PERIODS OF TIME DURING BREAK-IN
PERIOD. CHECK ENGINE OIL OFTEN.



CAUTION

AVOID ENGINE DAMAGE!
DO NOT RUN OUTBOARD ENGINE
OUT OF WATER UNLESS YOU USE
AN OPTIONAL FLUSHETTE.
FOLLOW MANUFACTURER'S ATTACHING
AND RUNNING INSTRUCTIONS!

Checking Engine Mounted Fuel Filter

As part of select outboards under the motor shroud (engine cover) on the lower port side of the outboard engine is a fuel filter. Periodically check to ensure the fuel filter is clean and free of water. When reinstalling the filter tighten to manufacturer's specifications. Check for leaks after starting the engine. For more information refer to the outboard manufacturer's owners manual or contact a Regal dealer or marine professional.



Checking 10 Micron Water Separator Filter



Periodically before embarking on a cruise check the fuel filters. A 10 micron in-line water separator filter for each engine is installed in the aft bilge. Use an oil spanner type wrench and turn the filter

counterclockwise to remove the element. With a clean pan empty the filter contents into the pan. Water in fuel tends to hug the bottom and will show a different color than the fuel. At least yearly or on an as needed basis replace the filter element. Fill the element up with fresh unleaded fuel of the correct octane rating and turn it clockwise until tight. Finish tightening with the spanner wrench. As always check for leaks before starting the engine.

It is a great idea to keep extra filter elements on board in protective wrap for emergency use.

Checking Engine Crankcase Oil

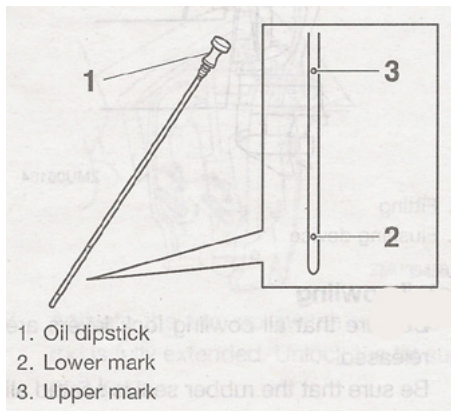

Your Yamaha outboard features 4 cycle engine operation. Unlike 2 cycle outboards which mix gas with oil

technology, the 4 cycle engine uses crankcase 4 cycle oil to lubricate internal moving parts. This operation is similar to automobile engine technology. As part of this process, there is a dipstick placed in the crankcase to offer periodic checking of engine crankcase oil.

To check the crankcase oil do the following:

1. Ensure the outboard is setting in a flat vertical position or the dipstick may not display an accurate oil level.
2. Remove the crankcase oil dipstick and wipe it clean.
3. Reinstall the crankcase oil dipstick completely into the hole. Remove it again.
4. The oil level should be between the upper and lower dipstick holes. .As needed add the manufacturer's recommended oil or contact your closest dealer especially if the oil is contaminated with water which will show a milky color verses a clear look. Refer to the outboard manufacturer's owners manual for oil changing maintenance schedules.

Checking/Filling Crankcase Oil- (Cont.)

When adding crankcase oil be sure to utilize the manufacturer's recommended type and viscosity. For changing crankcase oil contact your closest Regal dealer for additional information since they have the special tools and knowledge for these maintenance procedures.



Flushing Device

Your Yamaha outboard features a flushing device which when connected to a garden hose circulates fresh water through the engine to purge unwanted debris such as found in salty, brackish, and silty water.

To use open the flushing device by turning it counterclockwise. Notice there is a garden hose bib thread. Attach the male end of a garden hose to the fitting and tighten it. Make sure the fitting does not leak as the power head could overheat and cause internal damage. It is best to perform this flushing procedure with the engine still warm from a cruise as the thermostat will be open and will permit more efficient water circulation. Turn on the fresh water supply. When flushing completed remove the garden hose from the fitting and reattach the hose connections and of course check for tightness.

Note not to start engine during this procedure as overheating and engine damage may occur.

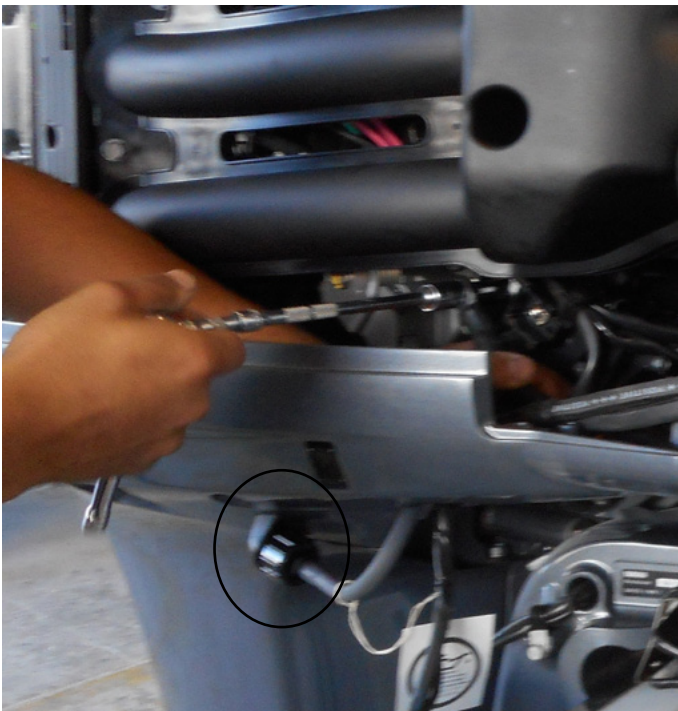

Fuses- Electric Cover Plate

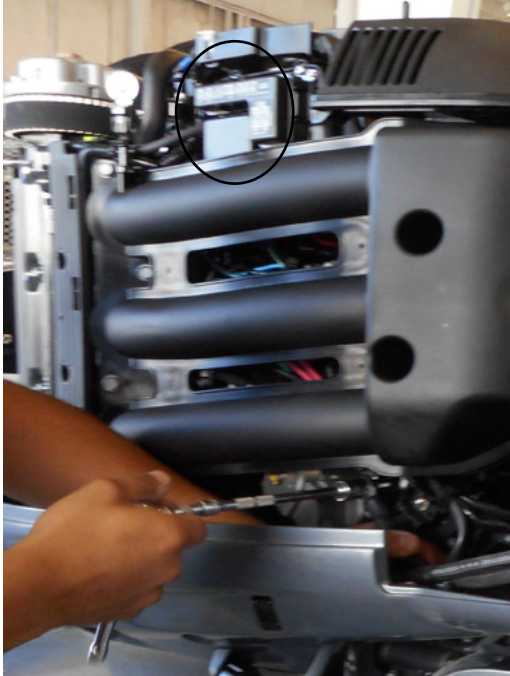

As part of
Yamaha
outboards
under the
motor
shroud
(engine
cover) on
the port
side of the
outboard
engine
is an
electrical
cover

plate. Inside this cover is a variety of fuses protecting various engine components. There are also extra fuses stored along with a fuse puller. For further information, refer to the manufacturer's outboard engine manual.

Propellers

Out-of-balance and nicked propellers will effect performance or cause vibration. Damaged props



should be replaced, but those that are chipped or bent can usually be reconditioned by a marine dealer or a

propeller repair facility. When cruising, consider carrying a spare set of props on board because many marinas do not carry a full inventory of replacement propellers. Also, carry an extra set of prop hardware. Refer to the outboard manufacturer's engine manual for appropriate propeller replacement.

Be sure to make a note of the propeller diameter and pitch while the vessel is in dry dock. They are pressed into the prop for easy reading.

Also, note that propellers feature a rubber hub pressed into the center propeller that includes the hole for the prop shaft to slide through. Sometimes as a result of impact the rubber hub becomes damaged and the propeller will not let the boat perform to the rated revolutions per minute (rpm).

In an emergency a stainless propeller blade may be straightened by laying the propeller blade on a 2 x 4 and hammering the bent portion of the blade until straight. The above process works better with a softer aluminum propeller.

It is advantageous to carry the needed tools to change propellers including pliers to pull cotter key and deep socket and ratchet to remove the propeller shaft nut. See the appropriate outboard manufacturer's owner's manual for further information.

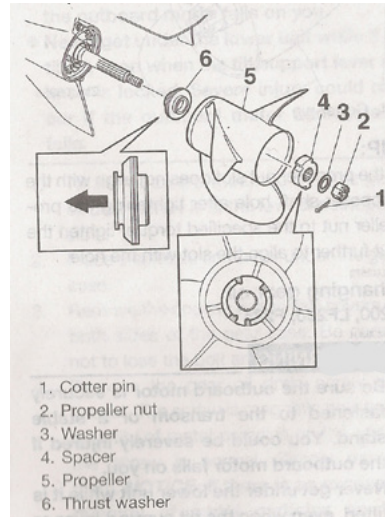

Removing the propeller- Before removing the propeller make sure the remote control is in neutral and the ignition keys are removed to prevent the outboard engine starting and possibly causing bodily injury.

Always wear gloves

when removing or installing propellers since the component blades are very sharp.

1. Use pliers to straighten the cotter key which will permit it to be pulled through the prop shaft.

2. Do not use your hand to hold the propeller while removing the nut.

3. Wedge a 2 x 4 between the skeg and the propeller. Then use a deep socket and ratchet to remove the propeller nut.

4. Next, remove the washer and spacer. Remove the propeller. Remove thrust washer and see note below.

Note: Check the prop shaft seal behind the propeller for fish line and debris that could cut prop shaft seal.

Installing propeller- Before installing parts back on to the prop shaft make sure you lubricate the prop shaft with the recommended lube.

1. Install the thrust washer on the prop shaft first as indicated in the illustration above. Then install the propeller.
2. Align the spacer protrusions with the cutouts of the propeller.
3. Install the spacer, washer, and propeller nut. Tighten the propeller nut to 40 foot pounds with a torque wrench.
4. Next, line up the protrusions on the spacer with the cut outs on the prop itself.
5. Align the propeller nut slot with the prop shaft hole.
6. Install a new cotter key and carefully bend the cotter pin ends over .

Note: Using an old cotter key increases the chances of the propeller working itself off the shaft since the cotter pin ends become stressed and weak after being bent over and constant engine vibration weakens the cotter key ends.

Note: If the prop shaft nut does not line up to insert the cotter key, tighten the nut to the point where it does line up with the prop shaft.

Chapter 9

Troubleshooting

The following diagnostic information will assist you in identifying minor electrical, fuel, and mechanical problems. Some of the items listed require technical training and tools. Additional assistance is available in the outboard engine manufacturer's owner's manual. Also, you can contact your closest Regal dealer or marine professional for more information.

Sometimes a problem can be solved by performing a logical sequence of elimination and/or root cause techniques.



WARNING

AVOID SERIOUS INJURY OR DEATH!
BEFORE PERFORMING ANY MAINTENANCE
WORK, TURN OFF THE BATTERY SWITCH
AND REMOVE THE IGNITION KEY
FROM THE SWITCH.



WARNING

AVOID SERIOUS INJURY OR DEATH!
USE ONLY APPROVED MARINE
REPLACEMENT PARTS THAT
ARE IGNITION PROTECTED.

OUTBOARD ENGINE DIAGNOSTIC CHART

Problem	Possible Cause
Engine Overheating	<p>Water pick-up feeds are blocked by debris</p> <p>Cooling system leak</p> <p>Impeller is worn or blocked by debris</p> <p>Propeller is over propped for the circumstances, causing the engine to work extra hard</p> <p>Debris in oil is holding heat more than normal - bad oil filter</p> <p>Defective thermostat.</p>
Starter Will Not Crank	<p>Battery weak or dead</p> <p>Starter defective</p> <p>Fuse for electric start relay blown</p> <p>Control not in neutral</p> <p>Defective start panel button</p>
Excessive Steering Play	<p>Air in steering lines (Bleed)</p> <p>System low on steering fluid</p> <p>Mechanical parts-loose connection</p>

OUTBOARD ENGINE DIAGNOSTIC CHART

Problem	Possible Cause
No Power To Helm	Battery switch turned off Batteries are weak or dead. Main breaker tripped Loose connection
Engine Cranks But Will Not Start	Fuel flow obstructed/water in fuel Low battery voltage Engine ignition system malfunction Timing belt broken No fuel in tank Safety lanyard not attached Control not in neutral
Hard Starting	Vacuum In Fuel System Fuel lines obstructed Water in fuel Debris in fuel/clogged fuel filter
Engine Idles/ Runs Rough	Old fuel Faulty spark plugs Fuel contaminated/ clogged anti-siphon

OUTBOARD ENGINE DIAGNOSTIC CHART

Problem	Possible Cause
Power Loss	Damaged propeller Improper trim angle Spark plugs fouled Fuel system malfunction Hull bottom fouled with debris Excess water in bilge (leak)
Excessive Vibration	Damaged propeller Damaged propeller shaft Loose/broken motor mount Steering pivot loose or damaged Debris caught on propeller Ignition malfunction Motor mount bolts loose (transom)

OUTBOARD ENGINE DIAGNOSTIC CHART

Problem	Possible Cause
Buzzer Sounds/Icon Lights	Cooling system malfunction Engine oil level low or incorrect type Wrong spark plug heat range Oil feed pump malfunction

DC ELECTRICAL SYSTEM DIAGNOSTIC CHART

Problem	Possible Cause
No 12 Volt Power At Battery	Battery switch turned off Weak or dead battery Battery cables loose/disconnected
Battery Not Charging While Engine Is Running	Faulty stator Faulty circuit wiring
Battery Will Not Hold Charge	Faulty/ old battery Loose battery cables Corroded battery terminals
12 Volt Equipment Not Working	Fuse blown-Take time to investigate why the equipment was drawing too much current or why it had a short circuit. Check fuses at fuse block and under the engine shroud Weak or dead battery if all 12 volt equipment fails to function. Corroded / loose wire connection Internal equipment short /failure

AC ELECTRICAL SYSTEM DIAGNOSTIC CHART

Problem	Possible Cause
No Voltage At Main AC Panel	Ships dock side cord not plugged in Dock side breaker tripped ELCI breaker tripped Faulty dock side power cord
AC Panel Indicates Reverse Polarity	Dockside wires reversed at marina power supply.
No Voltage At GFCI outlets	GFCI outlet tripped (reset) Outlet breaker off at AC main ship's panel Unplug faulty equipment-short
Main AC Panel Breakers Trip When All Equipment Is Energized	Turn off equipment as needed to balance load on shore 1 and shore 2

Chapter 10

Storage & Winterization

Storage procedures are outlined in this chapter. These are general guidelines to follow before longer periods such as over the winter in colder climates. Be sure to familiarize yourself with all relevant information in the owner's sacht.



TYPICAL VESSEL ABOVE SHOWING HULL SUPPORTED BY TRAILER

Special winterization procedures are necessary for the boat equipment and systems. Use the enclosed checklists to help you identify areas of concern and maintenance. Call a Regal dealer or marine professional for further information regarding storage/maintenance procedures. Also, more specific information can be found in the outboard engine manufacturers owners manual.



WARNING

AVOID SERIOUS INJURY OR DEATH
DUE TO FIRE AND EXPLOSION!
DO NOT FILL FUEL TANK TO RATED
CAPACITY. LEAVE ROOM FOR EXPANSION.

NOTICE

REMOVE BATTERIES WHEN VESSEL
IS IN LONG PERIODS OF STORAGE
ESPECIALLY IN COLD CLIMATES
BATTERIES CAN FREEZE AND POSSIBLY
LOSE ELECTROLYTE.

NOTICE

AVOID SERIOUS OUTBOARD ENGINE
DAMAGE! USE ONLY FACTORY APPROVED
PRODUCTS FOR OUTBOARD ENGINE AND
DRIVE DURING STORAGE PERIODS.



CAUTION

PREVENT STRUCTURAL HULL DAMAGE
FROM BLOCKING HULL!
NEVER BLOCK UP THE BOAT HULL.
SUPPORT VESSEL ON CRADLE
OR ADJUSTED TRAILER.
STRUCTURAL HULL DAMAGE FROM
BLOCKING IS NOT COVERED UNDER
REGAL WARRANTY!

Decommissioning Checklist

Outboard Engine Winterization/Maintenance

- Run engine. Pour approved fuel stabilizer/conditioner in the fuel tank. Allow time for it to circulate through the fuel system.
- Change all engine fluids as referenced in the outboard engine manufacturer's owners manual. Contact a Regal dealer.
- Check outboard engine hoses, clamps, and system wiring for loose connections, abrasion, and corrosion.
- Spray all exterior parts with a rust preventative.
 - Perform maintenance as referenced in the outboard manufacturer's owners manual. Contact your Regal dealer.
- Remove propeller. Refurbish as needed.

Outboard Engine Care

- After cleaning use touch up paint on unit as needed.
- Apply coat of wax to outboard shroud and exterior parts.

Boat

- Check hull bottom for any fiberglass damage.
- After cleaning apply a coat of wax to hull and deck surfaces.

- Pour a pint of 50/50 antifreeze into bilge pump.
- **Never block up boat bottom as structural damage may result which is not covered under Regal warranty.**

- Remove batteries. Use a trickle charger as needed.
- Remove all loose gear and electronics from boat. Inspect all equipment for wear and damage. Store in a clean, dry environment.
- Remove drain plug. Clean drain plug hole of debris as needed. Enclose drain plug in plastic bag and tie to steering wheel.
- Make sure bow is higher than stern to permit proper drainage.
- Clean all upholstery and store so it breathes.
- Conduct a visual inspection to ensure boat is balanced properly on the trailer, cradle or blocks.
- Cover boat with appropriate cover. Tie down for protection from rain, snow and/or wind. Prop up cover to provide proper ventilation. Do not cover up the fuel vents.
- Drain the fresh water system per instructions in this chapter.
- Use sling locations for lifting boat via Chapter 12 drawing.

Trailer

- Repack all wheel bearings per manufacturer's specifications.
- Check all trailer parts for excessive wear. Replace/ refurbish as needed.
- Use touch up paint on trailer as needed.

Typical Fresh Water System

1. Activate the fresh water pump switch.
2. Open all faucets including transom shower (if equipped) and allow tank to empty.
3. Drain the water tank. Shut off fresh water pump switch.
4. Mix nontoxic antifreeze with water in accordance with the manufacturer's recommendations. (Available at marina & RV stores)
5. Pour solution into the fresh water tank.
6. Turn on fresh water pump switch.
7. Open water faucet and purge until a steady stream of nontoxic antifreeze flows from the faucet. If equipped, do the same to the transom shower. Turn the fresh water switch to the "off" position.

Waste System

1. With chemical heads, make sure to dump both upper and lower tanks. Rinse well with fresh water. Sanitize chemical head as needed.
2. With electric head, pump out holding tank. Add nontoxic antifreeze to toilet and holding tank. Pump from toilet to holding tank to eliminate any water remaining in supply lines.

NOTICE

AVOID VESSEL AND/OR OUTBOARD ENGINE DAMAGE! CONTACT A MARINE PROFESSIONAL FOR WINTERIZATION ASSISTANCE. DAMAGE CAUSED BY IMPROPER WINTERIZATION IS NOT COVERED BY REGAL OR OUTBOARD ENGINE MANUFACTURER.

Recommissioning Checklist

Engine

- Check all components per outboard engine manufacturer's owner's manual especially fluid levels.
- Run engine on "ear muffs" (flushette) before launching. Check for fuel, exhaust, oil, and water leaks.

Boat

- Install drain plug.
- Install battery and tighten all terminals.
- Check all equipment, switches, alarms, gauges and breakers for proper operation.
- Add necessary chemicals and water to chemical head.
- Add water to fresh water tank. Turn on faucet to purge tank. Refill water tank.
- Make sure all safety gear is on board and in excellent working condition.
- After launching, check controls and gauges for proper operation.

Trailer

- Make sure all equipment is in excellent working condition.

Chapter 11

Glossary & Index

Below is a brief list of nautical terminology. For more detailed glossaries we recommend you check your local library, book retailer, marine store or internet.

Glossary

Abeam: at right angles to the fore and aft line and off the boat

Aboard: on or in the boat

Above:the part of the boat on a vessel which is above the interior of the boat

Aft, After: aft is the boat section toward the stern or back of the boat

Amidships: toward the center of the boat from either side to side or rear to front

Beam: the width of a boat at its widest part

Bilge: the lower interior of the hull of the boat

Bitter end: the end of a line also the end of an anchor line

Bow: the front, or forward part of the boat

Bulkhead: the vertical partition or wall of a boat

Cast off: to let go or release

Chine: the line fore and aft formed by the intersection of the side and bottom of the boat

Chock: deck fitting used to secure or guide anchor or tie lines

Cleat: deck fitting with protruding arms around which lines are secured

Cockpit: the seating space used to accommodate passengers

Cuddy: a small cabin in the fore part of the boat

Deck: the open flooring surface on which crew and passengers walk

Draft: the depth from the waterline of the boat to the lowest part of the boat, which indicates how much water is required to float the boat

FasTrac- a proven hull bottom design which incorporates a full, mid-beam step that reduces drag by forcing air under the hull to decrease drag and friction.

Fathom: a measurement of depth; one fathom equals six feet

Fender: a cushion hung from the side of a boat to prevent it from rubbing against a dock or against other boats.

Fend off: to push off to avoid sharp contact with dock or other vessel

Fore: the part of the boat toward the bow or front

Freeboard: the height of the top side from the waterline to the deck at its shortest point (The distance from sheer or gunwale to the water).

Gunwale: rail or upper edge of the side of the boat

Head: toilet

Hull: the part of the hull from the deck down

Keel: the lowest point of a boat; the backbone of the vessel

Knots: a measurement of speed indicating nautical miles per hour

Lee: the side opposite that from which the wind is blowing; the side sheltered from the wind

Leeward: the direction toward which the wind is blowing

PFD: personal flotation device; required for each person aboard

Port: the left side of the boat when facing forward (an easy way to remember the difference between "port" and "starboard" is that both "port" and "left" have four letters)

Shank: the main body of an anchor

Sheer: the curve of the boat's deck from fore to aft when seen from the side

Starboard: the right side of the boat when facing forward

Stern: the aft end of the boat

Stern drive: an inboard/outboard (I/O) unit

Stringer: strengthening integral unit fastened from fore to aft inside the hull and fiberglass encapsulated for added strength: much like the skeleton system of our body

Index

A

Accidents	40
Acrylics	217
All-Around Light	144
Anchor Light	32
	144
Anchor Windlass	177
Anchoring	138
Audible Alarms	118
Automatic Fire Extinguisher	54

B

Battery	60
	223
Battery Activation Panel	69
Battery Switch Panel (Remote Switches)	72
Battery Charger	78
Battery Switch	72
Bilge Pump	182
Boating Under The Influence	39
Bottom Blocking	248
Bow Table	183
Bow Thruster	184
Breaker Panel (DC)	67
Bridge Clearance	51
Buoys & Markers	49

C

California EVAP Regulation	2
California Spark Ignition Warranty Info	2
Canvas	220
Carbon Monoxide	36
Cardiopulmonary Resuscitation	175
Cockpit Sea grass Mat	191
Controls	156
	231

D

DC Distribution Panel	67
DC Hatch/TV Actuator Modules	66
Dealer Responsibilities	12
Decommissioning	248
Direct Current Protection	67
Distress Signals	30
Diver's Flag	42
Docking	168
Drain Plug	162

E

EPIRB	11
Electrical (DC)	56
Emergencies	174
Engine-Outboard Basics	136
Engine-Starting	154
Environmental Awareness	176
Exhaust	36

F		I	
Fenders	166	Ignition Panel/Switch	154
Fiberglass	218	Index	254
Filters	100	Instruments	143
	234	Interior Fabrics	218
Fire Extinguishers	27	Interrupter Switch (Safety Lanyard)	157
First Aid	175		
Fishing	42	K	
Float Plan	9	Knots	174
Fueling	163		
Fuel System	111	L	
	226	Labels (Safety)	18
		Ladder	22
		Lighting	82
G		Life Raft	35
GFCI	95	Loading	20
Galvanic Corrosion	227		21
Galvanic Isolator	97		261
Garbage Placard	34	Law Of Salvage	173
Gelcoat Maintenance	218	Lubrication-Engine/Gearcase	140
General Boating Safety	19		135
Getting Underway	162		
Glossary	252	M	
Grill	188	Maneuvering	166
		Maintaining PFD'S	26
H		Masthead Light	32
Helm Controls	142	Metal Cleaning	221
HIN	7	Minimum Required Equipment	35
Horn	35		
	144		
Hull Bottom	222		
	247		
Hypothermia	175		

N		S	
Navigational Aids	48	Safety Labels	18
Navigation Lights	31	SeaDek	199
Navigation Rules	46	Seating	20
Neutral Safety Switch	157		261
Night Running	51	Shallow Water Operation	171
		Shifting-Remote Control	156
O		Ship's Main AC Panel	64
Oil Spills	33	Signals-Navigation	45
Overloading	20	Sound Producing Devices	31
	21	Spring Line	165
Owner's Information Packet	7	Stopping	168
Owner's Registration	12	Stern Line	164
Owner's Responsibilities	12	Stereo	203
		Sunroof	205
P		T	
Personal Flotation Devices	24	Table Of Contents	5
Plastics	216	Tachometer	143
Pollution Regulations	34	Technical	258
Power Trim	169	Toilet	122
	214	Towing	173
Pre-departure questionnaire	162	Trim Angle	169
Propellers	141		213
	238	Trim Indicators	214
		Trim Tabs	169
R		Troubleshooting	240
Radio Communications	31	U	
Recommissioning	251	Underwater Lighting	215
Required Safety Equipment	35	Upholstery	216
Right Of Way	46		
Rules Of The Road	44		

V

Ventilation	99
Visual Distress Signals	30

W

Water Sports	42
Warranty	14
Weather	43
Windshield Wiper	247
Winterizing	198
Wiring Color Codes	56

Y

Yacht Plate	7
-------------	---

Z

Zinc Anodes	230
-------------	-----

Chapter 12

Technical

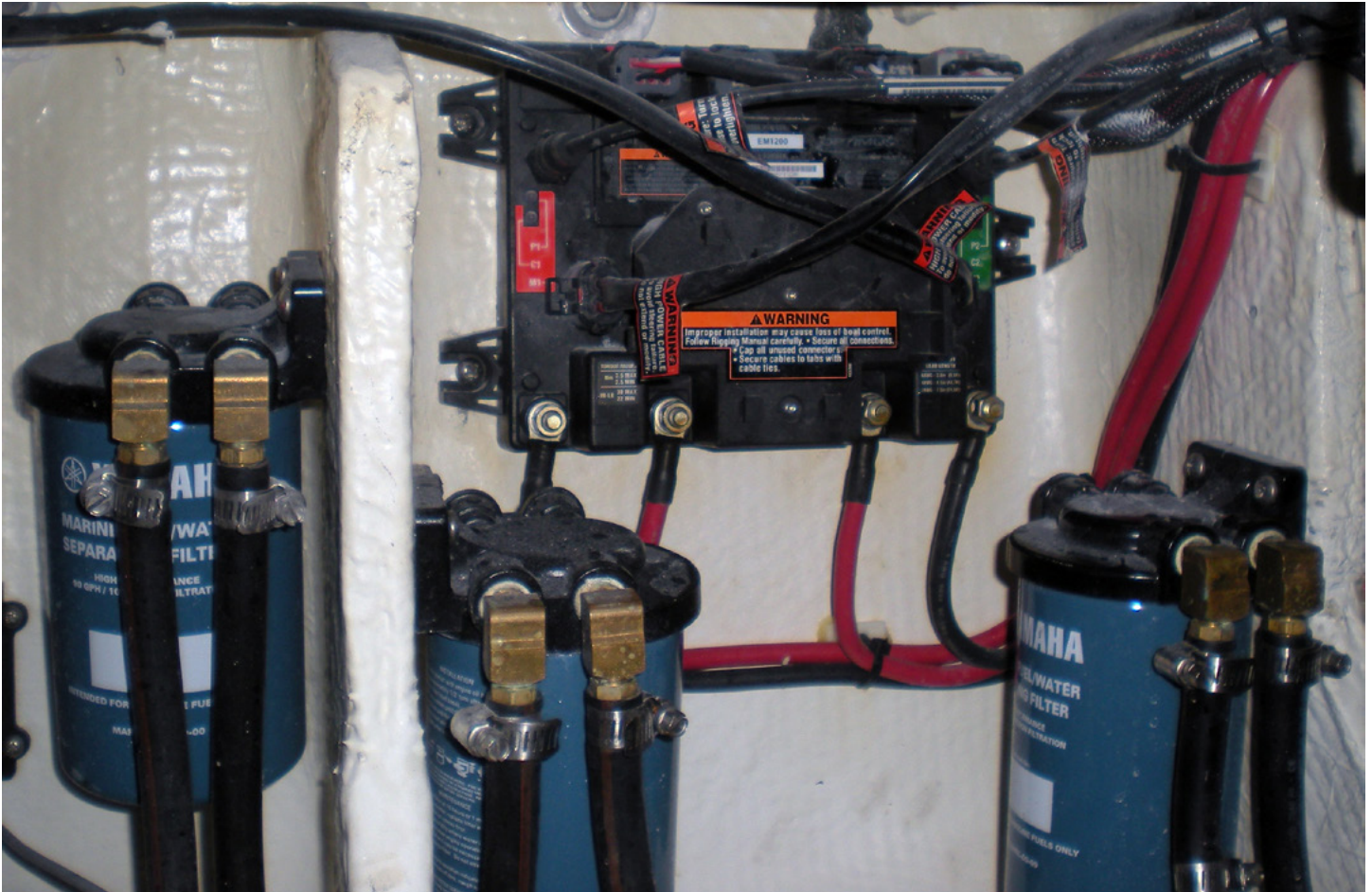

NOTICE

The following technical information and drawings can be an aid in troubleshooting electrical and mechanical problems along with the charts located in the troubleshooting chapter.

Note that all product specifications, models, standard and optional equipment, systems, along with technical information is subject to change without notice.

For more information contact your nearest authorized Regal dealer. For the location of your nearest authorized dealer call 407-851-4360 or visit the web-site at www.Regalboats.com.

Your Regal dealer has received special factory training on the entire product line and his services should be employed to solve technical problems.

GENERAL ARRANGEMENTS



REGAL MARINE AND COMPANY, INC. MAKING IS THE SOLE PROPERTY OF REGAL MARINE AND COMPANY, INC. ALL RIGHTS RESERVED. PHOTOGRAPHY BY DENNIS R. THOMAS

 REGAL MARINE INDUSTRIES 2000 W. 10th Street Ft. Lauderdale, FL 33304 TEL: 954.771.1111		ALL RIGHTS RESERVED	
DATE	8/12/2019	PAGES	1 OF 2
DESIGNED BY	TMH	APPROVED BY	Dennis R. Thomas
		TOTAL SHEETS	1

TOP VIEW



<p>REGAL MARINE INDUSTRIES 615 JACO T. LORAIN DRIVE TEL: 407.875.4000 ALL RIGHTS RESERVED</p>			
<p>REGAL MARINE INDUSTRIES 38 SAV (SV) General Arrangements</p>			
DATE:	6/12/2019	REVISED:	
DESIGNER:	TMH	APPROVED BY:	Dennis R.
		TABLE:	2 OF 2
		FIG. NO.:	2
<p>NOT NEARLY AND COMPLETELY. THE INFORMATION CONTAINED IN THIS DRAWING IS THE SOLE PROPERTY OF REGAL MARINE INDUSTRIES. NO PART OF THIS DRAWING IS TO BE REPRODUCED OR TRANSMITTED IN ANY FORM OR BY ANY MEANS, ELECTRONIC OR MECHANICAL, INCLUDING PHOTOCOPYING, RECORDING, OR BY ANY INFORMATION STORAGE AND RETRIEVAL SYSTEM, WITHOUT THE WRITTEN PERMISSION OF REGAL MARINE INDUSTRIES. © 2019 TMH</p>			

DOMESTIC SEATING OCCUPANCY

15.5" W X 29.5" L
Allowance Per Person

Seating Occupancy: 15 Persons

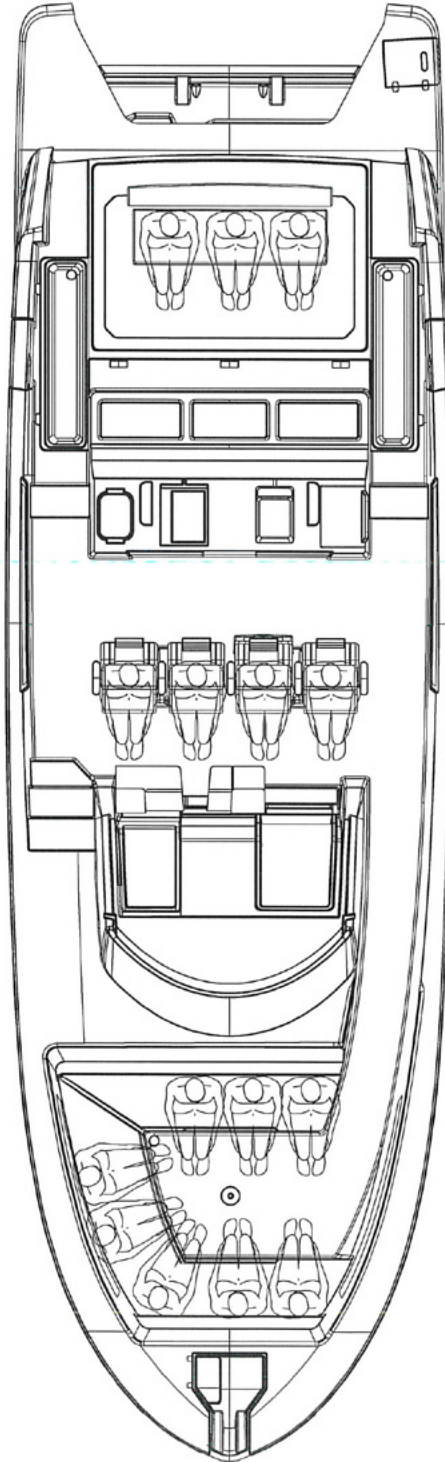

REGAL MARINE AND COMPANY, INC. IS NOT RESPONSIBLE FOR THE SEATING CAPACITY OR WEIGHT LIMITS OF THIS VESSEL. ALWAYS FOLLOW THE MANUFACTURER'S RECOMMENDATIONS FOR SEATING CAPACITY AND WEIGHT LIMITS. ALWAYS WEAR YOUR SEATBELT AND PLEASE DON'T DRINK AND DRIVE.

 REGAL MARINE INDUSTRIES 2000 W. 10th Street Fort Lauderdale, FL 33304 954.343.7000 ALL RIGHTS RESERVED			
DATE	6/12/2019	PAGE	1 OF 1
DRAWN BY	TMH	APPROVED BY	Dennis R.
38 SAV (SV) Seating Capacity		DATE	3

SLING LOCATIONS FOR LIFTING

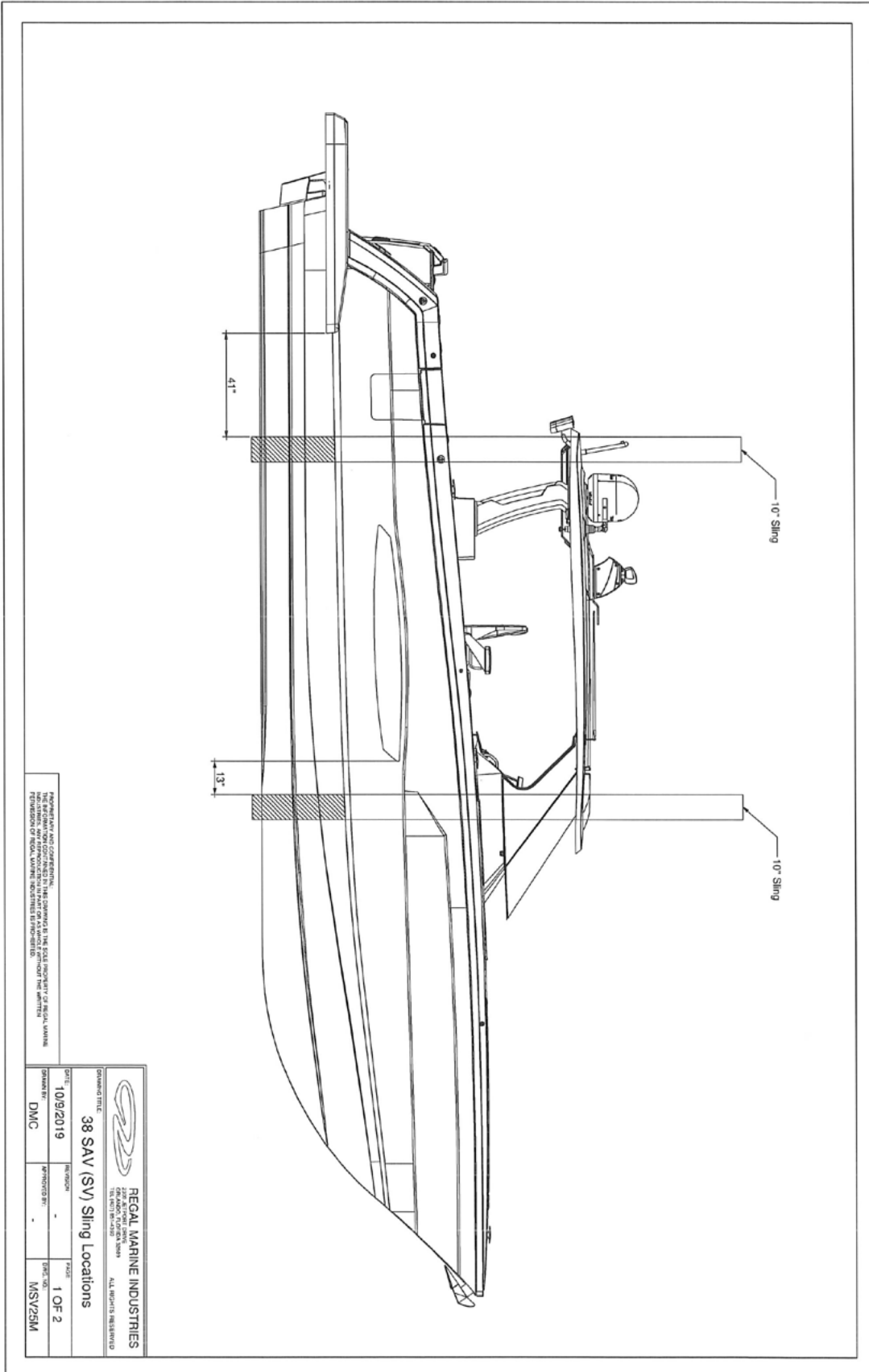

TYPICAL DOMESTIC (EPA) COMPLIANT GASOLINE FUEL SYSTEM COMPONENTS

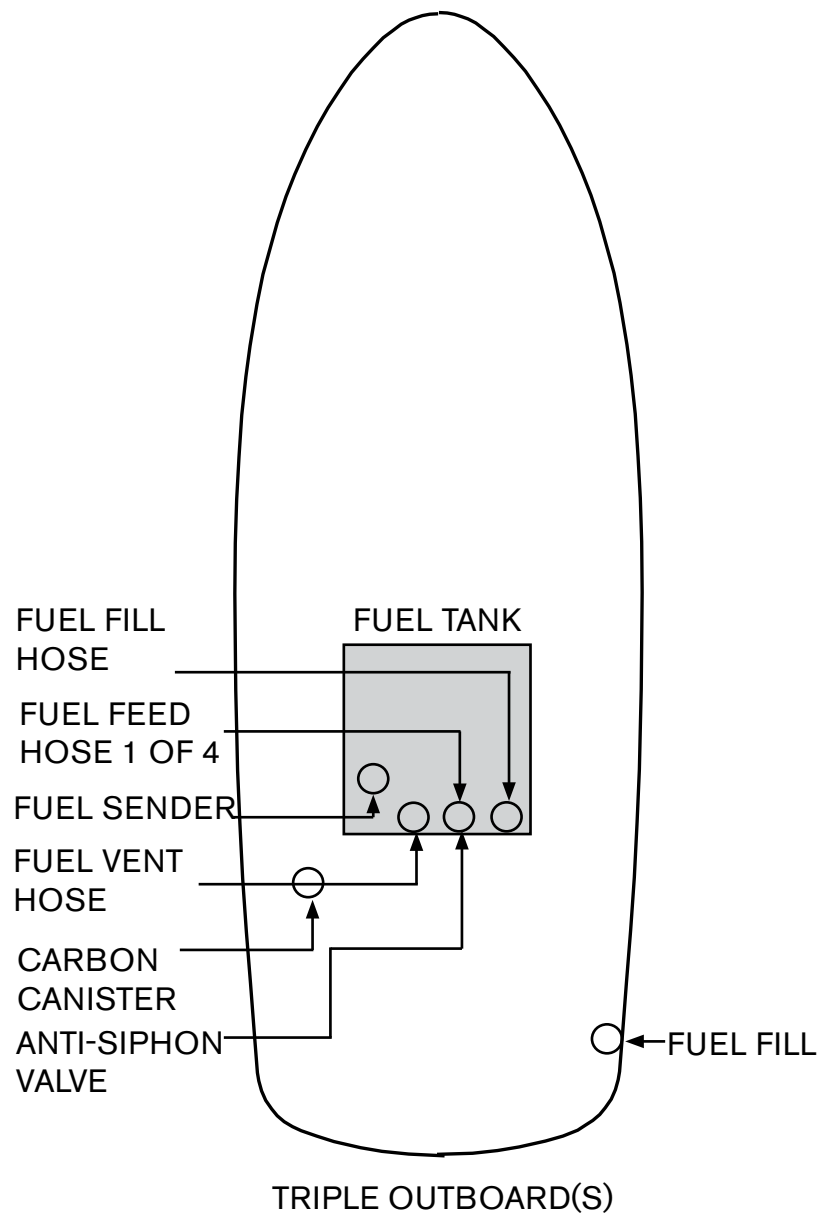

* NOTE THAT ABOVE PETRO TANK FEATURES 3 ENGINE FUEL FEEDS & 1 GENERATOR FEED

TYPICAL LABELS & LOCATIONS

WARNING
USE PROPER BLOCKING TECHNIQUES
WHEN LIFTING BOAT

NOTICE
Retrieval of Windlass Chain
Winch operator may be required
to periodically spread chain out
within anchor locker



CAUTION
AVOID POSSIBLE BODILY INJURY
OR DEATH DUE TO FALLING.
THE STARBOARD BOARDING STEPS
ARE FOR EMERGENCY ONLY.
USE HAND HOLDS.
DO NOT OCCUPY OR USE
BOARDING STEPS WHEN UNDERWAY!



WARNING
AVOID SERIOUS INJURY OR DEATH
FROM FIRE OR EXPLOSION
RESULTING FROM LEAKING FUEL.
INSPECT SYSTEM FOR LEAKS AT
LEAST ONCE A YEAR.

WARNING
Electrical shock and fire hazard. Failure
to follow these instructions may result in
injury or death.
(1) Turn off the boat's shore power
connection switch before connecting or
disconnecting the shore power cable.
(2) Connect the shore power cable to the
boat first.
(3) If polarity-warning indicator is
activated, immediately disconnect cable.
(4) Disconnect shore power cable at shore
outlet first.
(5) Close shore power inlet cover tightly.
**DO NOT ALTER SHORE
POWER CABLE CONNECTORS**

WARNING
ROTATING PROPELLER(S) MAY CAUSE
SERIOUS INJURY OR DEATH!
DO NOT APPROACH OR USE LADDER
WHEN ENGINE IS RUNNING.

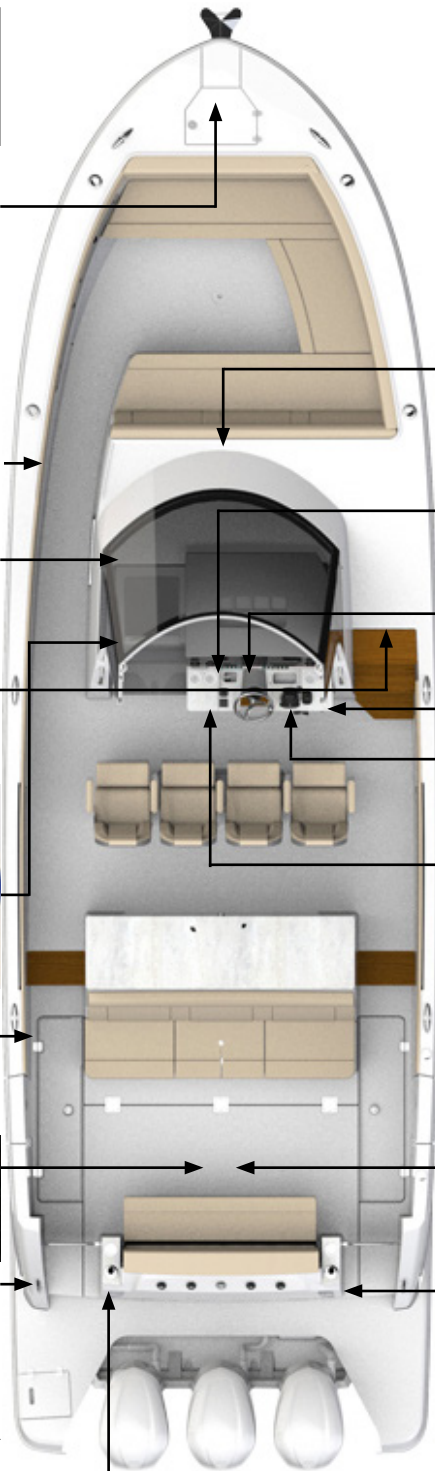

WARNING
ROTATING PROPELLER MAY CAUSE
SERIOUS INJURY OR DEATH.
SHUT OFF ENGINE WHEN
NEAR PERSONS IN THE WATER.
NW-207-08

WARNING
Carbon monoxide (CO) can cause brain damage or death.
Engine and generator exhaust contains odorless and colorless carbon monoxide gas.
Signs of carbon monoxide poisoning include nausea, headache, dizziness, drowsiness,
and lack of consciousness.
Get fresh air if anyone shows signs of carbon monoxide poisoning.
See Owner's Manual for information regarding carbon monoxide poisoning.

WARNING
GASOLINE VAPORS CAN EXPLODE BEFORE STARTING
ENGINE. OPERATE BLOWER 4 MIN. AND CHECK ENGINE
COMPARTMENT FOR GASOLINE LEAKS OR VAPORS. RUN
BLOWER BELOW CRUISING SPEED.

MEETS U.S. EPA EVAP
STANDARDS USING
CERTIFIED COMPONENTS
REGAL MARINE INC., ORLANDO, FL



WARNING
AVOID PERSONAL INJURY!
INTERRUPT SWITCH MUST BE ATTACHED TO OPERATOR*
WHILE ENGINE IS RUNNING. QUALIFIED OPERATOR MUST
BE IN CONTROL AT ALL TIMES.
READ OWNER'S MANUAL BEFORE USE.

WARNING
CARBON MONOXIDE IS A TASTELESS, ODORLESS, AND
INVISIBLE GAS THAT CAN CAUSE DISCOMFORT, SEVERE
AND EVEN DEATH. EXERCISE CAUTION WHILE OPERATING
A GENERATOR OR ENGINE IN CONFINED SPACES OR AT
DOCK SIDE. DO NOT ALLOW HULL EXHAUST OUTLETS TO
BECOME BLOCKED OR EXHAUST FUMES CAN BECOME
TRAPPED IN OR AROUND THE CONFINES OF YOUR VESSEL.

THE DISCHARGE OF ALL FORMS OF PLASTIC INTO ALL WATERS IS PROHIBITED

THE DISCHARGE OF ALL GARBAGE IS PROHIBITED
into the navigable waters of the United States, and into all other waters except as specifically allowed.

ALLOWED: 3 to 12 nautical miles from land – Food waste ground to pass through a one-inch mesh screen.
ALLOWED: 12 or more nautical miles from land – Food waste ground as above, and waste water, and cleaning agents, en route as far from shore as practicable, that are not harmful to the marine environment.

MARPOL ANNEX V – SPECIAL AREAS
GULF OF MEXICO & CARIBBEAN SEA – Food waste en route ground to pass through a one-inch mesh screen.
WESTERN CARIBBEAN REGION – Discharge of all garbage prohibited within 12 nautical miles of land.

Any person who violates the above requirements is liable for civil and/or criminal penalties and regional, state and local restrictions on garbage discharges may also apply.

REPORT ILLEGAL DISPOSAL TO THE U.S. COAST GUARD ON VHF RADIO CHANNEL 16

DANGER
Carbon monoxide (CO) can cause brain damage
or death.
Engine and generator exhaust contains odorless
and colorless carbon monoxide gas.
Carbon monoxide will be around the back of the
boat when engines or generators are running.
Move to fresh air, if you feel nausea, headache,
dizziness, or drowsiness.

YAMAHA OPTIMUS STEERING SYSTEM (TWIN O/B SHOWN)

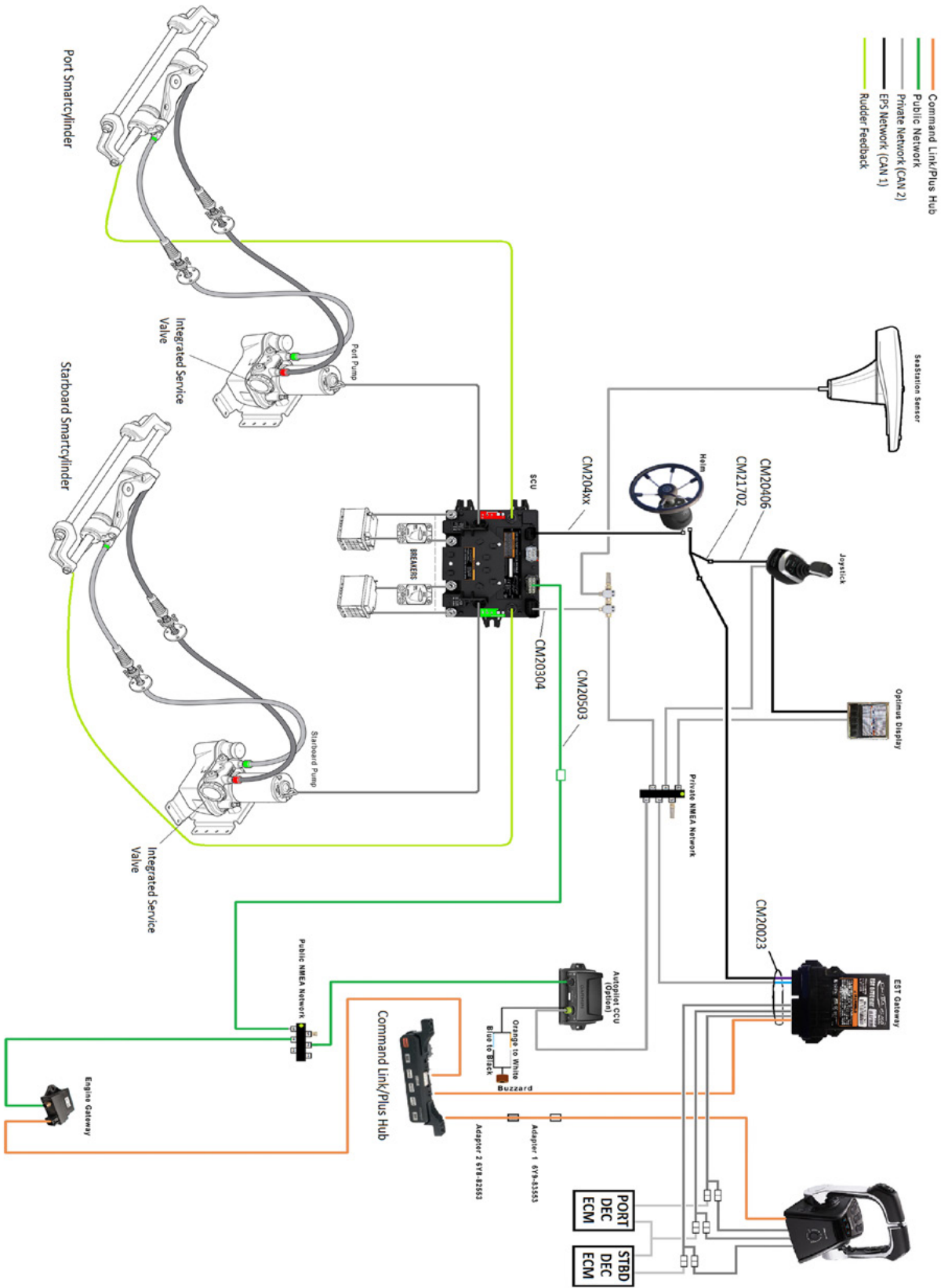

YAMAHA OPTIMUS FUEL HARNESS

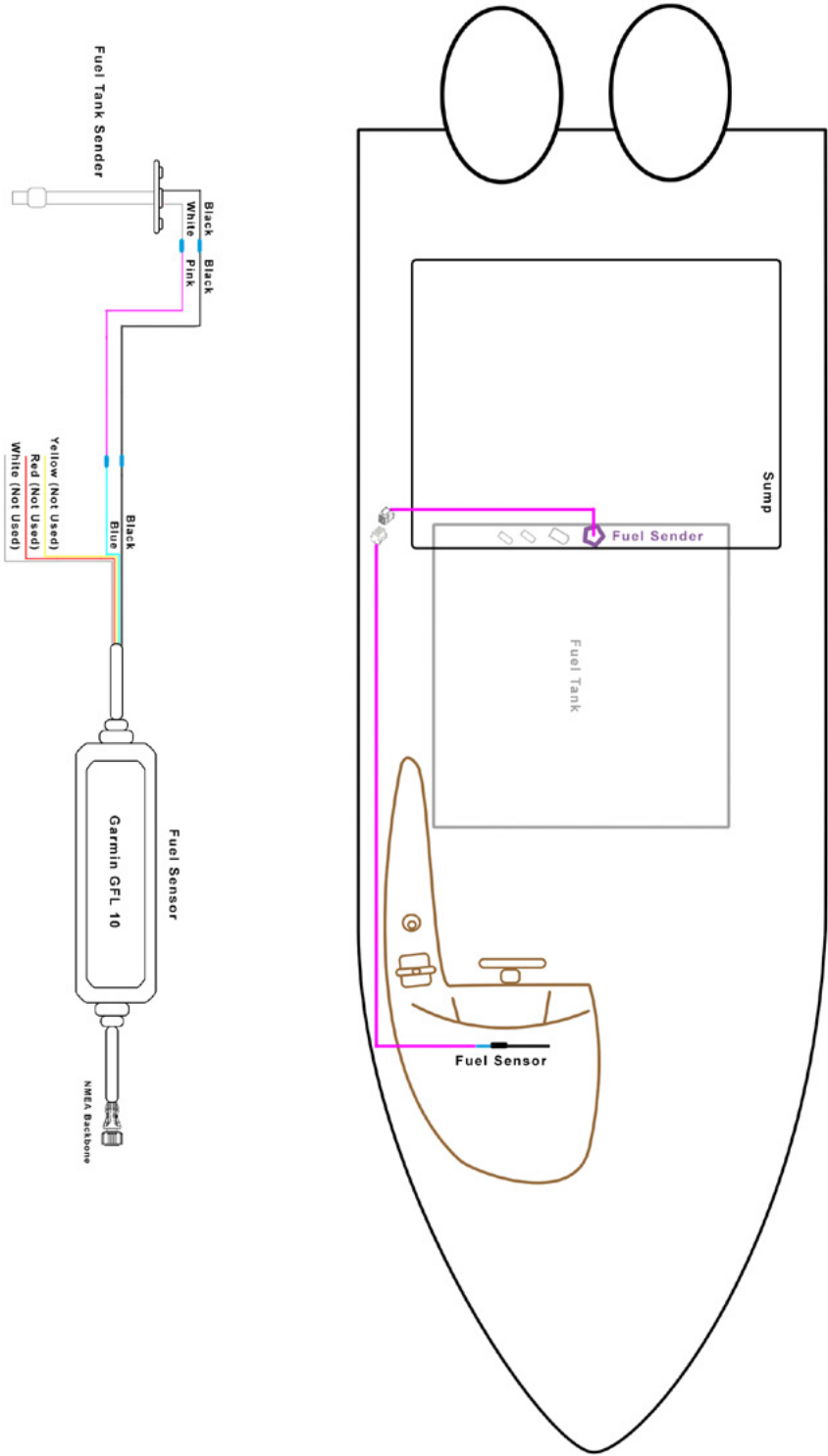

GARMIN ETHERNET NETWORK



NOTE GARMIN ETHERNET NETWORK LOCATED BEHIND GARMIN STBD. PLOTTER

YAMAHA OPTIMUS NMEA NETWORK

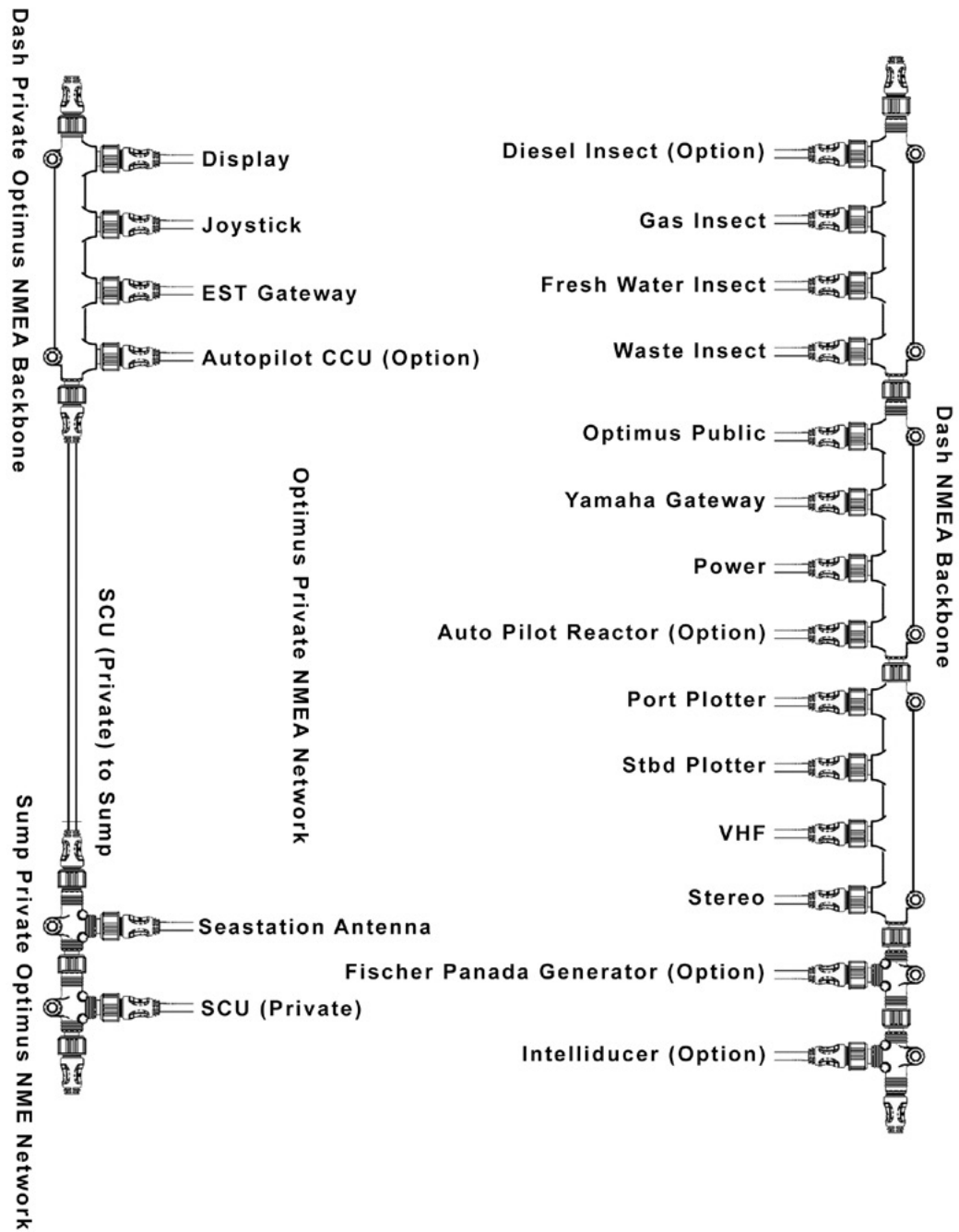

AMPLIFIER SPEAKER WIRING

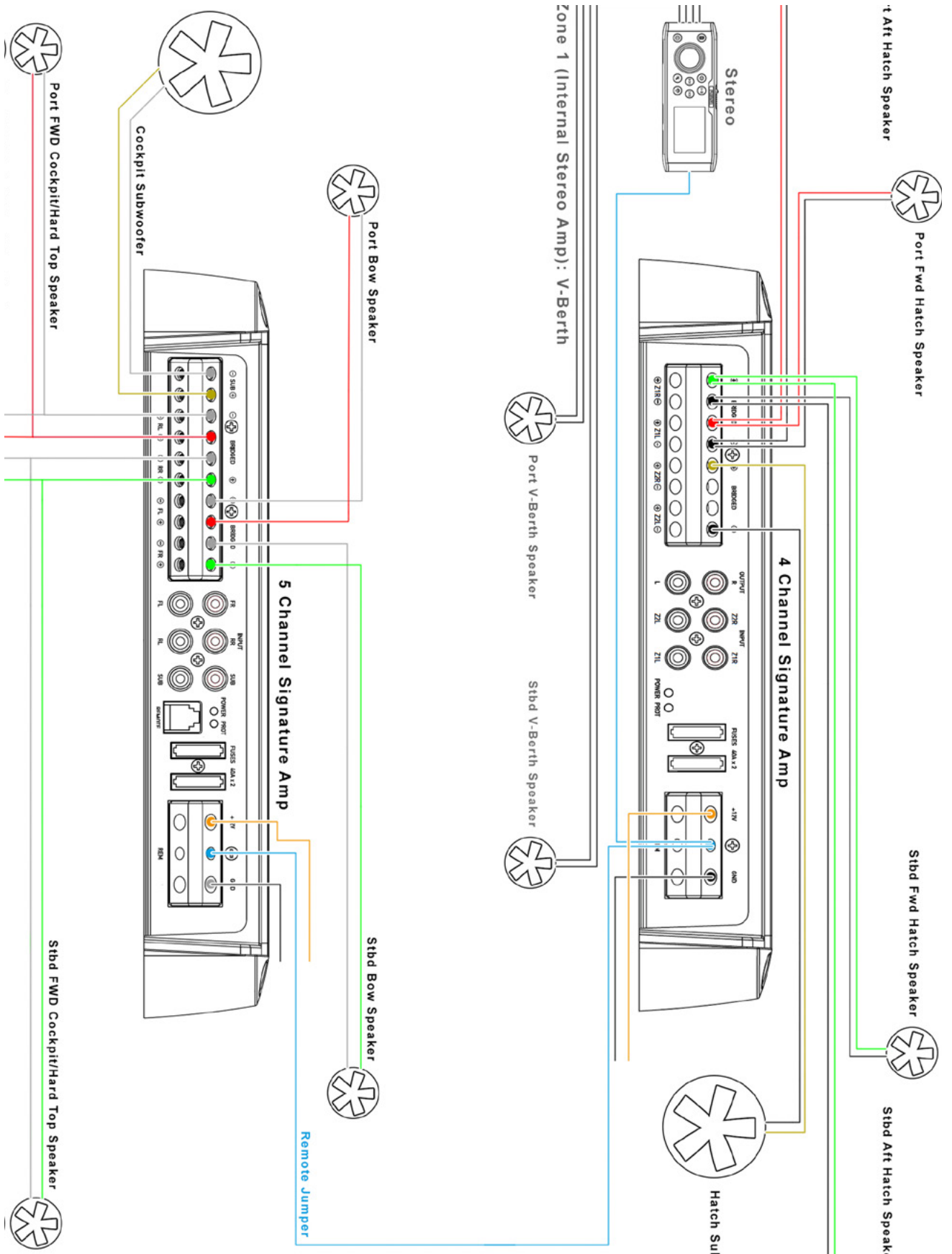

HULL HARDWARE AFT THRU-HULLS

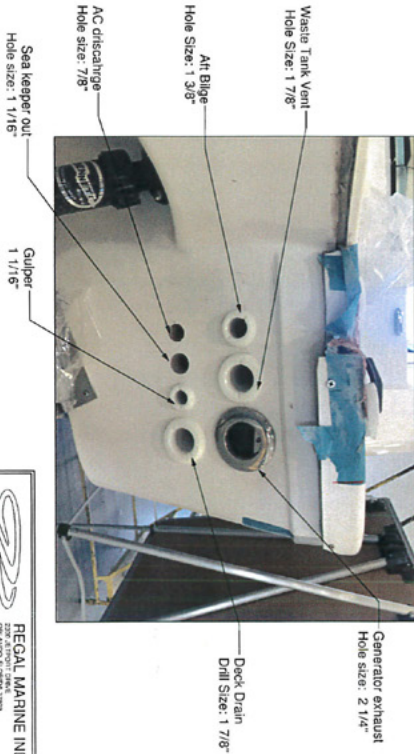
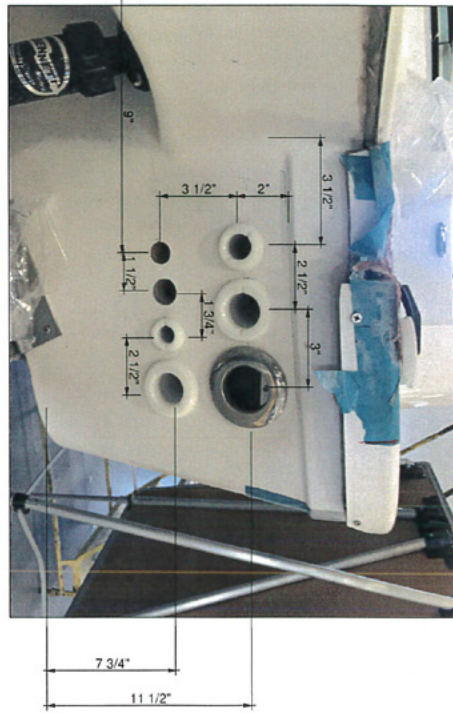
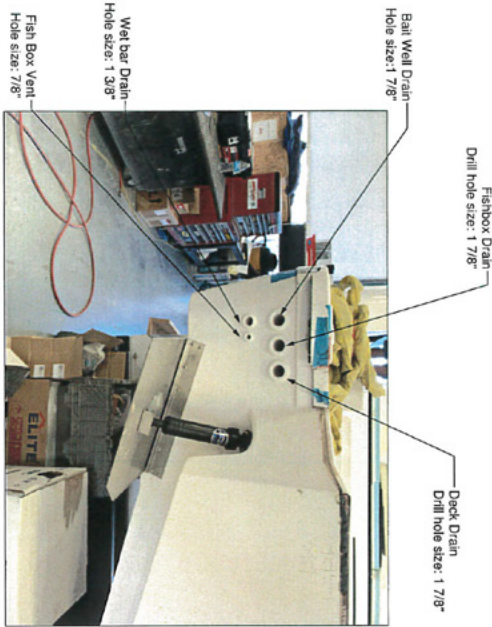
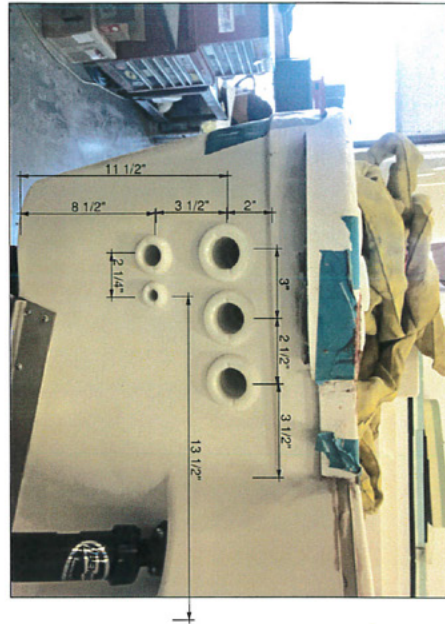

REPLICATING AND/OR CONTINUING THE MANUFACTURE OF THIS DRAWING IS THE SOLE PROPERTY OF REGAL MARINE INDUSTRIES. ANY REPRODUCTION OF THIS DRAWING WITHOUT THE WRITTEN PERMISSION OF REGAL MARINE INDUSTRIES IS PROHIBITED.

 REGAL MARINE INDUSTRIES 10000 W. 10th Street, Suite 200 Fort Lauderdale, FL 33309		ALL RIGHTS RESERVED	
DRAWING TITLE 38 SAV (SV) Hull Hardware			
DATE	7/1/2019	REVISION	2 OF 3
DRAWN BY	AWR	APPROVED BY	MSV24B

DECK HARDWARE 1 AFT

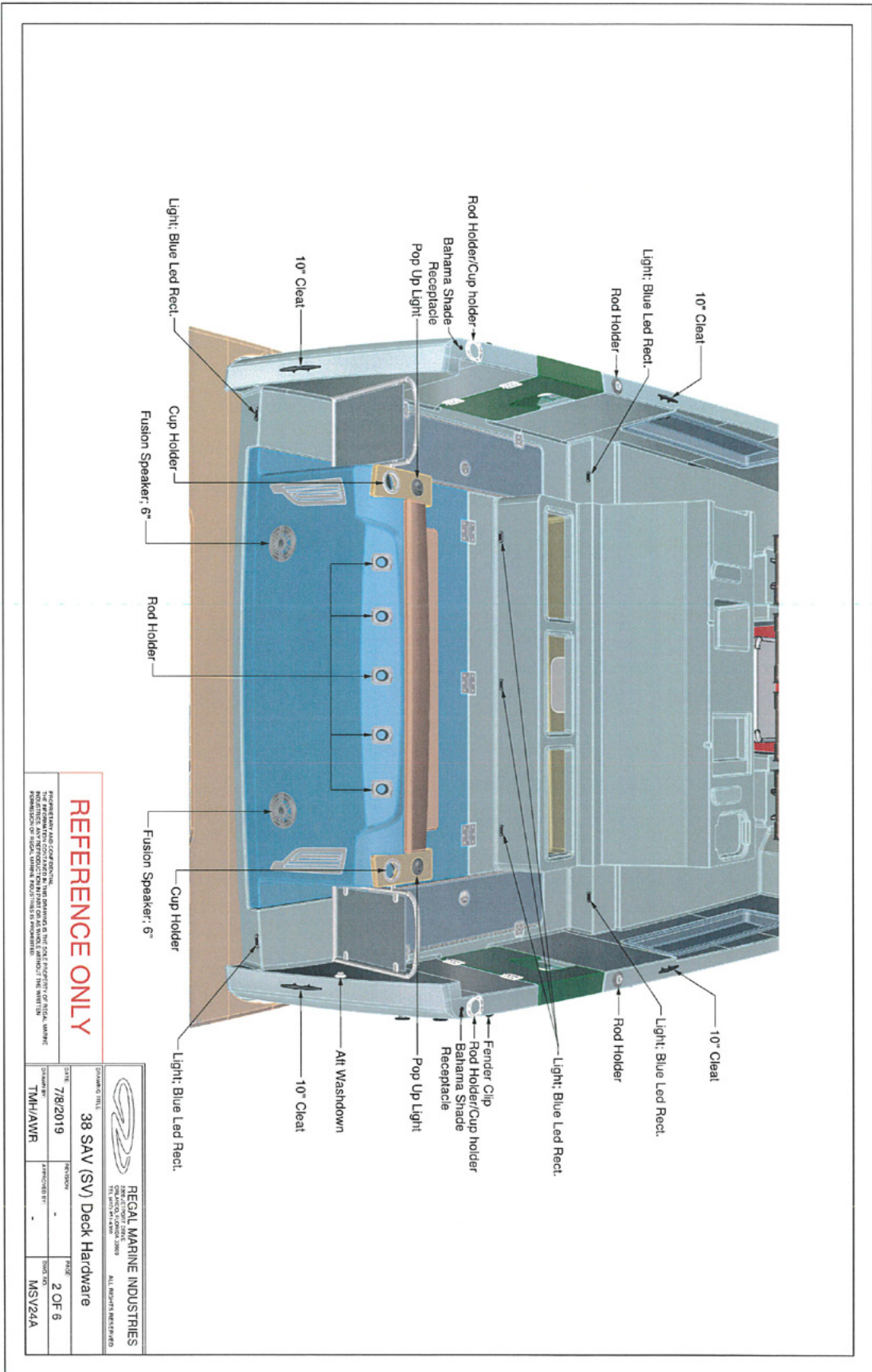

REFERENCE ONLY

REGAL MARINE AND CO. BOAT BUILDING, INC. HAS PROVIDED THE PARTS LIST FOR THE 38 SAV (SV) BOAT. THIS LIST IS FOR REFERENCE ONLY. THE PARTS LIST IS NOT A CONTRACT. THE PARTS LIST IS SUBJECT TO CHANGE WITHOUT NOTICE. THE PARTS LIST IS NOT A WARRANTY. THE PARTS LIST IS NOT A GUARANTEE. THE PARTS LIST IS NOT A CONTRACT. THE PARTS LIST IS NOT A WARRANTY. THE PARTS LIST IS NOT A GUARANTEE.

 REGAL MARINE INDUSTRIES 10000 W. COUNTY ROAD 200 FORT WORTH, TEXAS 76150 TEL: 817.486.3333 FAX: 817.486.3334 WWW.REGALMARINE.COM			
DRAWING TITLE: 38 SAV (SV) Deck Hardware			
DATE:	7/8/2019	REVISION:	2 OF 6
DRAWN BY:	TMH/AWR	APPROVED BY:	MSV24A

DECK HARDWARE 2 BOW

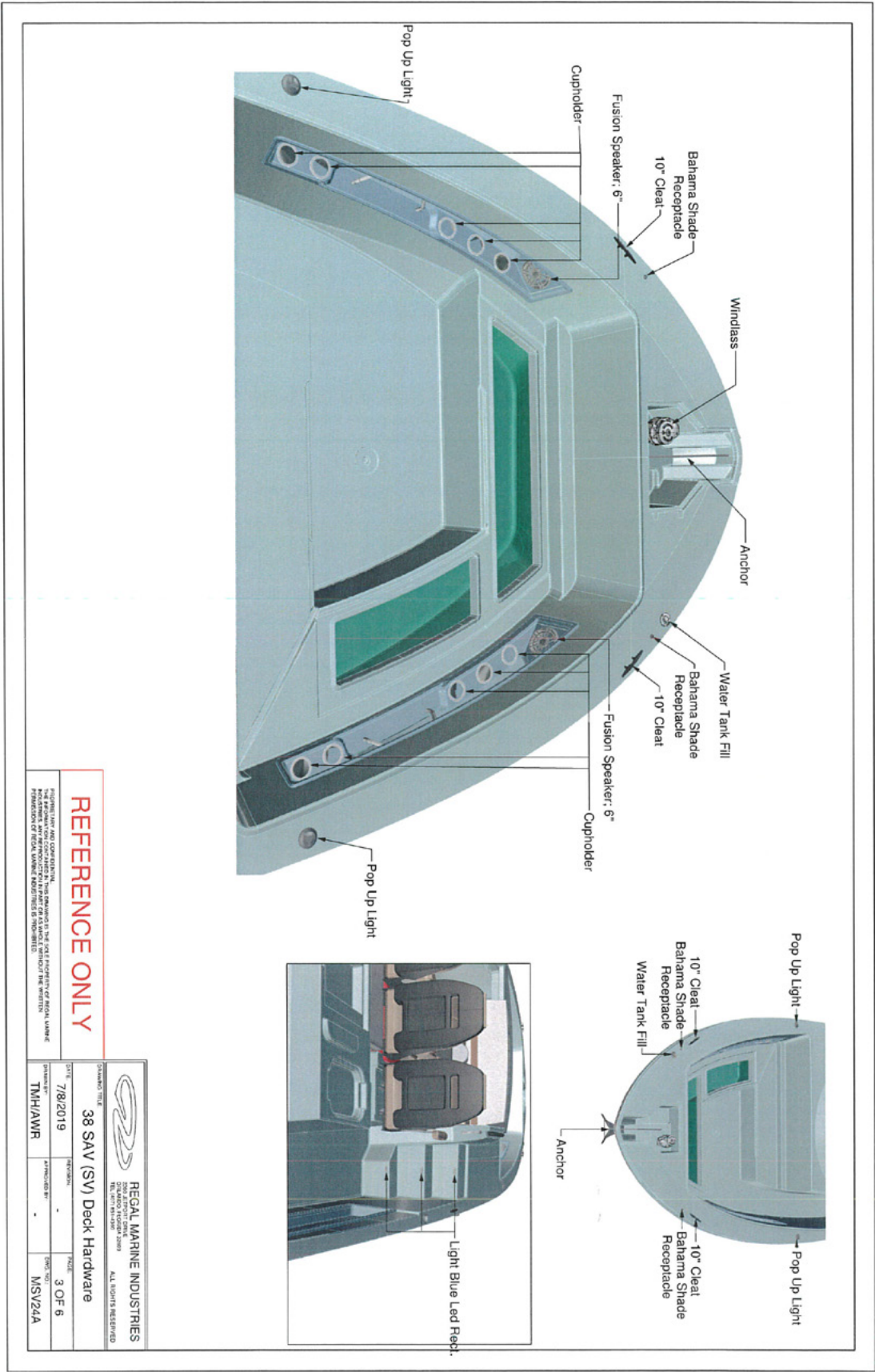

REFERENCE ONLY

REGAL MARINE INDUSTRIES, INC. AND COMPANIES IN THIS AREA ARE THE SOLE PROPERTY OF REGAL MARINE INDUSTRIES, INC. ALL RIGHTS RESERVED.

 REGAL MARINE INDUSTRIES <small>3000 BAYVIEW DRIVE FORT MYERS BEACH, FL 33908</small>	
DRAWING TITLE 38 SAV (SV) Deck Hardware	ALL RIGHTS RESERVED
DATE 7/8/2019	REVISION -
DRAWN BY TMH/AWR	CHECKED BY -
SCALE MSV24A	PAGES 3 OF 6

DECK HARDWARE 4 PORT

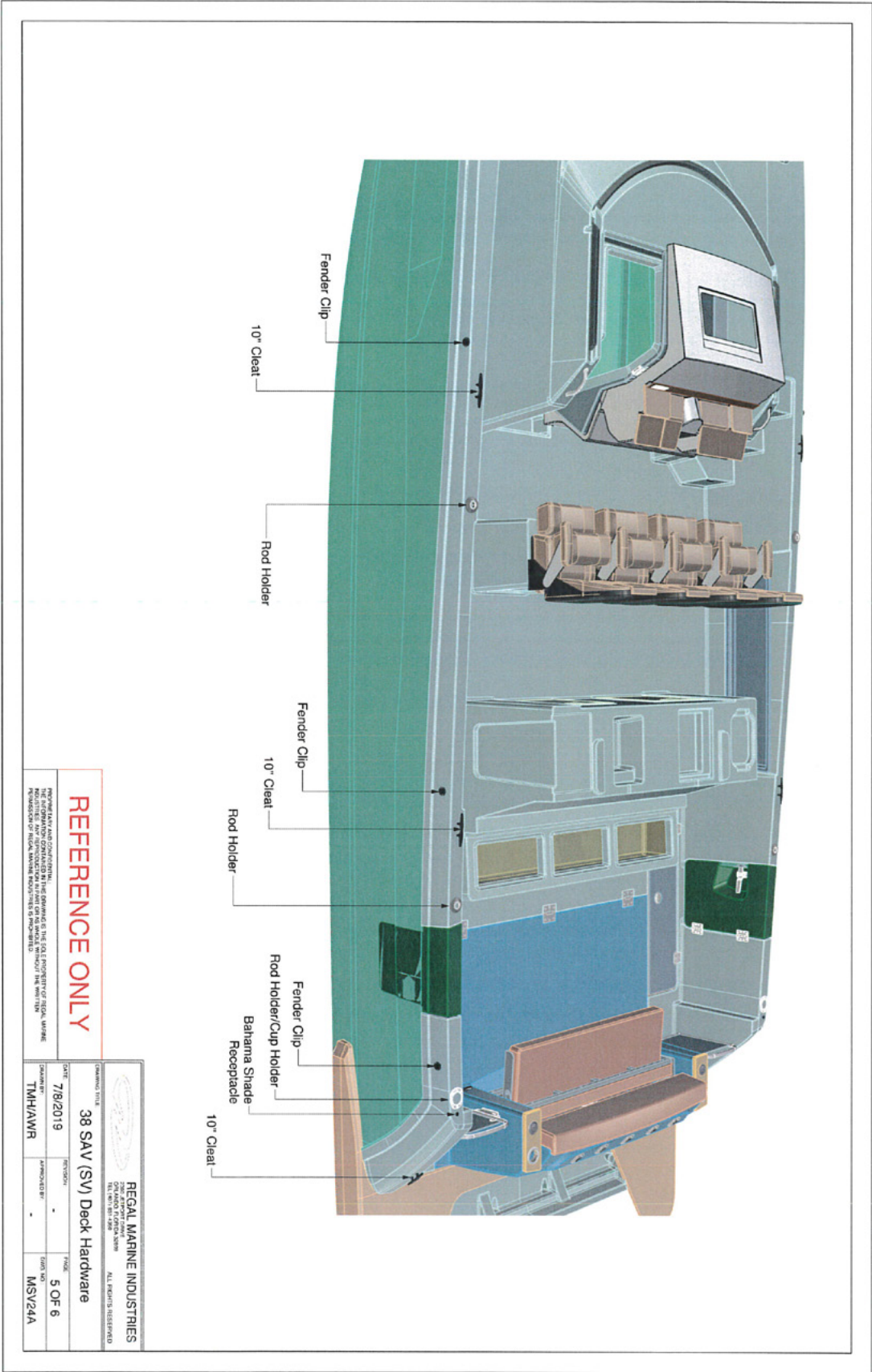

REFERENCE ONLY

REGAL MARINE INDUSTRIES
 2000 W. STATE ST. #100
 TAMPA, FL 33606
 TEL: (813) 942-1000
 FAX: (813) 942-1001
 WWW.REGALMARINE.COM

 REGAL MARINE INDUSTRIES <small>2000 W. STATE ST. #100 TAMPA, FL 33606 TEL: (813) 942-1000 FAX: (813) 942-1001 WWW.REGALMARINE.COM ALL RIGHTS RESERVED</small>	
DRAWING TITLE	
38 SAV (SV) Deck Hardware	
DATE	7/8/2019
DRAWN BY	TMH/AWR
REVISION	-
APPROVED BY	-
ISSUE NO.	5 OF 6
DATE	MSV24A

DECK HARDWARE 5 TRANSOM

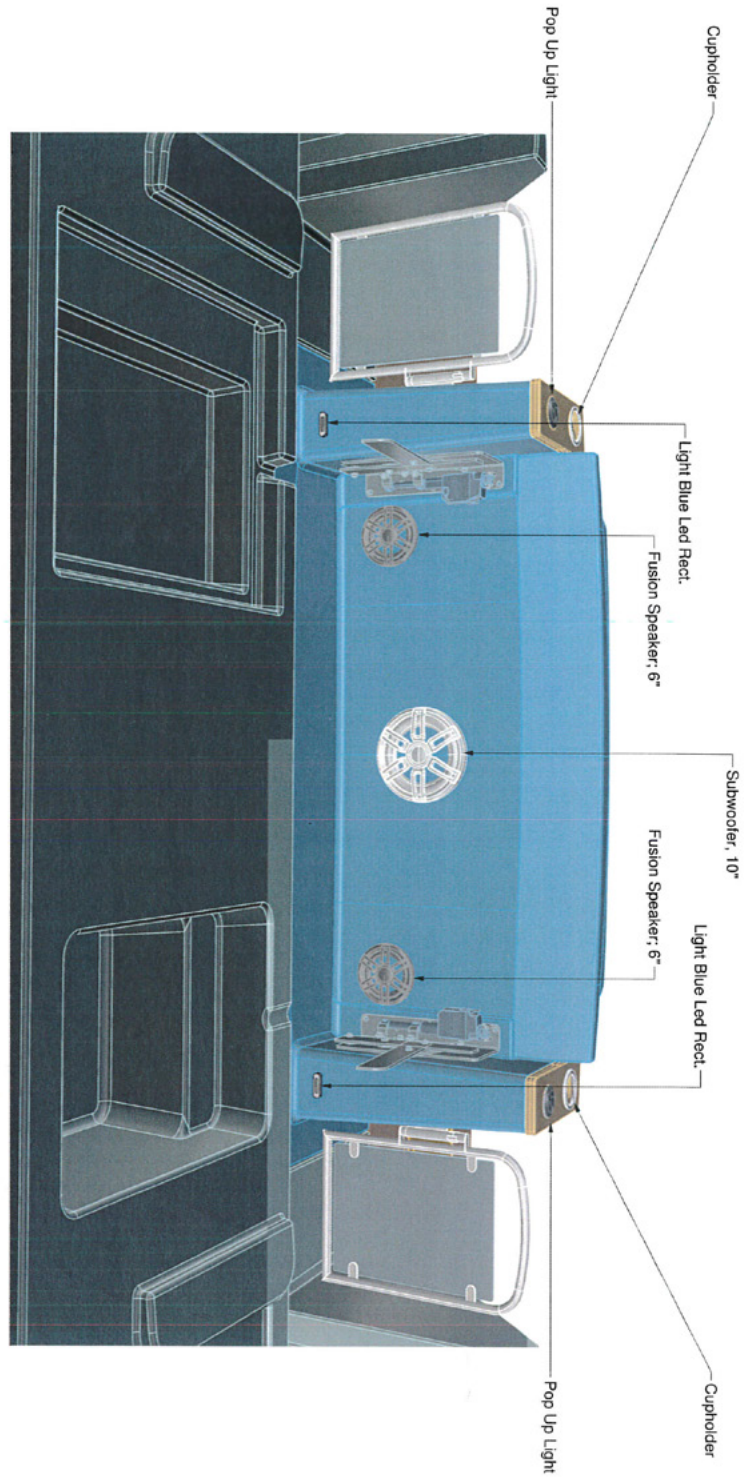

REFERENCE ONLY

REGAL MARINE INDUSTRIES, INC. MAKES NO WARRANTY, REPRESENTATION OR GUARANTEE OF ANY KIND, EXPRESS OR IMPLIED, REGARDING THE ACCURACY OF THE INFORMATION CONTAINED HEREIN. THE INFORMATION IS PROVIDED FOR REFERENCE ONLY AND SHOULD NOT BE USED AS A BASIS FOR ANY DECISION.

 REGAL MARINE INDUSTRIES <small>10000 W. TOWN CENTER DRIVE, SUITE 100, TAMPA, FL 33613</small> <small>TEL: 813.861.4400</small>		ALL RIGHTS RESERVED	
ORDER NO.	38 SAV (SV) Deck Hardware	REV.	6 OF 6
DATE	7/8/2019	APPROVED BY	
DESIGNED BY	TMH/AWR	DATE	MSV24A

AMPLIFIER RCA WIRING/SETTINGS

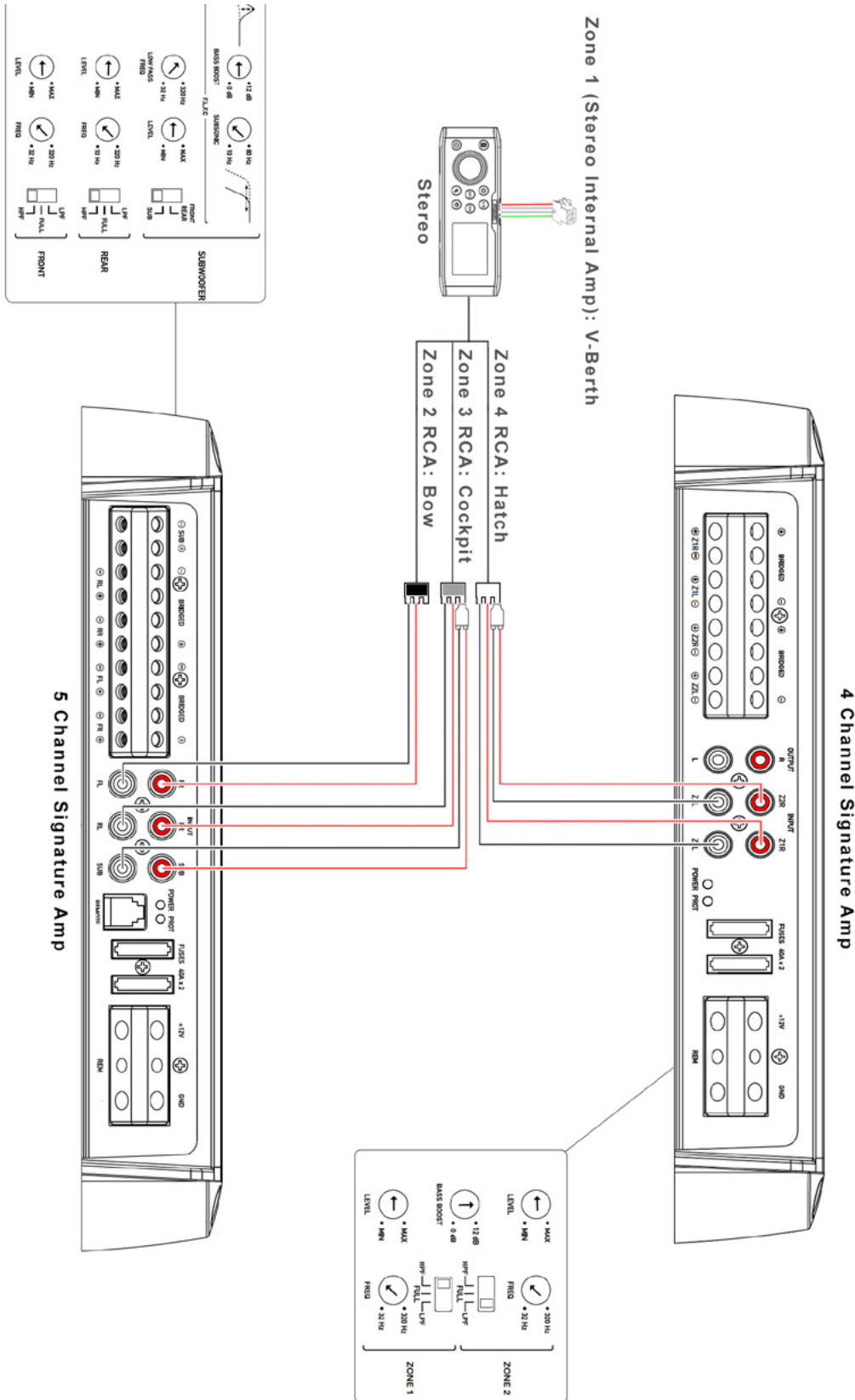

BATTERY MANAGEMENT SYSTEM OVERVIEW

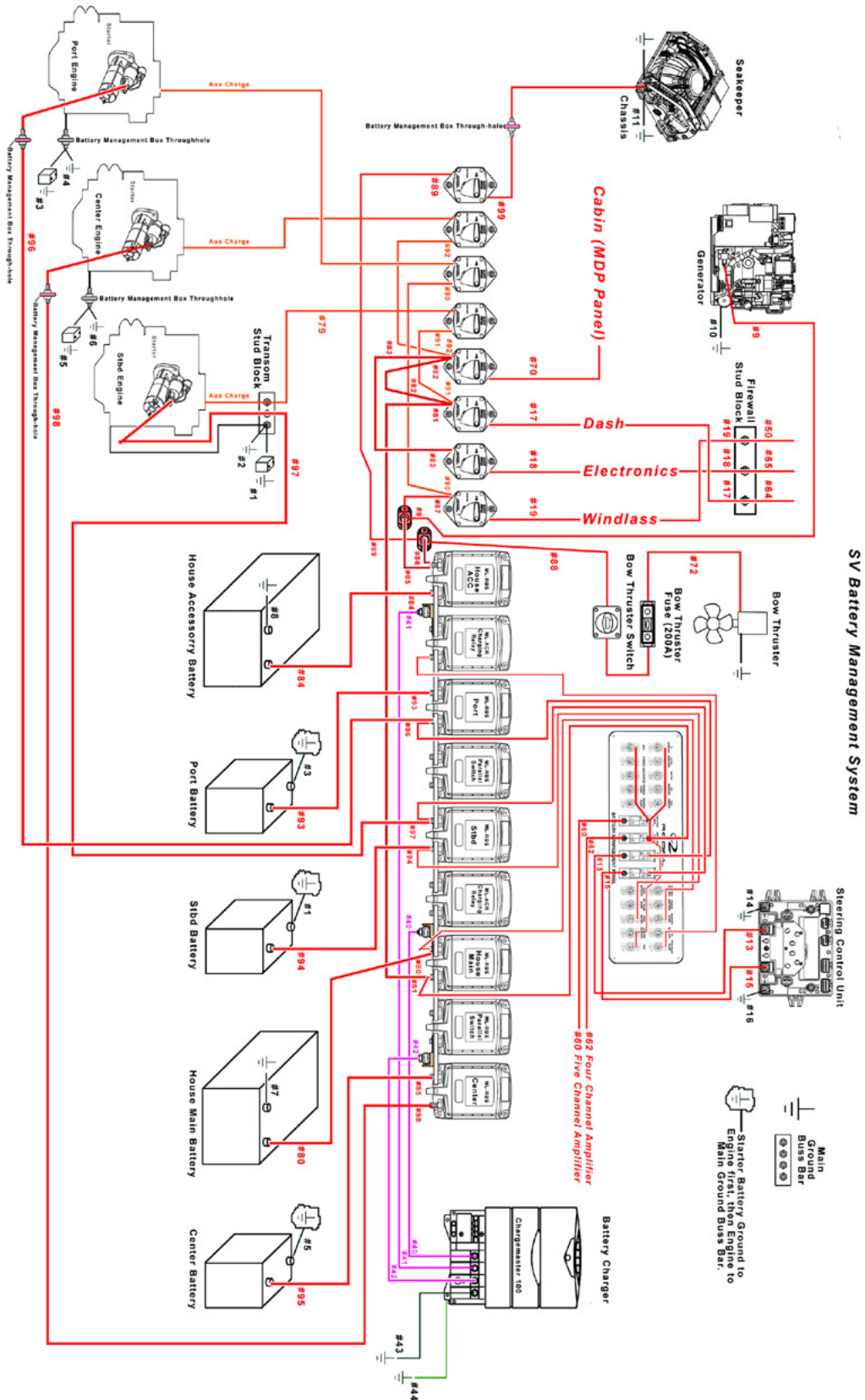

BATTERY MANAGEMENT PANEL COMPONENTS

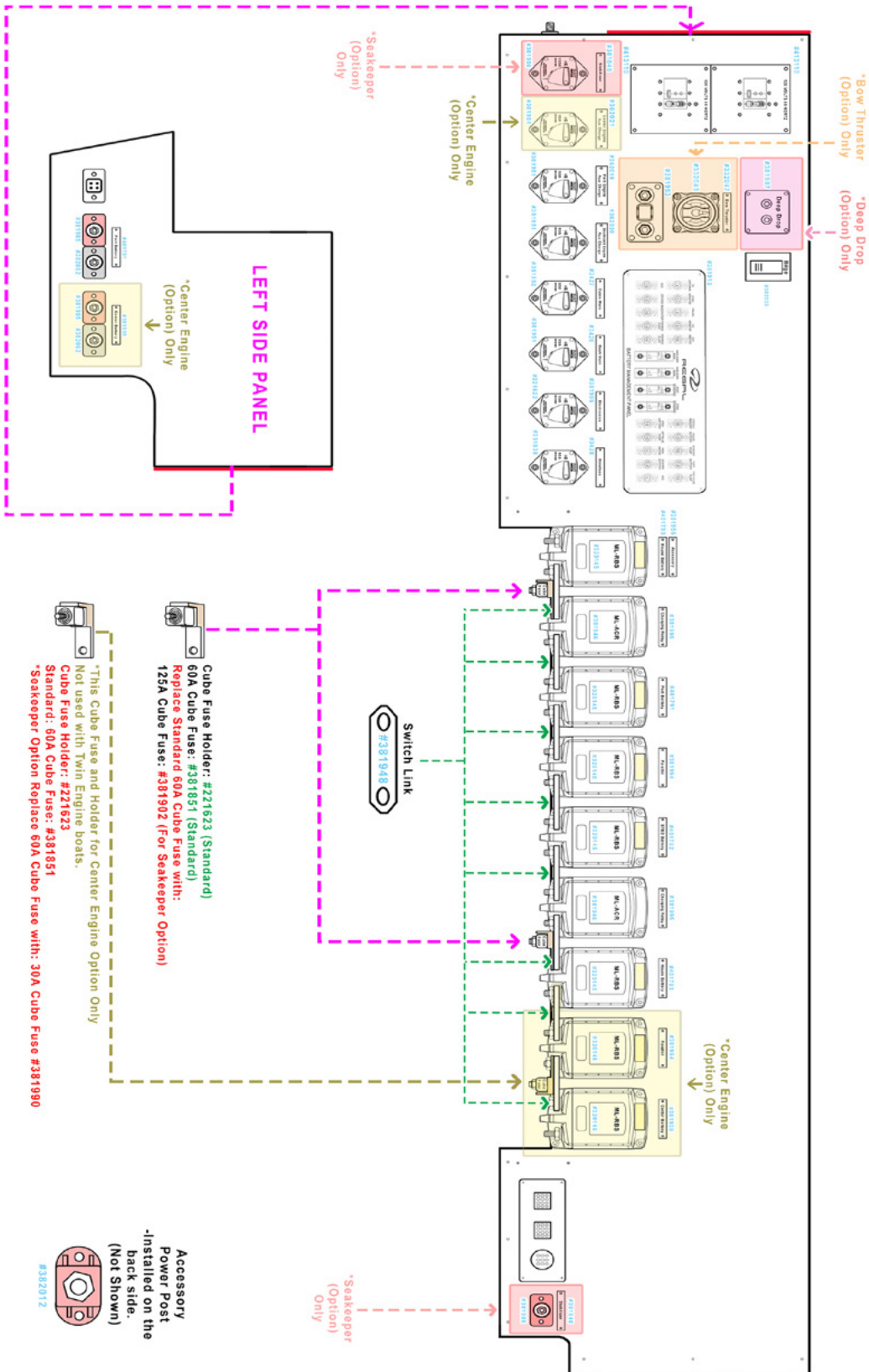

38 SV Battery Management Assembly
Page 1: Components

BATTERY MANAGEMENT PANEL SWITCHES/HARNESSES

38 SV Battery Management Assembly Page 2: Battery Switches/Harness

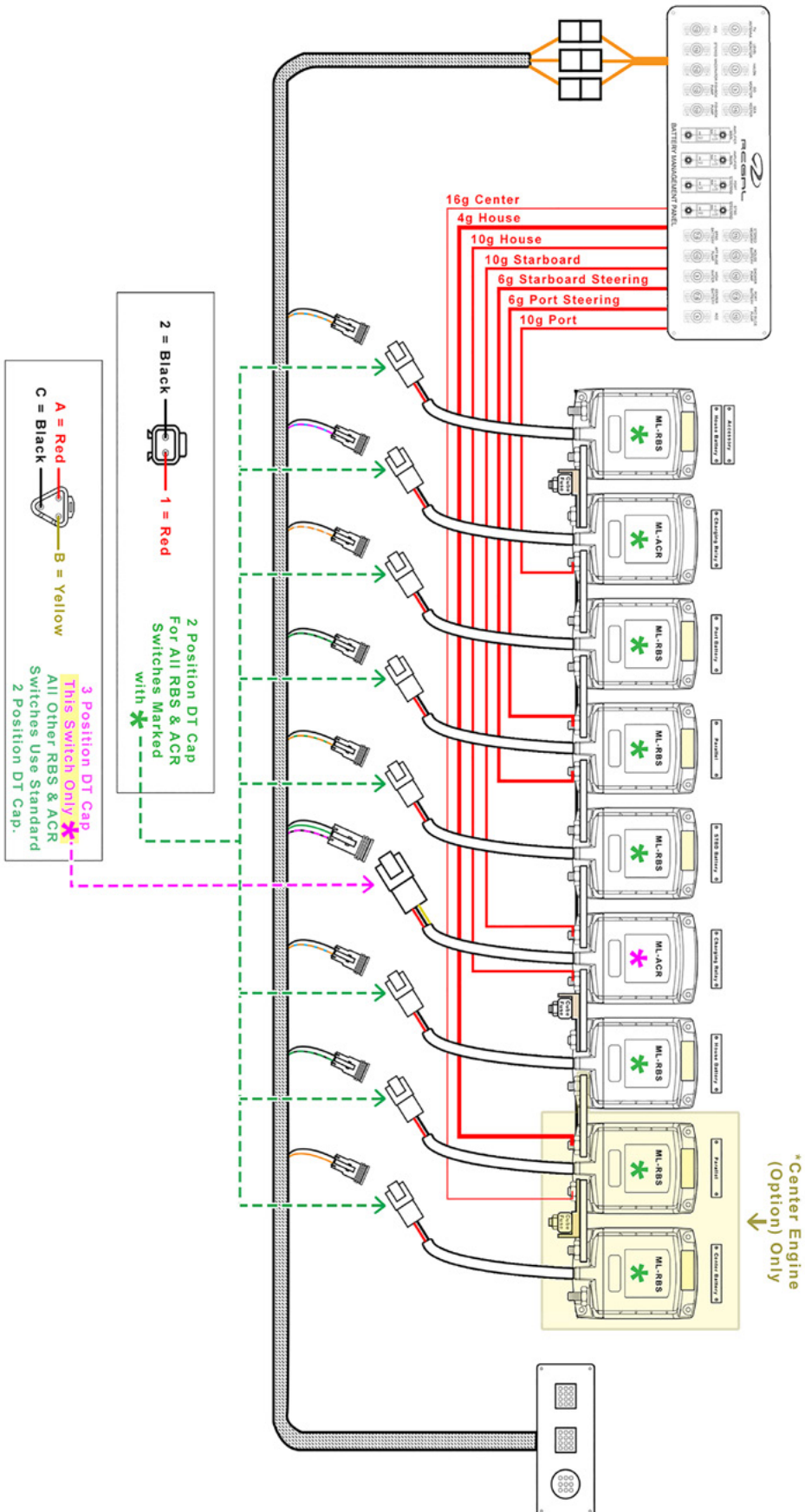

BATTERY MANAGEMENT PANEL- POWER CABLE OVERVIEW

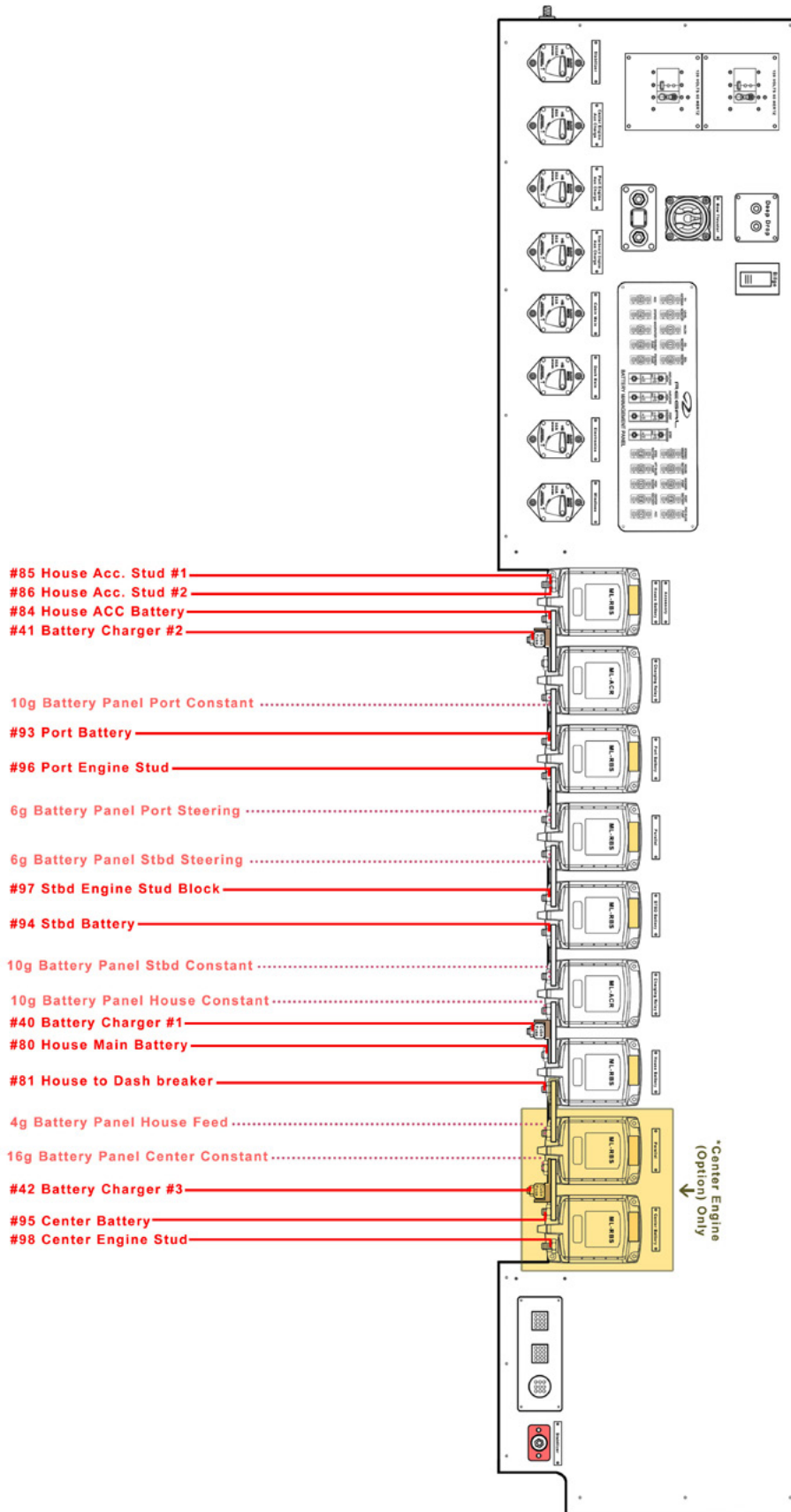

38 SV Battery Management Assembly
Page 3: Switch Power Cables

BATTERY MANAGEMENT PANEL POWER CABLES 1

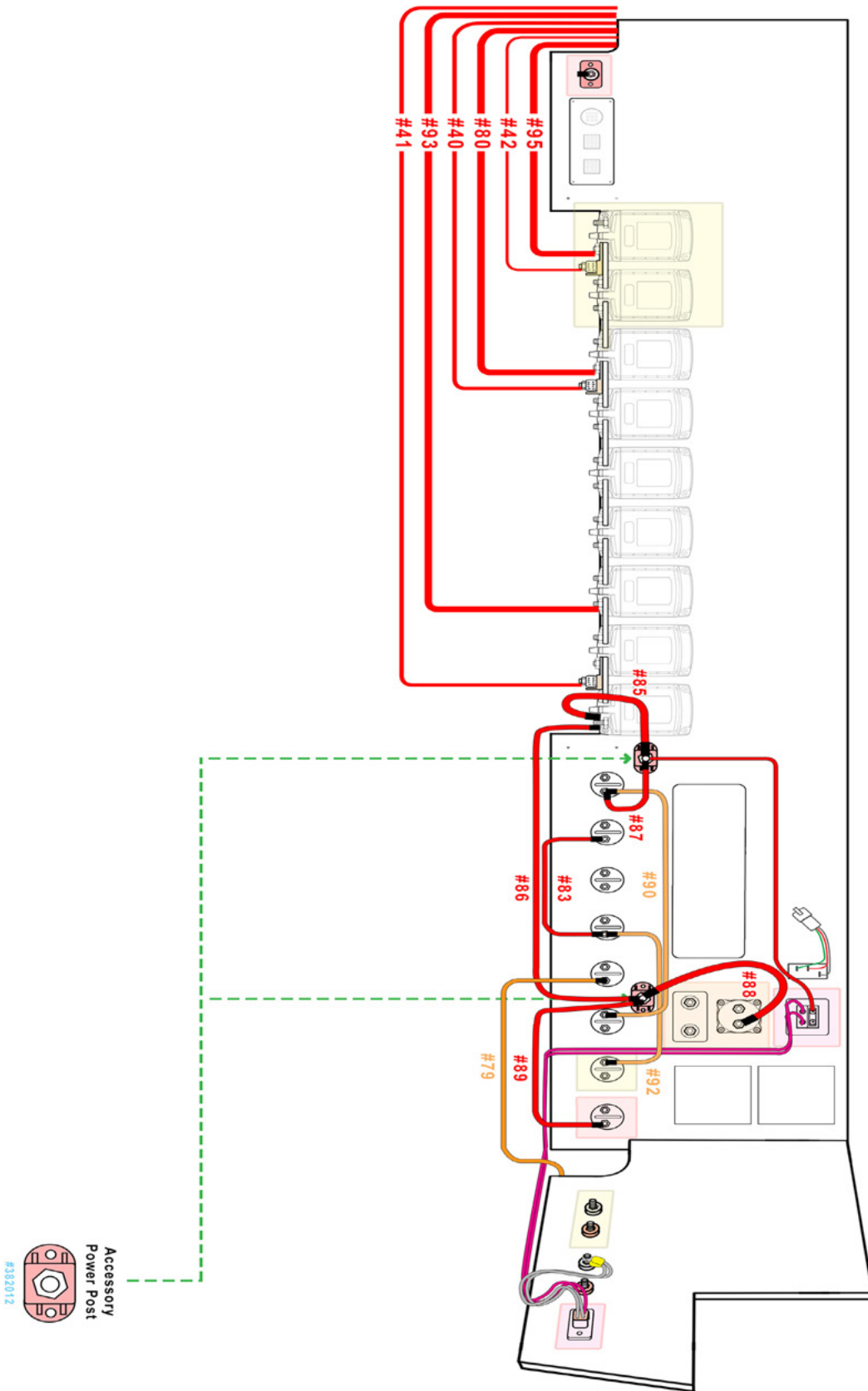

BATTERY MANAGEMENT PANEL POWER CABLES 2

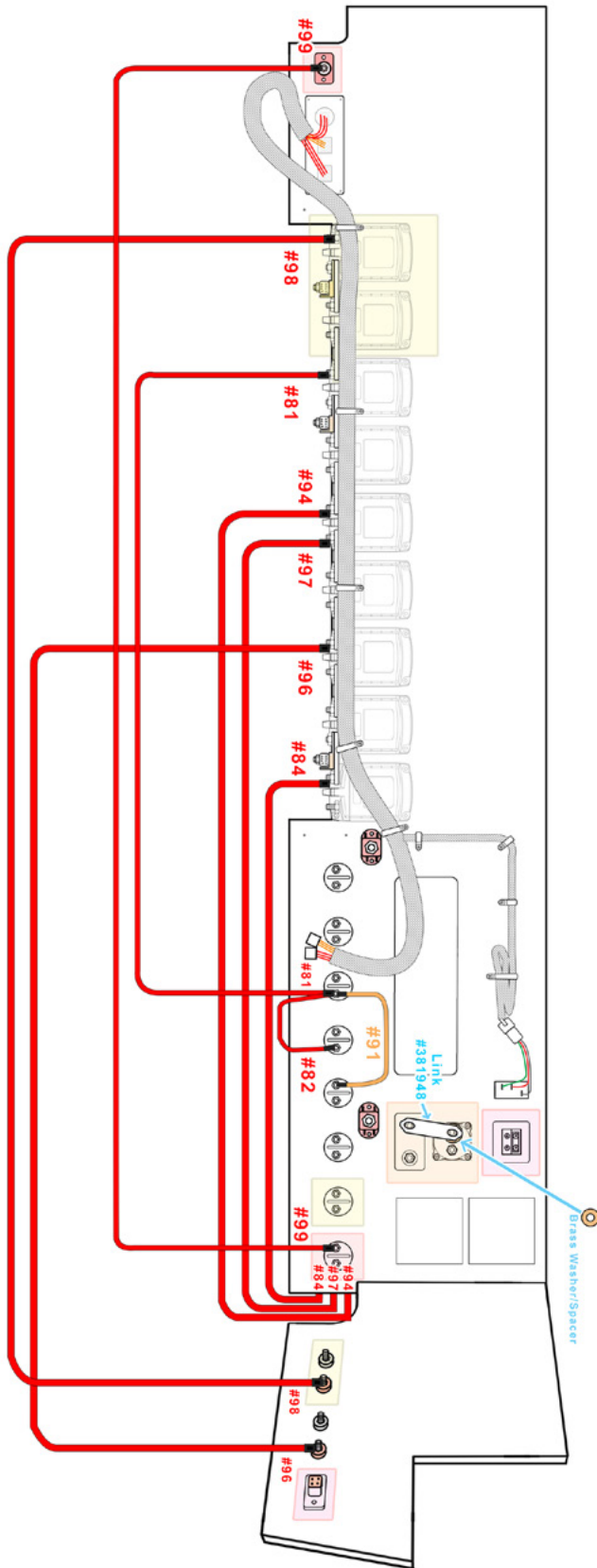

38 SV Battery Management Assembly
Page 5: Power Cables 2

BATTERY MANAGEMENT PANEL POWER CABLES 3

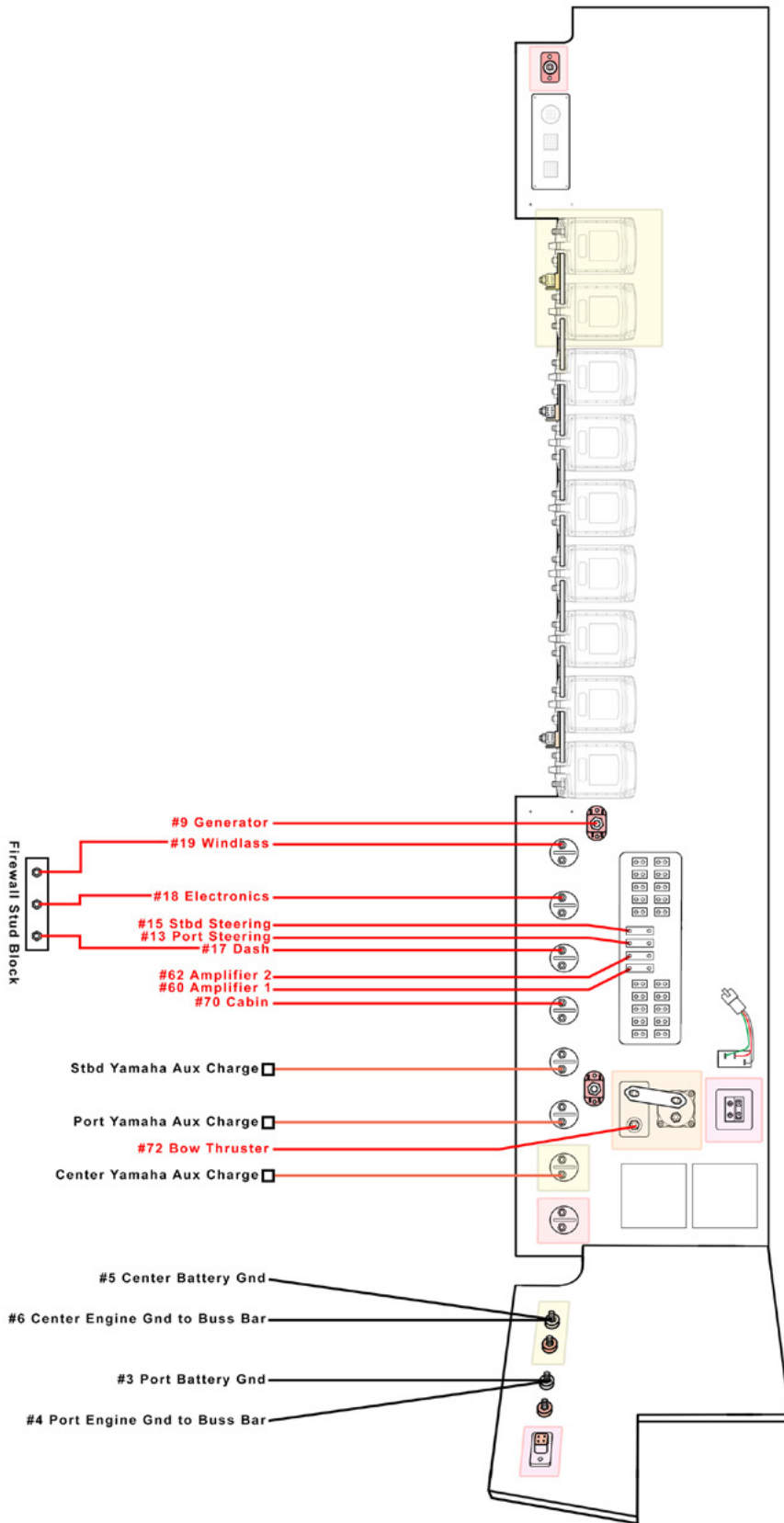

38 SV Battery Management Assembly
Page 6: Power Cables 3

DECK HARNESS ROUTING 1

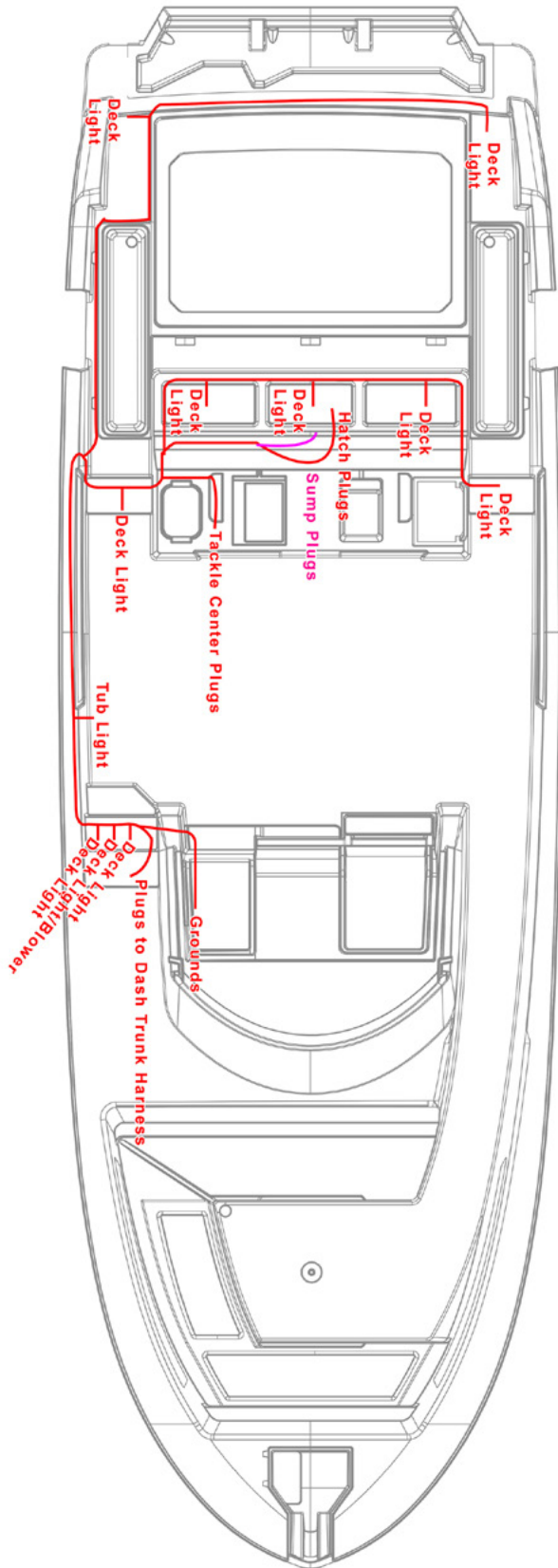

SV Deck Harness Routings
Aft Deck

DECK HARNESS ROUTING 2

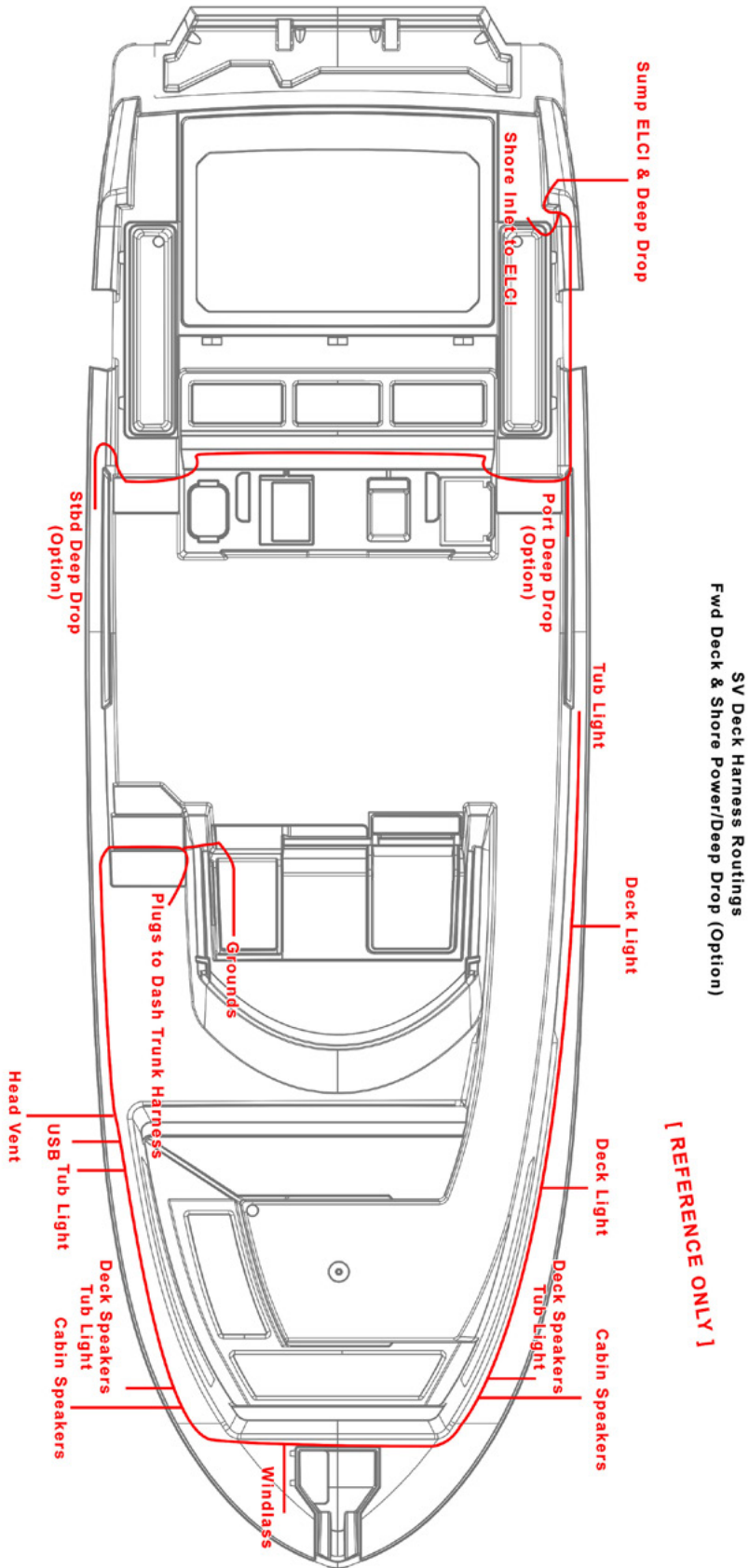

SV Deck Harness Routings
Fwd Deck & Shore Power/Deep Drop (Option)

DECK HARNESS ROUTING 3

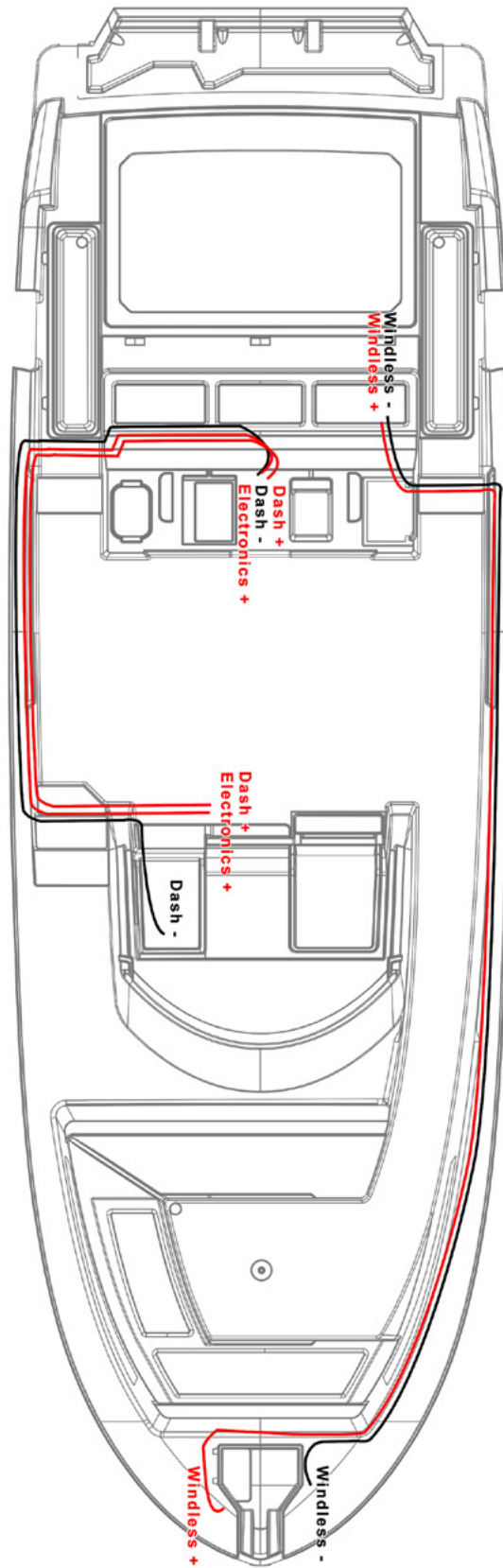

SV Deck Harness Routings
Dash and Windlass Power

DECK HARNESS ROUTING 4

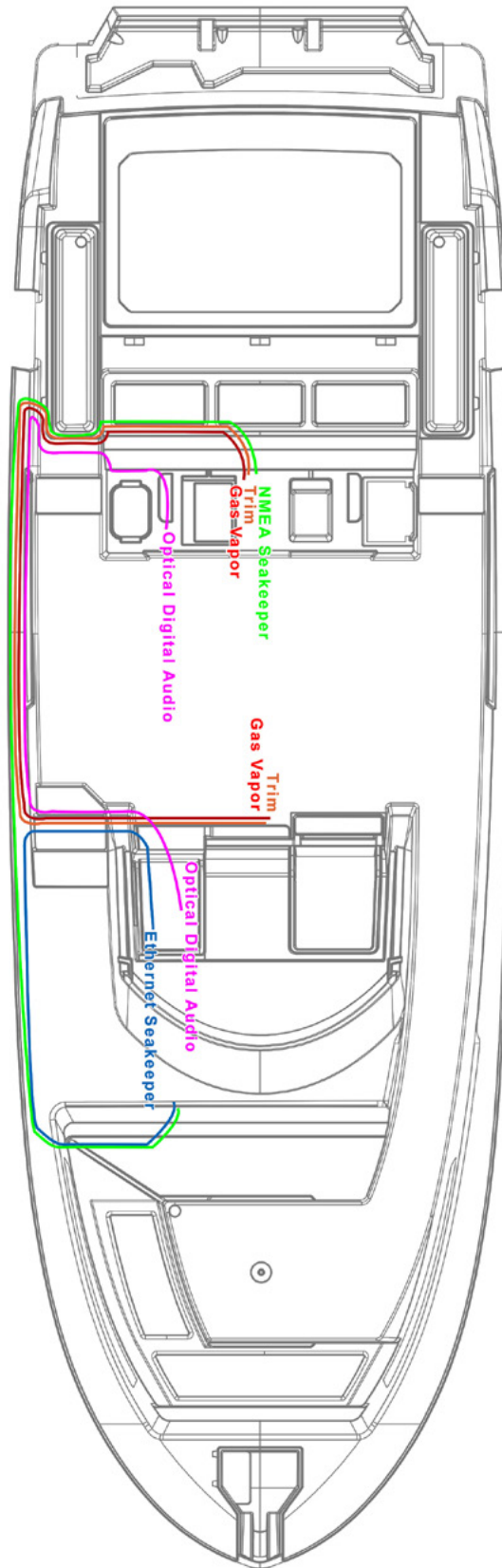

SV Deck Harness Routings
Trim, Gas Vapor, Seakeeper and Optical

DECK HARNESS ROUTING 5

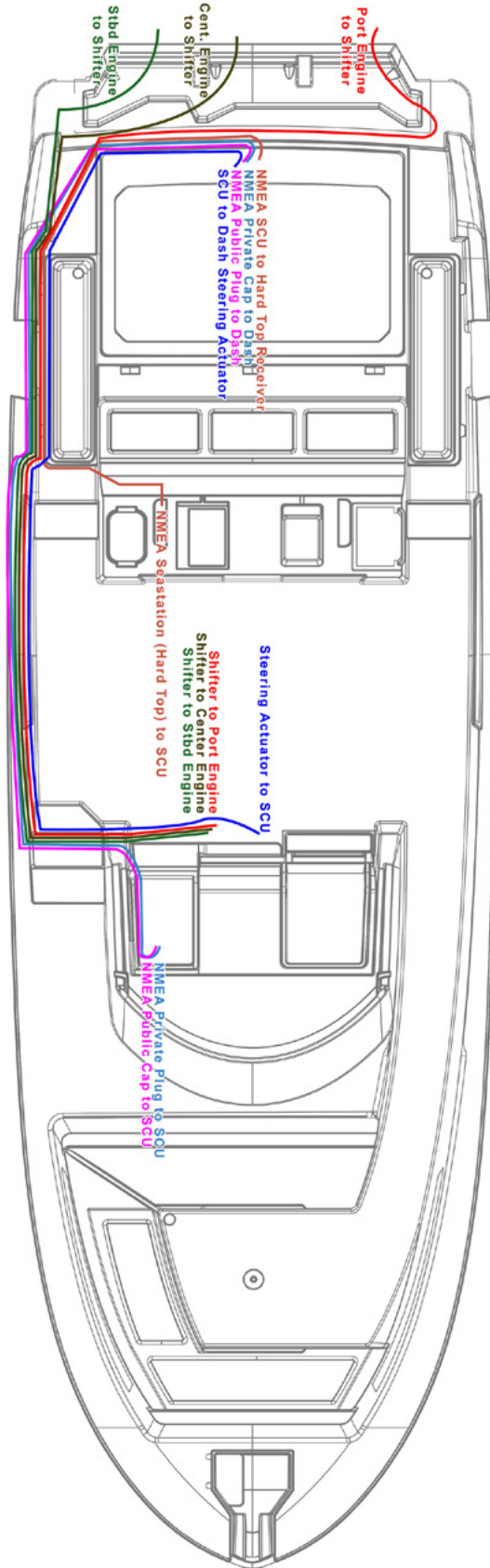

SV Deck Harness Routings
Optimus

D.C. DISTRIBUTION PANEL/REAR

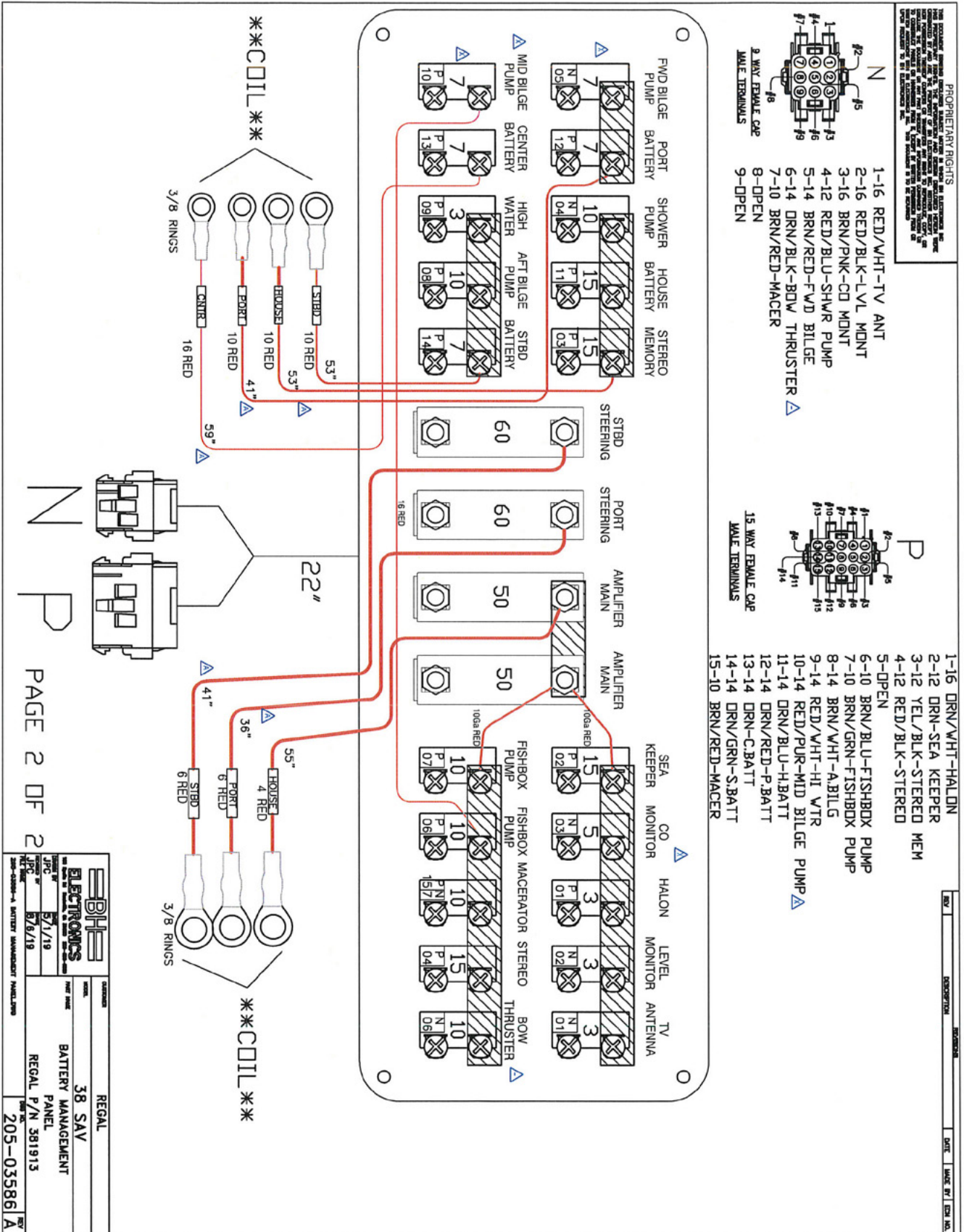

HELM D.C. BREAKER PANEL/FRONT

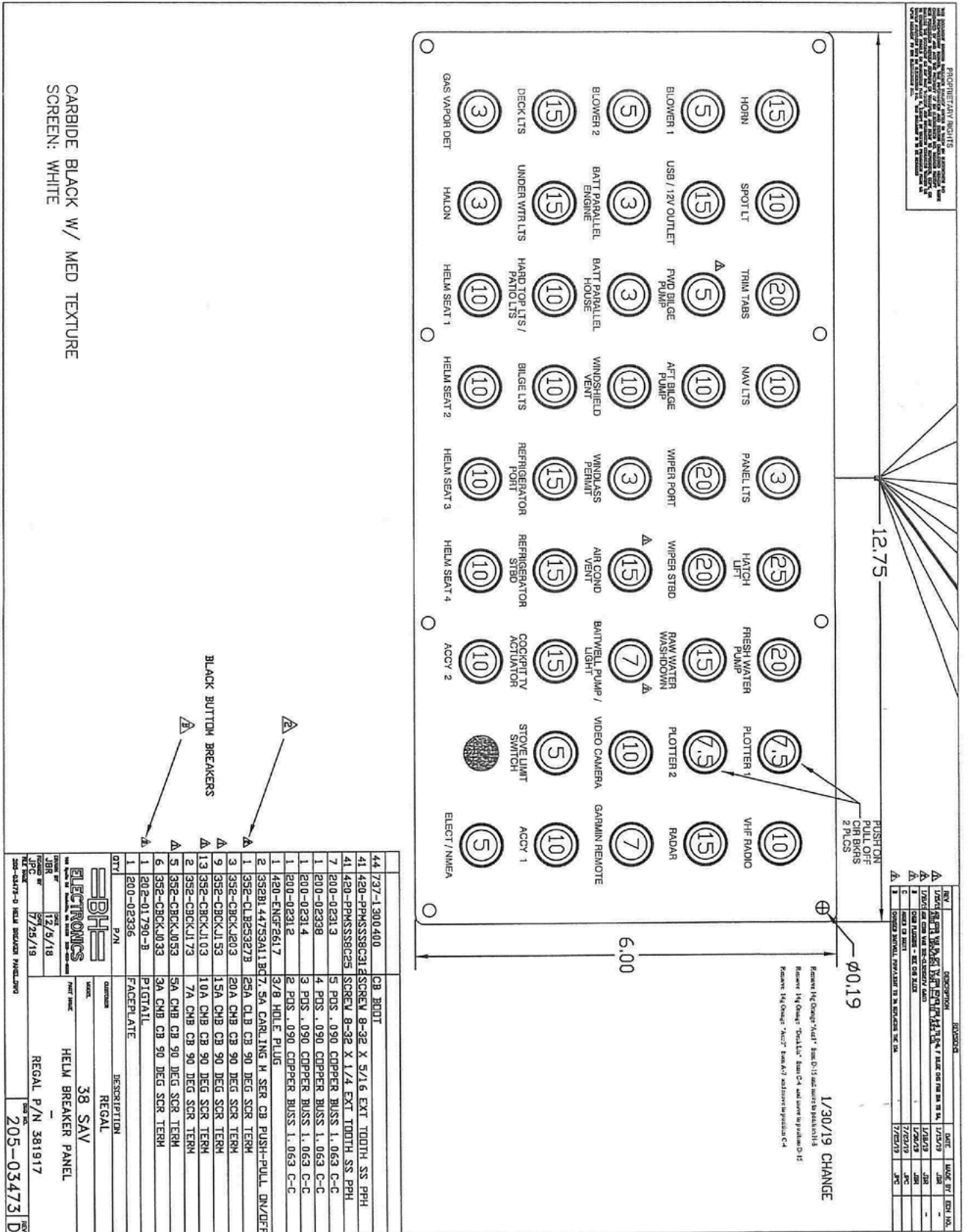

120 VOLT AC SHIP'S MAIN PANEL/FRONT

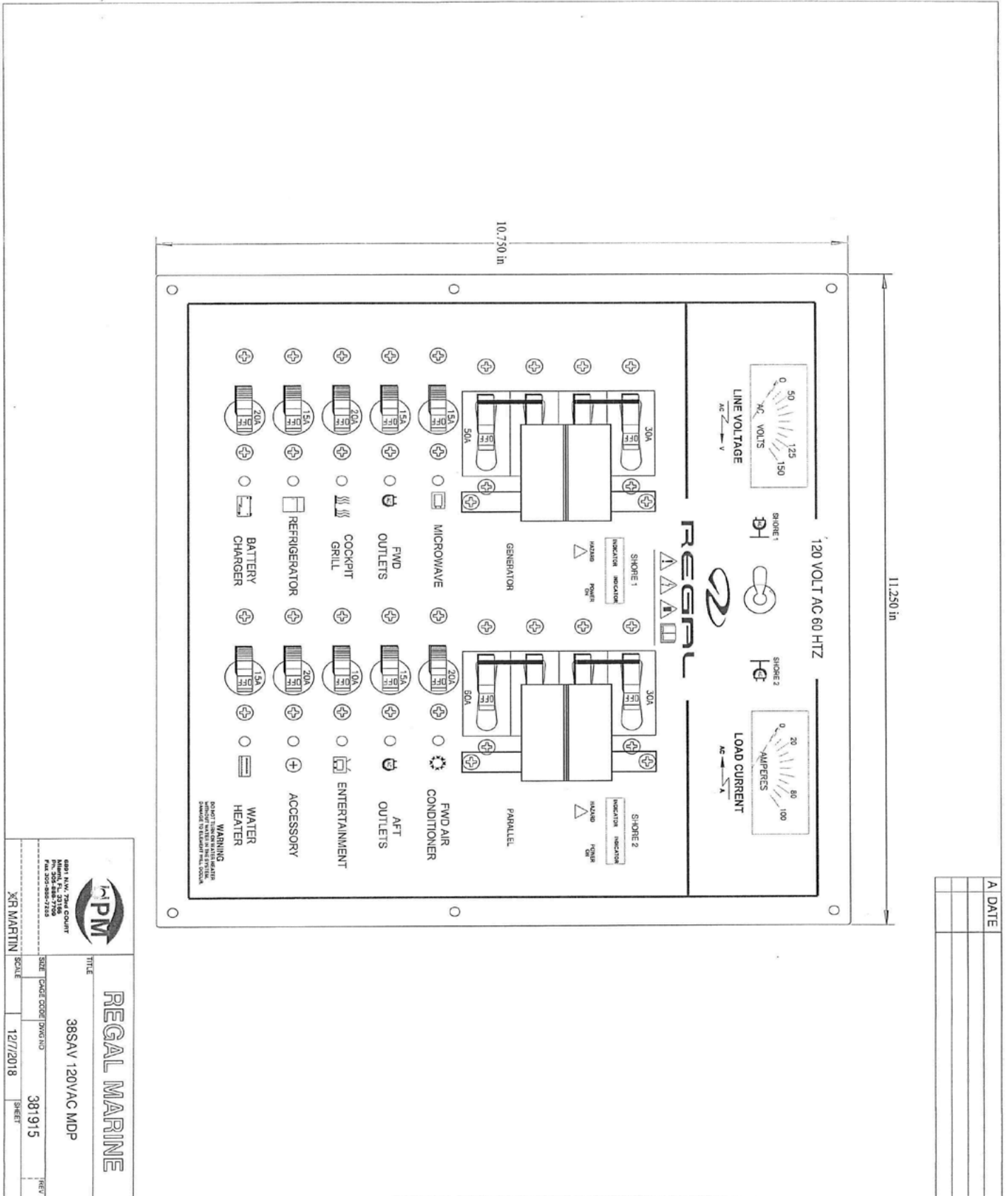

A	DATE

MPM
 MARINE POWER MANAGEMENT
 4800 N.W. 72nd COURT
 FIVE FLOORS
 FIVE 2000 BLDG. 7700
 MIAMI, FL 33154
 TEL: 305-553-7700
 FAX: 305-553-7700

REGAL MARINE

TITLE: 38SSAV 120VAC MDP

SCALE: 12/7/2018 SHEET: 381915

DESIGNER: XJR MARTIN



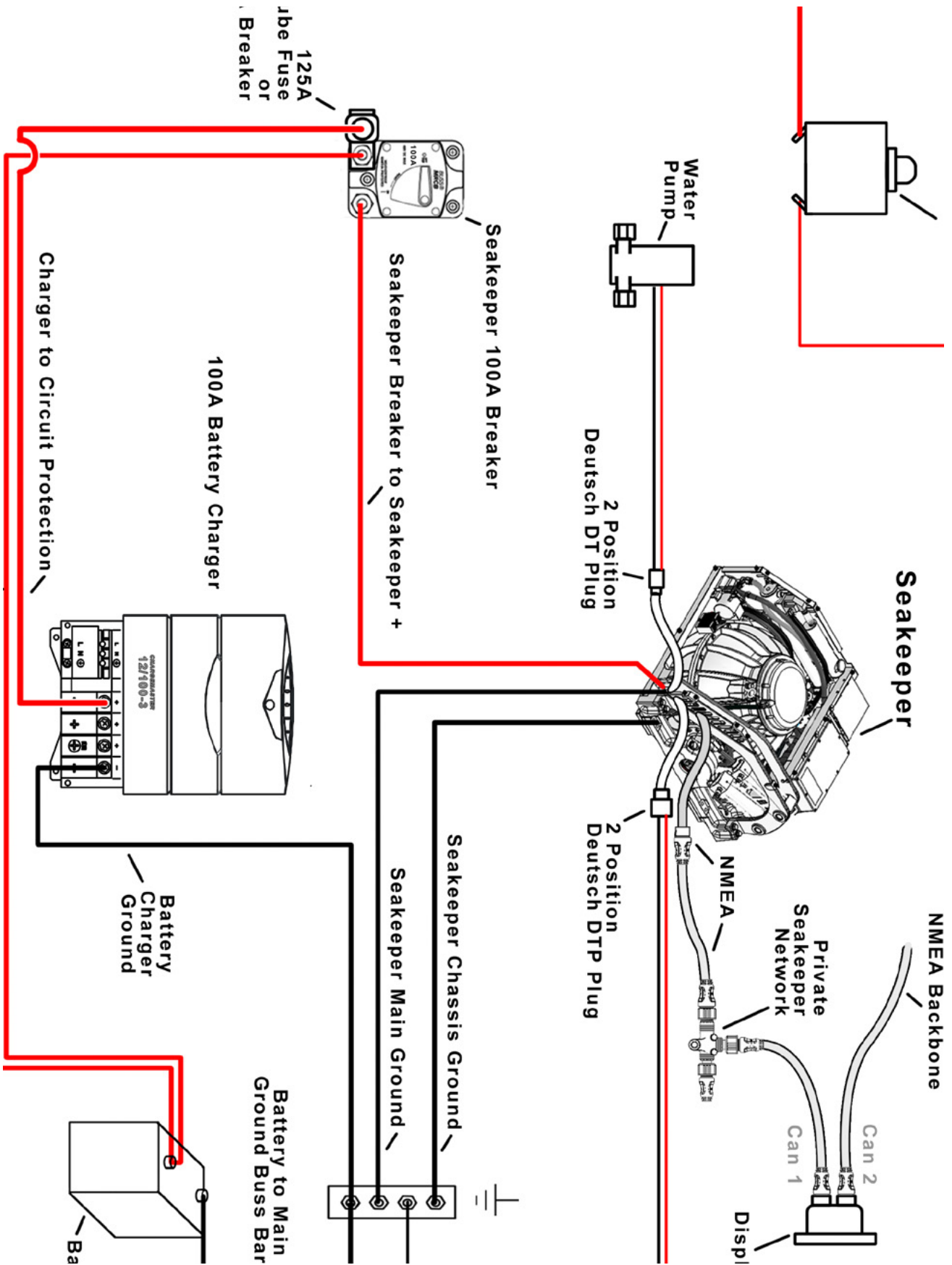



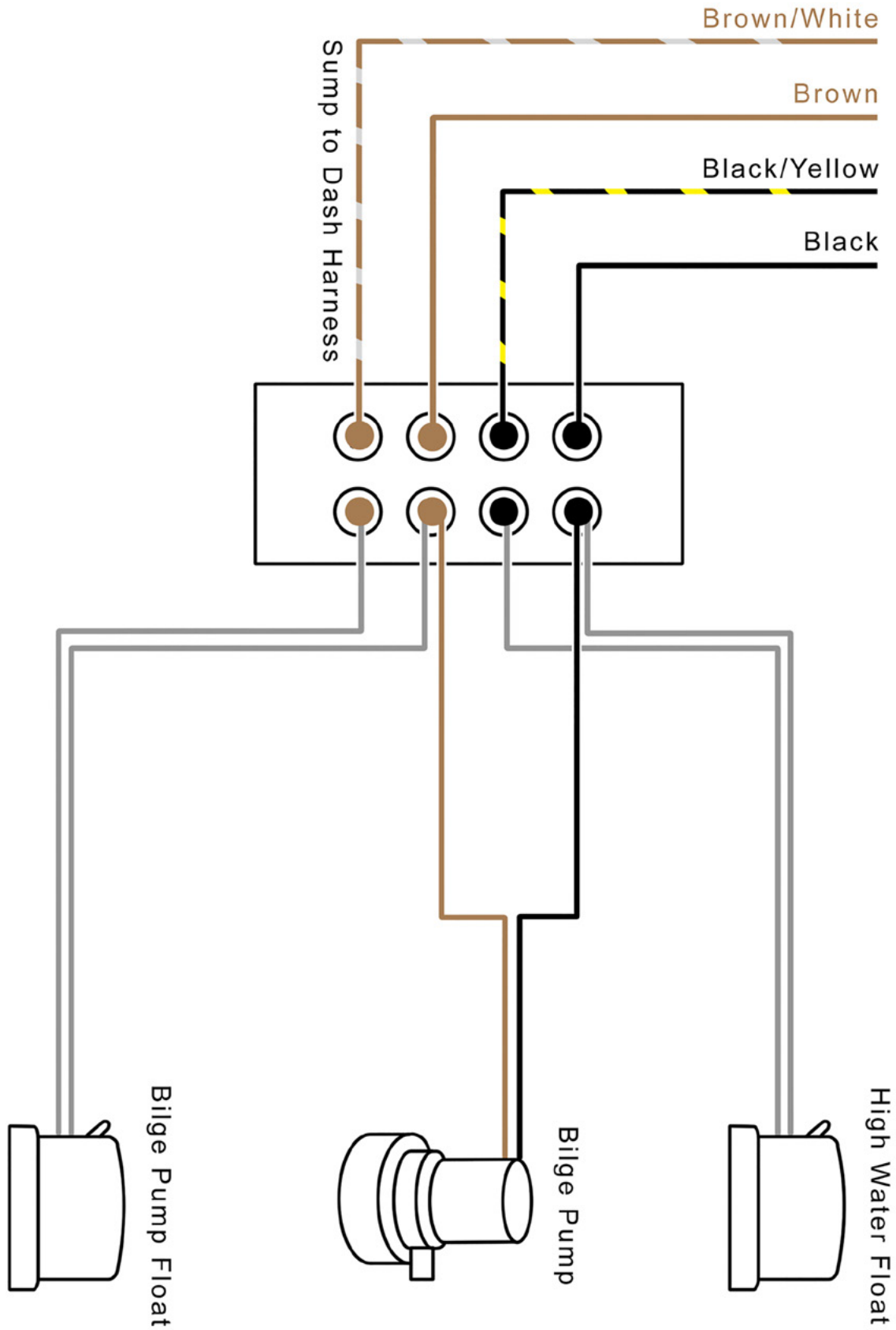



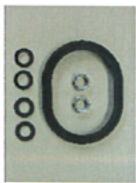









SEAKEEPER WIRING

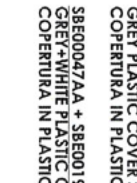

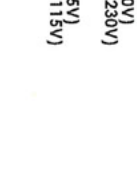
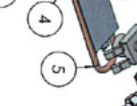
SUMP BILGE PUMP/FLOAT SWITCH WIRING

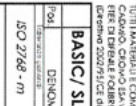

WATER HEATER COMPONENTS/FUNCTIONS

	<p>1 SEAD000411LA SERVICE THERMOSTAT TERMOSTATO DI SERVIZIO</p>		<p>6 SDF00025AA GASKETS KIT KIT GUARNIZIONI</p>		<p>10 SGB00049AA FIXING BRACKET KIT SLIM 15/20/25 L KIT FLANGIA FISSAGGIO SLIM 15/20/25L.</p>
	<p>2 SEAD00042LA SAFETY THERMOSTAT TERMOSTATO DI SICUREZZA</p>		<p>7 SFD00023AA LK 514 SAFETY VALVE 7.0 KP/cm VALVOLA DI SICUREZZA LK514 7BAR</p>		<p>11 SGB00096AA POWER CABLE WITH EU PLUG CAVO ALIMENTAZIONE CON SPINA EU</p>
	<p>3 SDF00018AA GASKET FOR FLANGE GUARNIZIONE FLANGIA</p>		<p>8 SFD00011AA MIXING VALVE LK550 VALVOLA MISCELATRICE LK550</p>		<p>11 SGB00073AA POWER CABLE WITH UK PLUG CAVO ALIMENTAZIONE CON SPINA UK</p>
	<p>4 SBE00045AA FLANGE FOR ELEMENT STAFFA RESISTENZA</p>		<p>9 SBE00095AA GREY PLASTIC COVER SLIM WATER HEATERS SLIM INOX 15-20-25L COPERTURA IN PLASTICA GRIGIA BOILER SLIM INOX 15-20-25L</p>		<p>11 SGB00080AA POWER CABLE WITH USA PLUG CAVO ALIMENTAZIONE CON SPINA USA</p>
	<p>5 SEE000191A HEATING ELEMENT 230V/750W WITH GASKET (STANDARD 230V) KIT RESISTENZA 230V/750W CON GUARNIZIONI (STANDARD 230V)</p>		<p>9 SBE00047AA + SBE00199AA GREY/WHITE PLASTIC COVER BASIC WATER HEATERS BASIC INOX 24-30-40-50-75L COPERTURA IN PLASTICA GRIGIA + BIANCA BOILER BASIC INOX 24-30-40-50-75L</p>		<p>11 SGB00080AA POWER CABLE WITH USA PLUG CAVO ALIMENTAZIONE CON SPINA USA</p>
	<p>5 SEE00014HA HEATING ELEMENT 115V/750W WITH GASKET (STANDARD 115V) KIT RESISTENZA 115V/750W CON GUARNIZIONI (STANDARD 115V)</p>		<p>9 SBE00047AA + SBE00199AA GREY/WHITE PLASTIC COVER BASIC WATER HEATERS BASIC INOX 24-30-40-50-75L COPERTURA IN PLASTICA GRIGIA + BIANCA BOILER BASIC INOX 24-30-40-50-75L</p>		<p>11 SGB00080AA POWER CABLE WITH USA PLUG CAVO ALIMENTAZIONE CON SPINA USA</p>
	<p>5 SEE00015LA HEATING ELEMENT 230V/1200W WITH GASKET (OPZ. ONLY FOR SLIM VERSION 20-25L - BASIC VERSION 40-50-75L) KIT RESISTENZA 230V/1200W CON GUARNIZIONI (OPZ. SOLO PER SLIM 20-25L - BASIC 40-50-75L)</p>		<p>9 SBE00047AA + SBE00199AA GREY/WHITE PLASTIC COVER BASIC WATER HEATERS BASIC INOX 24-30-40-50-75L COPERTURA IN PLASTICA GRIGIA + BIANCA BOILER BASIC INOX 24-30-40-50-75L</p>		<p>11 SGB00080AA POWER CABLE WITH USA PLUG CAVO ALIMENTAZIONE CON SPINA USA</p>
	<p>5 SEE00023HA HEATING ELEMENT 115V/1200W WITH GASKET (OPZ. ONLY FOR SLIM VERSION 20-25L - BASIC VERSION 40-50-75L) KIT RESISTENZA 115V/1200W CON GUARNIZIONI (OPZ. SOLO PER SLIM 20-25L - BASIC 40-50-75L)</p>		<p>9 SBE00047AA + SBE00199AA GREY/WHITE PLASTIC COVER BASIC WATER HEATERS BASIC INOX 24-30-40-50-75L COPERTURA IN PLASTICA GRIGIA + BIANCA BOILER BASIC INOX 24-30-40-50-75L</p>		<p>11 SGB00080AA POWER CABLE WITH USA PLUG CAVO ALIMENTAZIONE CON SPINA USA</p>

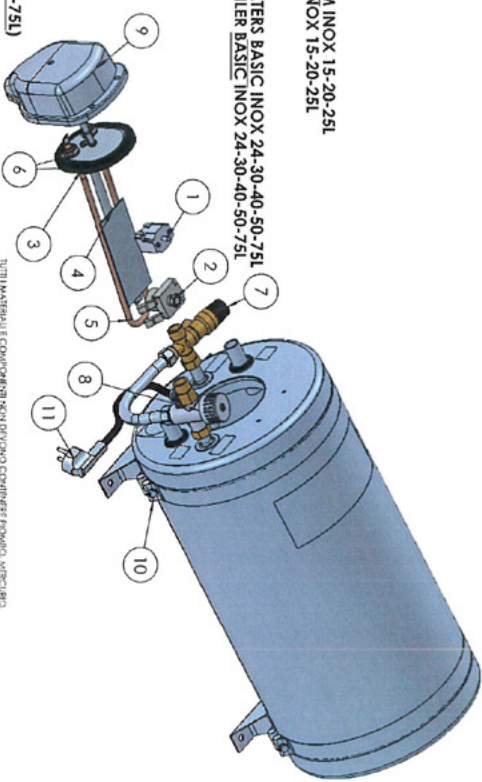

TUTTI I MATERIALI E I COMPONENTI SONO DI ORIGINE CERTIFICATA. VERIFICARE PER IL MODELLO E IL MODELLO. PER INFORMAZIONI SULLE CARATTERISTICHE E LE CONDIZIONI DI UTILIZZO, CONSULTARE IL MANUALE D'ISTRUZIONI. PER INFORMAZIONI SULLE CARATTERISTICHE E LE CONDIZIONI DI UTILIZZO, CONSULTARE IL MANUALE D'ISTRUZIONI.

BASIC/ SLIM WATER HEATERS

Model	DESIGNAZIONE	Modello	Stato/URILE	Base	Capacità
ISO 2746 - 01	CHINA				1/10

Per informazioni sui servizi clienti, visitate il sito www.termotecnica.com o chiamate il numero verde 800 20 20 20.

Il servizio clienti è disponibile dal lunedì al venerdì, dalle 9 alle 18 ore.

Il servizio clienti è disponibile dal lunedì al venerdì, dalle 9 alle 18 ore.

UPHOLSTERY IDENTIFIER

38SAV SV UPH UPHOLSTERY IDENTIFIER				
Bundle	Assembly	Description	Sub	Vinyl
1	USV06A	BOW CENTER COAMING		
2	USV06B	BOW FWD PORT CUSHION		
3	USV06C	BOW FWD CENTER CUSHION		
4	USV06D	BOW FWD STBD CUSHION		
5	USV06E	BOW STBD COAMING		
6	USV06F	BOW STBD CUSHION		
7	USV06G	BOW AFT STBD UPPER BACKREST		
8	USV06H	BOW ARMREST		
9	USV06J	BOW PORT LOWER AMREST		
10	USV06K	BOW AFT CENTER UPPER BACKREST		
11	USV06L	BOW STBD LOWER ARMREST		
12	USV06M	BOW AFT CENTER LOWER BACKREST		
13	USV06N	BOW FILLER CUSHION		
14	USV06P	BOW AFT PORT CUSHION		
15	USV06Q	BOW AFT STBD CUSHION		
16	USV06R	BOW CENTER LOWER BACKREST		
17	USV06S	BOW AFT STBD LOWER BACKREST		
18	USV06T			
19	USV12A	DASH VISOR		
20	USV13A	HELM SEAT		
21	USV15A	COCKPIT UPPER BACKREST		
22	USV15B	COCKPIT LOWER BACKREST		
23	USV15C	COCKPIT ARMREST		
24	USV15D	COCKPIT STBD LOWER ARMREST		
25	USV15E	COCKPIT PORT LOWER ARMREST		
26	USV15F	COCKPIT PORT CUSHION		
27	USV15G	COCKPIT CENTER CUSHION		
28	USV15H	COCKPIT STBD CUSHION		
29	USV15J	COCKPIT FWD PORT COAMING		
30	USV15K	COCKPIT AFT PORT COAMING		
31	USV15L	COCKPIT STBD COAMING		
32	USV15M	T.V. PANEL		
33	USV17A	ENGINE HATCH CUSHION PANEL		
34	USV17B	ENGINE HATCH CUSHION		
35	USV17C	ENGINE HATCH BACKREST		
36	USV17D	ENGINE HATCH TABLE HOLDER		
37	USV18A	BOW FWD SPAGHETTI MAT		
38	USV18B	BOW STBD SPAGHETTI MAT		
39	USV18C	COCKPIT SPAGHETTI MAT		

*Note that the identifier can be used to assist in ordering upholstery needs throughout the life of the vessel