



**REGAL  
OWNER'S MANUAL  
LS2, LS2 SURF, LX2**

 **REGAL**

AUGUST 2019 EDITION

# Important Notes

## FUEL SYSTEMS

Boats manufactured for use in California for model year 2018 and after meet the California EVAP Emissions regulation for spark-ignition marine watercraft. Boats meeting this requirement will have a label affixed near the helm.



## WARNING

Operating, servicing and maintaining a recreational marine vessel can expose you to chemicals including engine exhaust, carbon monoxide, phthalates, and lead, which are known to the State of California to cause cancer and birth defects or other reproductive harm. To minimize exposure, avoid breathing exhaust, service your vessel in a well-ventilated area and wear gloves or wash your hands frequently when servicing this vessel. For more information go to: [www.P65warnings.ca.gov/marine](http://www.P65warnings.ca.gov/marine).

The fuel system in this boat complies with U.S. EPA mandated evaporative emission standards at time of manufacture using certified components.

## MANUFACTURER'S WARRANTY COVERAGE

This evaporative emission control system is warranted for two years. If any evaporative emission-related part on your spark-ignition marine watercraft is defective, the part will be repaired by Regal Marine Industries, Inc.

## OWNER'S MANUAL RESPONSIBILITIES

- As the spark-ignition marine watercraft owner, you are responsible for the performance of the required maintenance listed in your owner's manual. Regal Marine Industries, Inc. recommends that you retain all receipts covering maintenance on your spark-ignition marine watercraft, but Regal Marine Industries, Inc. cannot deny warranty solely on the lack of receipts.
- As the owner, you should be aware that Regal Marine Industries, Inc. may deny you warranty coverage of your spark-ignition marine watercraft or a part has failed due to abuse, neglect, or improper maintenance or unapproved modifications.
- You are responsible for presenting your spark-ignition marine watercraft to a Regal Marine Industries, Inc. distribution center or a service center as soon as the problem exists. The warranty repairs should be completed in a reasonable amount of time, not to exceed 30 days. If you have any questions regarding your warranty coverage, you should contact Regal Marine Industries, Inc. at 407-851-4360.

# Introduction

Boating is becoming more popular each and every year. There are numerous types of recreational vessels on our waterways today involved in an every growing number of activities. Therefore, as a Regal boat owner it is of the highest priority to learn about general boating practices before operating your vessel.

Your Regal dealer will answer many questions and provide valuable “hands on” information during the completion of the new boat delivery process. In addition, your dealer has received special factory training on the product line and his services should be employed to solve any technical problems and periodic maintenance beyond the scope of this manual. Your Regal dealer carries a line of factory approved parts and accessories.

Your Regal dealer can provide information regarding national training organizations such as the U.S. Power Squadron and United States Coast Guard Auxiliary. Along with other organizations and literature, they can help build your “boating savvy” by developing the necessary skills and awareness to be a safe and confident skipper.

Also, your local library can assist in providing recommended boating literature such as Chapman Piloting Seamanship & Boat Handling by Elbert S. Maloney. Also, boating information is available on the internet.

Remember, waterway conditions can change in a heartbeat. Knowing how to react quickly comes from experience and knowledge which can be gained through boating education.

Welcome aboard!

# Welcome to Regal

I know I speak for everyone at Regal when I welcome you to the ever-growing family of Regal boat owners. You've chosen a boat that is recognized worldwide for its standard of excellence. Each step in construction has been carefully scrutinized to assure safety, performance, reliability and comfort for both your passengers and yourself.

Your yacht is certified by the National Marine Manufacturers Association. It also complies with the applicable standards set by the United States Coast Guard , American Boat and Yacht Council and the International Marine Certification Institute. Your Regal boat was built with the same attention to detail and quality of construction that we would expect in a craft we would purchase ourselves.

Whether you're a veteran boater or a newcomer, we strongly urge you to read this owner's manual thoroughly. Familiarize yourself with the various components of your vessel, and heed the safety precautions noted herein.

If you have questions that are not covered in this manual, please consult your authorized Regal dealer for assistance, phone the Regal factory at 407-851-4360 or E-mail us at [www.regalboats.com](http://www.regalboats.com).

Thank you, and welcome to the "World of Regal !"

Duane Kuck  
President & CEO

## Our Mission

With God's Help and a Steadfast Commitment to Integrity, We will Develop a Team of Exceptional People and Relationships to Provide Exceptional Customer Satisfaction.



# Table Of Contents

<b>2</b>	Notes
<b>3</b>	Introduction
<b>4</b>	Welcome to Regal
<b>6</b>	Chapter 1 - General Vessel Information
<b>18</b>	Chapter 2 - Safety On Board
<b>41</b>	Chapter 3 - Rules Of The Road
<b>51</b>	Chapter 4 - Systems
<b>76</b>	Chapter 5 - Engine & Controls
<b>76</b>	LS2 Stern Drive Engine & Systems
<b>89</b>	LS2 Surf Engine & Systems
<b>98</b>	LX2 Outboard Engine & Systems
<b>130</b>	Chapter 6 - Vessel Operation
<b>145</b>	Chapter 7 - Auxiliary Equipment Operation
<b>169</b>	Chapter 8 - Care & Maintenance
<b>185</b>	Chapter 9 - Troubleshooting
<b>193</b>	Chapter 10 - Storage & Winterization
<b>197</b>	Chapter 11- Towing
<b>202</b>	Chapter 12- Glossary & Index
<b>208</b>	Chapter 13 - Technical

# Chapter 1

## General Vessel Information

### Regal Owner's Manual

Your Regal owner's manual has been compiled with information to assist you in operating your craft with safety and pleasure. This manual targets specific details of Regal related systems and components along with their location, operation and maintenance that normally are not found in the vendor information. **Note that chapter 5 devotes special sections to stern drive, surf, and out-board propulsion. For more detail refer to the engine manufacturer's engine manual.**

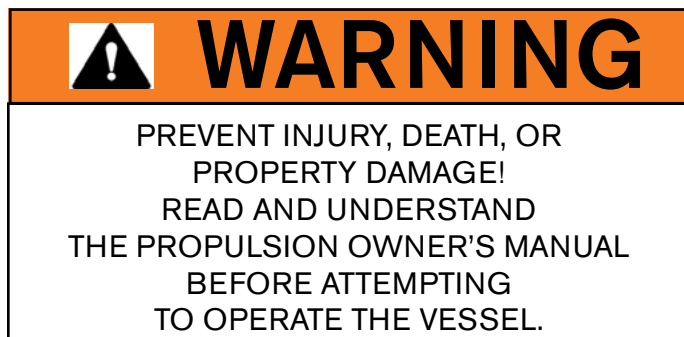

The Regal owner's manual is not to be thought of as a complete shop manual. Besides the system chapters, there is troubleshooting information devoted to select current standard and optional equipment. In addition, refer to the engine operator's manuals. More detailed information may exist in the owner's packet associated with that component.

Remember that your Regal dealer has received special factory training and his services should be employed to solve more technical problems.

Call 407-851-4360 or go to the internet at [regalboats.com](http://regalboats.com) to find the closest Regal dealership.

*In keeping with its commitment to improvement Regal Marine Industries, Inc. is continually upgrading the product line. Regal notes that all dimensions, specifications, models, standard and optional equipment is subject to change without notice at any time.*

### Regal Owner's Manual

Currently there is a QR label attached to a visible location close to the helm. This label when scanned



by an I phone will take you via an app to the Regal web-site where you can download your vessel's owner's manual or for that matter any Regal owner's manual.

With the manual downloaded you can duplicate it into a format you are comfortable using. The QR label is used globally for any type product from the food, home and auto business to boats. It affords much more capacity and is much more customer friendly than the traditional bar code used by other manufacturer's on their products.

*Other Regal owner's manuals can be found by scanning this QR Code or by going to:*

[regalboats.com/owners](http://regalboats.com/owners)

## Owner's Information Packet



An owner's information packet (black satchel) is located on the vessel. Read and become familiar with the materials.

This packet contains valuable information on your propulsion package, standard and optional equipment, systems, care and maintenance along with component warranty. Store the information packet in a clean, dry location on board your vessel.

## Vessel Information Sheet

It is recommended that you fill out the information on the following page. It will supply vital statistics on your vessel. Make a copy of the data for safe keeping at home.

## NMMA Capacity Plate

Near the helm on domestic vessels is an NMMA (National Marine Manufacturer's Association) capacity label. It specifies the total number of persons and the total amount of weight in persons and gear. Example below.

**MAXIMUM CAPACITIES**  
**12 PERSONS OR 1640 LBS.**  
1640 POUNDS, PERSONS, GEAR

THIS BOAT COMPLIES WITH U.S. COAST GUARD SAFETY STANDARDS IN EFFECT ON THE DATE OF CERTIFICATION  
MEETS U.S. EPA EVAP STANDARDS USING CERTIFIED COMPONENTS  
MANUFACTURER: REGAL MARINE INDUSTRIES, INC.  
MODEL: LS2 ORLANDO, FL

DESIGN COMPLIANCE WITH NMMA REQUIREMENTS IS VERIFIED.  
MANUFACTURER RESPONSIBLE FOR PRODUCTION CONTROL.

**NMMA**  
CERTIFIED  
by ABYC standards

NATIONAL MARINE  
MANUFACTURERS ASSOCIATION

## Hull Identification Number

The United States Coast Guard has established a universal system of numerically recognizing vessels by using a hull identification number or "HIN." This number identifies your Regal yachts' model, hull number, month and year of manufacture. The



HIN is normally found on your boat's transom, on the starboard side, just below the rub rail on

the transom vertical surface. The HIN is stamped on a plate and reinforced with a special adhesive. The HIN domestically uses 12 alpha or numeric characters.

It is recommended that you locate and write down the HIN for future reference. It can be especially useful when ordering parts from your Regal dealer. A second HIN number is found in a hidden location. This second HIN is useful to authorities if the vessel is stolen and/or the original transom HIN is modified or eliminated.

## Vessel Float Plan

Formulate the float plan on the following page before departing. Leave it with a responsible person who will notify the United States Coast Guard or local law enforcement authorities if you do not return as planned. If you change your plans be sure to notify this person. Make copies of the float plan and use one each time you go boating. This will help people know where to find you should you not return on schedule. Do not file the float plan with the United States Coast Guard.

## Vessel Information Sheet

Owner: \_\_\_\_\_

Address: \_\_\_\_\_

City & State: \_\_\_\_\_

Home Phone: \_\_\_\_\_ Business Phone: \_\_\_\_\_

In Case Of Emergency Notify: \_\_\_\_\_

Address \_\_\_\_\_

\_\_\_\_\_

City & State \_\_\_\_\_

Phone \_\_\_\_\_

Insurance Agent's Name: \_\_\_\_\_

Policy#: \_\_\_\_\_

USCG Phone: \_\_\_\_\_ Local Police: \_\_\_\_\_

Marina Phone: \_\_\_\_\_ Slip (Dock#): \_\_\_\_\_

Hull Serial #: RGM \_ \_ \_ \_ \_

Key #: \_\_\_\_\_ Engine: \_\_\_\_\_

Selling Dealer: \_\_\_\_\_

Address: \_\_\_\_\_

City & State: \_\_\_\_\_

Phone: \_\_\_\_\_ Fax: \_\_\_\_\_

Servicing Dealer: \_\_\_\_\_

Address: \_\_\_\_\_

City & State: \_\_\_\_\_

Phone: \_\_\_\_\_ Fax: \_\_\_\_\_

## Vessel Float Plan

Fill out this form before departure. Leave it with a responsible person who will notify the Coast Guard or police if you don't return as planned. If you change your plans be sure to notify this person. Make copies of the float plan and use one each time you go on a trip. This will help people know where to find you should you not return on schedule. *Do not file this plan with the Coast Guard.*

Owner: \_\_\_\_\_  
 Address: \_\_\_\_\_  
 City & State: \_\_\_\_\_  
 Telephone#: \_\_\_\_\_  
 \_\_\_\_\_  
 \_\_\_\_\_

Person Filing Report: \_\_\_\_\_  
 Name \_\_\_\_\_  
 Telephone \_\_\_\_\_  
 \_\_\_\_\_  
 \_\_\_\_\_

Make Of Craft: \_\_\_\_\_  
 Length \_\_\_\_\_ Boat Name \_\_\_\_\_  
 Color \_\_\_\_\_ Trim \_\_\_\_\_ Hp \_\_\_\_\_  
 Inboard \_\_\_\_\_ Stern Drive \_\_\_\_\_  
 Hull I.D.# \_\_\_\_\_  
 Documented Vessel # \_\_\_\_\_  
 \_\_\_\_\_

Other Information \_\_\_\_\_  
 \_\_\_\_\_  
 \_\_\_\_\_  
 \_\_\_\_\_  
 \_\_\_\_\_

Safety Equipment Aboard: \_\_\_\_\_  
 Life Jackets \_\_\_\_\_  
 First Aid Kit \_\_\_\_\_  
 Flares \_\_\_\_\_  
 Flash Light \_\_\_\_\_  
 VHF Radio \_\_\_\_\_  
 Cell Phone \_\_# \_\_\_\_\_  
 Computer \_\_Desk Top \_\_\_\_Lap Top\_\_\_\_  
 E-mail address \_\_\_\_\_  
 Food \_\_\_\_\_Water \_\_\_\_\_

State Registration# \_\_\_\_\_  
 Destination: \_\_\_\_\_  
 Leave From \_\_\_\_\_  
 Time Left \_\_\_\_\_  
 Going To \_\_\_\_\_  
 Fuel Capacity \_\_\_\_\_  
 Est. Day Of Arrival \_\_\_\_\_  
 \_\_\_\_\_  
 Est. Time Of Arrival \_\_\_\_\_  
 If Not Back By \_\_\_\_\_ o'clock Call Authorities

### Persons Aboard:

Name	Age	Address	Phone
_____	_____	_____	_____
_____	_____	_____	_____
_____	_____	_____	_____
_____	_____	_____	_____
_____	_____	_____	_____

\_\_\_\_ See Other Side For Additional Persons

## Vessel Cruise Checklist

- Obtain a current weather update.
- Hoist the boat & periodically inspect the hull bottom and propellers for damage. Marine growth such as barnacles will affect performance and fuel efficiency. Check sacrificial anodes located on the propulsion unit, transom and engine. Replace anode if less than 2/3 remaining.
- Check the electrical system and all safety related equipment. Carry extra fuses. Ensure they are of the proper capacity and type.
- If your boat has been in the water, run the bilge pump until the flow of water stops.
- Check to see that all bilge water has drained and the drain plug is installed before launching If your boat if it has been out of the water.
- Check that all required safety equipment is on board and in good working condition Examples include personal flotation devices (PFD's), horn, bell, hand held fire extinguishers, and visual distress signals.
- Check fuel level. Fuel tanks should be filled to slightly less than capacity. Allow for fuel expansion. Remember the "one third rule".
- Open engine compartment. Inspect for fuel odors and visible leaks in the fuel, oil, coolant, exhaust and power steering systems.
- Check all fuel filters for the presence of water.
- Check fluid levels of engines, drives and generator (if applicable).
- Inspect engine for cracked hoses, worn or loose belts, and loose hardware.

## **Recommended On Board Equipment**

### **Tools:**

Allen Wrenches  
Jack Knife  
Phillips Screwdriver  
Regular & Needle Nose Pliers  
Combination Box & End Wrench Set  
Screwdriver Set (One With Various Tips)  
Side Cutters  
Ratchet & Socket Set  
Electrical Crimper,Cutter,Stripper Combo  
Hammer  
VOA Electrical Tester  
Water Pump Pliers  
Vise Grip Pliers  
Floating Flashlight/Lantern  
Oil/Fuel Filter Wrench  
Tape Rule

### **Basic Gear & Supplies:**

Tow Line  
Lubricating Oil, Liquid Wrench  
Mooring Lines  
Duct & Electricians Tape  
Dock Fenders  
Coolant (Engine Freshwater Side)  
Distress Signals  
Engine, Drive, Power Steering Oil  
First Aid Kit  
Boat Soap (Not Dish Soap)  
Boat Hook  
Woody Wax  
Charts & Plotting Instruments  
Back-up  
Vinyl Cleaner  
Emergency Food & Water  
Hydrogen Peroxide (AC Pans)  
EPIRB

### **Spare Parts:**

Fuel Filters-Engines & Generator  
Poly V- Belt (See Engine Manual)  
Coolant For Engine Freshwater System  
Extra Light Bulbs  
Seawater Filter  
Fuses  
Propeller Set (See Dealer)  
Propeller Hardware  
Flashlight Batteries  
Engine Spare Parts  
Generator Spare Parts  
Air Filters-Engine & Generator  
Oil Filters-Engine, Generator  
Drive Oil Filters

Life Raft  
Bailer or Hand Pump  
Rust Stain Remover (Star Brite)  
Extra Hand Held Fire Extinguishers  
Corrosion Block  
Personal Floatation Devices  
Bilge Cleaner  
Clean Rags, Diapers  
(For Under Engine-Oil Leaks)  
Nylon Windbreaker Suit  
Sunscreen (SPF 30+)  
Shop Vacuum (1 Gal. Cap. Wet-Dry)  
Bucket/Pans w/Lids-Draining/Storing  
Used Fluids  
Squeegee  
Mirror (For Inspection & Emergency Signaling)  
Binoculars

## **Owner's Registration & Systems**

Please note that your boat requires the proper registration by your authorized Regal dealer. To initiate the vessel warranty your dealer must complete the owner's registration form and systems checklist at the time of delivery. The owner must sign the paperwork to acknowledge that the dealer has reviewed the boat systems and warranty provisions with the owner. The owner should keep the original paperwork that features a temporary warranty registration. A warranty certificate will be sent approximately 6 weeks after receipt of the paperwork at Regal World Headquarters.

## **Dealer's Responsibility**

Your vessel has undergone rigid quality assurance inspections before leaving the factory. In addition, your dealer has been trained to perform final pre-delivery checks and to service your Regal boat.

Your dealer's responsibilities include:

1. An orientation in the operation of your Regal boat including matters relating to the safe operation of the vessel.
2. Completion and mailing of your boat registration warranty form to Regal.
3. Location of vendor warranties, registration materials, owner's manual, operation, installation and maintenance instructions for auxiliary equipment supplied with or installed on your Regal boat.

## **Owner's Responsibility**

You are entitled to all the benefits and services outlined in your Regal warranty. However, you have certain responsibilities to ensure warranty satisfaction. These are:

To read the warranty materials and understand them fully.

To examine the vessel in detail at the time of delivery.

To apply the following: boating rules and regulations, safety equipment, environmental regulations, accident reports and warranty regulations terms and conditions.

To read thoroughly all literature supplied with your boat including this owner's manual and to follow the recommendations in the literature.

To provide proper maintenance and periodic servicing of your boat and equipment as set forth in the various manuals supplied.



## Customer Service

Take the time to write down your Regal dealer's phone number and E-mail address for future reference. Along with your Regal dealer information is a listing below of other phone numbers and web addresses which may prove useful.

Regal Dealer:

Phone: \_\_\_\_\_

E-mail: \_\_\_\_\_

Regal Marine Customer Service:

1-800-US REGAL (1-800-877-3425)

regal@regalboats.com

customer.service@regalboats.com

# REGAL MARINE INDUSTRIES, INC. LIMITED WARRANTY

Welcome to the Worldwide Family of Regal Owners! We are very pleased that you have chosen a Regal Powerboat!

This document is your Limited Warranty Registration Certificate and Statement of Limited Warranty. Please check the registration information section for accuracy. If this information is not correct or if you change your address at some future date, please notify us at the following address: Regal Marine Industries, Inc. Attention: Warranty Registrations, 2300 Jetport Drive, Orlando, Florida 32809; or e-mail [customerservice@regalboats.com](mailto:customerservice@regalboats.com).

Please read the warranty carefully. It contains important information on Regal's claims procedures and your rights and obligations under this warranty.

**WHAT IS COVERED:** This Limited Warranty applies only to Regal boats beginning with model year 2017.

**LIFETIME LIMITED STRUCTURAL DECK & HULL WARRANTY:** Regal Marine Industries, Inc. warrants to the original retail purchaser of this boat if purchased from an authorized Regal dealer that the selling dealer or Regal will repair or replace the factory installed fiberglass if it is found to be structurally defective in material or workmanship for as long as the original retail purchaser owns the boat. For purposes of this Limited Warranty, the hull is defined as the single fiberglass casting which rests on the water. This Limited Warranty is subject to all limitations and conditions explained below.

**FIVE-YEAR TRANSFERABLE LIMITED STRUCTURAL HULL WARRANTY:** In addition to the Lifetime Limited Structural Hull Warranty, Regal offers a Transferable Five-Year Limited Structural Hull Warranty. Under the Five-Year Transferable Limited Structural Hull Warranty, Regal will repair or replace the fiberglass hull or deck if it is found to be structurally defective in material or workmanship within the first (5) years after the date of delivery to the original retail purchaser. Any remaining term of this Five-Year Limited Hull Warranty may be transferred to a second owner if within 60 days of purchase, the new owner registers the transfer with Regal and pays the established Limited Warranty transfer fee. Contact Regal Customer Service at the above address for details.

**FIVE-YEAR LIMITED HULL BLISTER WARRANTY:** Regal warrants that the Regal selling dealer or Regal will repair any underwater gelcoated surfaces of the hull against laminate blisters which occur as a result of defects in material or workmanship within (5) years of the date of delivery, provided that the original factory gelcoat surface has not been altered. Alternation would include but is not limited to damage repair; excessive sanding, scraping, sandblasting; or from improper surface preparation for application of a marine barrier coating or bottom paint, any of which shall void this Five-Year Limited Hull Blister Warranty. Proper preparation must be applied to the hull bottom if the boat is to be moored for periods in excess of (60) days. Regal Marine shall repair or cause to be repaired any covered laminate blisters based on the following prorated schedule. Less than three (3) years from delivery date - 100%, Three (3) to (4) years from delivery date - 50%, Four (4) to (5) years from delivery date - 25%.

Reimbursement shall be limited to one repair, not to exceed (\$100.00) dollars per foot of boat length prior to prorating. Regal's prior authorization for the method and cost of repair, must be obtained before repairs are commenced. All costs to transport the boat for repairs are the responsibility of the owner.

**LIMITED GENERAL WARRANTY:** In addition to above hull warranties, Regal warrants to the original purchaser of this boat if purchased from an authorized Regal dealer, that the authorized Regal dealer or Regal will repair or replace any parts found to be defective in materials or workmanship for a period of one (1) year from the date of delivery, subject to all exceptions, limitations and conditions contained herein.

**LIMITED EXTERIOR FINISH WARRANTY:** Regal warrants that the authorized Regal selling dealer or Regal will repair cosmetic defects in the exterior gelcoated finish including cracks, air voids or crazing for one year from the date of delivery, subject to all limitations and conditions contained herein. All warranty work is to be performed at a Regal dealership or other location authorized by a Regal Customer Service Manager after it is established to Regal's satisfaction that there is a defect in material or workmanship.

**CUSTOMER OBLIGATIONS:** The following are conditions precedent to the availability of any benefits under these limited warranties:

(a) The purchaser, who is not Regal's sales agent and is otherwise not in any general or sales agency relationship with Regal, must sign and the authorized Regal selling dealer, must submit to Regal the "NEW BOAT DELIVERY and ACCEPTANCE CHECKLIST" within fifteen (15) days of the date of delivery and such information must be on file at Regal.

(b) The purchaser must first notify the authorized Regal selling dealer from whom the boat was purchased of any claim under this Limited Warranty within the applicable Limited Warranty period and within a reasonable period of time (not to exceed thirty (30) days) after the defect is or should have been discovered.

(c) Regal will not be responsible to repair any condition or replace any part, (1) if the use of the boat is continued after the defect is or should have been discovered; and (2) if such continued use causes other or additional damage to the boat or component parts of the boat.

(d) Based on the authorized Regal selling dealer's knowledge of Regal's Limited Warranty policy and/or consultations with Regal, the dealer will accept the claim and arrange for appropriate repairs to be performed, or deny the claim if it is not within the Limited Warranty policy.

(e) The authorized Regal selling dealer will contact the Regal boat owner regarding instructions for delivery of boat or part for covered warranty repair if it is covered by the Limited Warranty.

**ALL COSTS TO OR FROM THE BOAT AND/OR TRANSPORT OF THE BOAT FOR REPAIRS ARE THE RESPONSIBILITY OF THE OWNER.**

(f) If the Regal boat owner believes a claim has been denied in error or the authorized Regal selling dealer has performed the warranty work in an unsatisfactory manner, the owner must notify Regal's Customer Service Department in writing at the address listed for further consideration. Regal will then review the claim and take appropriate follow-up action.

(g) Before bringing any action, claim, lawsuit, or otherwise seeking relief against Regal based on any alleged breach of any of the Limited Warranties, terms or conditions herein, the Regal Boat owner must contact Regal's Customer Service Department Directly allow Regal, beyond those efforts made by its authorized Regal dealer, notice an opportunity to cure any alleged breach of any of the terms of any of the Limited Warranties.

**WARRANTY EXCEPTIONS:** THIS LIMITED WARRANTY does not cover, the following are not warranted are excluded from the terms of the Regal Limited Warranty and the following terms apply to any Regal Limited Warranty.

- (a) Engines, drives, controls, propellers, batteries, metal plating or finishes, windshield breakage, leakage, fading and deterioration of paints, canvas, vinyl, upholstery and fabrics;
- (b) Gelcoat surfaces including, but not limited to discoloration or blistering except as noted above;
- (c) Accessories and items which were not part of the boat when shipped from the Regal factory, or which carry their own individual warranty and/or any damage caused by such accessories or items;
- (d) Damage caused by one or more of the following: misuse, accident, corrosion, galvanic corrosion, negligence, lack of proper maintenance, or improper towing;
- (e) Any boat used for racing, or used for rental or commercial purposes;
- (f) Any boat operated contrary to any instructions furnished by Regal, including instructions and guidance provided in the Regal Owner's Manual, or operated in violation of any federal, state, Coast Guard or other governmental agency laws, rules, or regulations;
- (g) The limited warranty is void if alterations have been made to the boat;
- (h) Transportation of boat or parts to and/or from the REGAL factory or service location;
- (i) Travel time or haul outs, loss of time or inconvenience;
- (j) Any published or announced catalog performance characteristics of speed, fuel and oil consumption, and static or dynamic transportation in the water;
- (k) Any boat that has been re-powered beyond Regal's power recommendations;
- (l) Boats damaged by accident and boats damaged while being loaded onto, transported upon or unloaded from trailers, cradles, or other devices used to place boats in water, remove boats from water or store or transport boats on or over land;
- (m) Any item repaired, replaced or modified under the terms of this warranty does not in any way prolong, extend or change any terms set forth in this limited warranty;
- (n) Water damage to, dry rot to, condensation to, or absorption by interior surfaces, wood structures or polyurethane foam; interior wood including, but not limited to mold, bleeding and/or discoloration as a result of condensation or moisture or water continually contacting the plywood causing staining to upholstery, carpet or other interior surfaces;
- (o) Costs or charges derived from inconvenience or loss of use, commercial or monetary loss due to time loss, and any other special, incidental or consequential damage of any kind or nature whatsoever;
- (p) Regal reserves the right to improve the design or manufacture process of Regal boats without obligation to modify previously produced product;

**NO WAIVER OF THESE TERMS:** The terms, conditions, limitations and disclaimers contained herein cannot be waived except by the Customer Service Manager of Regal. Any such waiver must be in writing. Neither the dealer, nor the customer, nor any service, sales and/or warranty representative of Regal is authorized to waive and/or modify these conditions, limitations and/or disclaimers.

**EXCEPT AS SET FORTH HEREIN OR ON ANY OTHER WRITTEN EXPRESS LIMITED WARRANTIES BY REGAL, THERE ARE NO OTHER WARRANTIES EITHER EXPRESSED OR IMPLIED PROVIDED BY REGAL ON THIS BOAT. ALL OTHER WARRANTIES, EXPRESS OR IMPLIED, INCLUDING IMPLIED WARRANTIES OF FITNESS AND MERCHANTABILITY, ARE EXPRESSLY EXCLUDED.** REGAL FURTHER DISCLAIMS ANY LIABILITY FOR ECONOMIC LOSS ARISING FROM CLAIMS OF PRODUCT FAILURE, NEGLIGENCE, DEFECTIVE DESIGN, MANUFACTURING DEFECT, FAILURE TO WARN AND/OR INSTRUCT, LACK OF SEAWORTHINESS, AND ANY OTHER THEORY OF LIABILITY NOT EXPRESSLY COVERED UNDER THE TERMS OF THIS LIMITED WARRANTY.

AS SET FORTH ABOVE, REGAL MAKES NO IMPLIED WARRANTY OF MERCHANTABILITY AND EXPRESSLY EXCLUDES ANY SUCH WARRANTY. TO THE EXTENT SUCH EXCLUSION IS NOT ALLOWED BY LAW OR AN IMPLIED WARRANTY OF MERCHANTABILITY IS ALLOWED BY LAW: (1) ANY IMPLIED WARRANTY OF MERCHANTABILITY THAT IS, AS A MATTER OF LAW, NOT PERMITTED TO BE EXCLUDED AS SET FORTH ABOVE, IS LIMITED TO ONE

YEAR FROM THE DATE OF DELIVERY TO THE FIRST RETAIL OWNER; (2) NEITHER REGAL NOR ANY SELLING DEALER SHALL HAVE ANY RESPONSIBILITY FOR LOSS OR USE OF THE BOAT, LOSS OF TIME, INCONVENIENCE, COMMERCIAL LOSS, INCIDENTAL OR CONSEQUENTIAL DAMAGES. SOME STATES MAY NOT ALLOW EXCLUSIONS OF IMPLIED WARRANTIES OR LIMITATIONS ON HOW LONG ANY IMPLIED WARRANTY LASTS, SO THE ABOVE LIMITATION MAY NOT BE APPLICABLE. SOME STATES MAY NOT ALLOW THE EXCLUSION OR LIMITATION OF INCIDENTAL OR CONSEQUENTIAL DAMAGES, SO THE ABOVE LIMITATIONS OR EXCLUSIONS MAY NOT BE APPLICABLE IN THOSE STATES. THIS WARRANTY GIVES THE OWNER SPECIFIC LEGAL RIGHTS, AND THE OWNER MAY ALSO HAVE OTHER RIGHTS WHICH VARY FROM STATE TO STATE.

THE TERMS AND CONDITIONS CONTAINED HEREIN, AS WELL AS THOSE OF ANY DOCUMENTS PREPARED IN CONJUNCTION WITH THE SALE OF THIS VESSEL MAY NOT BE MODIFIED, ALTERED OR WAIVED BY ANY ACTION, INACTION OR REPRESENTATIONS, WHETHER ORAL OR IN WRITING, EXCEPT UPON THE EXPRESSED, WRITTEN AUTHORITY OF A MANAGEMENT LEVEL EMPLOYEE OF REGAL. Some states do not allow limitations on how long an implied warranty lasts, so the above limitation may not apply to you. Regal's obligation with respect to this warranty is limited to making repairs to or replacing the defective parts and no claim for breach of warranty shall be cause for cancellation or rescission of the contract or sale for any boat manufacturer by REGAL MARINE INDUSTRIES, INC.

Regal will discharge its obligations under this warranty as rapidly as possible, but cannot guarantee any specific completion date due to the different nature of claims which may be made and services which may be required. Regal reserves the right to change or improve the design of its boats without obligation to modify any boat previously manufactured. This limited warranty gives you specific legal rights, and you may also have other rights which may vary from state to state. Regal shall in no way be responsible for any repairs not PRE-AUTHORIZED by a Regal Customer Service Manager or repairs performed by a repair shop not PRE-AUTHORIZED by a Regal Customer Service Manager.

## **ARBITRATION OF DISPUTES AND WAIVER OF JURY TRIAL**

EXCEPT AS SPECIFICALLY EXCLUDED IN THIS LIMITED WARRANTY, PURCHASER, REGAL AND AUTHORIZED REGAL DEALER AGREE TO SUBMIT ANY AND ALL CONTROVERSIES, CLAIMS OR DISPUTES ARISING OUT OF OR RELATING TO THE BOAT AND THIS LIMITED WARRANTY AND ALL OTHER AGREEMENTS EXECUTED BY PURCHASER RELATED TO THE BOAT TO BINDING ARBITRATION. IT IS THE EXPRESS INTENT OF PURCHASER, REGAL AND DEALER THAT THIS ARBITRATION PROVISION APPLIES TO ALL DISPUTES, INCLUDING CONTRACT DISPUTES, TORT CLAIMS, FRAUD CLAIMS AND FRAUD-IN-THE INDUCEMENT CLAIMS, STATUTORY CLAIMS AND REGULATORY CLAIMS RELATING IN ANY MANNER TO THE BOAT AND THIS LIMITED WARRANTY.

IF ANY CONTROVERSY OR CLAIM DESCRIBED IN THIS ARBITRATION PROVISION IS DETERMINED FOR ANY REASON TO BE INELIGIBLE FOR ARBITRATION, AND FOR ANY CONTROVERSIES, CLAIMS, OR DISPUTES SPECIFICALLY EXEMPTED FROM ARBITRATION, THEN THOSE CONTROVERSIES, CLAIMS, OR DISPUTES SHALL INSTEAD BE DECIDED BY A JUDGE OF A COURT OF COMPETENT JURISDICTION, IN ORANGE COUNTY, FLORIDA, WITHOUT A JURY. PURCHASER, REGAL AND DEALER KNOWINGLY AND VOLUNTARILY WAIVE THE RIGHT TO A TRIAL BY JURY FOR ALL SUCH CONTROVERSIES, CLAIMS AND DISPUTES. PURCHASER, REGAL, AND DEALER UNDERSTAND THAT THERE SHALL BE NO JURY TRIAL, WHETHER THE CONTROVERSY OR CLAIM IS DECIDED BY ARBITRATION OR BY TRIAL BEFORE A JUDGE. NOTWITHSTANDING THE PROVISIONS OF THIS ARBITRATION AGREEMENT, WITH REGARD TO CONTROVERSIES AND/OR ENTITLEMENT TO POSSESSION OF EITHER THE BOAT OR ANY TRADE-IN, ANY PARTY HERETO MAY RESORT TO A JUDICIAL DETERMINATION (BY A JUDGE AND NOT A JURY). OF SUCH CONTROVERSIES, DISPUTES OR CLAIMS WITHOUT WAIVING ANY RIGHT TO DEMAND ARBITRATION WITH RESPECT TO ALL OTHER CONTROVERSIES, DISPUTES OR CLAIMS BETWEEN THE PARTIES A MORE SPECIFICALLY SET FORTH IN THIS ARBITRATION PROVISION.

ALL ARBITRATIONS SHALL PROCEED THROUGH THE AMERICAN ARBITRATION ASSOCIATION AND BE SUBJECT TO ITS COMMERCIAL ARBITRATION RULES, EXCEPT AS SET FORTH HEREIN. THE ARBITRATORS SHALL HAVE THE AUTHORITY TO AWARD ANY FORM OF RELIEF THAT COULD BE PROPERLY AWARDED IN A CIVIL ACTION IN THE STATE OF FLORIDA FOR THE TYPE OF CLAIMS PRESENTED, SUBJECT HOWEVER, TO ALL LIMITATIONS, PREDICATES, AND CONDITIONS COVERING SUCH REMEDIES OR RELIEF UNDER FLORIDA LAW.

THE PURCHASER, REGAL OR DEALER MAY DEMAND ARBITRATION OF A CLAIM BY FILING A WRITTEN DEMAND FOR ARBITRATION, ALONG WITH A STATEMENT OF THE MATTER IN CONTROVERSY WITH THE AMERICAN ARBITRATION ASSOCIATION, AND SIMULTANEOUSLY SERVING A COPY UPON THE OTHER PARTY. PURCHASER, REGAL AND DEALER AGREE THAT THE ARBITRATION PROCEEDING SHALL BE CONDUCTED IN ORANGE COUNTY, FLORIDA UNLESS OTHERWISE AGREED BY THE PARTIES. EACH PARTY AGREES TO BEAR THEIR OWN ATTORNEY FEES AND COSTS. THE FILING FEES AND ALL OTHER THIRD-PARTY COSTS FOR THE ARBITRATION, INCLUDING THE ARBITRATOR'S FEE SHALL BE PAID BY THE FILING PARTY INITIATING THE ARBITRATION. THE PREVAILING PARTY SHALL BE ENTITLED TO REIMBURSEMENT OF THEIR REASONABLE ATTORNEY FEES AND REASONABLE EXPENSES FROM THE NON-PREVAILING PARTY.

## **REGISTRATION INFORMATION:**

# Chapter 2

## Safety On Board

Safety awareness can not be over emphasized. Safety on board needs to be the skippers number one priority. In this manual you will find many safety precautions and symbols to identify safety related items. Heed all safety precaution information. Remember, the skipper is responsible for the safety of his passengers and crew.

### Safety Labels

#### Safety Precaution Definition:

Safety precautions are stated as caution, warning and danger signal words. They are highlighted in this manual by font design and symbol usage. Also, a notice heading is included which provides operation and maintenance information but is not hazard-related. An information label provides tips on a variety of topics. Become familiar and understand all safety precaution labels!

	<b>WARNING</b>
Potentially hazardous situation that, if not avoided, could result in death or serious injury.	

	<b>DANGER</b>
Immediate hazardous situation that if not avoided, will result in death or serious injury.	

<b>NOTICE</b>
General or specific information which is important to correct operation or maintenance, but is not hazard related.

	<b>CAUTION</b>
Indicates a potentially hazardous situation or unsafe practice that, if not avoided, may result in injury, property or product damage.	

## Precautionary Labels

Read and understand all safety labels affixed to your Regal boat or found in this manual and the vendor literature. Many of the safety labels are posted close to the helm, aft cockpit, cabin and swim platform. The location of the labels may vary. Review the helm safety labels with passengers before disembarking. Use common sense to analyze the result of an action on board your vessel. Always think safety first!

# NOTICE

DO NOT REMOVE OR COVER ANY PRECAUTIONARY LABELS. KEEP HARSH CHEMICALS AWAY FROM LABELS. IF A LABEL BECOMES ILLEGIBLE, CONTACT YOUR REGAL DEALER FOR ORDERING REPLACEMENTS.

## General Boating Safety

We understand that you are eager to go boating. However, we strongly suggest that you thoroughly familiarize yourself and friends or members of your family with safe boating practices before setting out. Remember, that along with the freedom and exhilaration of boating comes the responsibility that you have for the safety of your passengers and other boaters who share the water with you.

Boating regulations vary from state to state. Check with your local and state authorities for the regulations pertaining to your area.

Check with local FM weather stations, U. S. Coast Guard, or on-line for the latest weather conditions.

Remember getting caught in severe weather is hazardous. Check weather conditions periodically while you are boating. If you are forced to operate your boat in a storm condition, take common sense precautions; wear PFD's, store gear, reduce speed and if possible head for safe refuge.

It is best to avoid operating your boat in foggy weather. When fog sets in, take bearings, log courses and speeds. You are required to emit a five second blast from your horn or whistle once every minute. Also, have your passengers wear PFD's and observe for oncoming vessels.

Operation in shallow water presents a number of hazards including sand bars and water levels influenced by tides. If the vessel strikes an underwater hazard, check for boat and engine damage. If the engine vibrates excessively after striking an underwater obstruction, it may indicate a damaged propeller. If you run aground, seek help by radio or flares.

Make sure your boat and equipment are in top condition. Do this by frequently inspecting the hull, engine and propulsion components.

You must provide a Coast Guard approved personal flotation device (PFD) for every person on board. These PFD's must be in excellent condition and easily accessible.

Insist that non-swimmers and children on board wear a PFD at all times. If you encounter rough weather conditions, make sure everyone on board is wearing a PFD, including yourself.

Instruct your passengers in how to put on their PFDs and be sure they know their storage location

on the boat. Remember, in an emergency, a PFD that cannot be quickly located and worn is useless.

Never allow anyone to sit anywhere on the boat not specifically designed as seating. **While underway, ALWAYS insist passengers occupy a recognized seat position. See technical chapter.**

Never drink and drive! As captain, you are responsible for the safety of your passengers. Alcohol and



boating can be a dangerous combination. **DO NOT** mix them. Alcohol impairs the boat operators ability to make conscious decisions

and react to emergency situations quickly.

Never overload your boat! An overloaded boat, or one with uneven weight distribution can be difficult to steer. **Never let people stand in bow area while underway as vision will be obstructed!!!**

 **CAUTION**

READ AND UNDERSTAND THE SEATING  
ARRANGEMENT DRAWING IN THE  
TECHNICAL CHAPTER.  
THIS DRAWING DISPLAYS THE  
DESIGNATED SEATING  
ARRANGEMENT FOR A BALANCED  
LOAD AND VESSEL MAXIMUM PERSONS  
CAPACITY.

Use maximum caution when fueling. Never allow any smoke or flame nearby while you are fueling. **ALWAYS** check for fuel leaks and fumes when

fueling is completed. Be certain there is enough fuel aboard for your cruising needs. Include any reserve that might be needed should you change your plans due to weather or an emergency. Practice the “one-third rule: Use one-third of your fuel going out, one-third to return and retain one-third as a reserve.

Always check the weather before departure. Be particularly cautious of forecasted electrical storms and high winds.

Always have up-to-date charts aboard as a backup to your plotter and auto pilot option. Charts can be obtained at a marina, on-line store or by contacting one of three federal government agencies.

Always file a float plan. Leave details of your trip with someone responsible who will be remaining on shore. Include expected return, plus name and phone number of a contact person in case of emergency.

Use care, courtesy and common sense when launching, docking or operating your boat.

Learn and obey the “Rules of the Road”. A weather resistant placard copy of the “Rules of the Road” is included in the on board Regal information packet. Additional information can be obtained from the U.S. Coast Guard Auxiliary or your local Power Squadron organization.

In case of emergency know the international distress signals for your VHF radio. The spoken word “MAYDAY” is the international signal of distress and is for emergency use only. Under no circumstances should this word be used, unless there is danger at hand.



## General Boating Safety - Continued

Operation in shallow water presents a number of hazards including sand bars and water levels influenced by tides. If the vessel strikes an underwater hazard, check for boat and engine damage. If the engine vibrates excessively after striking an underwater obstruction, it may indicate a damaged propeller. If you run aground, seek help by radio or flares.

Make sure your boat and equipment are in top condition. Do this by frequently inspecting the hull, engine and propulsion components.

You must provide a Coast Guard approved personal flotation device (PFD) for every person on board. These PFD's should be in good condition and easily accessible.

Insist that non-swimmers and children on board wear a PFD at all times. If you encounter rough weather conditions, make sure everyone on board is wearing a PFD, including yourself. Instruct your passengers in how to put on their PFDs and be sure they know their storage location on the boat. Remember, in an emergency, a PFD that cannot be quickly located and worn is useless.

Never allow anyone to sit anywhere on the boat not specifically designed as seating. While underway, **ALWAYS** insist passengers sit in a seat and set an example by doing this yourself.

Never drink and drive! As captain, you are responsible for the safety of your passengers. Alcohol and boating can be a dangerous combination. **DO NOT** mix them. Alcohol impairs the boat operators ability to make conscious decisions and react to emergency situations quickly.

Never overload your boat! An overloaded boat, or one with uneven weight distribution can be difficult to steer.

**Insist that passengers sit in seats while the vessel is making headway!! No one shall be standing in the bow area while underway as visibility will be obstructed!!!**

Posted speed limits, swimming areas, "no wake" zones and other restrictions should be red-flagged. They are so noted for a reason. Sensible boat use, plus courtesy, equals enjoyable and safe boating.

It is your responsibility to stay abreast of all federal, state and local rules, as some laws or regulations may change or be different from state to state. Contact your local boating agencies for updated information.

We can not stress safety enough! Remember, there are no brakes on your boat, and the water current and wind velocity both affect your ability to respond.

## Required Safety Equipment

### Personal Flotation Devices:

All personal flotation devices (PFD's) must be Coast Guard approved, in good working condition, and must be the correct size for the wearer. All PFD's must be readily accessible. This means being able to wear them in a reasonable amount of time in case of an emergency (fire, boat sinking, etc.). They should not be stored or locked in closed areas. Also, make sure that all coverings are removed such as plastic from any PFD's. Throw-able devices such as a ring buoy need to be available for immediate deployment. A PFD should be worn at all times when your boat is operating on the water. A PFD may save your life, but it must be worn to do so.

As a minimum U. S. Coast Guard requirement all recreational boats must carry one type I, II, III, or V PFD (wearable) for each person aboard. See the explanation following for each type. For type V to be counted they must be used according to the label instructions. In addition, all boats over 16' must carry one Type IV (throw-able) PFD.

Some states require that PFD's be worn by children of specific ages at all times. Check with local and state boating agencies for particular requirements in your state before taking children on the water. Child life jackets are classified by the child's weight and should like all life jackets be sized before being purchased.

Remember PFD's will not necessarily keep you from drowning, even though they are designed to keep a person from sinking. When purchasing PFD's make sure it safely fits the person wearing it. It is a good idea to test PFD's in a life guarded

shallow pool before venturing on the water.

Refer to the USCG minimum equipment requirements at the end of this chapter. It is meant to be a guide only. Contact state and local agencies for additional equipment requirements. Remember as the captain of your vessel you are responsible for its safe operation.



### Type I:

Also known as an off-shore jacket, it provides the most buoyancy. It is a PFD for all waters and is especially useful in rough waters where rescue may encompass additional time. It is designed to turn most unconscious users in the water to a true face-up position. Type I PFD is available in adult & child sizes Buoyancy minimum poundages are 15.5 adult, 11 medium child, and 7 for small child and infants.

### Type II:

Also known as near-shore buoyant vest, it is recommended for calm, inland water where rescue time will be minimal. It will turn some unconscious people face-up in the water but not as numerous as Type I. They are available in adult, medium child, along with infant and small child sizes.

### Type III:

Known as a flotation aid it is good for calm, inland water or where there is a chance for quick rescue. It is designed so wearers can place themselves in a face-up position in the water. The wearer may have to tilt their head back to avoid face-down positions. Type III offer the same buoyancy minimum poundages as the Type II. They are generally the most comfortable for continuous wear. Float coats, fishing vests, and vests featuring designs for various sport activities are examples of Type III.

### Type IV:

Intended for calm, inland water with heavy vessel traffic, where help is constantly present. It is designed to be thrown into the water for someone to grab on to and held until rescued. It is not designed to be worn. Type IV includes ring buoys, buoyant cushions, and horseshoe buoys.

### Type V:

Also known as a special use device this is the least bulky of all PFD's. It contains a small amount of inherent buoyancy, and an inflatable chamber. It is rated even to a Type I, II, or III PFD (as noted on the jacket label) when inflated. Some Type V devices provide significant hypothermia protection. Varieties include deck suits, work vests, board sailing vests and Hybrid PFD's. Remember that this Type V type PFD may be carried instead of another PFD only if used according to the approval condition on the label.

Note: A water skier or wake boarder is considered on board the vessel and a PFD is required for the purposes of compliance with the PFD carriage requirements. It is advisable and recommended for a skier or wake boarder to wear a PFD designed to withstand the impact of hitting the water at a high speed. "Impact Class" marking on the label refers to PFD strength, not personal protection. Some state laws require a skier or wake boarder to wear a PFD.

## PFD's For Pets:

If you are a skipper who needs to have his pet dog or cat on board or dock side then a PFD is recommended. The PFD will aid you in finding the pet if it should fall overboard. The device must fit the pet properly. Also, it may take a bit of training before the pet is comfortable wearing the PFD. Normally, dogs are easier to train wearing a life vest than a cat. Marine type retail stores will fit a pet to a PFD by body weight.

## Maintaining Your PFD's

A PFD is only useful if it is well maintained. Always be aware of PFD age since it has a life expectancy like any other piece of equipment.

- ✓ Check periodically for broken zippers, frayed webbing, water soaked kapok bags, missing straps, and sewing that has become undone.
- ✓ Clean each PFD with mild soap and water only. Again, let dry sufficiently before storing.
- ✓ Keep PFD's out of grease and oil since they can deteriorate the jacket inner and outer materials.
- ✓ Check any kapok-bagged jackets by squeezing. If you hear air escaping the bag is defective and the PFD should be thrown away.
- ✓ Grab the cover with the fingers. If the cover material rips, the PFD is rotted and should be thrown away.
- ✓ If the kapok bag is hard the PFD should be discarded.

## Fire Extinguishers

### General Information:

Fire extinguishers are classified by a letter and numeric symbol. The letter references the type of fire the unit is designed to extinguish.

For example, type B extinguishers commonly used on boats are designed to put out flammable liquids such as grease, oil and gasoline.

The number indicates the general size of the extinguisher (minimum extinguishing agent weight). Coast Guard Approved extinguishers are identified by the following marking on the label:

*"Marine Type USCG Approved, Size..., Type..., 162.028/.../", etc.*

MINIMUM PORTABLE FIRE EXTINGUISHERS REQUIRED		
VESSEL LENGTH	NO FIXED SYSTEM	WITH FIXED SYSTEM
LESS THAN 26'	1 B-I	0
26' TO LESS THAN 40'	2 B-I or 1 B-II	1 B-I
40' TO 65'	3 B-I or 1 B-I & 1 B-II	2 B-I or 1 B-II

FIRE EXTINGUISHER CONTENTS				
CLASS	FOAM IN GALS.	CO2 IN LBS.	DRY CHEM IN LBS.	HALON IN LBS.
B-I	1.25	4	2	2.5
B-II	2.5	15	10	10

U. S. Coast Guard approved fire extinguishers are required on domestic watercraft. Besides the minimum Coast Guard requirements always check state and local agencies for additional requirements and equipment.

Coast Guard approved extinguishers are hand-portable, either B-I or B-II classification. U. S. Coast Guard approved hand-portable and semi-portable extinguishers contain a metal plate that shows the manufacturers name and extinguisher type, capacity and operating instructions. They have a special marine type mounting bracket which keeps the extinguisher solidly mounted until needed. The extinguisher needs to be mounted in a readily accessible location but one that will not be bumped by people while underway. All approved extinguishers shall have an indication gauge.

### U.S.C.G Approved Fire Extinguisher Types

#### & Features:

The dry chemical agent is widely used because of



its convenience and low cost. The extinguisher canister is filled with a white dry chemical powder along with a pressurized gas. It is a good idea

to shake this type periodically because they tend to “pack” on the canister bottom.

The foam type uses a chemical foaming agent plus water and is best when used for fires involving flammable liquids-



solvents, gasoline, oil, grease and various paints. It will work on fires involving rubber, plastics, cloth, wood, and paper. It leaves a

messy residue. Do not use this extinguisher for electric fires.



The carbon dioxide unit uses CO<sub>2</sub> gas under high pressure, with a funnel discharge hose usually swivel mounted. This extinguisher leaves no residue

and does not cause interior engine harm. To ensure workability, weigh the unit annually. A 10% maximum weight variance is allowed.

Another type of liquefied gas used today is FE-241. This gas is colorless and odorless, heavier than air and sinks to the lower bilge to extinguish fires. Since the year 2000 ingredients have changed to a more environmental friendly formula (Chlorotetrafluoroethane or FE-241). FE-241 is used in portable-hand units along with making up the majority of boat automatic fire extinguishing systems. The canister needs to be weighed once a year. These clean agent units feature a dash mount indicator. Refer to the information regarding fire prevention in this manual.

## **Pyrotechnic Devices:**

Pyrotechnic visual distress signals must be Coast Guard approved, be ready for service and must be readily accessible. They all display a marking which is the service life, which must not have expired. A minimum of 3 devices are required for the day and 3 devices for night.

Some devices meet both day and night requirements. Pyrotechnic devices should be stored in a cool, dry location. Most of these devices can be purchased in an highly visible (orange) watertight container. Types of Coast Guard approved pyrotechnic distress signals and associated devices are:

- Pyrotechnic red flares, hand-held or aerial type.
- Pyrotechnic orange smoke, hand-held or floating type.
- Launchers for parachute flares or aerial red meteors.

All in all, each distress signal has certain advantages and disadvantages.

There is no distress signal that is best under all situations. Pyrotechnics are recognized worldwide as superior distress signals. A downfall is they emit a very hot flame that can cause burns and or ignite flammable materials. Pistol launched and hand-held parachute flares operate consistent with firearms and therefore must be carefully handled. Check with local and state regulations since some of these device are considered firearms and are prohibited.

It is best to carry red aerial flares which are visible

from a greater distance. Also, the red parachute flares burn for longer periods and therefore are more likely to be seen by another vessel.

## **Non-Pyrotechnic Devices:**

Non-pyrotechnic devices must all be in serviceable condition, readily accessible, and must be certified by the manufacturer to comply with USCG standards. They include:

- Orange distress flag.
- Electric distress light.

The distress flag is for day use only. It must be 3 x 3 or larger with a black square and ball on an orange background. It can be spotted when attached to a boat hook, long fishing rod, or paddle with the person waving the flag back and forth overhead.

The electric distress light is for night use only flashing the international SOS distress signal (... \_ \_ \_ ...).

Under Inland Navigation Rules, a high intensity white light that flashes at regular intervals from 50-70 times per minute is considered a distress signal.

Remember that regulations prohibit the display of visual distress signals on the water under any circumstances except when assistance is required to prevent immediate or potential danger to passengers on a vessel.

# International Distress Signals



BLACK SQUARE  
AND BALL ON  
ORANGE BACKGROUND



CODE FLAGS  
NOVEMBER  
& CHARLIE



SQUARE FLAG  
& BALL



PERSON  
WAVING  
HANDS

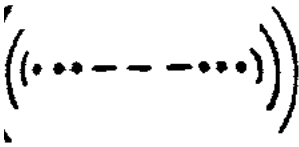

MORSE  
CODE S.O.S.



"MAYDAY"  
BY  
RADIO

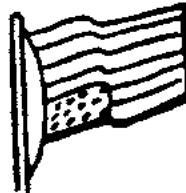

ENSIGN  
UPSIDE  
DOWN



PARACHUTE  
RED FLARE



RED METEOR  
FLARES



SMOKE



FOG HORN  
SOUNDED  
CONTINUOUSLY

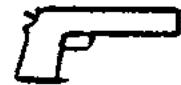

GUN FIRED AT  
1- MINUTE  
INTERVALS

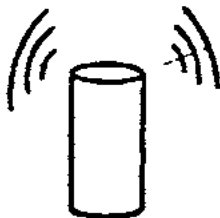

POSITION  
INDICATING  
RADIO BEACON



DYE MARKER  
(ANY COLOR)

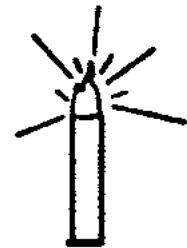

HAND-HELD  
FLARE



## Sound Producing Devices

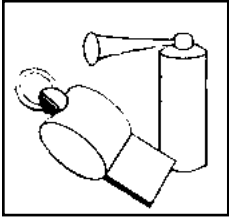

According to both Inland and International Rules, all boats must carry a way of producing an efficient sound signal. If your vessel is 12 meters (39' 4") or longer, a power whistle or power horn and bell must be carried. Bell mouth must be at least 7 7/8" diameter. The sound signal made in all cases must be capable of a four or six second blast audible for one half mile. See the section discussing bridge and whistle signals for more information.

## Radio Communications:

VHF radios are used for distress and ship to shore and ship to ship communications today. Learn the specialized messages such as Mayday, Mayday, Mayday. It is only used when life or vessel is in imminent danger.



Many of the more recent VHF's feature DSC capability which offers the ability to place and receive digital calls directly with vessels and shore stations including USA and Canadian Coast Guards. Channel 70 is reserved exclusively for DSC calls. Refer to the VHF owner's information since you need to establish a Mobile Maritime Safety Identity (MMSI) number before using the DSC feature. A MMSI number identifies each DSC radio, like a telephone number. The FCC requires a ship station license for all vessels equipped with a marine VHF radio.

## Navigation Lights:

The U. S. Coast Guard requires recreational boats operating at night to display navigation lights between sunset and sunrise along with other periods of reduced visibility.

Navigation lights help avoid collisions by improving the night visibility of vessels. Red and green directional lights, white stern lights, white masthead lights and white all-around lights must be displayed in specified positions, depending on boat size, and mode of operation.

## Marine Sanitation Devices:

Recreational vessels under 65' with installed toilet facilities must have an operable marine sanitation device (MSD) on board. Vessels 65' and under may use Type I, II, or III MSD's. All installed MSD's must be U.S. Coast Guard certified. The MSD's are labeled to show conformity to the regulations.

## Navigation Rules:

The navigation rules establish actions to be taken by vessels to avoid collision. They are divided into Inland/International. Operators of vessels 39.4' or more shall have on board and maintain a copy of the Inland navigation rules.



# Navigation Light Rules

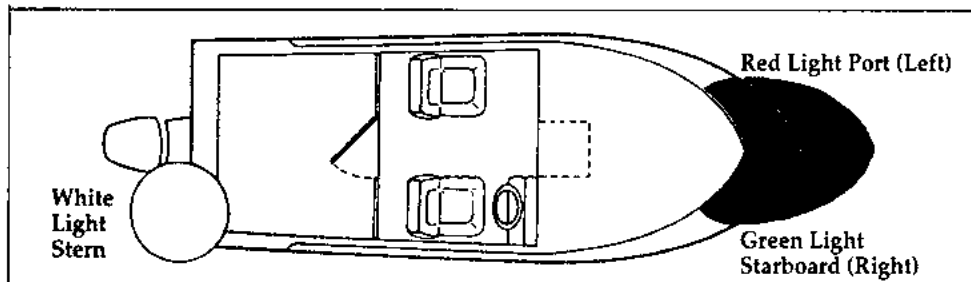

Location of lights on vessel	Visible Range		Degrees of arc lights
	Less than 12 m.	12 m. but less than 20 m.	
Masthead	2	3	225°
All-round	2	2	360°
Side lights	1	2	112.5° each color
Stern light	2	2	135°

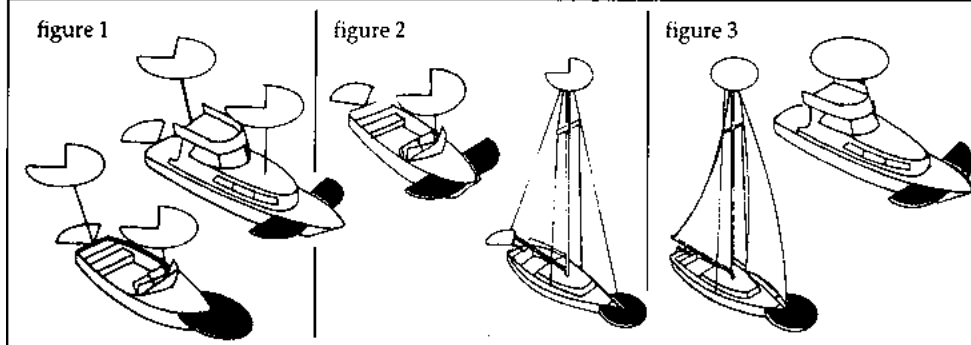

**Boats less than 12 meters in length**  
*Motorboats or sailboats using power:* The lighting arrangements to figure 1, 2 or 3 may be used.  
*Sailboat using sails alone:* The lighting arrangements in figure 4, 5 or 6 may be used.

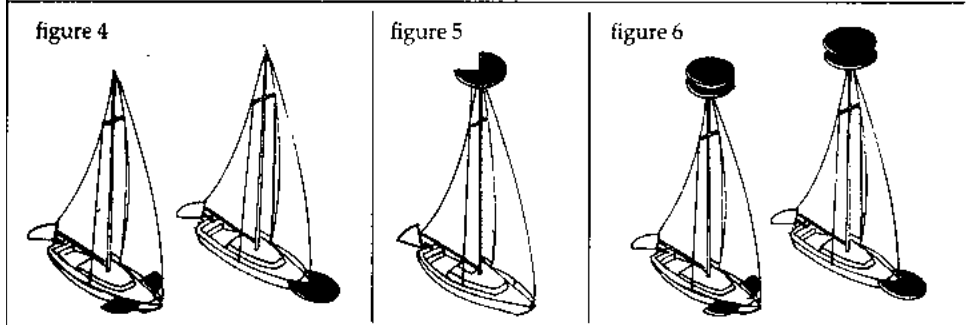

**Boats 12 meters but less than 20 meters in length**  
*Motorboats or sailboats using power:* The lighting arrangements to figure 1 or 2 may be used.  
*Sailboat using sails alone:* The lighting arrangements in figure 4, 5 or 6 may be used.

**Location of lights**  
 Lights should be located as shown in the drawings.  
 The masthead light (forward white light in figures 1, 2 and 7d) must be at least one meter higher than the colored lights on a boat less than 12 meters in length and at least 2.5 meters above the gunwale on a boat 12 meters but less than 20 meters in length.

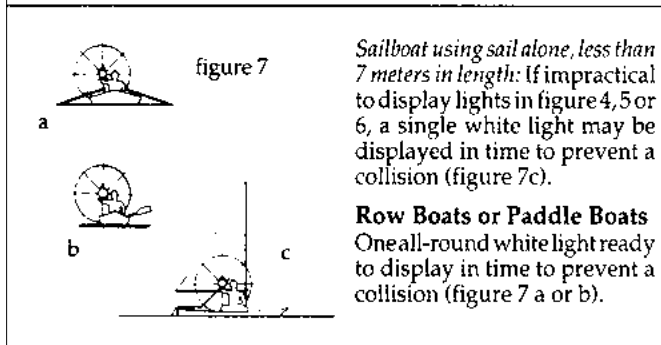

**Sailboat using sail alone, less than 7 meters in length:** If impractical to display lights in figure 4, 5 or 6, a single white light may be displayed in time to prevent a collision (figure 7c).

**Row Boats or Paddle Boats**  
 One all-round white light ready to display in time to prevent a collision (figure 7 a or b).

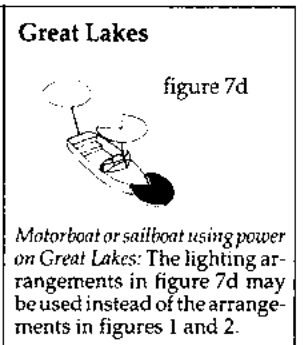

**Great Lakes**  
*Motorboat or sailboat using power on Great Lakes:* The lighting arrangements in figure 7d may be used instead of the arrangements in figures 1 and 2.

**Exceptions**  
*Motorboat or sailboat using power, built before December 24, 1980:* The lighting arrangement in figure 1, 2 or 3 may be used. However, the arrangement in figure 3 is not acceptable on a boat that is 12 meters or longer on international waters.

### DISCHARGE OF OIL PROHIBITED

THE FEDERAL WATER POLLUTION CONTROL ACT PROHIBITS THE DISCHARGE OF OIL OR OILY WASTE INTO OR UPON THE NAVIGABLE WATERS OF THE UNITED STATES, OR THE WATERS OF THE CONTIGUOUS ZONE, OR WHICH MAY AFFECT NATURAL RESOURCES BELONGING TO, APPERTAINING TO, OR UNDER THE EXCLUSIVE MANAGEMENT AUTHORITY OF THE UNITED STATES, IF SUCH DISCHARGE CAUSES A FILM OR DISCOLORATION OF THE SURFACE OF THE WATER OR CAUSES A SLUDGE OR EMULSION BENEATH THE SURFACE OF THE WATER. VIOLATORS ARE SUBJECT TO SUBSTANTIAL CIVIL PENALTIES AND/OR CRIMINAL SANCTIONS INCLUDING FINES AND IMPRISONMENT.

#### **Marpol Treaty:**

The USCG now enforces the International Convention for the Prevention of Pollution from ships, referred to commonly as the MARPOL TREATY (marine pollution). This international treaty prohibits the overboard dumping of all oil, garbage, ship-generated plastic and chemicals. There is a placard on board your boat (typical example shown below) that explains the garbage and plastic dumping laws in detail.

Immediately notify the USCG if your vessel discharges oil or hazardous substances in the water. Call toll free 1-800-424-8802. Report the following information: location, source, size, color, substances and time observed.

No vessel may intentionally drain oil or oily waste from any source into the bilge of any vessel. A bucket or bailer is suitable as a portable means of discharging oily waste.

The placard noted above is normally located in the engine compartment or may be attached to the engine hatch.

## Garbage Discharge

THE DISCHARGE OF PLASTIC OR GARBAGE WITH PLASTIC INTO ANY WATERS IS PROHIBITED. THE DISCHARGE OF ALL GARBAGE IS PROHIBITED IN THE NAVIGABLE WATERS OF THE UNITED STATES AND IN ALL OTHER WATERS, WITHIN THREE NAUTICAL MILES OF THE NEAREST LAND.		
THE DISCHARGE OF DUNNAGE, LINING, AND PACKING MATERIALS THAT FLOAT IS PROHIBITED WITHIN 25 NAUTICAL MILES FROM THE NEAREST LAND.	OTHER UNGROUND GARBAGE MAY BE DISCHARGED BEYOND 12 NAUTICAL MILES FROM THE NEAREST LAND.	OTHER GARBAGE GREATER THAN ONE INCH MAY BE DISCHARGED BEYOND THREE NAUTICAL MILES FROM THE NEAREST LAND.
A PERSON WHO VIOLATES THE ABOVE REQUIREMENTS IS LIABLE FOR A CIVIL PENALTY OF UP TO \$25,000, A FINE OF UP TO \$50,000, AND IMPRISONMENT FOR UP TO FIVE YEARS FOR EACH VIOLATION, REGIONAL, STATE, AND LOCAL RESTRICTIONS ON GARBAGE DISCHARGES MAY ALSO APPLY.		

The act to prevent pollution from ships places limitations on the discharge of garbage from vessels. It is illegal to dump plastic trash anywhere in the ocean or navigable waters of the United States. Also, it is illegal to discharge garbage in the navigable waters of the United States, including the Great Lakes. The two statements above includes all vessels. The discharge of other types of garbage is allowed outside certain specified distances from shore as determined by the nature of that garbage.

United States vessels of 26 feet or longer must display in a prominent location, a durable placard at least 4" x 9" notifying crew and passengers of discharge restrictions.

USA vessels of 26' or longer equipped with a galley and berthing must have a written Management Plan describing the plan for collecting, processing, storing and discharging garbage, and designate the person charged with carrying out the plan.

The placard noted below is usually found near a galley, inside the engine hatch area or close to a receptacle.



## USCG MIN. EQUIPMENT REQUIREMENTS

Use the chart below as a guideline for assuring your vessel is outfitted to meet USCG standards. Remember to check with local and state authorities for additional equipment requirements. Make sure your vessel certificate of numbers are on the boat, updated and displayed properly according to state requirements. Keep the paperwork on board in a watertight and safe environment. On documented vessels keep both the original and current certificate on board stored in a safe, dry, and accessible location. Also, on documented vessels make sure the vessel name/hailing port are marked on the hull exterior with letters not less than 4" in height. In addition, the Official Number must be permanently affixed on a clearly visible interior structure part of the boat-block type Arabic numbers not less than 3" in height.

## Life Rafts

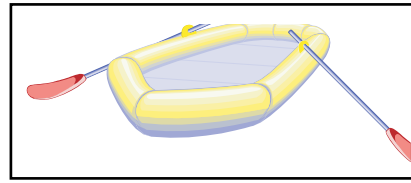

Inflatable life rafts are recommended for ocean going and vessels

operating in a large body of water like the Great Lakes. They provide a shelter for extended periods. If used, make sure it is large enough for all aboard and contains the proper emergency equipment pack. Also, periodically have the unit professionally serviced. Make sure the life raft is Coast Guard approved since it would require meeting a number of stringent material and performance standards.

USCG Minimum Equipment Requirements for Recreational Vessels					
Boat Size in Feet	16'	26'	40'	65'	165'
<b>Personal Flotation Devices<sup>1</sup></b>	One Type I, II, III, or V per person		One Type I, II, III, or V per person plus one Type IV throwable		
<b>Fire Extinguishers<sup>2</sup></b>					One or more B-II (vessels 0-50 tons gross) Two or more B-II (vessels 50-100 tons gross)
No Fixed System	One B-I, any type		One B-II or Two B-I	One B-II and one B-I, or three B-I	
With Fixed System	No Portables Required		One B-I	Two B-I or one Class B-II	
<b>Visual Distress Signals</b>	Night signals required when operating at night		Minimum of three day-use and three night-use (or three day/night combination) pyrotechnic devices <sup>5</sup>		
<b>Sound Producing Devices</b>	Horn or whistle recommended to signal intentions or signal position		One bell, and one whistle or horn required to signal intentions or position		
<b>Backfire Flame Arrestor</b>	One CG-approved device on each carburetor of all gasoline-powered engines built after April 1940, except outboard motors				
<b>Ventilation</b>	CG standard system required on gasoline powered vessels with enclosed engine compartments built after August 1980				
<b>Navigation Lights</b>					
Under Power <sup>3,4</sup>	Sidelights, Stern Light and Masthead <sup>6,7</sup>				
Under Sail	Sidelights and Stern Light <sup>8,B</sup>				
Rowing	Same as "Under Sail"				
At Anchor	All-round light, 2nm (at night) or black anchoring ball (during the day) when outside a designated anchorage				
Visibility Range	1nm Sidelights, 2nm all others		3nm Masthead, 2nm all others		5nm Masthead, 2nm all others
<b>Pollution Regulations</b>	"Honor system" (no plaques required)		5" x 8" Oil Discharge placard and 4" x 9" Waste Discharge placard Vessels over 40' with a galley must have a Waste Management Plan		
<b>Marine Sanitation Devices</b>	Vessels with installed toilet facilities must have an operable, CG-certified Type I, II or III Marine Sanitation Device (MSD). <b>Subject to local laws!</b>				Type II or III MSD only
<b>Navigation Rules</b>	Familiarity with the Inland Navigation Rules required			The Inland Navigation Rules ("Rules of the Road") must be kept on board	

<ol style="list-style-type: none"> <li>1. PFD's must be CG approved, wearable by the intended user and readily accessible.</li> <li>2. Fire extinguishers required on boats with enclosed engine compartments (not outboards), enclosed living spaces or permanent fuel tanks.</li> <li>3. Sailboats operating under engine power are considered power driven and must follow the "Under Power" rules. During the day, motorsailing vessels are required to fly a motoring cone.</li> <li>4. Power-driven vessels under 25' and under 7 knots can substitute a white lantern or torch in place of the required lights.</li> </ol>	<ol style="list-style-type: none"> <li>5. Non-pyrotechnic substitutes: 1 orange distress flag (day-use) and 1 electric SOS signal light (night-use).</li> <li>6. All boats under 65' can substitute a single bi-color light for sidelights.</li> <li>7. Boats under power under 40' can substitute a single all-round light for separate stern and masthead lights.</li> <li>8. Boats under sail under 40' can substitute a tri-color light for separate sidelights and stern light.</li> </ol>
---	---

**Additions to these requirements are prescribed by some individual state laws. Check your state's Boating Safety Handbook for a complete list.**

## Exhaust & Carbon Monoxide

Carbon monoxide (CO) in exhaust can be hazardous, especially from gasoline engines, gasoline generators, grills, stoves, space heaters and on a much smaller degree diesel engines.

CO is a natural by-product of the gasoline engine using an artificial spark. Diesels on the other hand detonate fuel using pressure and temperature. Looking at the two engines another way, gasoline engines use much more oxygen up in the combustion process which contributes to a much higher CO build-up. Although diesels do produce a small amount of CO the combustion process operates with much greater amounts of oxygen which the end result is a much lower CO level.

Ensure that you read the information and follow all the recommendations regarding CO.

Familiarize your crew, passengers and yourself with the sources, symptoms and possible effects of carbon monoxide poisoning. Remember that boats in the same general vicinity can cause your vessel to accumulate dangerous CO levels in the cabin and or in the cockpit.

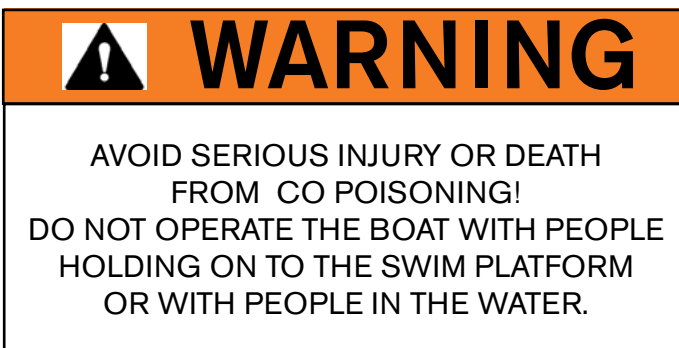

For safety sake avoid the following:

1. Do not park by other boats with their engine idling or generator cycling for an extended period of time.
2. Do not disable the carbon monoxide alarms that come with your Regal boat. Test the units in accordance with the alarm manufacturers instructions.
3. Do not operate an engine for extended periods of time while in a confined area or where exhaust outlets face a sea wall or bulkhead.
4. Do not operate the engine for an extended period of time with the canvas in the upright and installed position.
5. Do have the engine exhaust system inspected when the boat is in for service.
6. Persons sleeping can easily be overcome by carbon monoxide without realizing it. Do not sleep on board while an engine or generator is running close-by.
7. Do not operate your vessel for extended periods with the bow up in slow cruise conditions especially close behind a vessel being towed or one operating at slow speeds.
8. When underway open all hatches, windshield vents, and main cabin entry door to allow proper airflow from bow to stern.

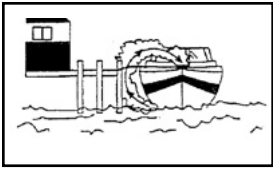

Blockage of exhaust outlets can cause carbon monoxide to accumulate in the cabin and cockpit area even

when the hatches, windows, portholes and doors are open. Sea walls and other confined spaces can cause CO levels to be dangerously elevated.

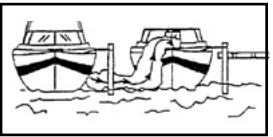

Exhaust from another vessel alongside your boat, while docked or anchored, can

emit poisonous CO gas inside the cabin and cockpit areas.

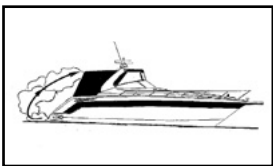

The “station wagon effect” or back drafting can cause CO gas to accumulate inside the cabin, cockpit/

hardtop or bridge areas when the boat is underway, using protective weather coverings (canvas), high bow angle, improper or heavy loading, slow speeds, or at rest. This can occur when traveling behind another boat.

How does CO affect us?

In high concentrations, CO can be fatal in minutes. However, the effects of lower concentrations over a extended period of time can be just as lethal.

Our blood uses hemoglobin to carry the oxygen we breathe to different body parts. Unfortunately, hemoglobin carries CO more readily than it does oxygen. The result is when we breathe in CO it replaces oxygen in our blood and we begin to suffocate. Also, when we are removed from the CO source it remains in our blood for hours causing long term effects. People have been known to become sick and even lose consciousness hours after exposure.

Carbon monoxide accumulation requires immediate

attention! Thoroughly ventilate cabin and cockpit areas. Determine the probable source of the carbon monoxide and correct the condition immediately. Anyone with symptoms of CO poisoning should be placed in a fresh air environment and medical attention found immediately. Regal has installed CO detectors on your boat. Have these detectors professionally calibrated at regular intervals according to the equipment manufacturer’s recommendations.

### A Few Notes About Diesel/CO Poisoning

The diesel engine under normal combustion produces much smaller amounts of CO. Therefore, it is far less likely to be fatal to a healthy person. Other factors including weather, temperature and engine condition can greatly affect the unsafe build-up of CO.

*Be aware that engine and generator diesel exhaust can exist from someone being in a close mooring to your vessel and running the generator all night. Diesel exhaust in the combustion process produces various components and the captain must be aware that the build-up of these select components over a period of time can cause CO or seasickness like symptoms.*

These include carbon dioxide, carbon monoxide (CO), nitrogen dioxide, nitric oxide, sulfur dioxide and others.

A healthy person breathing in sulfur dioxide over a period of time through a diesel engine or generator exhaust can develop nausea. This condition is not life threatening but the person may exhibit CO poisoning or seasickness symptoms. Just never rule out that it could be CO poisoning! Immediately find the source of the problem and move the individual to a fresh air environment!

Symptoms of excessive exposure to carbon monoxide (CO) are:

- Dizziness
- Drowsiness
- Nausea
- Headache
- Ringing in the ears
- Throbbing temples
- Watering, itchy eyes
- Flushed appearance
- Inattentiveness
- Incoherence
- Fatigue or vomiting
- Convulsions

**! DANGER**

CARBON MONOXIDE IS A TASTELESS, ODORLESS AND INVISIBLE GAS THAT CAN CAUSE DISCOMFORT, SEVERE ILLNESS, AND EVEN DEATH. EXERCISE CAUTION WHILE OPERATING GENERATOR OR ENGINES IN CONFINED SPACES OR AT DOCK SIDE. DO NOT ALLOW HULL EXHAUST OUTLETS TO BECOME BLOCKED OR EXHAUST FUMES CAN BECOME TRAPPED IN AND AROUND THE CONFINES OF YOUR BOAT. DURING IDLE AND SLOW CRUISE CONDITIONS, BILGE BLOWERS SHOULD BE USED.

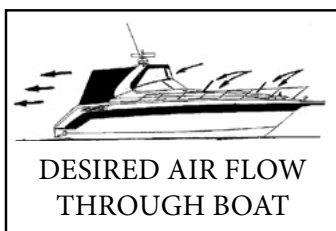

To help prevent carbon monoxide (CO) accumulation, ventilate your cabin and cockpit while

underway. Open a forward hatch, porthole or window to allow air to travel through the boat's interior and cockpit. See the illustration for desired airflow.

*NOTE: Never occupy moored boat with engines running and/or canvas completely covering vessel.*

**! WARNING**

INSPECT THE EXHAUST SYSTEM. IMMEDIATELY REPAIR OR REPLACE LEAKING, CRACKED AND CORRODED, OR MISSING EXHAUST COMPONENTS.

- Before each trip inspect engine and all systems.
- Make sure all exhaust hose clamps are in place.
- Look for exhaust leaking from the exhaust system components, indicated by rust and or black streaking, water leaks, or corroded or cracked fittings.
- Inspect all rubber exhaust hoses for burned or cracked areas. All rubber hoses should feel soft and and be free of kinks.
- Do not obstruct or modify the ventilation system.
- Keep an ear tuned for changes in exhaust sound that may be an exhaust component malfunction.

Do Not Operate the Vessel If **Any** of the above conditions exist. Contact a marine professional!

**NOTICE**

CARBON MONOXIDE PRECAUTIONARY LABELS ARE LOCATED AT THE HELM, TRANSOM AND CUDDY CABIN. ENSURE THAT ALL ABOARD READ AND UNDERSTAND THE SIGNS AND EFFECTS OF CARBON MONOXIDE (CO).

## Boating & Alcohol



Operating a vessel while intoxicated became a specific federal offense effective in 1988. The ruling set federal standards for determining

when an individual is intoxicated. If the blood alcohol content (BAC) is .10% (.08 in some states) or higher for operators of recreational vessels being used only for pleasure are subject to a civil penalty up to \$1,000 or criminal penalty up to \$5,000, one year imprisonment or both. In some states the fines and imprisonment may increase significantly.

The effects of alcohol and drugs account for the highest single cause of marine accidents and deaths. Most deaths in boating accidents occur when someone falls into the water. Balance is one of the first things you lose when drinking alcohol or under the influence of drugs. The problem arises out of not knowing your balance is restricted.

Overall vision is reduced by alcohol especially at night, along with double or blurred vision. Peripheral vision is lessened which restricts seeing vessels or objects on the side. Also, color awareness decreases especially with red and green which happen to be the colors of boat navigation lights, buoys, and channel markers.

Alcohol will greatly increase your heat loss so it increases the effects of hypothermia. Finally, your ability to make correct judgements in emergency situations is greatly reduced. Alcohol takes away the brains ability to process information quickly and delays a persons reaction time.

Don't drink and drive!

## Alcohol Myths & Facts:

**Myth:** Beer is less intoxicating than other alcoholic beverages.

**Fact:** One 12 oz. can of beer has about the same amount of alcohol as a 5oz. glass of wine or a shot of liquor.

**Myth:** Black coffee, fresh air, and a shower will sober the effects of alcohol.

**Fact:** After consuming alcohol time is the only thing that will sober you up. Our bodies average burning 1 oz. of alcohol every hour. If a person is drunk, it will take a person seven or more hours to sober up.

**Myth:** Telling if a person is too drunk to operate a vessel is easy.

**Fact:** Many experienced drinkers have learned to compensate for the visual effects of alcohol and can disguise their drunk condition.

**Myth:** You can judge if you are fit to operate a boat.

**Fact:** Judgement is one of the first elements you lose when drinking.



## Boating Accidents

The following is a list of common causes of boating accidents. Be aware of them and take the necessary steps to ensure that yourself and crew are educated and prepared to act in an emergency.

1. Mixing boating and alcohol. Remember, the skipper is responsible for his crew, passengers and vessel.
2. Trying to reach the bow by the deck walk-around at unsafe speeds. Use the center walk-through.
3. Someone sitting on the bow, deck, or swim platform while underway.
4. Choosing a boating outing day with inclement weather, especially in high winds and thunderstorms in the forecast or staying out when bad weather is approaching.
5. Disembarking without checking all the fluids or systems, and especially fuel system components.
6. Not monitoring the boating traffic or possible obstructions around you.
7. Emergency communications equipment, signaling devices, and navigation lights not working.
8. Improper boat handling especially high speed turns in rough water. Using trim improperly.
9. Being too far from shore with inadequate fuel supply or navigational aids.
10. Passengers, especially children that are not wearing the proper life saving devices.
11. Skipper or passengers not seated in the boat.

### Reporting Boating Accidents:

According to the Federal Boat Safety Act of 1971 involving collision, accident or other casualty, the operator must make a formal report within 48 hours to the nearest state boating authority when the incident involves:

1. Death
2. Injury requiring treatment other than first aid
3. The disappearance of someone from a boat under death or injury circumstances.

A formal report must be made within 10 days for accidents involving more than \$2000 damage or complete loss of vessel.

For information regarding accident reporting, please call the Boating Safety Hot-line at: 800-368-5647.

If there is no state provision for reporting boating accidents a report must be made to the Coast Guard officer in charge, Marine Inspection Unit nearest to the accident site or USCG station.

## Federal Regulations Regarding Vessel Security

Federal maritime regulations contain specific information when operating near naval vessels, oil tankers and cruise ships.

1. You may not approach within 100 yards of any U.S. naval vessel, oil tanker, or cruise ship. When this is impossible to avoid, you must contact either the vessel or the Coast Guard escort vessel on channel 16 of the VHF radio.
2. Also, you must operate at minimum speed within 500 yards of these vessels.

## Rendering Assistance

The operator of a vessel is obligated by law to provide assistance that can be provided safely to any individuals in a dangerous situation on the waterway. The operator is subject to fine and or imprisonment for failure to do so.



# DANGER

AVOID BODILY INJURY OR DEATH FROM FALLING OVERBOARD! ALL OCCUPANTS SHALL STAY SEATED IN THE COCKPIT WHILE THE BOAT IS RUNNING.



# WARNING

**Do not approach within 100 yards of any U.S. naval vessel.** If you need to pass within 100 yards of a U.S. naval vessel in order to ensure a safe passage in accordance with the Navigation Rules, you must contact the U.S. naval vessel or the Coast Guard escort vessel on VHF-FM channel 16.

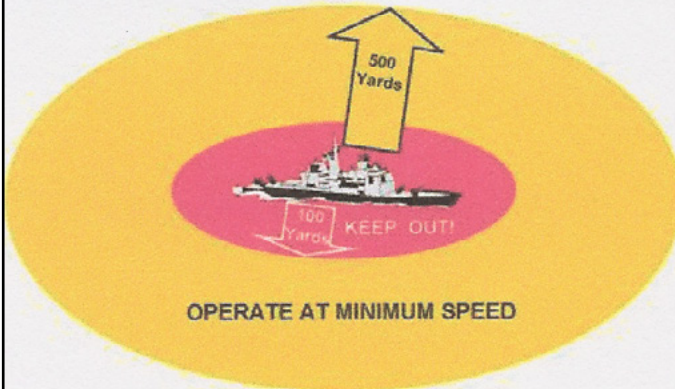

**You must operate at minimum speed within 500 yards of any U.S. naval vessel** and proceed as directed by the Commanding Officer or the official patrol.

Violations of the Naval Vessel Protection Zone are a felony offense, punishable by up to 6 years in prison and/or up to \$250,000 in fines

## Water Sports

Besides learning the safety precautions for safe boating, as well as understanding and knowing required rules and regulations you are obligated to be particularly careful around other water sportsman, such as scuba divers, water skiers, wake boarders, and fisherman.

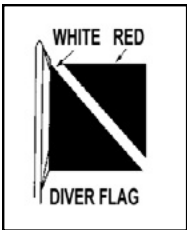

When ever you see a “Diver Down” flag maintain a distance of at least 100 feet on inland waters. In bays and open waters stay 300 feet away. The flag indicates a diver in the water. If a diver is operating from your boat, be certain to use this flag and post a lookout on board to observe the diver’s air bubbles.

## Swim Platform

On all types of swim platforms you should make periodic inspections of the swim ladder and hardware that support the platform to ensure that all connections and fittings are tight and in good condition. Always insert ladder and secure in the locked position before making headway!

Use heed when operating the boat in reverse to insure that water does not accumulate excessively on the platform or transom, especially in rough seas or strong currents. If installed, do not exceed the recommended maximum capacity label!

Typical label shown (varies by platform type/model).



## WARNING

AVOID SERIOUS INJURY OR DEATH!  
DO NOT OPERATE THE BOAT  
WITH PEOPLE IN THE WATER  
ON TOP OR HOLDING ON TO  
THE SWIM PLATFORM STRUCTURE.

*Read and understand the warning label above regarding “teak surfing.”*

## Fishing

Most boaters fish from time to time. With the propulsion systems of today it is possible to fish in out-of-the-way places. When cruising, stay clear of fisherman. They may have lines or nets out which might be cut or get caught in your propeller if you come too close. Slow down when approaching fishing boats. Do not return to cruising speed until the boats have been passed. If a fishing boat should be anchored, a large wake could flip or swamp the boat, upset fishing gear, pull the anchor loose from the bottom or worse yet cause someone to fall overboard.

When fishing from your boat, never anchor in a shipping channel or tie up to any navigational aid. These must be kept clear of at all times. Be sure to carry a local chart of the area to back up your plotter and be on the lookout for shallow water and hidden obstructions. Many times local conditions change and there is a time lag on the plotter chip until the next revision. Pick up a tidal chart if appropriate so you do not end up grounded.

## Weather / Water Conditions

Before a boating outing check the weather conditions. As we all know the weather can change rapidly in many parts of the country. It does so sometimes without being predicted. NOAA weather radio reports are continuously available on designated frequencies installed on VHF radios and various hand held devices. Also, many local radio stations carry weather reports along with on-line information.

### Cloud Formations:

Clouds indicate the type of current weather and upcoming changes in the weather. Knowing the type of cloud formation can assist you in understanding current weather. Flat clouds (stratus) normally indicate stable air. Cumulus clouds indicate unstable air.



Many times a "cotton ball" or cumulus cloud builds vertical height in the afternoon and the result is a thunderstorm with increased winds and waves; sometimes these storms are quite violent.

Also, water spouts with high vortex winds can develop over water. You can find additional weather information (meteorology) at your local library or on the internet.

## Waves & Fog

As the wind blows across water waves are created. The stronger the wind and increased distance across the water enlarges the wave action. Other factors that can cause problem situations for vessels are fog, currents, and tidal changes.

Fog can develop inland on clear, calm mornings. Coastal areas see large "blankets" of fog roll in and stay for extended time periods sometimes causing hazardous navigation conditions. If you are caught in the fog, do not panic. Think of the best plan of action and proceed carefully. If you are limited in navigation equipment at the first sign of fog proceed to the nearest shoreline and wait until the fog lifts.

Boats equipped with navigation equipment, local waterway experience and charts should proceed to a safe harbor. Use extreme caution, signal as needed, and reduce to a speed where you can stop within half of your forward vision range.

If foul weather catches you at sea do the following:

1. Slow down. Proceed with caution and put on your life vests.
2. Try to reach the nearest safe shoreline.
3. Navigate your vessel slowly into the waves at a 45 degree angle.
4. Passengers should sit low in the center of the vessel.
5. Monitor your bilge pump. Make sure sump stays free of water.
6. Secure loose gear. Make ready emergency equipment.
7. Anchor over the bow but never over the stern.

# Chapter 3

## Rules Of The Road

### Navigation Rules Defined

The Navigation Rules set forth actions to be followed by boats to avoid collision. They are referred to as the “Rules of the Road”. There are two main parts referred to as the inland and international rules. The inland rules apply to vessels operating inside the boundaries of the United States. The international rules (referred to as 72 COLREGS) apply to vessels operating on the high seas and all connected waters outside the established demarcation boundaries. Most navigational charts show the demarcation lines by red dotted lines and are published in the navigation rules. Remember to consult state and local agencies since areas such as “no wake zones,” swimming beaches, “diver down flag” and inland landlocked lakes fall under their responsibilities. This section is only an introduction to the “rules of the road”. We strongly recommend additional training before getting behind the “wheel”.

Order Inland & International Navigation Rules from:

Superintendent of Documents  
U. S. Government Printing Office  
Washington, DC 20402  
Tel: (202-512-1800) Fax:(202-512-2250)



### Navigation Rules

Right Of Way:

1. Cross waves at right angles.
2. When caught in heavy water or squalls, head either directly into the waves or at a slight angle. Reduce speed, but maintain enough power to maneuver your boat safely.
3. Keep your speed under control. Respect the rights of other boaters engaged in all water sports. Give them plenty of operating room.
4. Whenever meeting a boat head on, keep to the right where possible.
5. When two boats cross, the boat to the right (starboard) has the right of way.
6. When overtaking or passing, the boat being passed has the right of way.
7. In general, boats with less maneuverability have right-of-way over more agile craft. The skipper must keep his craft clear of the following vessels:
8. A vessel not under command or aground; due to their circumstances, these vessels have no maneuverability.



9. A vessel restricted in its maneuverability; these vessels usually are performing work which limits their maneuverability. Examples are boats surveying, dredging, laying pipe or cable, or servicing navigational markers.
10. A vessel engaged in fishing; these include boats fishing with lines, trawls or nets, but not trolling lines.
11. Sailboats; they have the right-of-way over powerboats. However, if a sailboat is using a prop to move forward, it is considered a powerboat even if the sails are up.
12. Remember the unwritten "rule of tonnage". Basically a smaller tonnage vessel should take every effort to avoid close quarters with a larger tonnage vessel. One way to accomplish this is to have a designated human lookout to "eyeball" the horizon for any developing collision course.
13. Use defensive driving skills on the waterway just as you do on the roadway. The other vessel may not know the rules of the road. Be alert and ready to take immediate action.
14. If a collision course is unavoidable neither boat has the right of way. Both boats must react to avoid an accident according to the rules of the road.

### Lookouts:

International and Inland navigation rules spell out the specifics of establishing a lookout. A lookout is legally defined by the court system as a person who has specifically charged duties on board such as observing sounds, echoes, lights and any inhibitors to navigation with complete thoroughness as permitted by the circumstances.

The term "specifically charged" means that the lookout has no other duties at that time that could prevent him from keeping a proper watch.

Of course the skipper must delegate the lookout duties to a seasoned crew member who can react to events quickly and communicate effectively with the captain with little notice.

As captain of your vessel you are responsible for the vessel and the crew. Choose an experienced individual as lookout and review the navigation rules with this person so he can make the right call quickly as situations develop.

<b>WHISTLE SIGNALS</b>	
<b>ONE LONG BLAST:</b>	Warning signal (Coming out of slip)
<b>ONE SHORT BLAST:</b>	Pass on my port side
<b>TWO SHORT BLASTS:</b>	Pass on my starboard side
<b>THREE SHORT BLASTS:</b>	Engine(s) in reverse
<b>FOUR OR MORE BLASTS:</b>	Danger signal

<b>BRIDGE SIGNALS</b>		DAY (Flag)	NIGHT (Lights)
<b>SOUND</b>	<b>VISUAL</b>	↑	↑
VESSEL: Open	VESSEL: Open	□	○
BRIDGE: OK	BRIDGE: OK	↓	●
No	No	or	or
VESSEL: Replies:		Same	Same
RADIO: VHF CH. 13			

## Navigation Rules

The Navigation Rules set forth 3 types of crossing situations- crossing, meeting, and overtaking. In each case, both boats are governed by special procedures.

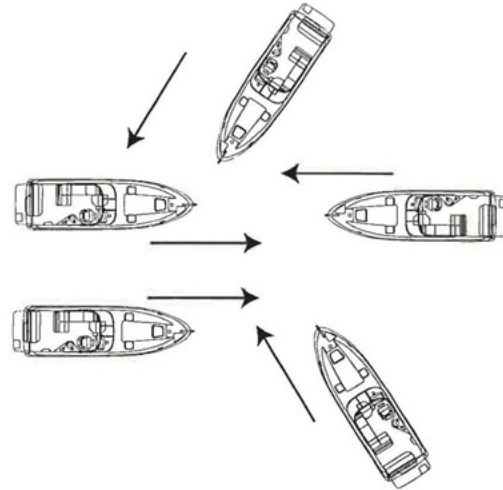

In a head-on meeting, both vessels must sound a single blast to give way toward starboard and pass to port.

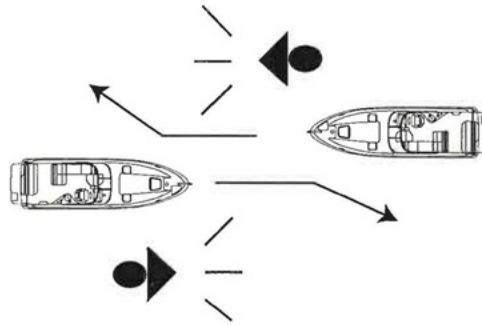

These rules appear when there is a risk of collision. In a crossing situation be aware of the other craft's position. For safety, there should be a noticeable change in the angle, bow or stern; a gradual change in position indicates possible danger.

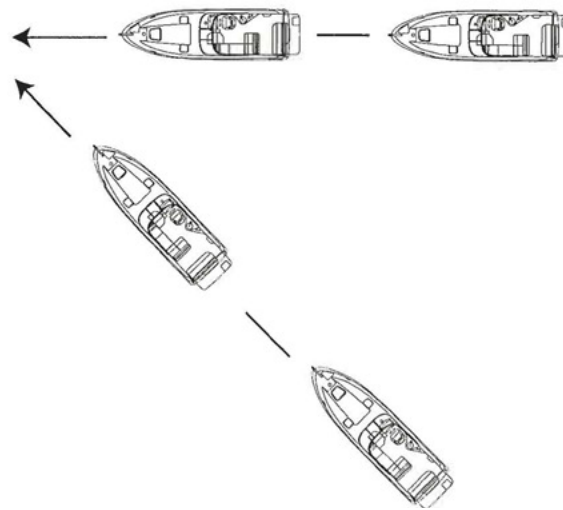



## Navigation Rules

An overtaking boat is burdened, and is not the privileged craft, even though it approaches the danger zone of the overtaken boat.

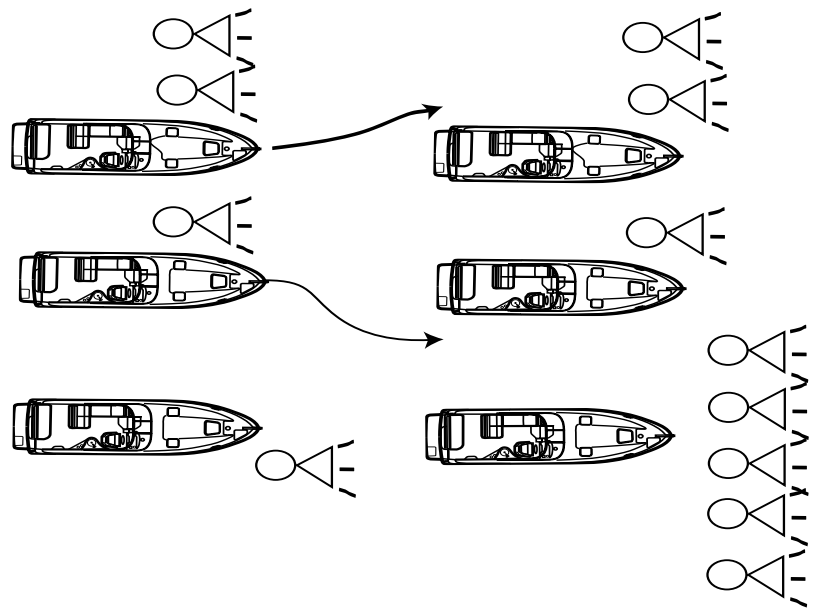
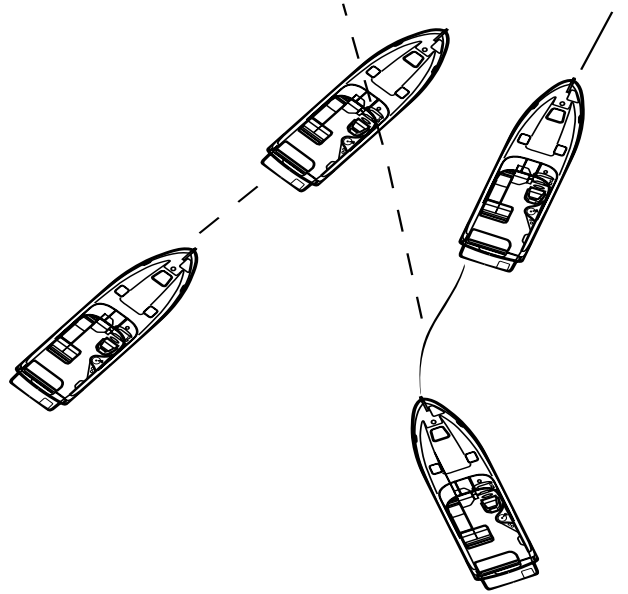

The overtaking boat first signals with a single blast if that boat desires to pass on the starboard side of the boat ahead, or a double blast if passing to port. The overtaken craft responds with the same signal if safe, or with the danger signal (5 short blasts or more) if unsafe. The boat overtaking must not pass unless the appropriate signals are sounded.

## Navigation Aids

Navigation aids are placed along coasts and navigable waters as a guide for mariners in determining their position in reference to land and hidden danger. Each aid provides specific information. They form a continuous system of charted markers for monitoring on the plotter or providing accurate piloting on paper as a backup. Your on board plotter provides up to date navigation aids. Besides coastal maps a complete domestic interior waterway grid is featured on the plotter.

If desired, there are hand-held GPS devices that are available as back-up devices. In addition, nautical charts are provided by the National Ocean Service (NOS) and are distributed nationwide through marinas and outlet stores. These charts show the geography of the coast, water depth, landmarks, navigation aids (buoys and markers), marine hazards, and port facilities. Use only up-to-date charts for navigation. We recommend when purchasing a chart to look for the weather resistant ones. Buoys provide a road map to keep the skipper on course and to avoid hazards. Buoys are identified by light, shape, color and in severe weather conditions by sound.

Buoys or beacons called lateral markers indicate the port and starboard sides of the waterway to be followed. U. S markers follow the buoy system known as Red Right Returning. When returning from sea or traveling upstream, the green markers are to port (on your left) and the red markers are to the starboard side (on your right). When traveling downstream or out to sea the marker color would be reversed.

Before operating your vessel, learn to identify the various navigational aids such as lateral aids, mid-channel markers, information and regulatory markers.

# NOTICE

SKIPPERS MUST NOT RELY ON BUOYS ALONE TO MARK THEIR POSITION. SEVERE WEATHER CONDITIONS AND WAVE ACTION CAN ALTER A BUOYS POSITION. NEVER TIE UP TO A BUOY. IT IS ILLEGAL AND DANGEROUS.



**NAVIGATION AID PUGET SOUND**

# Lateral Aids

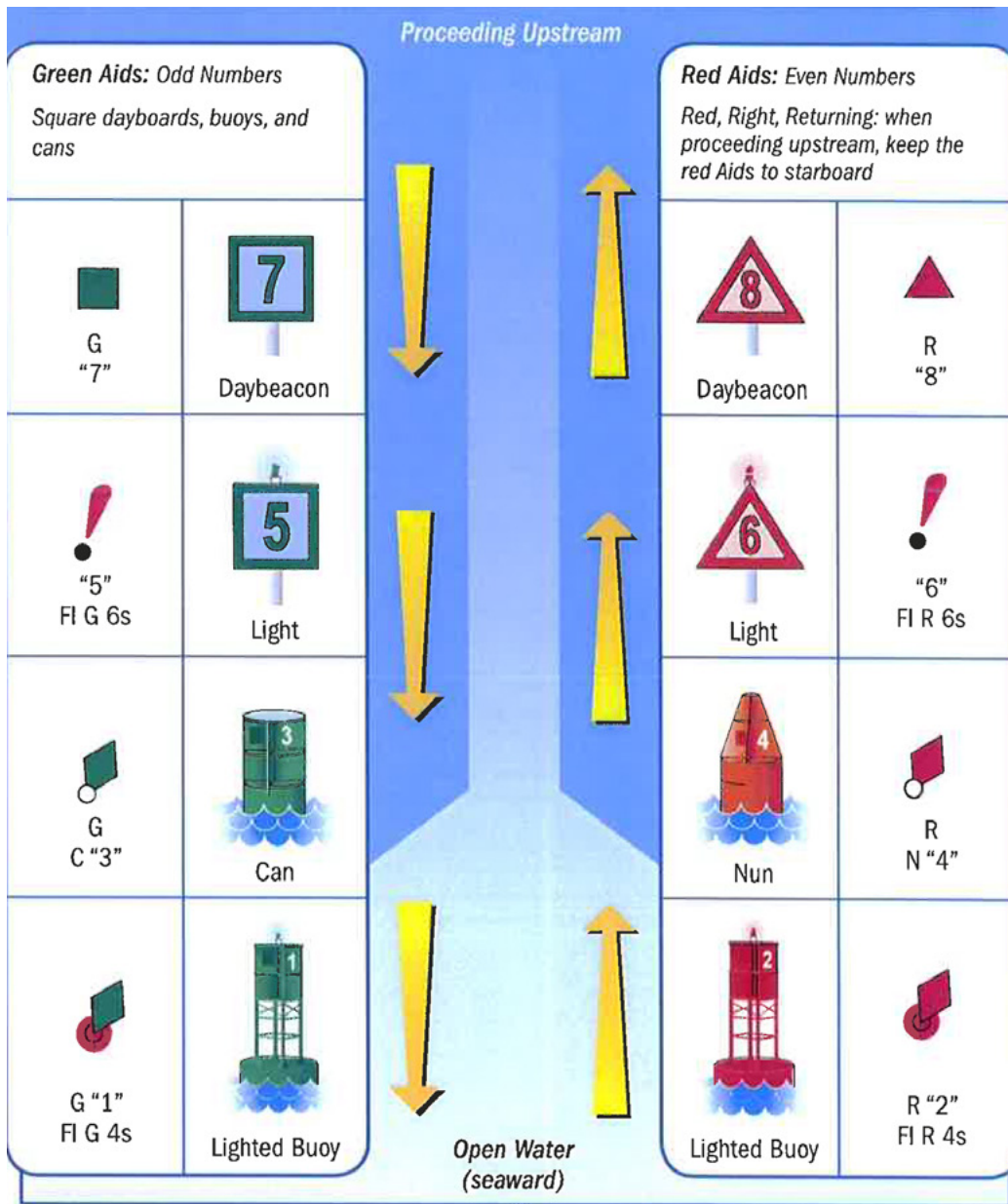

### Characteristics

- Beacons may have green odd numbers.
- Buoys may have white odd numbers.
- If lit, the light will be green and is likely to flash in one of the following patterns:













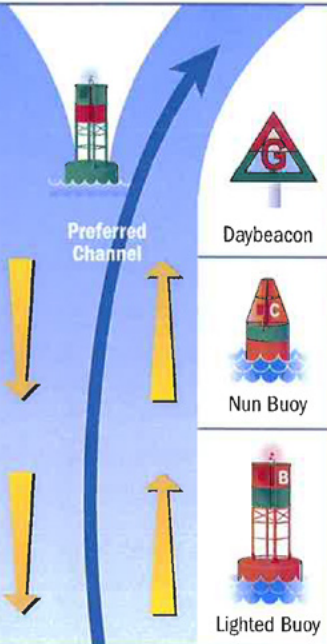

Flashing (2)	
Flashing	
Occulting	
Quick Flashing	
Isophase	







### Characteristics

- Beacons may have red even numbers.
- Buoys may have white even numbers.
- If lit, the light will be red and is likely to flash in one of the following patterns:

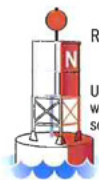
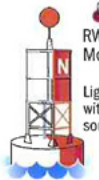











Flashing (2)	
Flashing	
Occulting	
Quick Flashing	
Isophase	

# Channel Markers

 GR "U"	 Daybeacon	 <p style="text-align: center;">Preferred Channel</p>	 Daybeacon	 RG "G"
 GR C "S"	 Can Buoy		 Nun Buoy	 RG N "C"
 GR "A" Fl (2+1) G 6s	 Lighted Buoy		 Lighted Buoy	 RG "B" Fl (2+1) R 6s
<p><b>Characteristics</b></p> <ul style="list-style-type: none"> <li>Green on top.</li> <li>Have a letter designation.</li> <li>Buoys will feature a white letter.</li> <li>If lit:  COMPOSITE GROUP FLASHING (2-1)</li> </ul>		<p><b>Characteristics</b></p> <ul style="list-style-type: none"> <li>Red on top.</li> <li>Have a letter designation.</li> <li>Buoys will feature a white letter.</li> <li>If lit:  COMPOSITE GROUP FLASHING (2-1)</li> </ul>		

 RW "N" Unlighted with or w/o sound	 RW "N" Mo (A) Lighted with or w/o sound	
<p><b>Characteristics</b></p> <ul style="list-style-type: none"> <li>White and red vertical stripes.</li> <li>A variety of shapes.</li> <li>May be lettered.</li> <li>Buoy may have red topmark.</li> <li>If lit:  (Morse Code 'A')</li> </ul>	 RW "A" MR	 SP "G" Spherical
		 RW "N" Can

# Regulatory Markers

Symbol	Meaning	Examples
	<p><b>Danger</b></p> <p>A diamond shape alerts boaters to hazards</p>	 
	<p><b>Restricted Operations</b></p> <p>Marks with a circle indicate areas with regulated operations</p>	 
	<p><b>Exclusion</b></p> <p>A diamond shape with a cross means boats are prohibited from the area</p>	 
	<p><b>Information</b></p> <p>Marks with a square provide helpful information such as directions, distances, and locations</p>	 



## Night Running

Boats operating between sunset and sunrise (hours vary by state), or in conditions of reduced visibility, must use navigation lights. Night time operation, especially during bad weather and fog, can be dangerous. All Rules of the Road apply at night, but it is best to slow down and stay clear of all boats regardless of who has the right-of-way.

To see more easily at night, avoid bright lights when possible. Also, it is helpful to have a passenger (appoint as lookout) keep watch for other boats, water hazards and navigational aids.

To determine the size, speed and direction of other vessels at night, you should use the running lights. A green light indicates starboard side, and a red light indicates port side. Generally, if you see a green light, you have the right-of-way. If you see a red light, give way to the other vessel.

## Bridge Clearance

Be aware that your vessel requires a specified bridge clearance height. This height is a measured

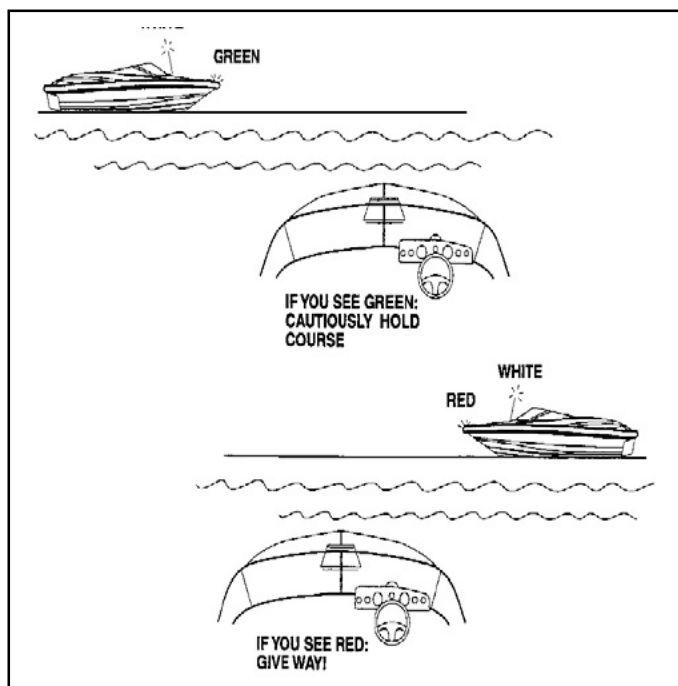

estimate from the waterline to the top of the highest equipment height. The estimated height can change because of variances in the loaded condition of the vessel and equipment variances. Consult the bridge clearance specifications located in Chapter 12 (Technical Information section). Some bridges are tendered. Know and use the proper bridge signals when approaching these bridges (see bridge signals in this chapter). You can also monitor and communicate on channel 13 of a VHF radio for bridge information in most domestic locals. Other bridges are marked with a clearance measurement and you are on your own. It is recommended that you have a look out posted for additional visual assistance when entering a bridge zone.

After determining your vessel will clear the bridge proceed with caution at a safe idle speed. Keep your eye on vessel traffic at all times in order to react quickly. Keep both hands on the helm since you may need to change course because of current and wind conditions. Resume a safe speed once clear of the bridge structure and acknowledgment of clear visibility. Just use common sense around any type of bridge structure!

## Bridge Lighting:

Bridge lighting is maintained by the Department of Homeland Security. On the following pages are 2 typical examples of night-time bridge lighting. As the skipper approaches bascule and fixed bridges light position (arc of visibility) and color will indicate the safe channel through the bridge. Notice green denotes the "safe" entry location on single-span bridges and green or white on multiple-span bridges designates the main channel. In addition, green denotes the "up" position for single and double lift bridges.

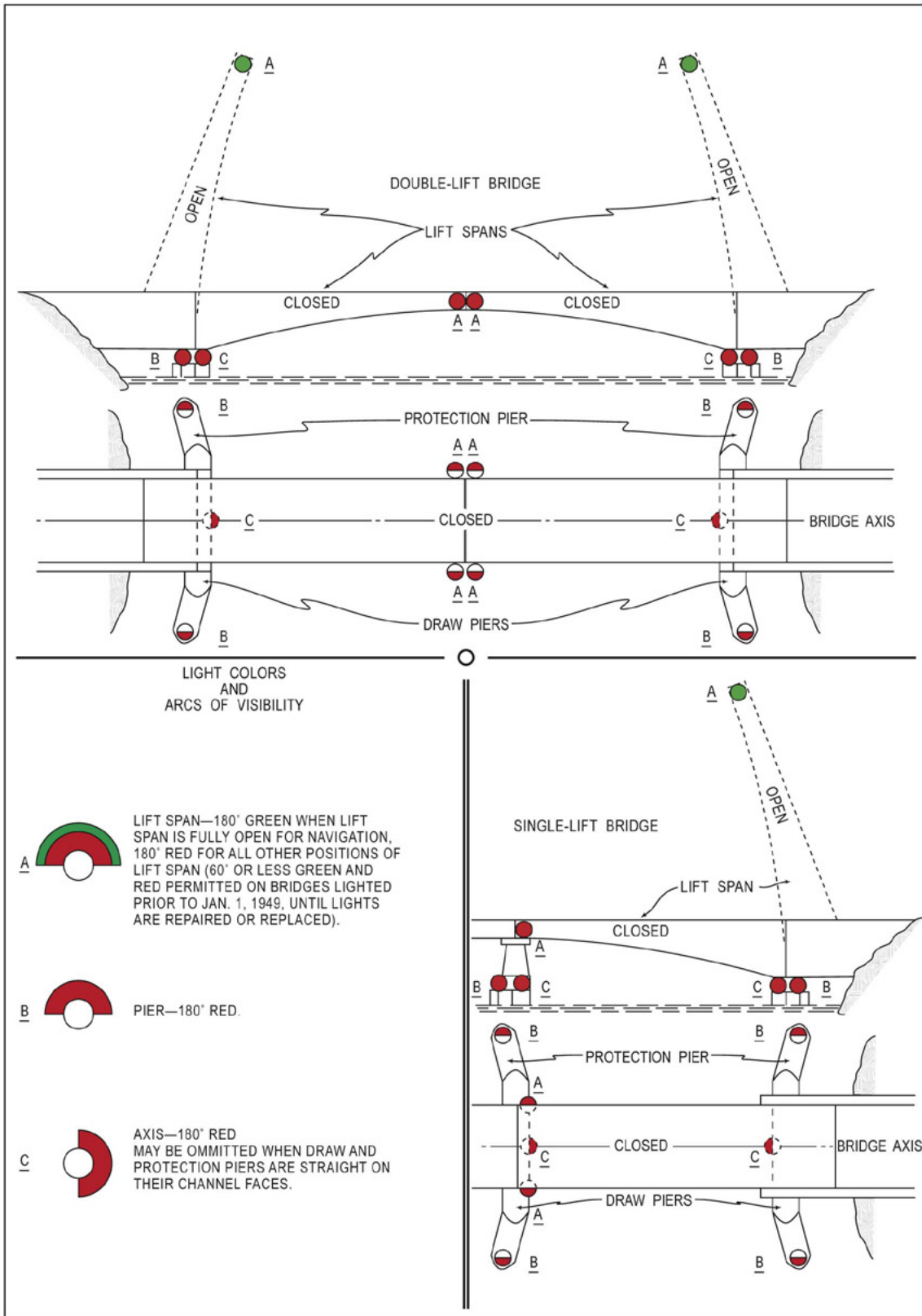

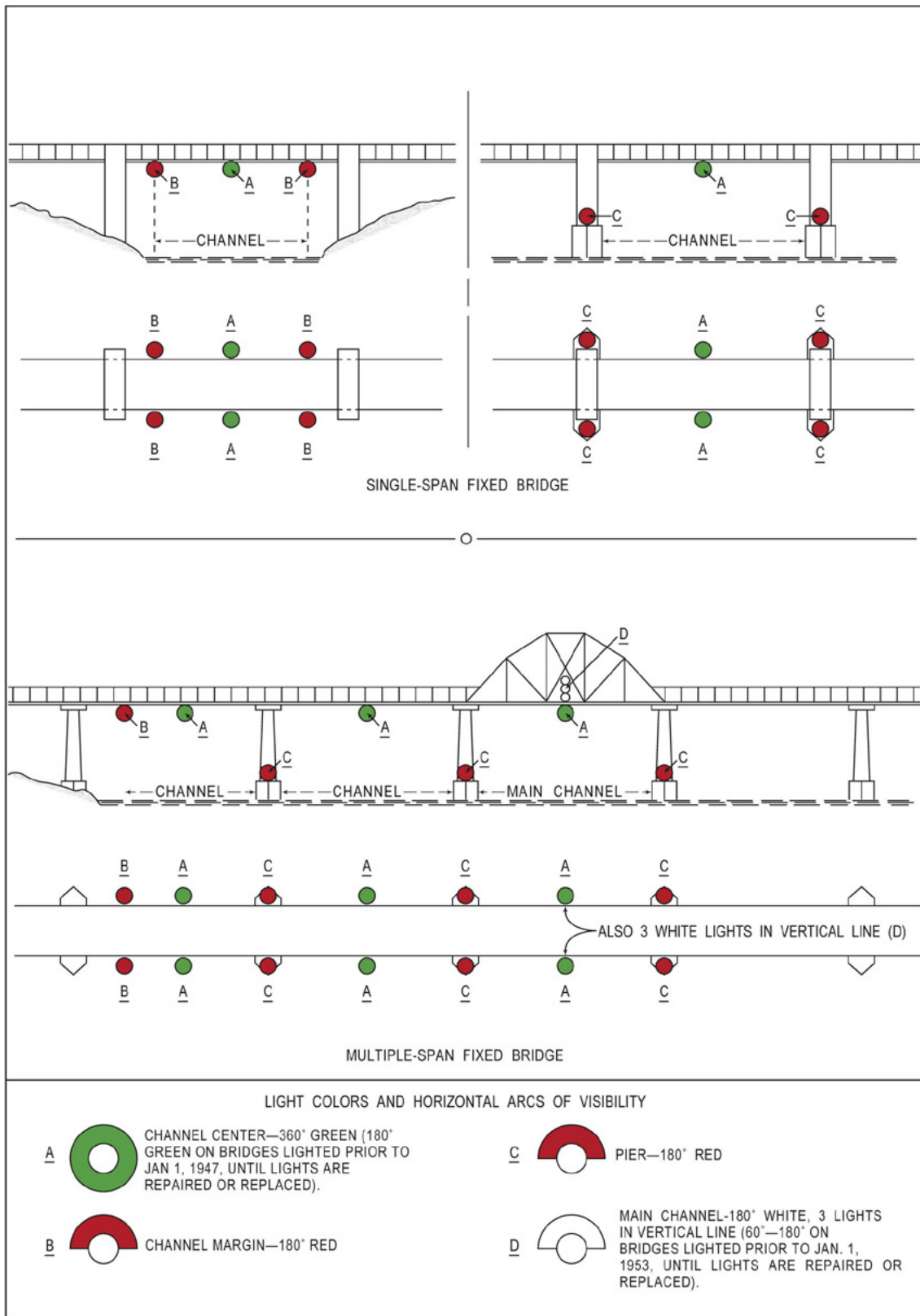



# Chapter 4

## Systems

### Overview

In this chapter Regal on board standard systems are introduced. These systems typically represent arrangements found on the LS2, LS2 Surf stern drive models along with the LX2 outboard. Information includes several main systems including electrical, fuel, waste, and entertainment. In short, this chapter is the “meat and potato” section for systems. Select optional equipment and systems are found in Chapter 7.

A system description, location of components, and operational information is found in this section. Enhanced vendor component details and troubleshooting can be found in the owner’s information packet along with the troubleshooting chapter of this manual.

*Be sure to read and follow any danger, warning, or caution labels in reference to boat systems or individual equipment components.*

*Note that your Regal boat may not contain all of the equipment or systems shown. Regal has the right to modify, update or delete equipment and/or systems at anytime. Refer to the vendor documentation located in the owner’s information packet for more detailed information of individual system components. Also, use internet search agents.*



## WARNING

PREVENT INJURY OR DEATH!  
READ AND UNDERSTAND THE ENGINE  
PROPULSION OWNER’S MANUAL  
BEFORE ATTEMPTING  
TO OPERATE THE VESSEL.

## Electrical System

### Introduction

In this section, basic DC (direct current) is introduced. Select electrical components are reviewed along with their location and function within the electrical system.

For more complicated issues outside the scope of this manual contact your closet Regal dealer. They have undergone extensive training on the Regal boat systems.

Be sure to read and follow any danger, warning, caution, or notice labels in reference to the vessel's electrical system or individual equipment components. Also, refer to the owner's information packet for further product information or the internet.

 **WARNING**

PREVENT SEVERE INJURY OR DEATH!  
DISCONNECT  
ALL ELECTRICAL POWER SOURCES  
BEFORE ATTEMPTING  
TO REPAIR OR REPLACE  
ANY ELECTRICAL COMPONENT.

 **CAUTION**

AVOID CHARGING SYSTEM DAMAGE!  
DO NOT TURN  
BATTERY SWITCH TO THE "OFF"  
POSITION WITH THE ENGINE RUNNING.

## DC Current

Your Regal boat uses 12 volt DC electricity otherwise known as direct current. It is called DC because it flows only one way in a circuit. Specifically to name a few, helm gauges, batteries, battery cables, engine electrical components, engine wiring harnesses, dash switches, selected lighting, shower sump, bilge pumps, and vacuum toilets are all components using a 12 volt DC system.

In the domestic DC system the red wire is designated as the "hot" or conductor wire and the black wire is referred to as the ground wire. At times other current carrying wires are color coded such as blue to identify their use as a low voltage conductor. This is especially helpful in troubleshooting and adding additional equipment. Be sure to review the wiring schematics in the drawing section of the technical chapter.

Direct current is stored in the ship's battery(ies) and produced through the engine alternator while the engine is running or by the battery charger (if installed) at shore. Normal DC voltage is between 12 and 15 volts. Lower or higher readings could indicate a charging malfunction or a weak battery.

*Note that current specifications for alternator output is around 105 amps depending on engine model. The forward bilge pump and automatic float switch are continuously on with the bilge pump switch in the middle or "off" position. Should a leak develop with the operator away from the vessel the bilge pump will continue to pump bilge water overboard until of course the battery goes dead.*

TYPICAL DC (12 VOLT) WIRING COLOR CODE & SIZES		
BLACK	16,14,12,10,8,6,4,2,2/0,40	GROUNDS
BLACK/WHITE	16	HALON INDICATOR
BLACK/YELLOW	10,16	GRD. DIESEL TRANSFER PUMP, MERC DIESEL STOP CIRCUIT
BLACK/WHITE	10	HALON MAIN GRD. FEED
BROWN/BLACK	10	MACERATOR, SUN ROOF
BROWN	10	SUN ROOF
BROWN	14	AFT BILGE PUMP-MANUAL
BROWN/WHITE	14	AFT BILGE PUMP-AUTO
BROWN/RED	14	FWD. BILGE PUMP-AUTO
BROWN/BLUE	14	FWD. BILGE PUMP-MANUAL
BROWN/PINK	16	CO DETECTOR
BROWN/BLACK	16	SHOWER SUMP PUMP
YELLOW	12,10	BLOWER
YELLOW/WHITE	16	HEAD VENT FAN MOTOR
YELLOW/BLACK	16	STEREO MEMORY
YELLOW/RED	14	ENGINE START CIRCUIT

Note: The list above applies to a number of vessels. Vessel components/wiring specifications may vary depending on the model.

TYPICAL DC (12 VOLT) WIRING COLOR CODE & SIZES (CONTINUED)		
ORANGE	10,12	VACUUM TOILET, REFRIGERATOR, HATCH RAM
ORANGE	16	WIPER RUN
ORANGE/WHITE	16	WIPER PARK
ORANGE/BLACK	10,12,16	HORN, HATCH RAM
BLUE	14	INTERIOR LIGHTS, SWITCHED CIRCUIT
BLUE/RED	14	INTERIOR LIGHTS, CONSTANT HOT CIRCUIT
BLUE/BLACK	16	COCKPIT SOFT LIGHTS
BLUE/GREEN	16	INTERIOR SOFT LIGHTS
BLUE	10	CABIN LIGHT MAIN CIRCUIT FEED
GRAY	14	NAVIGATION LIGHTS, RUN- NING, BOW, TRANSOM LIGHTS
GRAY/BLACK	14	NAVIGATION LIGHTS, AFT AN- CHOR, MASTHEAD
GRAY/WHITE	14	NAVIGATION LIGHTS, MAST- HEAD, FWD. RUNNING LIGHTS
RED	16	POSITIVE FEED- ELECTRON- ICS, GAS VAPOR DETECTOR, BREAKER TO DASH SWITCH FEEDS

Note: The list above applies to a number of vessels. Vessel components/wiring may vary depending on the model.

TYPICAL DC (12 VOLT) WIRING COLOR CODE & SIZES (CONTINUED)		
RED/WHITE	16	WINDLASS CONTROL-DOWN
RED/BLACK	16	WINDLASS CONTROL-UP
RED/WHITE	14	BATTERY PARALLEL-LOAD
RED	14	POSITIVE FEED-ELECTRONICS
RED	12	POSITIVE FEED-ELECTRONICS
RED	10	POSITIVE FEED-AUTO PILOT
RED/VIOLET	10	FUEL TANK TRANSFER PUMP AMPLIFIER POWER
RED	8	POSITIVE FEED- MAIN ALTERNATOR CHARGE
RED	6	POSITIVE FEED- MAIN ALTERNATOR CHARGE
RED	4	POSITIVE FEED-MAIN
RED	2	POSITIVE FEED- MAIN STARTER, BATTERY, GENERATOR
RED	2/0	POSITIVE FEED- MAIN, START- ER, BATTERY
PURPLE	16	STBD. IGNITION, HOUR METER- WINDSHIELD VENT
PURPLE/WHITE	16	PORT IGNITION, HOUR METER, WINDSHIELD VENT
PINK	16	STBD. FUEL TANK SENDER
PINK/BLACK	16	PORT FUEL TANK SENDER
TAN/BLUE	16	ENGINE ALARM CIRCUIT
GREEN	16	TANK LEVEL MONITOR, SPOT- LIGHT
GREEN	10	SPOTLIGHT
GREEN	8	BONDING

Note: The list above applies to a number of vessels. Vessel components/wiring may vary depending on the model.

## Batteries

All vessel DC equipment and specifications are subject to change at any time, as part of Regal's commitment to product improvement. Equipment information here is up to date per the owner's manual printing date.

## Battery Locations

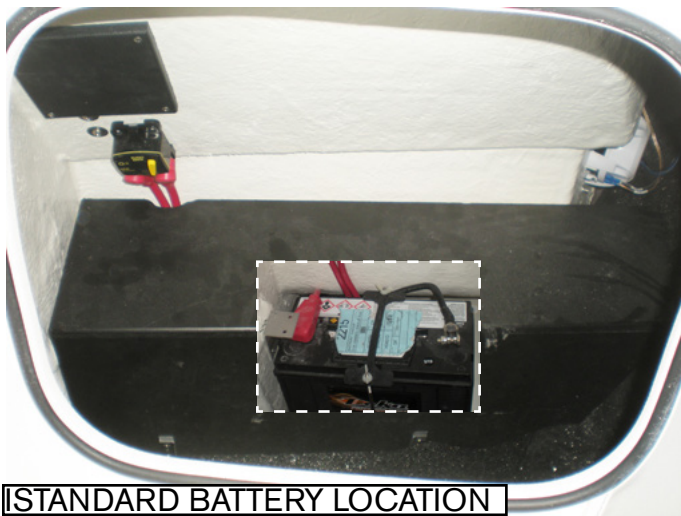

**One battery** is standard equipment on your vessel. It is located at the port bow. Raise up the backrest to afford access to the battery. Battery is located under a protective cover.

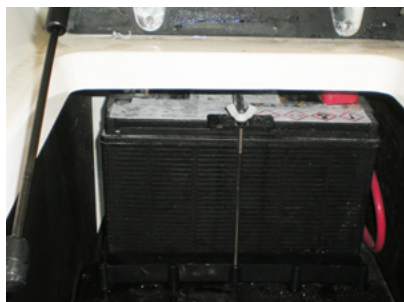

A second battery is used when the dual battery switch option is chosen. It is located under the port side of the aft bench seat.

*Note that the surf model batteries are at the same locations.*

BATTERY SPECIFICATIONS			
Battery Type	Group	CCA @32 Degrees F.	Reserve Capacity
Engine Cranking & House	31 A	1260	195 min.

Each battery uses a cover, box or tray along with fastening hardware. Be sure to periodically check maintenance style batteries for proper electrolyte levels and use only distilled water when filling cells. In addition, periodically check all hardware & fasteners for tightness.

## Battery Terminology Descriptions

Group- Batteries are divided into groups which identify the height, length, and width of the battery. This is useful information should a replacement battery become necessary. Note that current models use 31 A series batteries. Estimated weight is 60 pounds per battery.

Cold Cranking Amps (CCA)- This rating measures the cranking power of a full charged marine battery having the ability to start at 32 degrees F. Basically, the higher the rating the greater starting power of the battery.

Reserve Capacity (RC)- As usage on the boat increases so does the need for more reserve capacity. The reserve capacity represents the length of time in minutes a new fully charged battery can maintain the vessel's electrical needs without the engine running or in the event of alternator failure.

## Battery Problems/Solutions



1. Weak battery- This battery problem can be caused by low electrolyte cell levels.

Warm, bilge compartment temperatures will deteriorate a battery's life quicker by evaporating the water from the electrolyte, thus corroding and weakening the positive grids inside the battery.

Low electrolyte levels can be monitored by periodic inspection and filling as needed with distilled water. Boaters in higher climate areas with longer stretches of hot weather will need to check their batteries more often.

"Maintenance free" engine cranking batteries require no water and cells are not accessible. They do feature a different chemistry that does consume less water. Inside the cells as gases are released condensation is formed which aids in maintaining the cell electrolyte level. These batteries incorporate a deeper layer of electrolyte over the plates, but eventually it can run dry. On the 31 series engine cranking batteries keep all terminals clean, connections tight and your electrical system in top shape to extend battery life.

2. Dead Battery- Either the battery will not accept a charge, hold a charge or the charging system is not supplying a charging current through the battery charging system and/or engine alternators.

The battery charger output can be checked by monitoring the lights on the charger front face.

To begin with check the battery post connections for tightness and corrosion.

With the engine running the displayed voltage of the battery should be between 12.5 up to 14.6 volts.

If less than 12 volts check for voltage across the battery terminals.

If less than 12 volts check with a hydrometer to locate faulty cells.

Batteries can be removed from the vessel if necessary and trickle charged. If readings after charging are still low replace the battery.

*Note that when replacing batteries the battery charger will support AGM and flooded acid types but not gel types.*



## Battery Switches

Normally the engine cranking battery switch is located in the starboard sump on the battery management panel. To access the panel lift up the starboard aft seat/cushion. Here you will see 1 of 2 different battery switches.

Standard battery switch designates an “off” and “on” position. To start the engine position the battery switch at the “on” detent. Power is now available to the dash and to start the engine.

The engine battery switch is protected by a circuit breaker. Be sure to turn the battery switch to the off position when leaving the vessel. *Note: never turn the battery switch to the “off” position with the engine running.*

If installed a dual battery switch designates “off”, “on” and “combine batteries” positions. This particular battery switch is connected to dual batteries and this set-up supplies additional reserve capacity to run extra accessories and to supply cranking amperage to start the engine with the other battery in a low charge condition.

To use this feature position turn the battery switch knob to the “combine batteries” detent (yellow labeled area). At this point you can start the engine. As this particular battery switch features a “make before break” footprint once the engine starts you can reposition the battery switch to the “on” detent to revert back to one battery for engine starting. It is recommended not to leave the dual battery switch in the “combine batteries” position as under the right conditions a severe discharge could result in both batteries becoming “dead”.



TYPICAL OFF-ON BATTERY SWITCH



TYPICAL DUAL BATTERY SWITCH



## CAUTION

AVOID CHARGING SYSTEM DAMAGE!  
DO NOT TURN  
BATTERY SWITCH TO THE “OFF”  
POSITION WITH THE ENGINE RUNNING.

## Battery Management Panel



TYPICAL BATTERY MANAGEMENT PANEL (outside view) (OPT. DUAL BATTERY SWITCH SHOWN)

The battery management panel features key electrical components including battery switches, breakers, fuse panels and related battery charging components. The panel is accessed by lifting up the aft starboard cushion. Here are selected components you typically find on the panel:

1. This 50 amp breaker controls wiring to the dash sometimes called the helm. It protects the wiring circuitry from overloads and short circuits.

Activate the above circuit breaker by pushing the yellow lever down until it ratchets in the “on” position. It is shown in the “on” position above.

If the breaker should “trip” there will be no power to the dash or helm. Determine the cause before resetting the circuit breaker.

2. This fuse protects the stereo memory circuit. This permits you to keep all your stereo program selections when you leave your vessel even with the battery switch turned off.

3. This fuse protects the optional power swim platform circuitry.

4. This fuse protects the aft bilge pump which is usually found in the bilge just forward of the engine. When you leave the vessel and turn off the battery switch as recommended the bilge pump circuit is still activated allowing the pump to work should a leak develop.

5. This is the shore plug for the battery charger. It is recommended that you use a 3 prong extension cord rated for the amperage. Read and follow the label instructions below as we do not recommend using the shore cord while vessel is in the water.

6. There is a label placed close to the battery charger shore plug. Read and understand the following label. This type of damage caused by electrolysis is not covered by any warranty.

 **CAUTION**

THIS VESSEL IS NOT EQUIPPED WITH A GALVANIC ISOLATOR. USING THE BATTERY CHARGER WHILE THE VESSEL IS IN THE WATER MAY CAUSE DAMAGE TO THE BOAT'S ANODES AND/OR DRIVE SYSTEM!

7. Read and understand the electric shock warning label below. Use extreme caution when plugging into outlet for battery charging.

 **WARNING**

PREVENT SEVERE INJURY OR DEATH  
FROM FIRE, EXPLOSION  
OR ELECTRICAL SHOCK!

THIS DEVICE MUST BE CONNECTED TO A  
GROUND FAULT CIRCUIT INTERRUPT  
(GFCI) PROTECTED AC OUTLET.

WHEN USING AN EXTENSION CORD,  
CONNECT THE AC CHARGER PLUG  
BEFORE CONNECTING TO THE GFCI  
PROTECTED AC OUTLET!

MAKE CONNECTION IN AN OPEN  
ATMOSPHERE FREE OF EXPLOSIVE FUMES.

MAKE CORD AND CONNECTION IN A  
SECURE MANNER THAT WILL AVOID  
CONTACT WITH WATER.

8. The battery switch when in the “off” position disconnects any voltage to the dash including the engine key switch. Note that the standard off and on battery switch instead of the dual switch may be present on your battery management panel.



TYPICAL BATTERY MANAGEMENT PANEL (inside view)

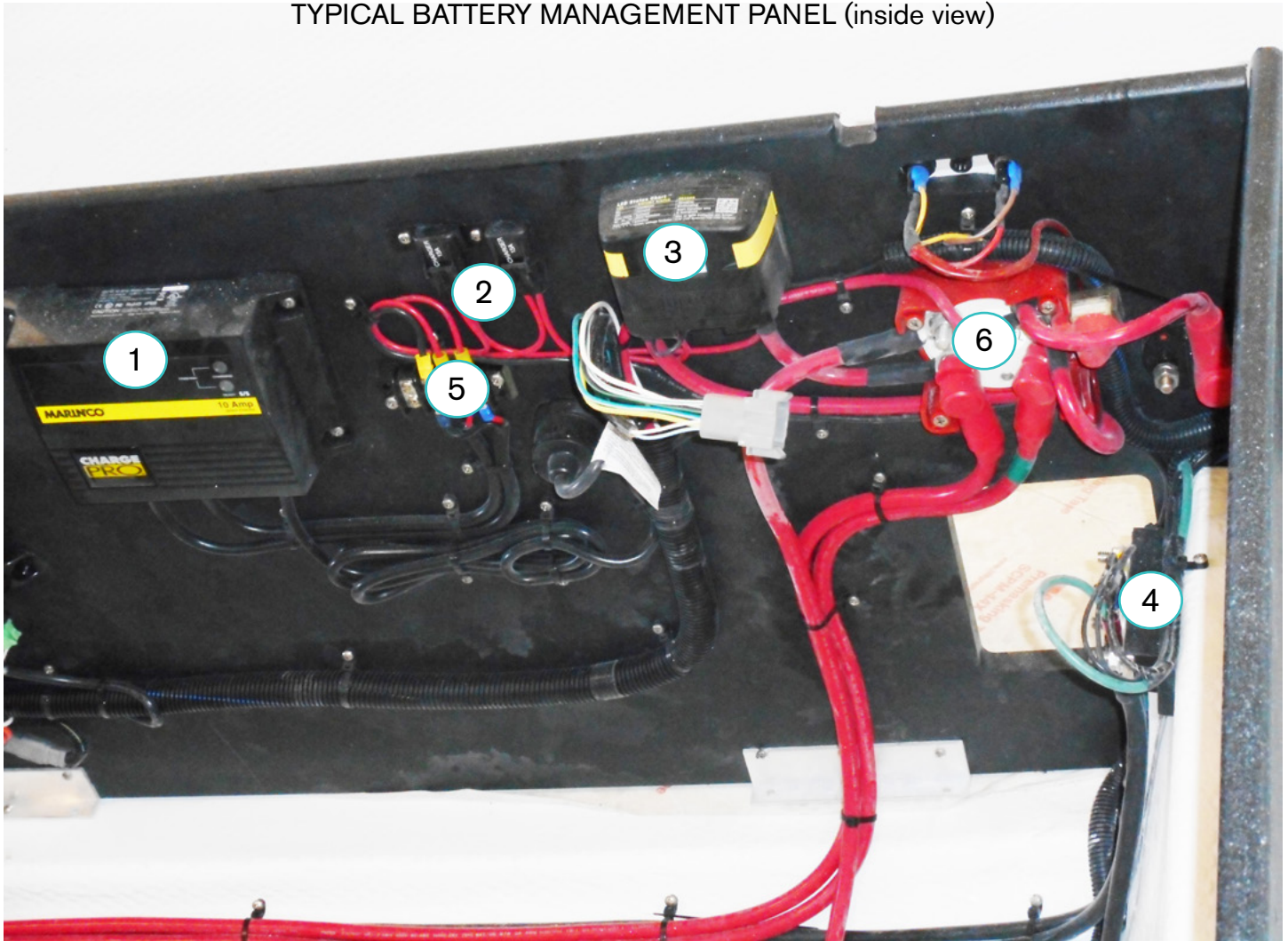

Above is the battery management panel shown as an inside view. This view would be facing the starboard side of the engine.

1. Shown is a 10 amp battery charger. If installed, it supplies DC current to assist in keeping the batteries charged at shore. Be sure to read and understand the recommendations on how and where to use the battery charger (see previous pages).

2. These 15 amp fuses protect each of the battery circuits. If the positive and negative battery cables are somehow reversed these breakers could trip.

3. The automatic charging relay (ACR) controls the flow of charge current from the battery charger to the appropriate battery. The ACR is only used on the dual battery switch system.

The ACR requires no maintenance and there are no adjustments since it is a digital component but check the wires periodically for tightness.

*Note to read and understand any safety labels relating to the battery charging procedure and using an extension cord.*

## Battery Management Panel (Continued)

4. The ground block is a home for a group of negative (black) wires. You may even find an earth ground on the block (green). This may be an additional ground area for added accessories. Periodically check to ensure all wires are fastened securely.

*Note when adding accessories never add more than 4 connectors to any stud on a ground block and place on stud larger wires first; then smaller wires before tightening the stud nut.*

5. This bank provides a junction for wiring from the battery charger circuits and from the ACR unit. Periodically check wires for secure fastening.

6. Battery switch (rear view). See earlier information for additional details. Note the red boots on the rear of the battery switch. Periodically check to ensure the boots cover the nuts securely and that the connections and nuts are tight. Disconnect the battery (ies) positive or + wires before tightening the battery switch nuts.

## DC (Direct Current) Helm Fuse Panel (Typical)

Lift up the starboard bow backrest to access the DC fuse panel. This panel protects many of the direct current devices along with their circuit wiring that are found on board your vessel. See the photo on this page.

Below we will acquaint the operator with the function of each fuse and information regarding the related component. These mini fuses can be purchased at most auto and marine supply houses. Never replace a fuse with a higher rated fuse to prevent possible fire or component damage. Always find the reason why the fuse “blew” before replacing it.

**NAV/ANC-** This 10 amp fuse protects the bow light located on front deck the deck mounted stern light. With the optional PowerTower an all around light is used verses the stern light.

**CPT/CAB LTS-** A 10 amp fuse protects the blue LED style blue cockpit lights which allows safer night maneuvering throughout the cockpit.

**DOCK LTS-** This 15 amp fuse protects the optional hull docking lights which are used for maneuvering in tight quarters at night. It is recommended that the docking lights be off when running above idle speeds at night since they might blind another boater from being able to see the bow light.

**GARMIN-** This 2.5 amp fuse protects the chartplotter(s) which show engine vitals along with GPS information.

**U/WTR LTS** The 10 amp fuse protects the stern mounted underwater lights.

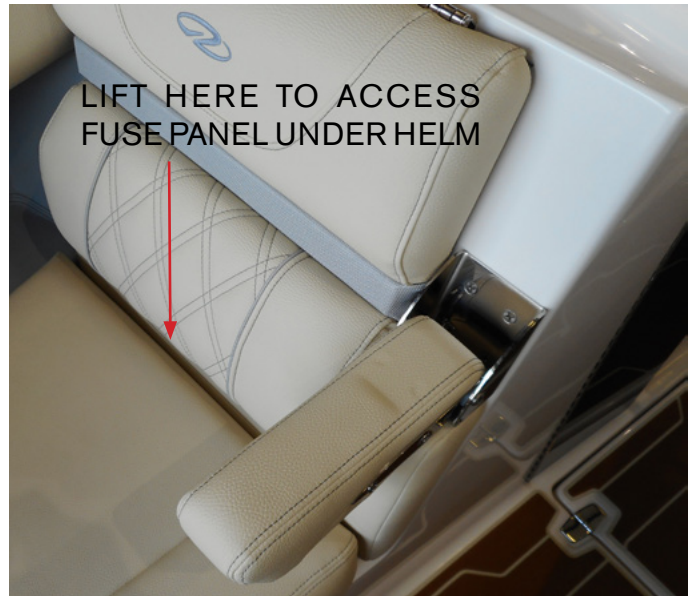

## DC (Direct Current) Helm Fuse Panel (CONT)

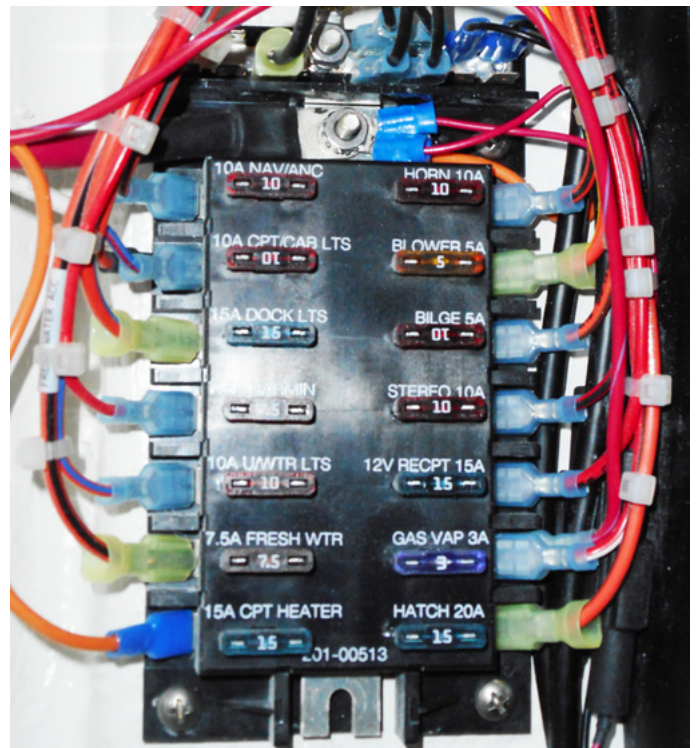

TYPICAL HELM DC FUSE PANEL

**FRESH WATER-** This 7.5 amp fuse protects the fresh water pressure pump and its wiring circuit. The pump is responsible for supplying potable water to the head faucet and transom shower if installed.

CPT HEATER- This 15 amp fuse protects the cockpit heater which is available on select surf models.

BLOWER- This 5 amp fuse protects the ventilation blower. This powered system removes any fumes and bilge air and provides an exit to the atmosphere through ducting located in the lower third of the bilge. Check these 4" black hoses periodically for their condition and fastening of hardware.

**Read and understand the warning label below.**

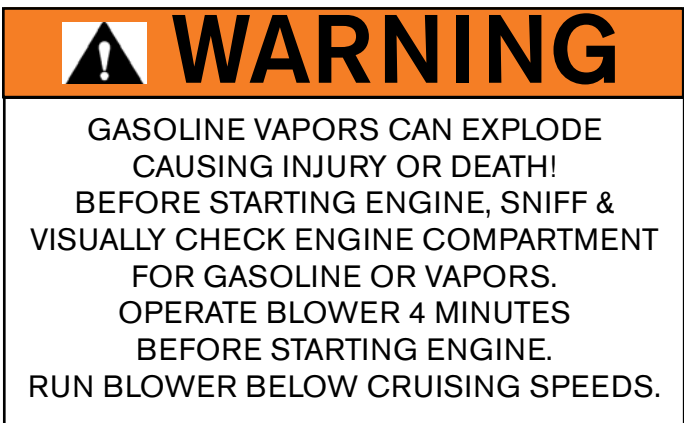

BILGE- This fuse protects the bilge pump and its circuit wiring located in the bilge. This pump features a dash switch automatic center position. Remember that your vessels bilge pump system with the automatic position is "on" even with the main battery switch turned off at the battery management panel.

STEREO- This 10 amp fuse protects the Fusion stereo circuit. Note that if stereo performance and lighting package is ordered there are additional fuses located in the system protecting the amplifier unit.

12 VOLT RECPT- This 15 amp fuse protects the 12 volt receptacles on the vessel. These can be used to power accessories or with the correct adapters to charge phones and tablets.

GAS VAP- This fuse position is not currently being used.

HATCH- This fuse position is not currently being used. With that being said the operator could use this one for protecting an after market accessory. Always ensure your fuse amperage allows the component a safety margin.



## Gasoline Fuel System

In this section, a typical EPA approved domestic gasoline fuel system is introduced. The fuel system includes the fuel tank, fuel feed lines, fill and vent fittings along with fuel filters, emission devices, natural and powered ventilation systems.

Gasoline today is processed in a different manner than it was a few years ago. As a result it has become more unstable and the product shelf life has been shortened.

Stern drive engines in this size range normally utilize a metal fuel tank. A special EPA approved low permeability hose system is used as required to supply the engine including fill, vent and feed hose. Read and understand the stern drive engine owner's manual fuel section and safety information before attempting to use the vessel.

*Note that due to a possible fire or explosion danger never store flammable liquids and/or portable fuel tanks in any storage compartment aboard the vessel.*

### Gasoline Specifications/Octane Ratings:

Gasoline Requirements- Use premium non-leaded gasoline with the following minimum octane rating for stern drive engines:

- **Minimum pump octane number is 89.**

The use of leaded fuels will damage the catalyts and must not be used with catalytic converters.

Gasoline in the United States and other areas is blended with 10% ethanol and is known as E-10 at the pumps. Marine engines used in your Regal boat shall be operated with premium unleaded

gasoline blended with no more than 10% ethanol and that meets the minimum 89 octane specification.

*Do not use ethanol blends greater than 10% such as a newer blend for select motor vehicles called E-15. Your marine engine may be damaged by more than 10% ethanol. A loss of performance may occur and the engine will not be covered by the engine manufacturer's warranty.*

Refer to your stern drive engine manufacturer's operator's manual for additional information regarding fuel information for your engine model.

As an option contact your engine manufacturer's hot line or text on web with fuel related questions. Also, additional fuel system information may be as close as your Regal dealer. Your Regal dealer has special training on the propulsion and Regal vessel systems.

### Fire port



Stern drives feature a fire port located close to the engine hatch. If a sump fire is suspected a plastic plate built into the port enables you to visually inspect the engine compartment without opening it and adding oxygen to the fire. In a fire emergency break the fire port plastic plate with the portable fire extinguisher nozzle, place the fire extinguisher position as vertically as possible in the port and pull the pin on the extinguisher to discharge the contents. Do not open the engine hatch until the fire is out and metal parts are cooled down.

The preferred portable extinguisher is a clean agent type such as the Halotron 1 as it removes the oxygen from the area which a fire needs to exist and grow. Look for a portable that is EPA approved and with no residue after use.

## Typical EPA Fuel System

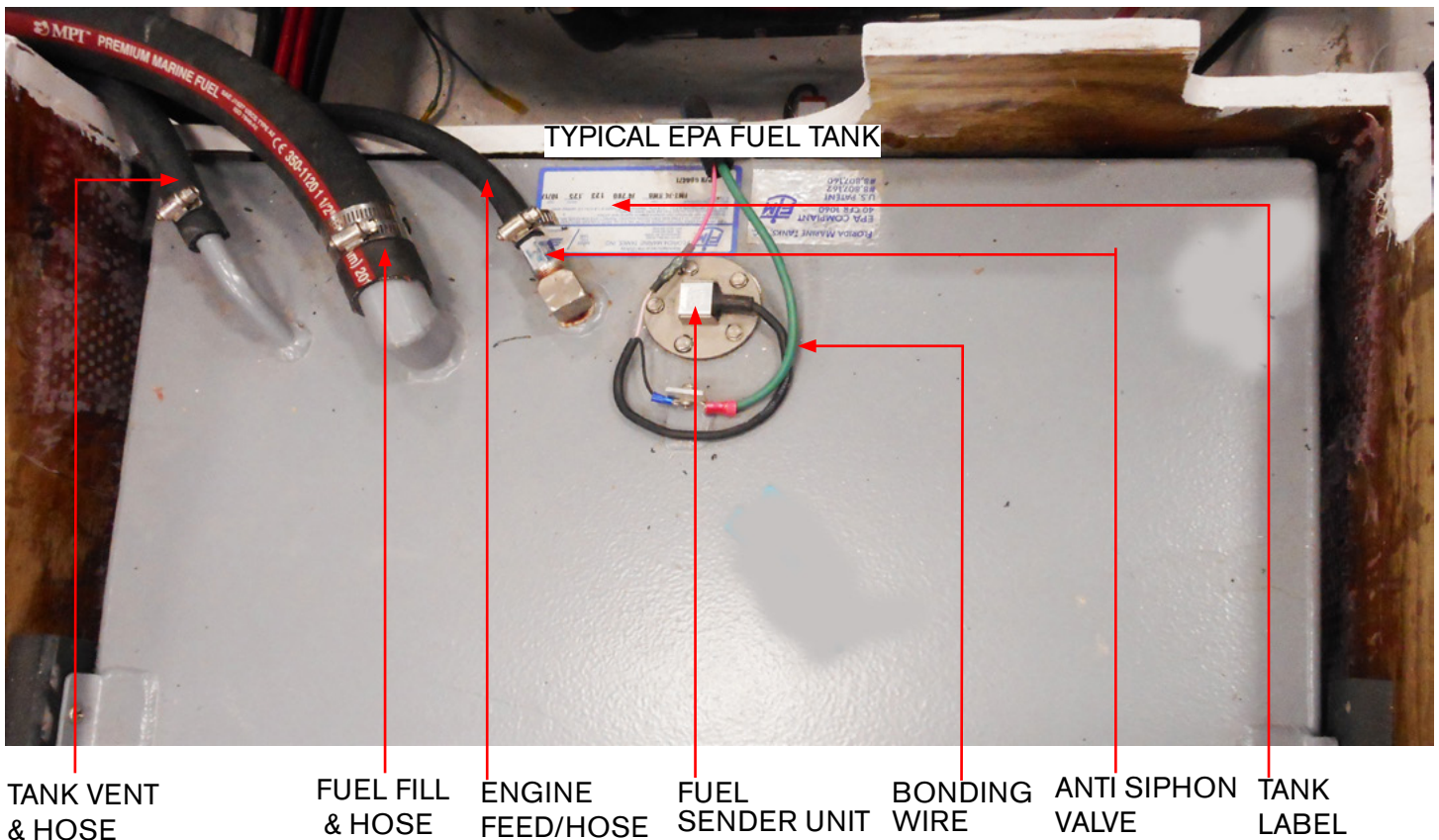

### Typical Fuel Tank

Vessels manufactured for *domestic* use are now required to be outfitted with an EPA compliant fuel system using an aluminum tank that must pass a battery of tests. This system uses special valves and baffles located inside the fuel tank along with special hoses marked for low permeability. Also, there is a carbon canister in-line with the vent hose which functions much like the one in an automobile by filtering gas fumes. The carbon canister rarely needs to be replaced and is not a serviceable item.

These tanks are tested and inspected along with the complete fuel system several times for safety requirements and quality by the fuel tank supplier, in house personnel, and independent inspections by National Marine Manufacturers Association personnel.

### Fuel Fill Fitting

The fuel fill fitting is labeled “gas” and in addition displays the international symbol (See the next page). When fueling the boat keep the fill nozzle in contact with the fuel fill pipe since it decreases effects of static electricity. Always use the recommended fuel octane rating as specified in your engine owner’s manual.

*Extinguish all flame producing agents before fueling!*

## WARNING

**AVOID SERIOUS INJURY OR DEATH FROM FIRE OR EXPLOSION, RESULTING FROM LEAKING FUEL. INSPECT SYSTEM FOR LEAKS AT LEAST ONCE A YEAR.**

## Fuel Vent Fitting - Typical



COMBO FUEL FILL/  
INTERNAL VENT

Currently, domestic EPA compliant fuel tanks vent fumes back into the fuel tank system. While the tank is filled, air displaced by the incoming fuel is vented through the fuel system charcoal canister.

Your vessel uses a combo type (internal vented) fuel fill. Both the fuel fill and vent occupy the same cavity under a protective cover. If fuel overflows through the vent the design forces it back into the fuel fill hose and tank. Be sure to tighten the fuel fill cap completely to prevent water and debris from entering the fill system.

A seasoned skipper will hear a distinct sound as the tank nears the “top out” or full mode and may see fuel overflowing back into the fuel hose through the vent hole in the fill fitting. On select vessels not using an EPA fuel system there may be a separate vent fitting on the hull side. Periodically check this vent screen for debris and insect activity.

# NOTICE

DO NOT OVERFILL THE FUEL TANK!  
THIS HELPS AVOID ANY OVERBOARD  
SPILLS WHICH MAY HARM THE  
ENVIRONMENT!

## Anti-Siphon Valve

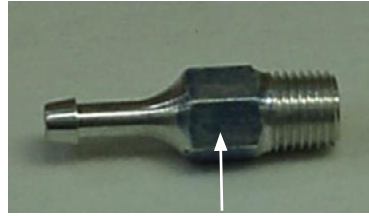

INTERNAL BALL/SPRING

The gasoline fuel tank feed line that runs from the fuel tank to an engine fuel component uses an anti-siphon valve.

The valve is threaded into the fuel tank fitting at the feed line. The valve is pulled off its seat by fuel pump pressure as the engine is cranking or running. There is a ball and spring assembly inside the valve that is activated by fuel pump impulses. It allows a one-way fuel roadway to the engine fuel system. It prevents fuel from siphoning out of the tank in the event of a fuel line rupture or damaged fuel feed hose. When the engine fuel components stop the fuel from cycling the spring forces the ball against the valve opening to prohibit fuel flow.

Never remove an anti-siphon valve as it is a fuel system safety component. Also, never remove the ball and spring from the valve assembly. The anti-siphon valve requires no normal maintenance. Symptoms indicating possible anti-siphon valve problems may be fuel starvation at intermediate or high rpm or in extreme cases an engine that will not start.

Contact your Regal dealer for further information.

 <b>WARNING</b>
PREVENT INJURY OR DEATH! READ AND UNDERSTAND THE PROPULSION OWNER'S MANUAL BEFORE ATTEMPTING TO OPERATE THE VESSEL.

### Fuel Filters

Spin on fuel filters found on stern drive engines function to remove moisture and impurities from the fuel supply before traveling through the engine fuel system. They should be serviced periodically per the stern drive engine manufacturer's instructions. It is a good idea to keep extra fuel filters on board along with a strap style filter wrench, catch container and clean rags for emergencies. Never use automotive style fuel filters on your vessel. Dispose of all fuel residue materials in an environmentally safe fashion.

These filters are available on-line, through marinas, retail marine outlets, or can be ordered via your closest Regal dealer.

 <b>WARNING</b>
PREVENT INJURY OR DEATH! FUEL VAPORS ARE A FIRE AND EXPLOSION HAZARD. DO NOT STORE FUELS, FLAMMABLE LIQUIDS OR PORTABLE FUEL TANKS ON BOARD!

Read and understand the label above regarding the storage of flammables on board the vessel. Also, do not store auxiliary portable fuel tanks on board the vessel since these portable tanks can emit vapors into the atmosphere through their vent.



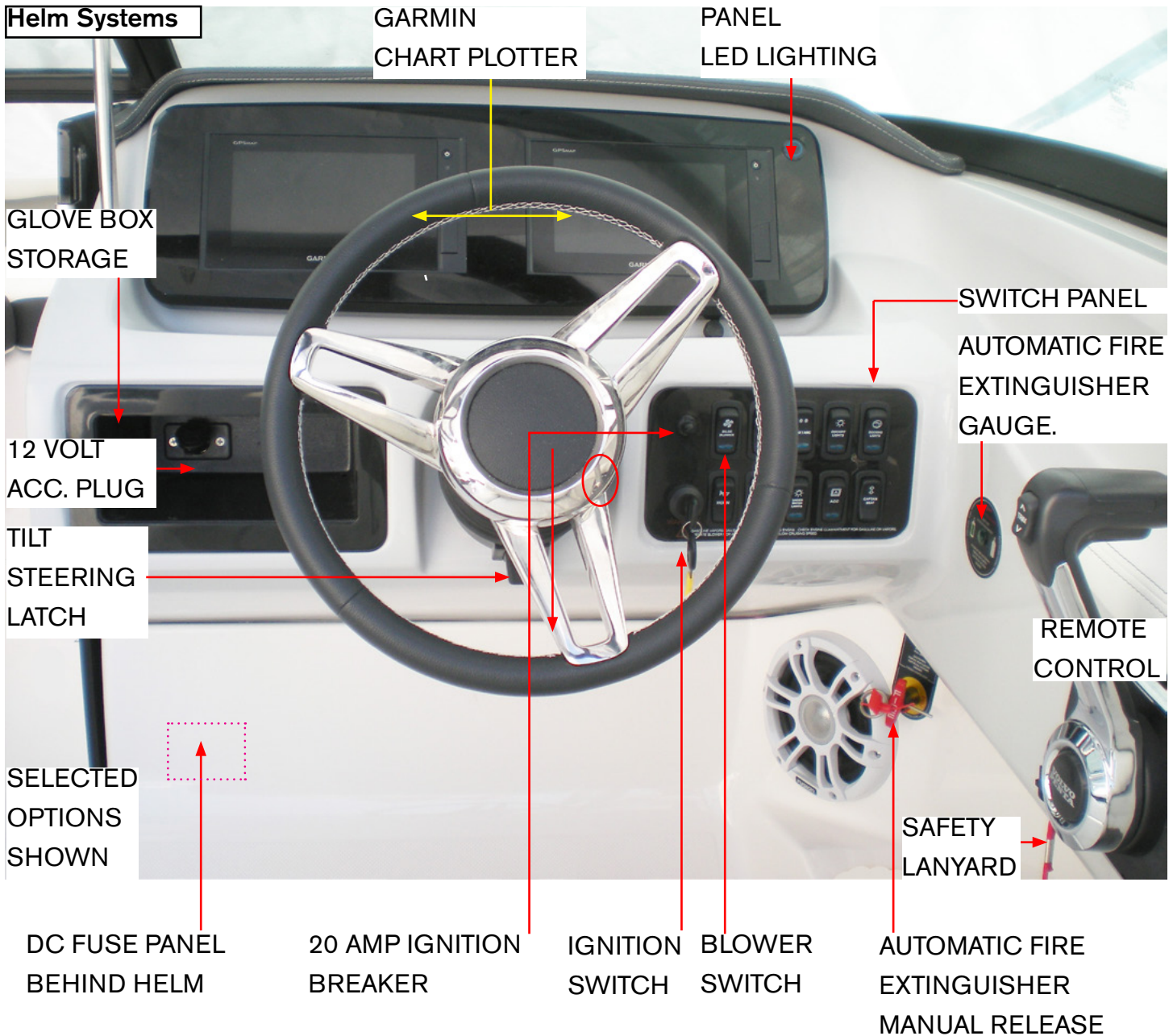

Helm Overview- (Typical)

The helm station is equipped with the ability to monitor engine functions through a Garmin chart plotter (Dual plotter option shown). Close observation of the digital display is recommended throughout the trip as you can split the screen to accommodate GPS functions along with monitoring basic engine systems including fuel usage and hours for maintenance cycles. This works in addition to the engine manufacturer's information panel system.

Obviously with the dual chart plotter option another whole dimension of information monitoring is achievable. Note that with the battery switches in the "off" position, there is no power to the helm and the ignition switch will not function.

All electrical features are protected by the main battery management panel located in the sump. Refer to earlier pages in this chapter for additional information. Note to read and understand the blower operation information on the bottom of the switch panel shown above before starting engine.

## Helm Switch Panel



Typical Switch Panel Shown

The helm switch panel controls various vessel electrical components. The main battery switch must be activated for most of the switch functions to work except for the automatic side of the aft bilge pump. When a particular component is activated the blue icon portion of the switch lights up. This feature is great for night cruising, too. Below is a brief description of each switch. *Note that select switches may represent optional equipment that is not installed on your vessel.*

### Bilge Blower

One of the most important components on the stern drive boat is the bilge blower. The blower switch controls the powered ventilation system (blower). Read and understand the following warning label.

 **WARNING**

GASOLINE VAPORS CAN EXPLODE  
CAUSING INJURY OR DEATH!  
BEFORE STARTING ENGINE, SNIFF &  
VISUALLY CHECK ENGINE COMPARTMENT  
FOR GASOLINE OR VAPORS.  
OPERATE BLOWER 4 MINUTES  
BEFORE STARTING ENGINE.  
RUN BLOWER BELOW CRUISING SPEEDS.



Typical Ventilation Blower with Hose

The powered ventilation system (blower) aids in removing any gas fumes from the engine compartment and any joined compartments. Also, the blower removes any polluted air. *Never obstruct or modify ventilation system!*

Periodically check the black “4” hoses connected to the blower for tightness. In addition, ensure there are no holes or tears in the hose since efficiency may be compromised. Also, make sure the attached hose ends extends into the lower third of the bilge. This is important since gasoline fumes are heavier than air and tend to gather in the lower bilge.

When the blower is activated any fumes will be drawn up the hose and dispersed overboard through the aft vent system.

*Note that there are other black hoses attached to the aft vents that may only extend a short distance from the vent not like the longer extending exhaust hoses. These shorter hoses bring fresh air into the engine compartment and allow the engine to “breathe” so it can run more efficiently. They comprise the “natural” ventilation system.*

## Bilge

This switch controls the bilge pump which is located below the front of the engine at the bilge floor. This bilge pump removes any accumulated water from the bilge.

*Note that with the bilge switch in the center position the pump circuit assumes an "automatic" position and will operate even with the battery switch in "off" position with the vessel unattended. This is a safety feature.*

Periodically check the bilge pump grate for debris that could effect the pumping efficiency. Also, never manually run the pump dry for extended periods as the impeller may develop premature wear.

## Nav/Anc

This on/off/on switch energizes the center bow red/green navigation light and all-around light as a standard configuration as the top portion of the switch is pressed. This is the position for nighttime headway navigation. The lower portion of the switch will energize the all-around light on the deck for anchored use only or vessels with PowerTower or hard top will have the all around light on top of the tower or hard top.

## Cockpit Lights

This switch controls the blue LED lighting which is normally found on vertical surfaces to aid in nighttime cockpit activity. They are especially useful to light stairways, deck walkways, and swim platforms. LED lights are durable, cool to the touch and draw only a small amount of amperage.

## Docking Lights

This switch controls the optional hull docking lights. These lights are valuable for maneuvering around docks and tight waterways at night such as you might find at marinas and locks. Do not use these lights for navigation as other vessel may not be able to see your combination bow light especially for head on and crossing situations.

## Horn

This momentary switch controls the electric horn located at the starboard bow area. Make sure the horn is tested before each outing as it can be valuable in navigation situations and can be used for bridge communications. Normally there is an adjustment screw on the horn top to alter the tone. Periodically inspect the horn hardware for tightness and polish the horn grill.

## Tower

This switch controls the forward or aft tower movement. When the "up" switch position is pressed the PowerTower moves to the forward position which is useful for bridge navigation and storage opportunities.

When the "down" switch position is pressed the PowerTower moves to a vertical or run position. The vessel operator shall read and understand this following label:

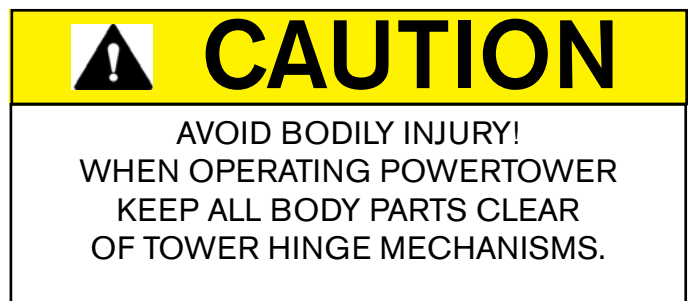



## Under Water Lights

This switch controls the hull mounted underwater lights. If installed these blue or white LED lights illuminate the water around the aft, sides, and transom areas. It is recommended that these lights not be activated at night with the vessel making headway.

## Fresh Water

This switch energizes the on board potable fresh water system available on select models. It permits the water pump to draw fresh water from the potable water tank to any faucets or showers/ wash downs mounted aboard. *Note that the switch cover is still present even though it may not have the fresh water option.*

## Captain Seat

This switch activates the movement of the captain seat for more comfortable positioning and visibility enhancement. Press the upper portion of the switch to slide the seat forward. Press the lower portion of the switch to move the seat aft for additional leg room.

## Entertainment



### Fusion Stereo

#### Introduction

Your Fusion stereo is part of the Apollo family which makes it simple to customize your audio entertainment and speakers for superior sound quality in any area of your vessel. A selection of Fusion technology features are found below. **Refer to your Fusion owner's manual for complete operating instructions.**

The Fusion stereo unit installed in your vessel is designed and engineered for the harsh marine environment. Head units are globally IPX5 rated against water ingress. When you leave your boat after a cruise weekend you can count on all selections being saved through a stereo memory system featured on your vessel, even with the main battery switch turned off.

Regal offers durable marine speakers and optional speaker LED lighting for ambiance.

The unit offers independent control of your audio entertainment including balance, sub woofer, and volume level from multiple audio zones as part of the optional stereo performance package.

The stereo features Fusion-Link™ an entertainment integration process which permits **Fusion to be displayed and controlled on your Garmin chart plotter using a NMEA 2000 network which communicates with each component.**

## Features

**Digital Sound Processing (DSP)-** A technically superior listening experience using precisely calculated loudness curves optimized for the human ear ensure quality, full range audio at every volume level with distortion controls in place.

**Party Bus\*-** A system of additional enabled stereos that gives you the option of joining Party Mode and play the same synced audio source through your entire vessel. You can go into Personal Mode and listen to available audio sources from your stereo in area of your choice without disrupting Party Mode in other sectors of the boat.

*\*Note that PartyBus and over the air software updates require the integration of an external network router or Apollo RA 770 stereo which may be available on line or from a Fusion dealer.*





**Over-The-Air Software Updates-** Available from your smartphone or compatible device through the free Fusion-Link app.



**More Source Options-** Bluetooth, UPnP, Optical Audio, advanced SiriusXM features and DAB + radio available, AM/FM radio, AUX and USB connections are readily available.

**Advanced SiriusXM features (USA Only):** Includes Instant Replay, TuneStart, TuneMix, SportFlash, along with Artist, Song and Game Alerts.

*Note that a SiriusXM subscription and tuner are required to access SiriusXM satellite radio (available in USA only) DAB + radio requires the addition of an MS-DAB100A module (sold separately).*

## Controls

Button	Function
Dial	<ul style="list-style-type: none"> <li>Turn to adjust the volume.               <ul style="list-style-type: none"> <li>When adjusting the volume, press to switch between zones.</li> <li>When adjusting the volume, press and hold for at least one second to adjust the subwoofer levels.</li> </ul> </li> <li>Turn to move through the menus or adjust a setting.</li> <li>When in a menu, press to select the highlighted option.</li> <li>On a screen with tabs, press and hold for at least one second to open the other tab, such as the PARTYBUS tab.</li> </ul>
	<ul style="list-style-type: none"> <li>Press to turn on the stereo.</li> <li>Press to mute and un-mute the audio.</li> <li>Press and hold to turn off the stereo.</li> </ul>
	<ul style="list-style-type: none"> <li>Press to open the menu.</li> <li>Press to return to the previous screen from the menu.</li> <li>Press and hold to exit the menu.</li> </ul>
	<ul style="list-style-type: none"> <li>Press to change the source.</li> <li>Press and hold to open the PARTYBUS menu.</li> </ul>
	<ul style="list-style-type: none"> <li>Press to skip to the beginning of the track or to the previous track, when using an applicable source.</li> <li>Press and hold to rewind the track, when using an applicable source.</li> <li>AM, FM, or SiriusXM (in Live Mode) source:               <ul style="list-style-type: none"> <li>Press to tune to the previous station or preset.</li> <li>Press and hold for faster tuning (manual mode only).</li> </ul> </li> <li>SiriusXM (in Replay Mode) source:               <ul style="list-style-type: none"> <li>Press to skip to the previous track.</li> <li>Press and hold to rewind the current track.</li> </ul> </li> <li>DAB source:               <ul style="list-style-type: none"> <li>Press to return to the previous DAB station in the ensemble. When you reach the beginning of the current ensemble, the stereo automatically changes to the last available station in the previous ensemble.</li> <li>Press and hold to change the ensemble.</li> </ul> </li> </ul>

	<ul style="list-style-type: none"> <li>Press to pause or resume media playback.</li> <li>AM/FM:               <ul style="list-style-type: none"> <li>Press to cycle through the tuning modes (auto, manual, and presets).</li> <li>Press and hold to save the selected station as a preset.</li> </ul> </li> <li>SiriusXM source:               <ul style="list-style-type: none"> <li>Press and hold to switch between Replay Mode and Live Mode.</li> <li>In Live Mode, press to cycle through the tuning modes (manual, category, and presets).</li> <li>In Replay Mode, press to pause and play.</li> </ul> </li> <li>DAB source: press to scan for DAB stations.</li> </ul>
	<ul style="list-style-type: none"> <li>Press to skip to the next track, when using an applicable source.</li> <li>Press and hold to fast-forward the track, when using an applicable source.</li> <li>AM, FM, or SiriusXM (in Live Mode) source:               <ul style="list-style-type: none"> <li>Press to tune to the next station or preset.</li> <li>Press and hold for faster tuning (manual mode only).</li> </ul> </li> <li>SiriusXM (in Replay Mode) source:               <ul style="list-style-type: none"> <li>Press to skip to the next track, if applicable.</li> <li>Press and hold to fast-forward the current track, if applicable.</li> </ul> </li> <li>DAB source:               <ul style="list-style-type: none"> <li>Press to advance to the next DAB station in the ensemble. When you reach the end of the current ensemble, the stereo automatically changes to the first available station in the next ensemble.</li> <li>Press and hold to change the ensemble.</li> </ul> </li> </ul>

### Stereo Screen

The information displayed on the screen varies depending on the source selected. This example shows the device playing a track on a device connected using Bluetooth® wireless technology.



①	Source
②	Network status ( <i>Network Status Icons</i> , page 11)
③	Album art (if available from a compatible source)
④	Track details
⑤	Elapsed time, track duration, and the current track number out of the total number of tracks in the playlist (if available)

### Selecting a Source

- 1 Select .
- 2 Turn the dial to highlight a source.
- 3 Press the dial to select the source.

**NOTE:** Some sources appear in the source selection screen when they are not connected to the stereo. The USB icon is red when a USB device or cable is not connected.

Activate the Garmin plotter screen to control the stereo display functions and features. In addition the system can be controlled by activating the Apollo unit at the passenger side of the cockpit.

More product information along with operation manuals can be downloaded at the following web address:

[www.fusionentertainment.com/marine](http://www.fusionentertainment.com/marine)

See the troubleshooting chapter for system assistance or contact Fusion web-site.

## NMEA 2000 Network

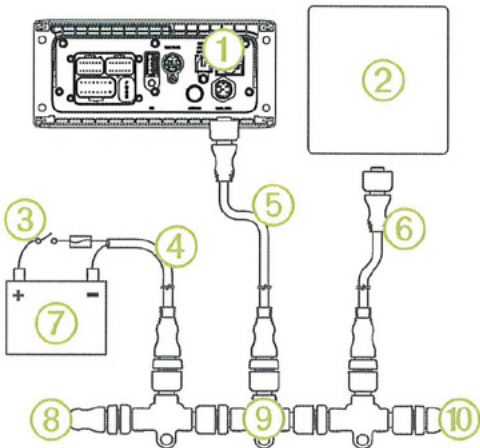

①	Stereo
②	Supported chartplotter MFD or compatible FUSION NMEA 2000 remote control
③	In-line switch
④	NMEA 2000 power cable
⑤	NMEA 2000 drop cable from the stereo, up to 6 m (20 ft.)
⑥	NMEA 2000 drop cable from the chartplotter MFD or compatible FUSION NMEA 2000 remote control
⑦	9 to 16 Vdc power supply
⑧	NMEA 2000 terminator or backbone cable
⑨	NMEA 2000 T-connector
⑩	NMEA 2000 terminator or backbone cable

Also, check for proper system DC grounding. Ensure that system voltage is at 9 or higher as low battery voltage will effect NMEA 2000 operation.

Above is a typical NMEA 2000 network as used with the Apollo Fusion series entertainment package. Note the backbone to which all individual components including the Garmin plotter are connected to for communication purposes. The system uses 12 DC power and is protected by a fuse located under the dash inside the yellow sleeve connector. Note the terminator plugs on each end of the backbone. They must be intact for the backbone to operate efficiently.

Should the system stop working check the fuse, all backbone connections and the terminators for missing caps.



# Chapter 5

## Engine & Controls

### LS2 Stern Drive Engines & Systems

#### Engine Checklist Before Each Outing

Every engine option may require different checks before each use, but a general **stern drive** engine checklist is included here as a guide.

- Check crankcase engine and stern drive oil levels.
- Check power steering fluid.
- Check power trim fluid/trim tab levels.

#### At Helm/Deck

- Check power trim for operation.
- Check control lever for operational defects. Check the clip and safety lanyard for functionality.
- Check any gauges for accuracy.
- Check fuel level and ensure the level is sufficient for the trip with a 1/3 reserve.

#### Engine Cooling System

Your typical engine normally utilizes a raw water system for cooling the engine with intakes at the



Typical Engine Overview Shown

gear case. It is important that this system continues to run unobstructed at all times to avoid hazardous situations and to ensure a safe voyage.

Raw water is drawn up into the vertical drive shaft housing through pick-up feeds above the gear case vicinity into a water pump and impeller and then into the engine itself. Water passes through a thermostat which controls how much water circulates through the engine. The cool water absorbs heat produced by the engine, before being circulated to the coolant exhaust system.

#### Impeller/ Water Pump

Periodically, the coolant system impeller and water pump should be inspected for debris, damage or excessive wear due to wear, water chemistry such as mineral and/or silt conditions. Damaged parts will affect the system's ability to function, and may cause engine overheating or damage. Contact your closest Regal dealer for more information and maintenance schedules affecting the engine coolant system.

## Thermostat

If the temperature gauge starts yielding abnormal readings, it may become necessary to look at or replace the thermostat after determining whether it is functioning properly. The thermostat reads the temperature of coolant and determines whether to open or close a valve to allow warm sea water to pass into the exhaust manifold. The thermostat may recirculate hot coolant for the purposes of reaching standard operating temperatures. If standard operating temperatures have been reached, the thermostat will open a valve and allow hot raw water to exit through the exhaust manifold. For more information read your engine manual or contact the closest Regal dealer. Dealers have the necessary knowledge and tools to troubleshoot any engine related problems.

 <b>WARNING</b>
PREVENT INJURY DUE TO HOT SURFACE! AVOID TOUCHING THE THERMOSTAT OR ITS COMPONENTS WHILE THE ENGINE IS HOT.

 <b>CAUTION</b>
TO PREVENT ENGINE DAMAGE DUE TO OVERHEATING AVOID RUNNING THE ENGINE WITHOUT A FUNCTIONING THERMOSTAT.

 <b>CAUTION</b>
AVOID ENGINE DAMAGE OR FAILURE! DISCONTINUE ENGINE OPERATION AFTER AN ALARM HAS SOUNDED. ADDRESS MALFUNCTION BEFORE RESTARTING ENGINE.

## Engine Electrical System

Your engine utilizes a great deal of electronic equipment. Some equipment sends signals between the engine and the Garmin, while other systems set off alarms, and still others are used by the engine to generate a spark and ignite the fuel. The battery switch controls electrical power distribution to the boat systems.

To regularly maintain your DC electrical system, inspect battery condition before each trip. Test all gauges and control equipment prior to departure, and replace as necessary. Spark plugs should be replaced according to your engine owner's manual maintenance schedule.

### Gauge Electrical Signals

Your stern drive engine transmits signals through electrical harnesses to different components through the use of NMEA 2000 connections and a "backbone system". A Garmin plotter displays the engine functions. The fuel gauge and depth sounder use stand alone technology to display readings. Also, idiot lights are display tolerances that are classified as being abnormal.

### Alarms

If a malfunction with your engine occurs, the Garmin plotter alerts the skipper of a problem. Common engine problems include overheating, low oil pressure, or a miscommunication with equipment. Learn the alarm systems that apply to your engine by consulting your engine owner's manual. Engine manufacturer's feature their own engine display screen which may display rpm, engine hours, coolant temperatures and use alarms.



## Garmin Engine Monitoring Display



Typical Display Shown

A Garmin chart plotter may be installed on your vessel. The unit displays many GPS features along with the ability to monitor engine system functions including engine revolutions per minute (rpm's), GPS speed, voltage, fuel flow rate, trim, and temperature along with tracking engine hours. Fusion uses its own display screen on the chart plotter for audio controls on the vessel.

Note that the Garmin and Fusion circuitry use individual DC sources to power up the system. The key switch does not power up these 2 systems.

1. To power up the Garmin GPS press the "on" button located at the upper chart plotter display.
2. The function AV/Gauges,Controls will appear as one of the choice boxes. Press the box. Another screen with engine will appear.
3. Press the engine box and the engine gauge displays will appear (oil pressure is engine code driven only).

For more information refer to the Garmin manual.

## Spark Plugs

The spark plugs are components that help make ignition occur. As electrical potential builds on one side of the gap based upon the energy distributed by the ignition system, the potential eventually grows large enough to cause the electric current to jump the gap on the spark plug. This spark is what ignites the compressed fuel generating a controlled explosion that will power the piston down and deliver power to the drive shaft.

## Alternator

Under normal circumstances, the starter battery would wear down after being used so often to generate a spark for the engine. This isn't an ideal setup because a strong battery is needed for continual operation. A weak battery does no good out on the water. The alternator recharges the batteries while the engines are running.

However, in an effort to conserve battery life, the battery switch should still be turned off after every trip and turned on at the start of every trip. This limits the drain on the battery while the boat is not in use. As optional equipment a 10 amp battery charging system charges batteries when the shore cord is connected to the vessel 3 prong grounded plug which must be connected to a GFCI outlet. Read and understand the following label!

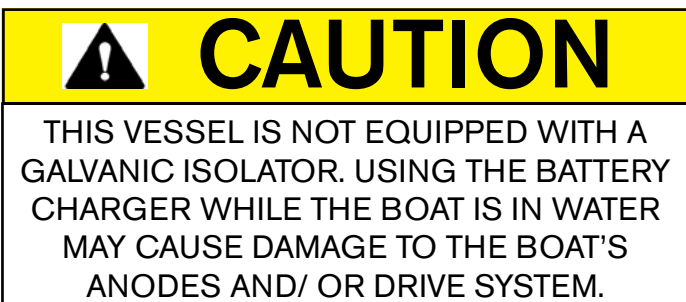

## Fuses

Your engine also comes equipped with fuses that will burn out or “blow” when engine components attempt to draw more power than the piece of equipment or wiring can handle. When the fuse blows, it breaks the circuit, and electricity stops flowing. Before replacing the fuse, investigate the cause of the problem, and why the equipment was overworked. Your engine uses a helm mounted fuse box which is accessible by lifting the starboard bow backrest while other engines feature in-line fuses, while still others feature a mixture of both. Refer to your engine owner's manual for complete details on your electrical system and the location of any engine mounted over current protection.

## Engine Exhaust System

Your engine expels the by-products of the engine operation through an exhaust system, just like automobiles do. In boats however, this exhaust system mixes the debris left over after the power stroke of the engine with the hot water that is expelled after cooling the engine.

Basically the exhaust flows through the engine before expelling the exhaust through the vertical drive housing either just above the propeller, or through the prop shaft.

## Engine Fuel System

Refer to the system chapter of this manual for fuel system specifics. Be sure to read and understand the warnings on the next page.



## WARNING

USE OF ALCOHOL ENHANCED FUEL, OR ANY FUEL OTHER THAN GASOLINE CAN LEAD TO DETERIORATION OF THE FUEL SYSTEM COMPONENTS. THIS CAN RESULT IN FIRE AND POSSIBLE EXPLOSION.



## WARNING

GASOLINE VAPORS CAN EXPLODE!  
BEFORE STARTING ENGINE  
CHECK BILGE COMPARTMENTS  
FOR GASOLINE LEAKS OR VAPORS.



## WARNING

PREVENT INJURY OR DEATH  
DUE TO FIRE OR EXPLOSION!  
RUN BLOWER AT LEAST 4  
MINUTES BEFORE STARTING ENGINE.

### Engine Lubrication System

Whenever two components rub together, friction causes wear on both components. To minimize the wear on your engine, a lubrication system has been put in place to help components slide next to each other easier. This is particularly important within the inner workings of an engine. It is important to ensure your lubrication system is working properly at all times.

Your Regal utilizes lubrication and fluids that need regular check ups. Refer to your engine owner's manual for specific details regarding the proper maintenance of the lubrication system.

*Note that your engine uses other lubricants in addition to engine oil such as power trim fluid and gear lubricants to reduce wear on moving components. These fluids should be checked according to the recommended maintenance procedures determined by the engine manufacturer.*

### Engine Oil

The purpose of engine oil is to lubricate the internal components of the engine and ensure parts that regularly move against each other have reduced friction to lessen wear and noise between components. An oil filter keeps metal particles and water out of the engine's interior.

Stern drive engines performing on regular oil should have the oil drained and replaced after the first 20 hours of operation or 3 months, and every 100 hours or at 1 year intervals thereafter.

### Stern Drive Oil

Stern drive oil keeps all the mechanical components of the prop shaft gear assembly functioning optimally. It reduces friction in the gear case as the gears revolve. Sometimes gear case oil is called gear lubricant. Gear case oil should be inspected periodically according to factory maintenance schedules. Use engine manufacturer's recommended oil.

### Power Trim Fluid

Power trim fluid allows your out drive to trim up or down. This is particularly useful when trying to get your boat to plane.

Power trim fluid is used in hydraulic rams that maneuver the stern drive unit. Power trim fluid should be checked regularly in the reservoir which is located in the bilge.

## Propeller System



Regal has carefully tested and chosen the propellers to give your vessel the best possible performance based on the engine and propulsion package you choose. We have allowed for the additional weight in equipment that might be added to the boat. It is a good idea to carry a spare set of propellers and hand tools onboard in order to handle emergency propeller changes.

Marine propellers may display the following information:

1. Propeller pitch shown by inches.
2. Propeller type (L for left or R for right).
3. Propeller diameter in inches

Refer to the engine manual for propeller removal and installation procedures, as the application is unique to the manufacturer. Call a marine professional or your Regal dealer for to order a spare propeller set.

## Propeller Checklist

At least twice a year, check the propeller for:

- Loose, missing, or corroded hardware.
- Nicks, dings, or missing propeller material
- Bent propeller blades.
- Objects wrapped around the prop (fish line)
- Decomposing propeller blades (electrolysis symptom).
- If equipped, check the propeller rubber hub for slippage

Contact a propeller shop or your closest Regal dealer if any of the above symptoms exist. They have purchased special equipment to refurbish both stainless steel and aluminum propellers.

## Starting Engine

### Before Starting Engine

*Note that it is important that you read and understand the engine operator's manual carefully and become completely familiar with the operation as well as required maintenance procedures on the engine and related propulsion systems.*

Before starting the engine check the guidelines below:

1. Open the engine hatch and sniff for fuel smells and visually check for fuel leaks. If gasoline vapors are sensed or leaks seen be sure to determine the cause and repair the source **before starting the engine**. If you can not locate a fuel leak contact a marine professional immediately or your closest Regal dealer.

1 A. Always run the bilge blower at least 4 minutes before attempting to start the engine. Continue to run the blower after the engine starts below cruising speeds.

2. Remove any loose canvas and store in a dry location.

3. Shut and secure all portholes and doors.

4. Make sure the swim ladder is secured in its folded position and that the cover if installed is in place.

5. Check fuel supply levels. Use the fuel "1/3" rule.

6. Turn battery switch to the "on" position at the battery panel.

7. Activate the VHF if installed and listen for the latest weather conditions along with performing a radio check.

8. Activate the plotter and check its function, set your cruise, and monitor engine read-outs once the engine has started.



Check to ensure that all ventilation duct grills are clear of foreign objects. The

natural and powered ducts provide a continual air supply to the engine compartment and evacuate any fumes along with warm air. Sometimes insects make nests in the vent ducts. Lift the aft cushion on both port and starboard sides to access the ventilation ducts/grilles.

### Starting Engine

After the preliminary checks are performed the engine is ready to start. Insert the ignition key into the ignition panel key switch hole. Note that the key switch shows three positions;



A) Straight Up= "Off"

B) 45 Degree Angle to Right= "Ignition" or "On"

C) Spring Loaded Furthest Right= "Start"



When you turn the key switch to the furthest right position you may feel a small resistance which is the spring loaded key switch position. This is normal.

Ensure that your remote control is in the idle neutral position before beginning the starter cranking process!

Crank the starter over until the engine starts. When the engine starts leave go of the key and it will spring back to the ignition or "on" position for normal running.

If the starter continues to crank and the engine does not start turn the key back to the "off" position and let the starter cool down between start attempts.

*Note to avoid possible starter damage do not crank over the starter more than 20 seconds on each start cycle.*

*Note that if a flooding condition should exist put the throttle in full throttle neutral gear position and crank the starter. If it does not start try it again in the same advanced neutral throttle position. When it starts return the throttle to the upright neutral idle position. If it does not start return to the neutral idle position and let it set a few minutes before re-cranking the starter. Never continuously pump the throttle.*

## After Starting

1. Allow the engines to idle for a short period as they warm up. Never race a cold engine!
2. Check the chart plotter and pay particular attention to volts, oil pressure and temperature display panel functions as they are key indicators of a proper performing engine. Also, check that no alarms are sounding, warning lights are flashing and no fault codes display on screens. See information display.
3. Open the engine compartment and listen to engine for unusual sounds.
4. Inspect the fuel, exhaust, and engine circulation system for leaks.
5. Visually check the entire sump (bilge) for any unusual conditions.
6. Visually check your passengers to ensure they are wearing the proper PFD, are sitting in a designated seat, boat load is balanced, and the operator has uninterrupted field of vision both forward and aft before shifting the remote control.
7. Make sure that all passengers have been informed on using the various seat hand holds should the sea conditions deteriorate.

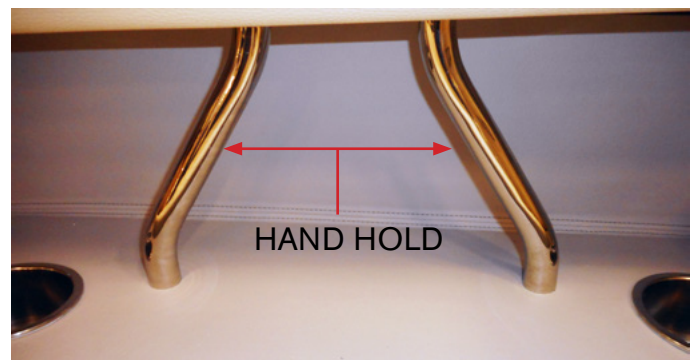





8. Selected vessels feature an information display panel as part of the engine related components. This helm display shows engine and operational

information, messages and alarms. A portion of the same engine information could be displayed through the chart plotter display.

The basic settings show:

- Engine speed
- Oil Pressure
- Coolant Temperature
- Battery Voltage

One of the features on the information panel is the fault display. If the system finds a fault, the word fault and the number of them are shown on the display. By pressing the OK button the panel will display all detected faults.

Navigating to the Settings menu. Press OK to bring up sub menus. Use the arrows to seek the information. For more detailed information refer to the engine operation manual.

*Note that it is recommended to use the display cover on the unit when not in use. The prolonged rays of the sun and high temperatures over time may damage the screen.*

## Corrosion Protection Systems

Your vessel's engine either Volvo or MerCruiser may be equipped with a corrosion protection system. The Volvo system is called the active corrosion protection system (ACPS) and the MerCruiser system is called a MerCathode system. Refer to your engine manual for more information. We will cover the basic ACPS system here.

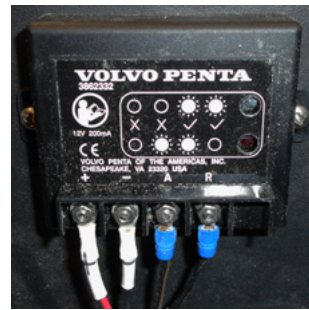

The ACPS works as an active anode and is programmed to reduce the galvanic corrosion in underwater stern drive parts. The system works along with the sacrificial drive

zinc anodes. Longer life for anodes is provided through the ACPS but periodic maintenance checks of anodes are still required. This system was designed to work only in salt water.

The system will not provide protection from stray currents emitted from a faulty AC power source on the dock, your boat, or other boats close to yours. The module is usually mounted aft of the engine. Red and green LED lights show system status.

1. Green LED only indicates the system is working.
2. Green and red LED's on, the system is working, but the system is drawing power.
3. Red LED only, the system has power but is not working (no protection).
4. No LED's, the system does not have power, and is not working (no protection).

## Remote Control

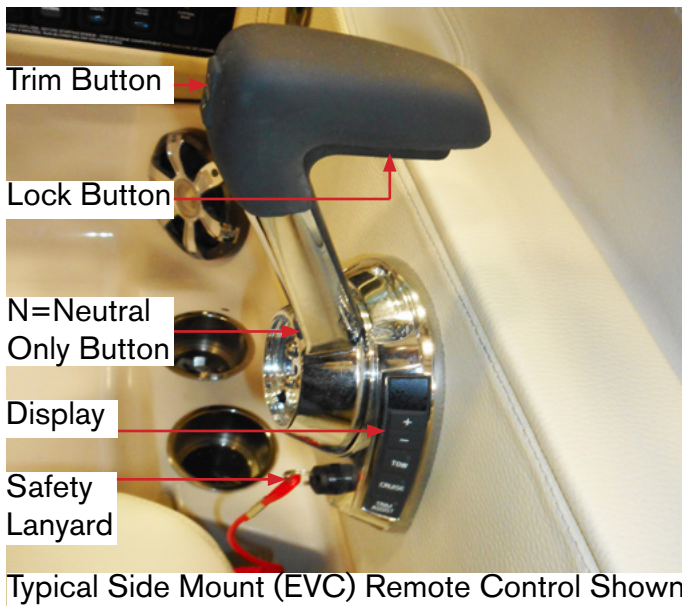

### Introduction

A majority of bow rider stern drive vessels use a single lever side mount binnacle control for shifting and throttle operations. The remote control handle controls forward, neutral and reverse shifting as well as throttle operations. A trim button permits raising and lowering the drive to provide an optimum ride and the best vessel position (angle) as it travels through the water. As there is a neutral safety switch in the system the control must be in neutral to start the engine.

Understand all remote control functions before operating the vessel. The single control handle makes it much easier to maneuver in tight quarters. See the information following for basic component description and operation. *Note to read and understand the engine manufacturer's manual before attempting to operate the vessel remote control.*

Practice docking operations using the remote control in a controlled environment to learn the basic functions and the vessel's response to them.

## Safety Lanyard

Locate the remote control handle in the neutral position. Advance the neutral throttle position as instructed in the engine owner's manual. The function of the safety lanyard is to shut down the ignition should the captain become separated from the steering position such as falling down or losing consciousness. Connect the safety lanyard to a belt or secure piece of clothing. Ensure the lanyard is securely fastened to the remote control post. Keep passengers seated and away from helm controls at all times. Never leave the helm unattended while the engines are running.



## WARNING

LANYARD MUST BE ATTACHED TO THE OPERATOR WHILE THE ENGINE IS RUNNING. A QUALIFIED OPERATOR MUST BE IN CONTROL AT ALL TIMES. READ AND UNDERSTAND THE OWNER'S MANUAL BEFORE OPERATING VESSEL.



## WARNING

AVOID POSSIBLE INJURY OR DEATH! BEFORE MAKING HEADWAY. ENSURE THAT ALL PASSENGERS ARE OCCUPYING DESIGNATED SEATS. ENSURE THAT DRIVER HAS UNOBSTRUCTED VISIBILITY IN BOTH FORWARD AND AFT SECTORS.



## CAUTION

IF THE LANYARD IS IN THE "OFF" POSITION, THE ENGINE WILL CRANK OVER BUT WILL NOT START. ENSURE SAFETY LANYARD IS ATTACHED SECURELY TO A BELT OR SECURE PIECE OF CLOTHING AND THE REMOTE CONTROL PANEL.

## Remote Control Display Bar

There are several features found on the Volvo EVC or MerCruiser DTS remote control display. See the individual buttons on the display strip located on the previous page. They include trim assist, cruise control and tow mode. A brief description is found below. Note that the MerCruiser DTS remote control uses similar features. For a complete guide refer to the engine operator's manual.

**Power Trim Assistant-** Activate the PTA by pressing the Trim Assist button on the remote control. When you press the button again you deactivate the PTA. It automatically adjusts the trim angle to the engine speed. This feature permits trim functions to be loaded to control the in and out movement of the drive unit which control the boat angle and ride conditions. It eliminates the need to use the trim button on the side of the remote control handle. When the throttle changes the trim servos automatically "pair" themselves with the control handle position; full speed or anywhere in between they will seek the optimum trim angle for that speed.

*Note that the power trim assistant will not move the stern drive if it is manually trimmed above 7 degrees.*

*Note to ensure the PTA function is "off" if the vessel needs to be removed from the water. This eliminates automatic trimming of the drive if any test runs are performed with the rig land locked.*

**Cruise Control-** Activate the cruise control by pressing the button. This feature controls the vessel speeds in increments of 50 revolutions per minute shown as + or - on the control display. Each time the + button is pressed the engine rpm's increases by 50 rpm's. Each time the - button is pressed the engine rpm's decreases by 50. You can hit the plus or minus 5 times from where you have the throttles set. Beyond that it is time to move the controls and start again.

You might find yourself using this feature in heavy seas where you can make changes as wave height, current and wind conditions change and you do not want to manually use the control handle.

**Tow Mode-** Activate the tow mode by pressing the button. This feature is especially useful in water sports where you can program the throttle to remain at a specified rpm. Once programmed the tow mode will take the engine to that preset rpm which is best suited for the rider.

**Triangle Symbol-** The triangle icon lights up if the EVC system has registered a fault; refer to the Fault Code Information in the engine owner's manual.

**Mil Light-** (indicator light) lights up if the engine's emission system has registered a fault. At engine start, with the ignition on and the engine not running, the MIL will light on the control. This is a system test. The light will disappear when the engine is running unless there are engine faults.

## Remote Control Operation

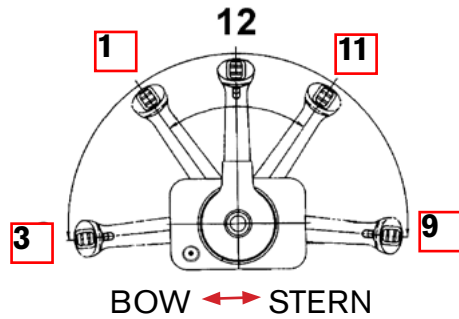

*Profile Of Typical Engine Control Lever Displaying Five Positions*



Shown here is the Volvo EVC (Electronic Vessel Control) remote control in a 12 o'clock or neutral position above with idle throttle control (left). This is the neutral position for starting and stopping

the engine(s). Press the N button to activate the neutral position and a flashing light appears. Now depress the lock button (provides start in gear protection) upward and this will permit advancing the throttle in a neutral position to warm up a cold engine.



Depress the lock button. Push the throttle control lever forward from the neutral 12 o'clock position to the 1 o'clock position and you will reach forward gear with minimal throttle. From the 1 o'clock position to the 3 o'clock position, the vessel is in forward gear with differing levels of throttle selections.

From the 1 o'clock position to the 3 o'clock position, the vessel is in forward gear with differing levels of throttle selections.



Shown here is the remote control in a full throttle forward (3 o'clock) gear position.

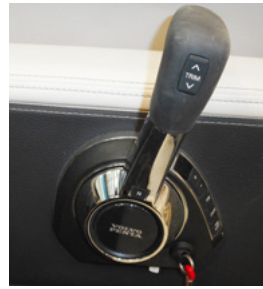

Pulling the throttle control lever back from the neutral 12 o'clock position to the 11 o'clock position will engage the reverse gear with minimal throttle. From the 11 o'clock position to the 9 o'clock

position, the vessel is in reverse gear with differing levels of throttle selections.



Shown here is the remote control in the full reverse position which shows as 9 o'clock.

See the diagram on the last page. This is a throttle position you would use for an emergency such as to avoid running aground or a collision. *Note that the operator needs to heed the warning that this throttle position under the right conditions could deposit large amounts of water over the swim platform or transom.*

The control lever features a *neutral safety switch* which ensures the engine and control are in the indented neutral position for starting the engine. You will hear a distinct tone and will feel the remote control's rotation lock in neutral when you shift from reverse or forward into neutral.

*Note that if you turn the key and the engine starter doesn't crank the engine, ensure the control lever is in the neutral position.*

*Note that the Volvo EVC stands for electronic vessel control and MerCruiser DTS stands for (digital throttle and shift). Both are known as "fly by wire" systems. Both systems assume similar control positions as shown above.*

## Hints For Shifting

- DO NOT shift quickly from forward to reverse gear positions. Drive system damage may occur.
- DO NOT “pump” the throttle in neutral as it is normally not needed since today’s engines use an enrichment valve system that requires very little starting throttle.
- DO NOT try to shift into forward or reverse gear at high rpm’s. Personal injury, drive system, or property damage may result.
- Only use idle throttle positions when docking or maneuvering in tight quarters.
- Wear your safety lanyard at all times.
- Never shift the controls with the engine not running.
- Always ensure you have unobstructed visibility before you shift into forward or reverse gears.
- For more information on remote controls and shifting read engine manufacturer’s operation manual before operating the remote control.

## Power Steering Operation

Both major engine manufacturer’s offer digital steering systems. The standard helm is replaced with a digital control wheel and instead of mechanical parts or hydraulic steering hoses connected to the steering helm/wheel the digital system transmits and communicates steering instructions from the steering wheel to the drive by electrical impulses in wires. They send a signal to the steering servo that controls the hydraulic rams to steer the vessel. The wheel feels effortless and all controls are fingertip gentle. Sometimes digital steering is called “fly by wire”.

*Note that whenever you check the engine oil it is recommended at that point to check the power steering reservoir fluid level. Fill with correct type of power steering fluid. See the engine owner’s manual for more information regarding power steering specifications.*



## LS2 Surf Engines & Systems



### Introduction to Regal Surf System

The following pages outline the basic operation of the Regal Surf System. Read and understand the Regal owner's manual, and surf system marketing materials before attempting to use the surf system along with any safety labels found in the engine/vessel manual or on board the boat itself. Always use an on board spotter to watch and communicate with the surf rider.

Remember the captain is responsible for his crew and maintaining his vessel. Safety first!!

The Regal Surf System utilizes Volvo forward drive propulsion along with other integrated components to offer boater's wake surfing, wake boarding or cruising options. The components include ballast bags, wave shaping surf tabs, and rider preferences for full surf control at your fingertips.



## Introduction To Surf Components

### Volvo Forward Drive Propulsion

This cutting edge technology utilizes two-forward-facing counter-rotating propellers which actually pull the vessel through the water rather than push it (older technology). The forward drive delivers a smoother and quieter ride with little vibration. Of course coupled with surf tab technology, the drive unit permits equally shaped wake surfing on either side of the vessel. The dual propellers are placed forward of the gear case located for optimal performance for water sports activities. By reducing prop ventilation, the Volvo forward drive produces better overall fuel economy and higher top end speeds.

### VOLVO FORWARD DRIVE



Also, by eliminating the exhaust passage in the prop hub it allows more propeller blade room which accentuates acceleration.



## Ballast Bags & Pump System



TYPICAL  
BALLAST BAG

An additional feature of the Regal surf system is the 3 ballast or sometimes called blatter bags. Usually the bags are placed as follows: 1 bag aft starboard, 1 aft port and 1 at the center line.

These bags are activated by electronic controls inside the chart plotter through an engine compartment mounted node module to fill/empty the tanks. The ballast bags feature Valmex PVC material, high end plasticizer and a welded process which produces bags with thermo-bonded seams. They are much stronger and durable than glued seams in the harsh marine environment.

Your vessel utilizes 3 reversible pumps to fill and empty the ballast bags. When the bags fill water is drawn through the hull bottom and sea cock to the desired bags pump. When the bags empty water exits through the sea cock and the hull bottom. The impeller that pulls water through the pump is a heavy duty polymer design and should provide longevity in a variety of water types. The impeller inside the pump spins around a cam which produces a low pressure area and pulls water through the pump. The port and starboard bags use the port sea cock as a water source through the hull bottom. The top hose on port sea cock runs to the port bag. The larger center bag uses the starboard sea cock.

*Note that the sea cock handle must be straight up (open position) to fill/empty the desired bag.*

*Note that the output pump hoses utilize a quick disconnect band (orange) for any maintenance needs.*



The surf water pump system requires little maintenance. It is a good idea to carry an extra replaceable impeller. Note that the pump O ring should be replaced and lubricated

when a new impeller is replaced.

## NOTICE

PREVENT WATER PUMP/IMPELLER DAMAGE!  
DO NOT RUN THE PUMP SYSTEM  
WITHOUT WATER OR WITH SEA COCK  
HANDLE CLOSED.

### Estimated Surf Ballast (Tank) Bag Fill & Empty Times

#### Fill Times

- 4:30 Port Ballast Tank
- 4:30 Starboard Ballast Tank
- 7:30 Center Ballast Tank

#### Empty Times

- 7:45 Port Ballast Tank
- 7:45 Starboard Ballast Tank
- 9:45 Center Ballast Tank

Note that all above estimated fill and empty rate times are in minutes and seconds. All times shown above are estimated.

## Typical Surf Boat Pump System

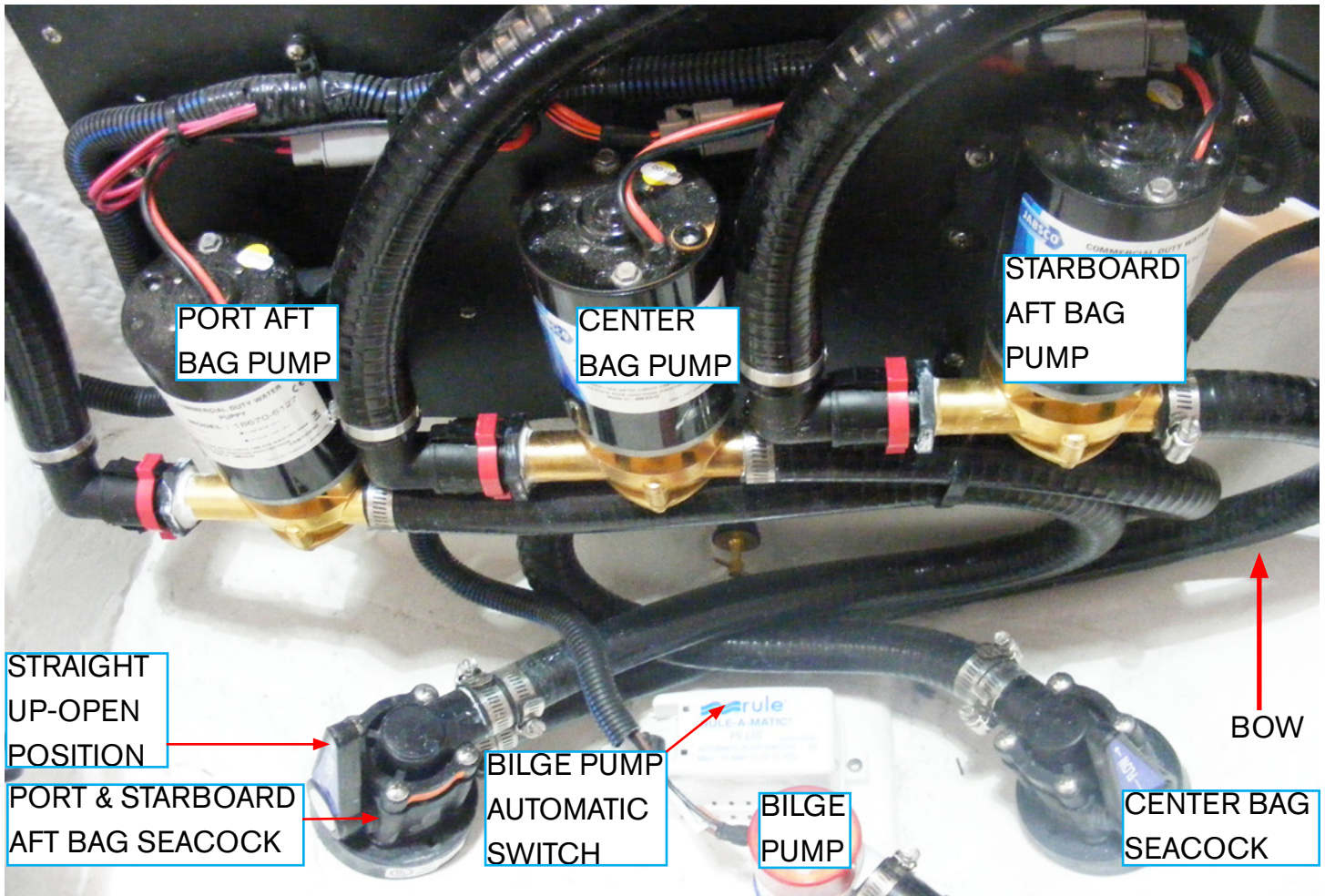

### Notes Regarding Wake Surf Pump System

1. In freezing climates contact your closest Regal dealer for winterizing the wake surf system along with the entire propulsion system. Dealers have the special tools and latest knowledge regarding these systems. Regal is not responsible for any damage due to improper winterization.
2. Periodically check the entire surf pump and ballast bag system for leaks and abrasions.
3. Never store anything in the bag compartments. Bag could fail due to heavy and/or sharp objects.

4. Periodically check all hoses and hose clamps to ensure all are securely fastened. Do not operate the surf pumps out of water as pump/impeller damage will occur.
5. If leaving the vessel in the water turn the surf pump sea cocks to the "off" position (90 degrees to the straight up position) and leave a note to yourself on the dash to turn sea cocks on before using the surf system again. Also, remove the keys from the ignition switch.

## Surf Tabs

The surf tabs operate using screw drive technology. This eliminates the possibility of hydraulic leaks as with fluid operated types.

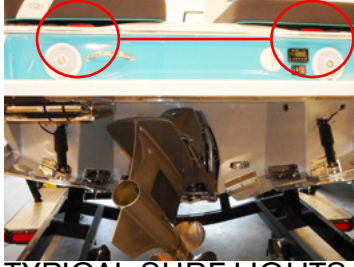

TYPICAL SURF LIGHTS

The surf tabs run independently of one another in 2 different positions; completely up or down. To begin you can choose the starting up position which

will permit the boat to be evenly planed before you start wake surfing. At that point you choose your desired side to ride (usually a higher wake position) on the chart plotter screen and the transom mounted red light will initially flash for the rider to be prepared and then the boat will list to the desired side and the red light will stop flashing and stay on through that surf cycle.

## Surf System Programming Basics



**Refer to the LS2 information regarding batteries, general DC electrical systems and remote control systems as they overlap in many ways. For detailed specific Surf engine information refer to your Volvo engine operator's manual.**

Your Regal boat features a Garmin plotter system that is used for GPS, engine, and surf related functions.

Refer to the water sports control operator's manual on the following pages for system rider profiles, surf tabs, ballast bag filling and emptying, surf rider optimum speed and quick launch perimeters.

The factory has set up the basic information on the plotter surf displays. Detailed and personal preferences can be set up under the preset perimeter guidelines.

In addition, further information is available in the Garmin plotter owner's manual and at the Volvo web-site.

Note that the sports control manual supplement is printed here by permission of Volvo Penta.

# OPERATOR'S MANUAL

Supplement - Water Sports Control  
V6-240, V6-280,  
V8-300, V8-350, V8-380, V8-430  
EVC



## Water Sports Control User Guide

### Water Sports Control



The Water Sports Control (WSC) system provides a single control unit for boat equipment that is used to fine-tune the boat's performance, ride, and wake during water sports activities. The system controls boat speed, trim tab deployment, drive trim angle, and ballast tank levels<sup>1</sup>.

Groups of settings can also be saved to provide quick return to boat settings that provided the wanted wake. This helps with repeatability of wakes for future boating sessions.

#### **⚠ CAUTION!**

Whenever possible make setting changes to the system while the boat is stationary. If setting changes are made when the boat is underway the operator must remain in full control of the boat, including keeping a watch for other boats, people, or obstacles in the boat's path.

#### **⚠ CAUTION!**

The operator should be prepared for changes to the boats steering and handling that may happen when the setting changes are activated.

<sup>1</sup> Control of trim tabs and ballast tanks requires installation of additional equipment and may not be available on your boat.

### Water Sports Control Display

See the owner's manual loaded in the display for options for displaying the WSC screen on the display.

This screen displays the functions available in the WSC program;



- ① The Water Sports Control icon, select here to activate WSC. Blue here indicates WSC is active.
- ② Move between the settable parameters with the arrow buttons.
- ③ Displays the parameter currently active.
- ④ Adjustments for the parameter.
- ⑤ User buttons. If active, the blue light on the left is lit. See *User* below.

#### Set Speed

Use this panel to set the speed for the water sports activity.

##### Set speed

Select the proper engine speed to create the wake you want for your type of water sports.

Use the + or – buttons to adjust the speed.

A valid GPS signal is required to use the Speed functions. The Speed Source must be set to Speed (not RPM), see Menu below.

**NOTE:** The speed must be below 14 mph to use surf modes.

## Water Sports Control User Guide

### User

You can set and name three groups of settings, to return easily to settings that provided a particular wake or ride.

When you have adjusted the settings for all four parameters and want to save them for future use, hold one of the **User** buttons, until the light is lit.

If that User button already has settings saved you will get an over-ride message; Overwrite this preset. Select **Yes**.

If a User is active the blue light is lit.

You can rename the Users, see Menu below.

### Menu

Several customizations are possible for the Water Sports program.

Select **Menu > Water Sports**

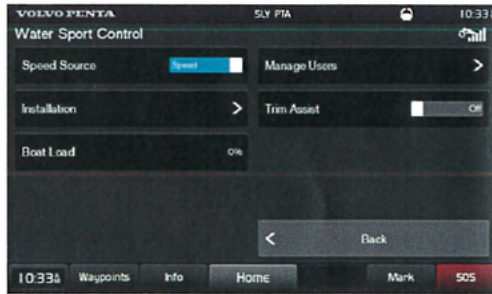

### Speed Source

Options are **Speed** and **RPM**.

Speed is the required for full Water Sports Control functionality.

If RPM is selected, only engine RPM and power trim angle can be set.

### Installation

There are two selections; Tank Fill and Tank Drain. These tank times are preset at the factory.

The setting can be adjusted if the pre-set times are not adequate. This can also be used to adjust for weakening pumps or for replacement pumps which may have different capacities.

### Boat Load

The boat load setting is used to compensate for any additional large load that is placed in the boat.

Normally this setting is not used (set at 0%).

However, if you install a heavy third party tank system or the installed tanks are very large, use this setting to compensate for the change in load. Adjust the slider to a value above 0% to approximate the new load.

Use the **Up** or **Down** buttons to move the slider.

This information helps the system adjust throttle response on take-off to compensate for the load condition.

**NOTICE!** Never exceed the weight limit posted by the boat manufacturer.

**NOTICE!** See the section *Static Water Line* in the engine's operator's manual before loading the boat.

### Manage Users

This is where you can customize the names for the Users.

Use the **arrows** to scroll through the Users.

At the desired User select **Rename**. The next screen (Preset Name) provides options for renaming. Select **Done** when finished.

**Reset** – resets the name and the parameters on the selected User to the factory default.

**Reset All** – resets the names and the parameters of all Users to the factory default.

### Trim Assist

This feature uses trim tab deployment to improve the boat launch from stationary to planning or water sports speed.

The settings are done by the factory.

The selection here is **On** or **Off**.

## Water Sports Control User Guide

### Operation

#### CAUTION!

Whenever possible make setting changes to the system while the boat is stationary. If setting changes are made when the boat is underway the operator must remain in full control of the boat, including keeping a watch for other boats, people, or obstacles in the boat's path.

#### CAUTION!

The operator should be prepared for changes to the boats steering and handling that may happen when the setting changes are activated.

After you have selected a User or manually entered settings, move the control lever in to the throttle position, the WSC system will maintain the settings you have selected.

Settings can be adjusted while underway, however remember that WSC only works at 14 mph and below.

Trim Assist helps the boat launch easier. It is activated when you select WSC or when you select PTA on the shifter. To use Trim Assist, it must be set to On in the Menu, see above.

At slow speeds, if Trim Assist is active, the trim tabs are down. If you are in reverse gear and throttle is above 10% Trim Assist is overridden and the tabs are retracted. Surf right or left also overrides the Trim Assist.

PTA (power trim assist) operates at speeds above the Water Sports limit. If it is activated the yellow PTA light is shown on top of the display. PTA on is also a way to activate Trim Assist.

The trim tabs are retracted when you turn the engine off.

For all selections a blue light indicates the feature is active.

A blinking blue light indicates the selected feature is not fully functioning. An example is a blinking blue light for a User, if Speed Source is set at RPM, the GPS (Speed) is not active and the User presets cannot be used (one parameter is Speed). To exit WSC return to idle or low speed and select WSC icon. Gray here indicates WSC is not active.

## LX2 Outboard Engine & Systems

### Introduction

This section covers selected topics unique to the LX2 outboard system including electrical, fuel, basic helm controls and equipment. More detailed information can be found in the outboard manufacturer's operator's manual.

*Become familiar with this entire manual since much of the previous chapters information coincides with the outboard model.*

Understand the manual before venturing out with the vessel.

Be sure to read and understand all caution, warning and danger labels. Furthermore, pay close attention to all notices as they relate to the vessel, engine, systems, and or other on board components.

Finally, refer to the owner's information packet or contact your closest Regal dealer for further product information.

## Electrical System

### Preview

In this section outboard related select electrical components are reviewed along with their location and function within the electrical system.

For more complicated issues outside the scope of this manual contact your closet Regal dealer. They have undergone extensive training and possess the tools for the Regal boat systems along with the engine and propulsion package.



## Batteries

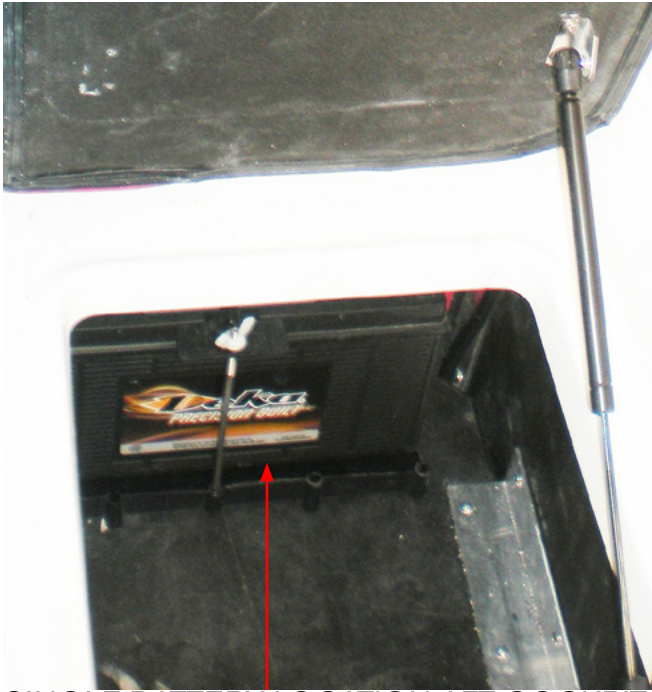

SINGLE BATTERY LOCATION AFT COCKPIT

Note optional 2nd battery location is under the port forward backrest under the enclosure.

All batteries are optional from the factory. Flooded lead, AGM, gel-cell, and maintenance free battery types are all approved for your outboard vessel. Typically a battery with a CCA between 680 -1150 and a reserve capacity of 160 minutes will work adequately with your engine. One battery is mainly for cranking and the other becomes a house type battery to run on board components. **When replacing batteries use the same type to ensure compatibility.** For more battery information refer to your Yamaha owner's manual or contact your closest Regal dealer.



## WARNING

TO PREVENT BODILY INJURY OR DEATH  
DUE TO FIRE OR EXPLOSION  
DO NOT STORE FLAMMABLE LIQUIDS  
OR PORTABLE GAS TANKS  
IN THE BATTERY COMPARTMENT  
OR ANY OTHER STORAGE AREA.

## Battery System Tips

1. Do not use any battery that does not meet the minimum specifications as the electrical system may be overloaded and cause electric system damage. Never use a battery that exceeds the CCA specs.
2. Ensure that the charging system is operating properly as the engine will not start with low battery voltage.
3. Do not store flammable liquids on board the vessel. See warning label.
4. Do not store items on top or near the battery bank as it may keep battery vapors from venting through the cover top.
5. Never turn the battery switch off with the engine running as charging system damage will result.
6. When installing battery cables red goes to positive (+) post & black goes to negative (-) post.
7. Periodically check the positive and negative leads and hardware for tightness / corrosion at terminals.
8. If flooded lead cell batteries are used periodically check the cell electrolyte level. Fill as needed with distilled water only. Do not overfill cells.
9. Wear protective eye gear and rubber gloves when servicing batteries.
10. Never smoke around batteries or bring any source of ignition near them.



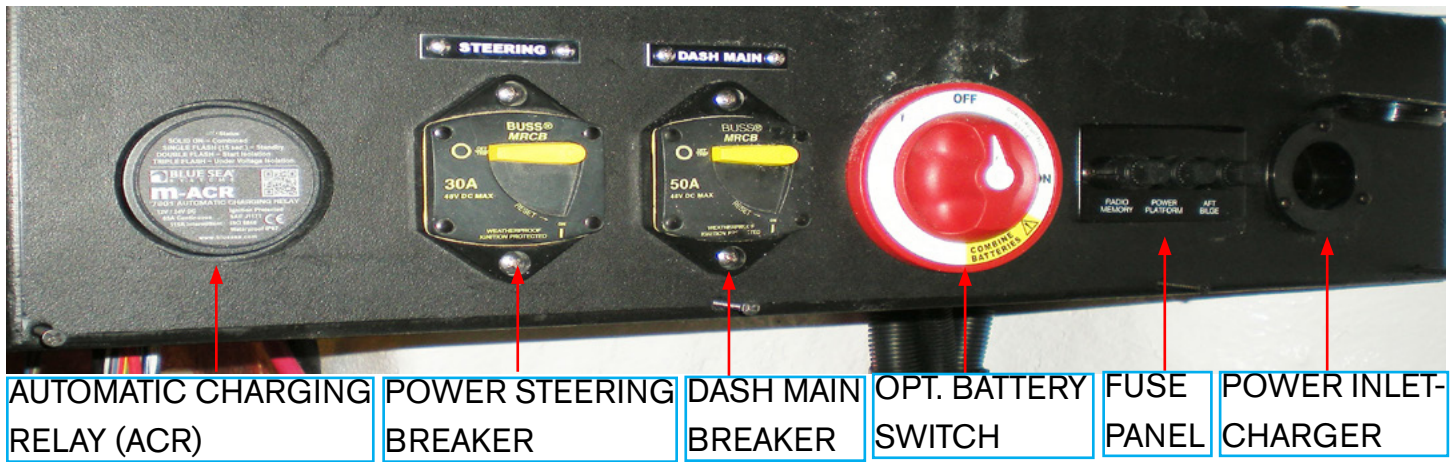

## Battery Management Panel

Note that select items mentioned may be options and not installed on your vessel. Found under the starboard lounge cushion is the battery management panel. Typically, this panel includes an ACR, ship's main system breaker(s), dual circuit battery switch, fuse panel, and battery charger cord power inlet.

### Automatic Charging Relay (ACR)

The ACR is designed to manage the charging current from outboard stators up to 65 amps. It includes a start isolation feature that protects sensitive electronics by temporarily isolating house loads from the engine circuit during engine cranking, protecting the house circuit from voltage spikes and sags.

The ACR works by sensing when the voltage of either battery rises to a level indicating that a charge source is active (13.0 volts for 2 minutes). At that point the ACR's contacts connect and the ACR applies to both batteries. If the voltage on both batteries subsequently drops to 12.75 volts for 30 seconds, the ACR disconnects and isolates the batteries.

ACR's use a relay combined with a circuit that senses when a charging source is being applied to either battery. Compared to battery isolators they create very little heat and consume little charging energy. Note that the ACR body encompasses a QR label which when connected through an app will take you to the web-site where you can find detailed operation and troubleshooting information beyond what is noted here.

### ACR Operating Hints

If the ACR does not disconnect when the engine is turned off it has not reached the low voltage threshold to isolate the circuit. It may take several minutes for the batteries to drop to this level. Since the ACR uses a delay, additional time up to 2 minutes before the ACR disconnects.

A slow flashing LED indicates that the start isolation wire is energized.

A fast flashing LED indicates one or both batteries are below 9.5 volts DC. Use table below as needed.

LED Status Chart		
LED	BATTERY STATUS	REASON
Solid ON	Combined	Charging
Single Flash (15 sec.)	Isolated	Standby
Double Flash	Isolated (Start Isolation)	Start Isolation wire is energized
Triple Flash	Isolated (Under Voltage Lockout)	One or both batteries are below 9.5V (12V System) 19V (24V System)

## Power Steering System Breaker

This 30 amp breaker protects the power assisted hydraulic steering system. This includes the pumps and the wiring circuitry.

*Note that if the breaker trips due to an overload find and correct the problem before resetting the circuit breaker.*

To reset push the breaker handle down until it reaches the “on” position at the bottom. A click will be heard as the breaker is reset.

## Dash Main System Breaker

This 50 amp breaker protects the wiring up to the dash.

*Note that if the breaker trips due to an overload find and correct the problem before resetting the circuit breaker.*

To reset push the breaker handle down until it reaches the “on” position at the bottom. A click will be heard as the breaker is reset.

## Dual Circuit Plus Battery Switch

This battery switch simultaneously switches two isolated battery banks or combines battery banks to all loads.

Optional dual battery switch designates “off”, “on” and “combine batteries” positions. This particular battery switch is connected to dual batteries and this set-up supplies additional reserve capacity to run extra accessories and to supply cranking amperage to start the engine with the other battery in a low charge condition.

To use this feature position turn the battery switch knob to the “combine batteries” detent (yellow labeled area). At this point you can start the engine. As this particular battery switch features a “make before break” footprint once the engine starts you can reposition the battery switch to the “on” detent to revert back to one battery for engine starting. It is recommended not to leave the dual battery switch in the “combine batteries” position as under the right conditions a severe discharge could result in both batteries becoming “dead”. An example of this condition existing would be anchoring your vessel without the engine running and playing the stereo for extended periods of time. In the combine batteries position both batteries could be drained completely.



## CAUTION

TO AVOID CHARGING SYSTEM FAILURE  
NEVER TURN THE BATTERY SWITCH  
TO THE OFF POSITION  
WITH THE ENGINE RUNNING!

## Fuse Panel

### Radio (Stereo) Memory

This fuse protects the radio (stereo) memory circuit. This allows you to keep all your stereo program selections when you leave your vessel even with the battery switch turned off.

### Power Platform

This fuse protects the optional power platform mounted under the swim platform. This component is only available on stern drive models.

### Aft Bilge Pump

This fuse protects the aft bilge pump which is usually found in the sump just forward of the engine. When you leave the vessel and turn off the battery switch as recommended the bilge pump circuit is still activated allowing the pump to work should a leak develop. An icon on the bilge pump helm switch lights to alert the operator that the pump is activated.

Note that the battery switch in the “off” position disconnects any voltage to the dash including the engine key switch.

 **WARNING**

TO PREVENT BODILY INJURY, DEATH OR PROPERTY DAMAGE READ AND UNDERSTAND THE GARMIN OWNER'S MANUAL BEFORE PROGRAMMING AND CRUISING USING THE CHARTPLOTTER FUNCTIONS.

## Shore Power Inlet- Battery Charger Cord

The shore power inlet is part of the battery charger option. **Use a 15 amp 3 blade extension cord of the correct size and length to compensate for current draw and voltage drop.** Normally the longer distance traveled requires a higher amperage extension cord. Read and understand the warning below and the extension cord tips on next page.

 **DANGER**

AVOID POSSIBLE INJURY OR DEATH!  
DUE TO ELECTROCUTION!  
DO NOT OPERATE THE BATTERY CHARGER  
WITH A TWO BLADED ADAPTER PLUG  
OR EXTENSION CORD.



**15 AMP 3 BLADE OUTDOOR EXTENSION CORD**

*For in field charging at most marinas today a 25 or 50 foot 15 amp 3 bladed outdoor extension cord will fit the needs of your on board battery charger. Make sure the outlet you are plugging into features 3 inputs and is a GFCI protected outlet. Note the earth ground round blade. The round 3rd blade in the extension cord provides a path thru the ground wire. It reduces the risk of electrical shock and fire.*

## Extension Cord Usage Tips

1. Use a 15 amp 3 blade outdoor extension cord of the correct size and length to compensate for current draw and voltage drop.
2. Never modify an extension cord or the vessel power inlet for the battery charger.
3. Never use an indoor extension cord outdoors.
4. Never plug 2 extension cords together to make a longer single cord.
5. Never let an extension cord lay in water.
6. Always check to ensure both ends of the extension cord are completely plugged into the power outlet and the power supply.
7. Never use a wet extension cord.
8. Store extension cords in a cool, dry place.
9. Never use a damaged extension cord where the insulation has been compromised.
10. Roll up the extension cord when not in use.
11. Upon initial use plug the extension cord in the vessel power inlet then into the shore power supply. When done charging unplug the extension cord from the shore power supply first before disconnecting from the vessel power inlet.
12. Most importantly, use common sense with extension cords around water!



## CAUTION

THIS VESSEL IS NOT EQUIPPED WITH A GALVANIC ISOLATOR. USING THE BATTERY CHARGER WHILE THE BOAT IS IN WATER MAY CAUSE DAMAGE TO THE BOAT'S ANODES AND/ OR DRIVE SYSTEM.

### Typical Battery Charging System Circuitry

*Note that the drawing below is for reference only.*

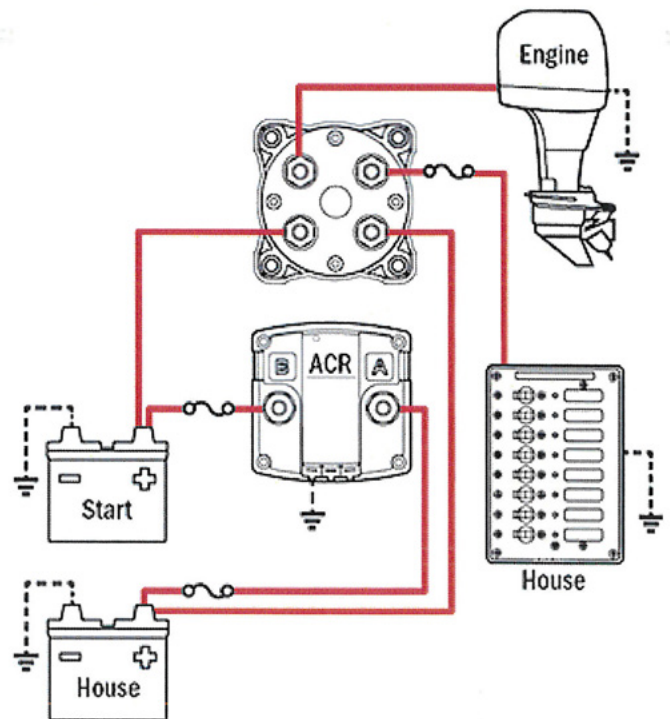



# AUTOMATIC CHARGING RELAY (ACR) DIAGNOSTIC FLOWCHART

## PN 7610 SI-Series Heavy Duty Automatic Charging Relay (ACR) Diagnostic Flowcharts

**SYMPTOM** The ACR will not combine batteries. The batteries are isolated and the green LED is OFF or blinking.

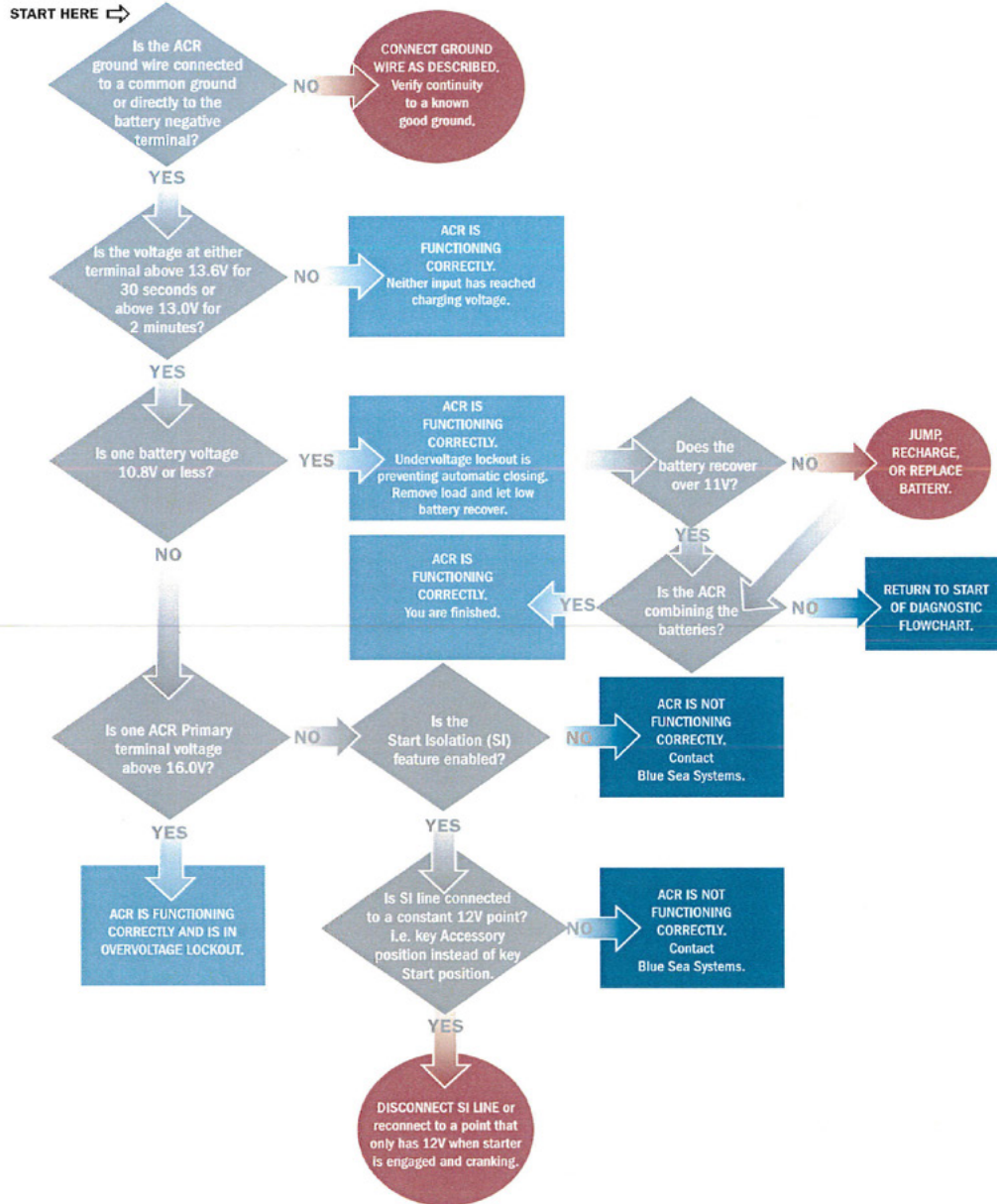

**SYMPTOM** The ACR will not isolate batteries. The batteries are combined and the green LED is ON.

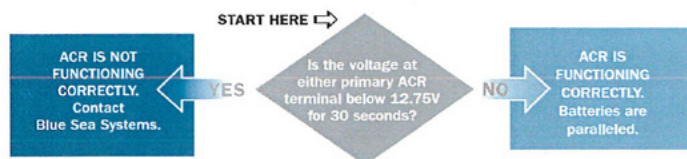

**LEGEND**

◊ Question	● Action	■ ACR is functioning correctly	■ ACR is not functioning correctly
------------	----------	--------------------------------	------------------------------------



425 Sequoia Drive,  
 Bellingham, WA 98226 USA  
 p 360.738.8230  
 f 360.734.4195  
 www.blueseasystems.com



## LX2 (Outboard) Helm Overview

Helm Overview- (Typical)

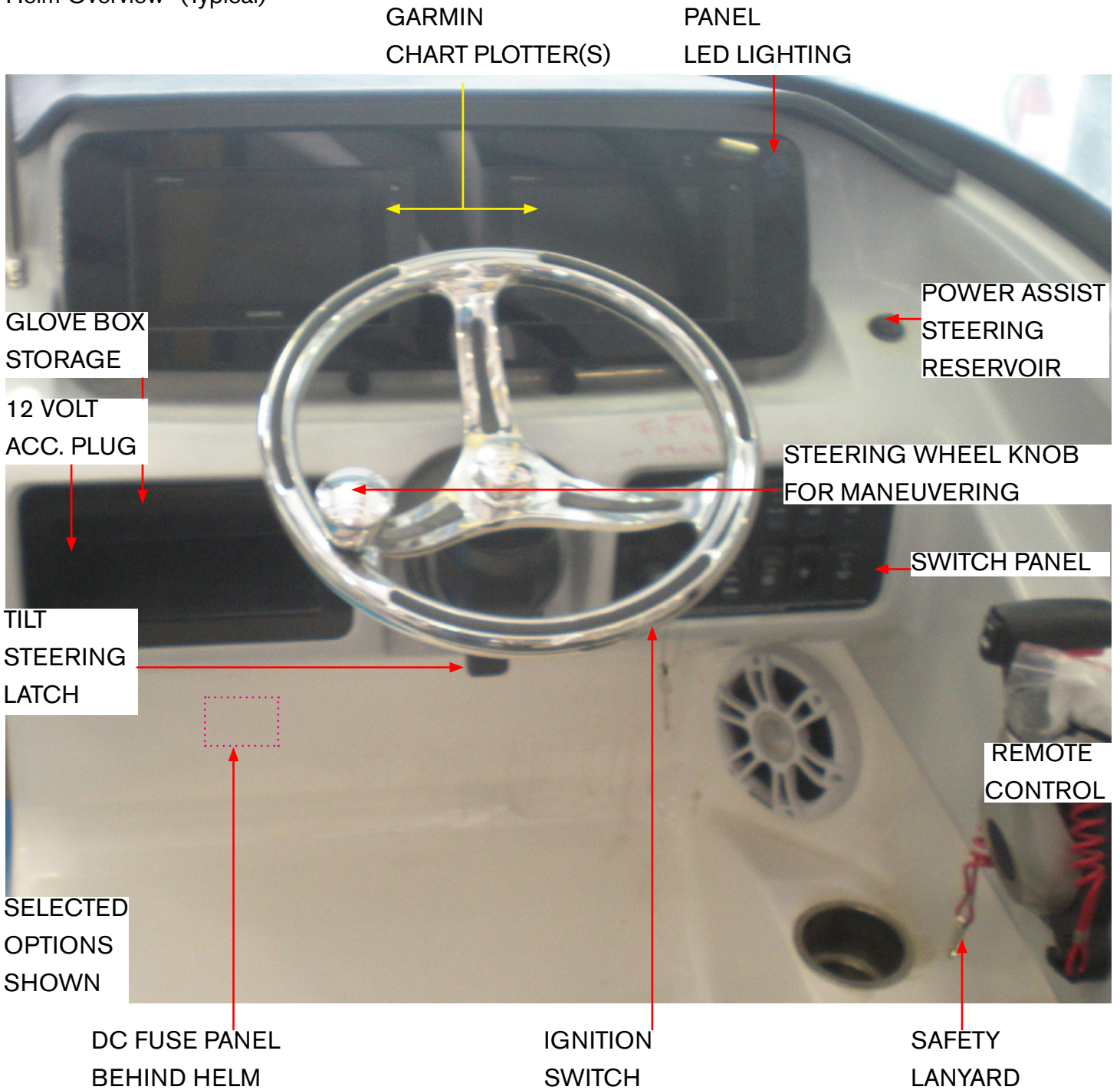

The helm station is equipped with the ability to monitor engine functions through a Garmin chart plotter (Dual plotter option shown). Close observation of the digital display is recommended. Read following pages for operational information.

The operator can split the screen to accommodate GPS functions along with monitoring basic engine systems including fuel usage and hours for maintenance cycles. This works in addition to the engine manufacturer's information panel system.

### Helm Controls

#### Introduction

Your vessel may be outfitted with a Garmin single or dual chartplotter. Select units are either sonar capable or function as a GPS without sonar capability. Both types of chartplotters will display water depth and engine functions.

All units feature a 7" touchscreen and are pre-loaded with US BlueChart® g3 and LakeVu g3 maps.

We will touch on basic start up procedures here. Refer to your Garmin manual for more detailed operating information or use the Garmin web-site at [support.garmin.com](http://support.garmin.com). Before venturing out be sure to read and become familiar with the chartplotter operation. Read and understand all warnings related to the use of the chartplotter.

*Note that all route and navigation lines displayed on the chartplotter are only intended to provide general route guidance or to identify proper channels and are not to be precisely followed. Always defer to the navigation aids and water conditions when navigating to avoid grounding or hazards that could result in vessel damage, other property damage, personal injury or death.*

#### Quick Start Information

#### Chartplotter Overview & Feature Description



1. This is the touchscreen indicator.
2. This is the power key. Press and hold to activate the unit.
3. This is the back light sensor. To change brightness you can repeatedly press the power button to scroll through the various brightness levels.
- 4 Under the cover are 2 micro SD memory card slots. Maximum card size is 32GB formatted to FAT32. To use slots lift the cover and insert card into slot until it clicks. Shut the door. If the card resists when inserted turn it 180 degrees and try again. Read more about memory card usage features in your Garmin manual which can be downloaded at [www.garmin.com/manuals/GPSMP702-902](http://www.garmin.com/manuals/GPSMP702-902).

***Note that features may differ from model to model including equipment installed on your vessel.***

## Hints & Tips Regarding Garmin 742

1. The units are protected by a 7.5 amp fuse located on the fuse block under the starboard helm which can be accessed by pulling the backrest up.

2. The Garmin system is controlled by the battery switch. With the battery switch in the “off” position the units can not be powered up.

3. This unit provides GPS and chartplotter information. Sonar readings are not available on this unit.

4. Fusion stereo entertainment functions can be controlled from the Home screen on the chartplotter. Read and understand the Fusion owner’s manual.

5. The chartplotter can be customized by accessing the Home screen. Once there use the Status bar, Pages buttons, Categories bar, and Menu bar to choose, add, and save your customized features.

6. Refer to the Garmin owner’s manual for information on the Active Captain App.

7. Select Home from any screen to return to the Home screen.

8. Select Menu to open more settings regarding that screen,

9. Select Menu to close the menu when completed.

12. Press the power button to open more options, such as locking the touchscreen or adjusting the back light.

13. Press the power button to deactivate the chart plotter.

14. If unit not operable first check for power to the helm, Garmin fuse, and NMEA 2000 network fuse.

15. As stated before all units display depth, fuel tank level, engine functions including warnings and alarm data.

16. Standard NMEA 2000 support for network conductivity including autopilots, digital switching, weather, Fusion-link, VHS, AIS and other sensors.

## Outboard Engine Starting, Stopping and Shifting Guidelines

### Fueling- Pre-Starting Procedure

#### Before Fueling

1. Make sure a working fire extinguisher is available.
2. Stop engines and any device that can cause a spark.
3. Disembark all passengers and crew not needed for fueling.
4. Fuel if possible during the daylight hours.
5. Check to ensure nobody is smoking in the boat or near the fueling dock.
6. Close all portholes, hatches and doors to keep vapors from blowing aboard and settling in the bilge.
7. Tie up your boat securely at the fuel dock.
8. Identify the fuel fill. Unfortunately, people have mistakenly filled the water or waste with fuel.
9. Visually inspect all fuel system components before each filling.
10. Avoid using fuels with alcohol additives. They can attack fuel system hoses and cause deterioration.



## DANGER

AVOID PERSONAL INJURY OR DEATH!  
GASOLINE IS A HIGHLY FLAMMABLE  
AND EXPLOSIVE MATERIAL.  
PRACTICE "NO SMOKING" AND EXTINGUISH  
ALL FLAMMABLE MATERIALS  
WITHIN 75 FEET OF THE FUEL DOCK.



## WARNING

AVOID SERIOUS INJURY OR DEATH  
FROM EXPLOSION OR FIRE  
RESULTING FROM LEAKING FUEL!  
INSPECT ENTIRE FUEL SYSTEM  
AT LEAST ONCE A YEAR.



## WARNING

AVOID INTERNAL ENGINE DAMAGE!  
SINCE GASOLINE IS AVAILABLE  
IN SEVERAL GRADES  
INCLUDING ETHANOL AND VARIOUS  
OCTANE LEVELS, REFER TO THE ENGINE  
MANUFACTURER'S OWNER'S MANUAL  
FOR CORRECT GAS TYPE/GRADE.  
USING THE IMPROPER OCTANE LEVEL  
OR THE WRONG GASOLINE TYPE  
CAN CAUSE ENGINE DAMAGE  
AND WILL VOID THE WARRANTY!



## During Fueling

1. Keep the fuel nozzle in contact with the fuel fill to guard against static sparks. The fuel fill pipe is grounded through the fuel system wiring to protect against static electricity.

2. Avoid overfilling the fuel tank. Leave room for expansion. Also, if fuel exits the fuel vent indicating the tank is full, this situation is dangerous and unfriendly to the environment.

3. Avoid spilling any fuel. Clean up any fuel accidentally spilled with a clean rag and dispose of it properly.



FUEL FILL CLOSED AND POINTS LINED UP

## After Fueling

1. Close all fuel fill openings tightly until the two red points line up on the fuel fill cap/casting. This is the proper locked/sealed position.

2. Open all hatches as needed.

3. Sniff in the lower bilge and floor storage locker (shown below) for gas fumes. If fumes are detected continue to ventilate until the odor is gone. Look for any traces of fuel droplets or spillage. Do not start the engine, smoke or run any electrical components until the fumes can no longer be detected.

4. Locate the fuel line primer bulb. Hold it at an upward angle and pump it until firm. Periodically check the bulb for loose connections especially at the fuel tank and at the engine end. Also, check for signs of cracking on the bulb rubber surface which can develop with humidity and age. If the primer bulb ever needs replacement make sure the arrow is in line with the fuel flow to the engine.



FUEL PRIMER BULB IN SUMP AREA



## **FUEL OCTANE**

*Note to read and understand the following fuel octane level warning and information.*



## **WARNING**

AVOID INTERNAL ENGINE DAMAGE!  
SINCE GASOLINE IS AVAILABLE  
IN SEVERAL GRADES  
INCLUDING ETHANOL AND VARIOUS  
OCTANE LEVELS, REFER TO THE ENGINE  
MANUFACTURER'S OWNER'S MANUAL  
FOR CORRECT GAS TYPE/GRADE.  
USING THE IMPROPER OCTANE LEVEL  
OR THE WRONG GASOLINE TYPE  
CAN CAUSE ENGINE DAMAGE  
AND WILL VOID THE WARRANTY!

Outboard engines depending on the model may require a mid-range octane level (89) versus a lower regular octane level (87). Refer to your outboard manufacturer's operation manual for correct information regarding the proper octane level for your outboard model.

Using the wrong octane level may cause permanent internal engine damage which is not covered under your warranty.

For additional information contact your outboard manufacturer's hot line or your closest Regal dealer.

## Starting Outboard Engine

The following general information covers the starting and stopping of your outboard engine. Read and understand all previous information on remote controls, fueling and operational procedures. Pay particular attention to all danger, warning and caution labels. Refer to the engine owner's manual for in depth propulsion system information.

Review all pre-departure information. Before starting your engine make sure all canvas is stored.

Start engine only in a well ventilated location to avoid CO buildup.

Turn the battery switch to the "on" position.

Set the remote control handle in the neutral straight up position. Advance the neutral throttle position as earlier instructed or refer to the engine owner's manual.

Connect the safety lanyard to a belt or secure to the arm. Keep passengers seated and away from controls.

## Starting Outboard Engine Guidelines

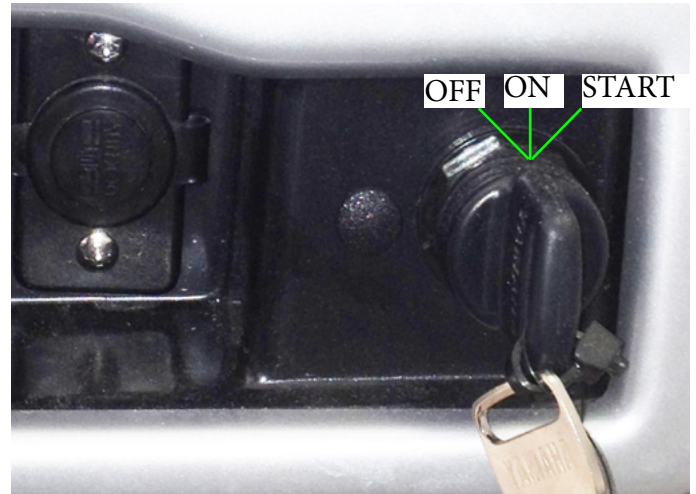

Refer to the key switch position photo above. Turn the ignition key right to the "on" position. This is known as the "run" or ignition position. Turn the key further right to the momentarily "start" position. Since this key position is "spring loaded" you will need to hold it there. You will hear the starter cranking over the engine. When the engine starts release the key switch. It will automatically align itself in the run position (ignition).

If the engine does not start refrain from cranking the engine over 10-12 seconds. Allow the starter and battery a chance to recover.

Once the engine starts, advance the remote control in the neutral throttle position as recommended in the engine manual. Let the engine warm up for a few minutes. Do not race the remote control in the neutral position.

## After Starting Outboard Engine



1. Check for a steady stream from the cooling water pilot hole located on the starboard side of the outboard on a casting below the shroud. Water must be flowing at all speeds out of the pilot hole (see photo). A less than steady flow may indicate possibly one of the following:

- a. Obstruction in the power head water passages
- b. worn water pump or plate
- c. Weeds covering water intakes on vertical drive housing.
- d. Pilot hole is plugged with debris. Take a small solid core wire and move it in and out of the pilot hole several times while engine is running. If flow increases the take time to further clean the pilot hole.

2. Let the engine warm up for several minutes listening for any alarms or low oil pressure alerts along with watching the analog helm gauges on selected models. In another scenario the operator can activate the Garmin chartplotter and program the unit to the engine gauge screen and observe the gauge functions.



# WARNING

AVOID INTERNAL ENGINE DAMAGE!  
CHECK THE LOW OIL PRESSURE ALERT INDICATOR AFTER STARTING.  
IF BLINKING SHUT DOWN ENGINE AND INVESTIGATE THE PROBLEM.  
CALL YOUR CLOSEST REGAL DEALER OR MARINE PROFESSIONAL IF THE CAUSE OF THE PROBLEM CAN NOT BE FOUND.

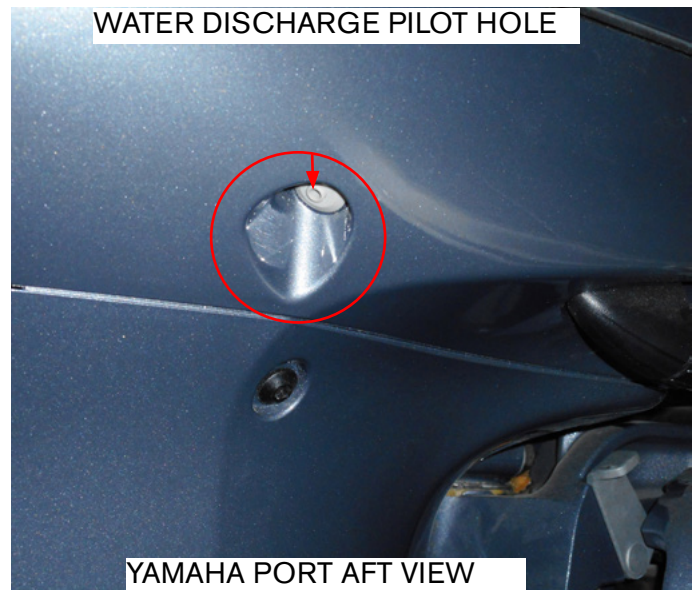

## TYPICAL GARMIN GAUGE DISPLAY



\* NOTE THAT YOUR GARMIN CHARTPLOTTER MAY SLIGHTLY DIFFERENT FROM DISPLAY ABOVE

As installed the Garmin chartplotter single or twin display features many GPS features along with the ability to monitor engine system functions which may include revolutions per minute (rpm's), GPS speed, voltage, fuel flow rate, trim, and temperature along with tracking engine hours.

*Note that the Garmin chartplotter can control the Fusion entertainment system through the NMEA 2000 backbone.*

1. To power up the Garmin GPS press the on button located on the upper right display.

2. The function AV/Gauges,Controls will appear as one of the choice boxes. Press the box. Another screen with engine will appear.

3. Press the engine box and the engine gauge displays will appear.



## Stopping Vessel

Allow your vessel to lose all headway before shifting from reverse or forward gear into neutral. Do not use the reverse gear function to stop the boat at speeds above idle as it could cause the operator to lose control, be ejected or impact steering wheel functions.

*Note that bodily injury could occur or damage to the shifting mechanism including the gear case gear unit.* Do not shift into reverse at planing speeds as the operator could lose control, be ejected or the vessel could be swamped by taking water over the transom area.

Remember that the operator is responsible for his passengers! The vessel cannot “stop on a dime” but requires a safe distance to stop headway. Of course this distance is effected by water current, wind velocity and direction, along with the weight of the boat and how it is balanced.

Passengers shall occupy designated seating positions while the vessel is making headway. Make sure everyone including the operator is wearing their life vests while cruising.

## Stopping Outboard Engine

If available it is always a plus to fill the vessel at the marina gas dock if vessel is moored there as you will be then ready for the next cruise.

After cruising and returning to your mooring let the engine cool down at an idle position for several minutes.

Turn the ignition key to the “off” position or pull on the safety lanyard cord to stop it. This last endeavor assures that the cut-off system is functioning properly.

Remove the key from the ignition switch. Do not leave the key on the vessel to avoid possible theft. Store at home on a key rack for future use. It is recommended that you put your boat key on a float to prevent submersion and subsequent loss.

When the engine has stopped turn off the single or dual battery switch at the aft located battery management panel.

Cover the vessel with appropriate bow and cockpit covers and/or mooring cover if installed.



## Helm Controls

### Introduction

In this section outboard related helm controls are featured. This section covers select basic component operation. For more detailed information refer to the Yamaha outboard owner's manual and your information packet.

### Digital Electronic Remote Control Box

The remote control actuates the shifter and throttle operations of the engine. The remote control box typically is a key player in electronic functions such as alerts and active indicators. It features a side mount design and includes safety components such as a safety lanyard.

**Read and understand the control box shift and throttle functions before venturing out in the water.** At that point practice using the remote control until you understand its functions and how the vessel reacts to it. Practice maneuvering in a uncluttered environment.

On the following page is a description of the remote control and its safety components. For further information refer to the outboard engine operator's manual or contact your closest Regal dealer.

TYPICAL DIGITAL CONTROL SHOWN IN NEUTRAL POSITION



A typical digital outboard remote control is shown above. This control is in the straight up (neutral starting) position. Note that mechanical controls are used on select outboard models.

The interlock switch prevents starting the engine in gear. It is normally found under the far side of the remote control handle and is colored red. When the engine starts to run the interlock switch must be pulled up and held until the remote control handle is shifted into forward or reverse gear.

The up and down buttons control the trim of the outboard in reference to the bow altitude of the boat. Before starting the engine make sure the unit is trimmed to the down position.

When the neutral throttle only button is pushed in and the control lever is shifted forward the engine speed increases for a faster **neutral** idle. When the control handle reassumes the straight up neutral position after warm up the remote control can be then shifted into forward or reverse gear.

The shut-down cord is a safety device that when pulled will shut down the engine by interrupting the ignition. It shall be worn by the boat operator any time the engine is running. Feed the clip around a belt for example or your arm and latch the clip to the cord. Do not use belt loops or clothing as they may not be adequate to hold in an emergency situation.

Make sure the shut-down cord is attached to the switch on the control box as the switch upon latching will be in the 'on' position.

Note that the engine will not start but will crank only with the cord shut down switch in the "off" position.



## WARNING

AVOID SERIOUS INJURY OR DEATH!  
ENSURE OPERATOR HAS SUFFICIENT  
SLACK IN THE SHUT-DOWN CORD  
WHEN UNDERWAY. IF THE CORD  
ACCIDENTALLY COMES OFF THE CONTROL  
BOX OR ON SOME MODELS THE HELM  
SWITCH THE ENGINE LOSES POWER  
AND STEERING CONTROL  
IS SEVERELY REDUCED.  
ALSO, THE VESSEL SLOWS DOWN RAPIDLY  
WHICH COULD CAUSE PEOPLE AND  
OBJECTS TO BE PROPELLED FORWARD.

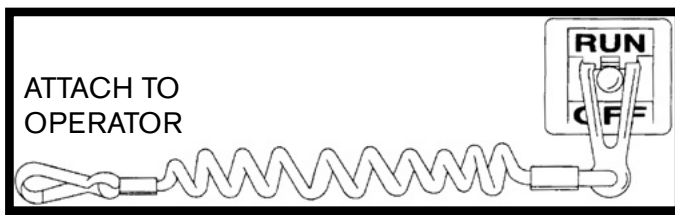

TYPICAL SHUT-DOWN SYSTEM



## WARNING

AVOID SERIOUS INJURY OR DEATH  
DUE TO A RUNAWAY BOAT  
IF THE OPERATOR IS EJECTED  
OVERBOARD!  
ALWAYS HAVE THE SHUT-DOWN CORD  
ATTACHED WHEN THE ENGINE  
IS RUNNING.  
MAKE SURE THERE IS SLACK IN THE SHUT-  
DOWN CORD FOR BODY MOVEMENT.

← BOW STERN →

*Profile Of Typical Engine Control Lever Displaying Five Positions*

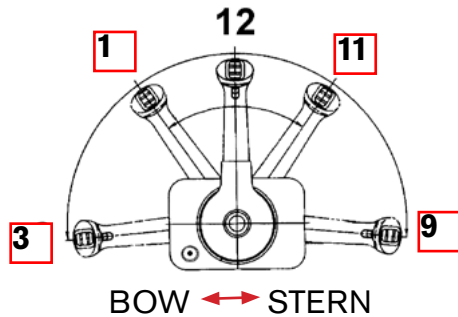

Pushing the throttle control lever forward from the neutral 12 o'clock position to the 1 o'clock position will engage forward gear with minimal throttle. From the 1 o'clock position to the 3 o'clock position, the vessel is in forward gear with differing increased levels of throttle selections.

Pulling the throttle control lever back from the neutral 12 o'clock position to the 11 o'clock position will engage the reverse gear with minimal throttle. From the 11 o'clock position to the 9 o'clock position, the vessel is in reverse gear with differing increased levels of throttle selections.

As you shift from neutral to forward or reverse, pull the neutral release button up; this allows the control lever to come out of the indented neutral position.

The control lever features a neutral safety switch which ensures the outboard and control are in the straight up neutral position for starting the engine. You will hear a distinct sound and will feel the remote control's rotation lock, once in the proper position. If you turn the key to the start position and the engine starter doesn't crank the engine, ensure the control lever is in the neutral position.

Your control lever also features a trim control switch. This switch allows the captain to set the outboard trim position either up or down to achieve a plane position.

## FOLLOW THESE TIPS WHEN SHIFTING:

- DO NOT shift quickly from forward to reverse gear positions. Outboard drive system damage may occur.
- DO NOT "pump" the throttle in neutral or flooding will result. The same thing will happen if you keep pumping the automobile accelerator pedal. Today's engines use direct fuel injection systems that require very little starting throttle.
- DO NOT try to shift into forward or reverse gear at high rpm's. Personal injury, drive system, or property damage may result.
- Only use idle throttle positions when docking or maneuvering in tight quarters.

## Shifting Guidelines



Before shifting into reverse or forward gear positions make sure the coast is clear. When shifting to either gear from neutral make sure the throttle is in the idle position.

Warm up the engine at least 3 minutes in neutral before shifting into gear. Before the engine is at operating temperature, the idle speed may be higher than normal. High idle speed can keep you from shifting back to the neutral position.

If this occurs, shut down the engine and shift the gearshift into neutral. Restart engine and allow normal warm-up period.

When ready to shift the remote control lever **out of neutral into gear** move it firmly crisply forward (for forward gear) or aft (for reverse gear) or around 35 degrees you will feel a detent at this point in the forward or reverse gear positions. After this point in the forward or reverse gear position the remote control lever picks up throttle only.

When ready to shift the remote control **from either forward or reverse gear into neutral** pull the throttle slowly from either gear firmly to the straight up neutral position. Be prepared for the vessel to take a few seconds for the vessel to slow headway and to assume an engine idle position.

Practice shifting! You will become more familiar with the procedure and self-confidence will build especially in tight docking situations. Stay alert at all times!



## LX2 Engine Notes, Checks, & Maintenance

Note that many of the Regal systems and components are similar between the stern drive, surf and outboard models. For that reason it is recommended that the operator read this entire manual to become familiar with the various systems. Also, read and understand the outboard manufacturer's propulsion manual before operating the propulsion system in a cruising mode.

In this section we will briefly explore various outboard system engine checks and maintenance information.



TYPICAL OUTBOARD SHOWN

## Before Operating Engine

Following are basic instructions and tips before and after starting your outboard engine. For more in depth information refer to your outboard engine owner's manual. Be sure to read and understand all safety labels along with all other related information before attempting to operate your craft.

### Checking Crankcase Oil Levels

Remove the shroud (cover) and check the crankcase for proper oil levels. Remember that a 4 cycle outboard uses crankcase oil to lubricate all internal engine components such as crankshaft, rods and pistons along with all related bearings and seals. For changing crankcase oil contact your closest Regal dealer for additional information since they have the special tools and knowledge for these maintenance procedures. Check your outboard owner's manual for correct oil type and viscosity. See figure 1 for dipstick location.



FIGURE 1

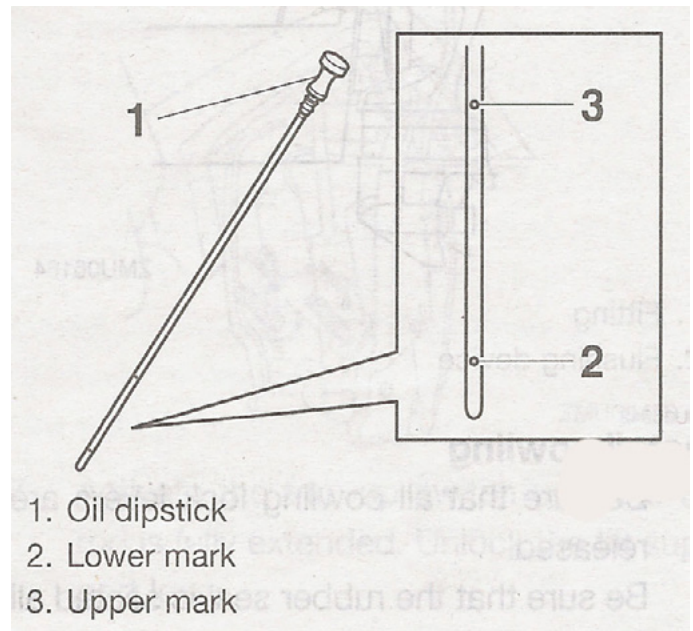

To check the crankcase oil do the following:

1. Ensure the outboard is setting in a flat vertical position or the dipstick may not display an accurate oil level.
2. Remove the crankcase oil dipstick and wipe it clean.
3. Reinstall the crankcase oil dipstick completely into the hole. Remove it again.
4. The oil level should be between the upper and lower dipstick holes. As needed add the manufacturer's recommended oil or contact your closest dealer especially if the oil is contaminated with water which will show a milky color verses a clear or light amber look.

TYPICAL EPA FUEL SYSTEM

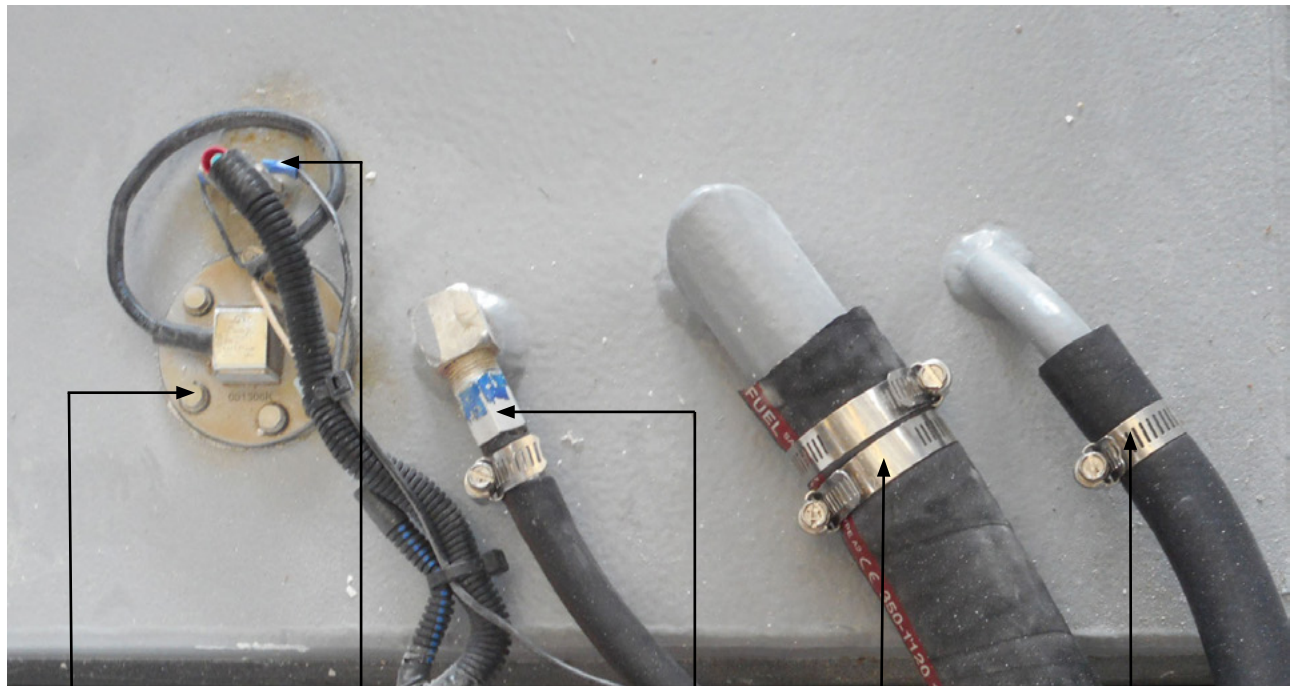

FUEL  
SENDER

TANK  
GROUND

ENGINE  
FEED

FUEL FILL

VENT

Before each outing check the fuel tank components including hoses and related clamps. Be sure to sniff for gasoline vapors in the process. If any vapors exist find the source of the leak and repair as needed. At that point ventilate the compartment until all vapor smell is gone.

Read and understand the following fuel system warning labels.



**WARNING**

AVOID SERIOUS INJURY OR DEATH  
FROM EXPLOSION OR FIRE!  
NEVER STORE FUEL  
OR FLAMMABLE LIQUIDS  
ON BOARD.



**WARNING**

AVOID SERIOUS INJURY OR DEATH  
FROM EXPLOSION OR FIRE  
RESULTING FROM LEAKING FUEL!  
INSPECT ENTIRE FUEL SYSTEM  
AT LEAST ONCE A YEAR.



## CHECKING ENGINE MOUNTED FUEL FILTER



As part of select outboards under the motor shroud (engine cover) on the lower port side of the outboard engine is a fuel filter. A cover may need to be removed to access the filter. Periodically check to ensure the fuel filter is clean and free of water. When reinstalling the filter tighten to manufacturer's specifications. Check for leaks after starting the engine. For more information refer to the outboard manufacturer's owners manual or contact a Regal dealer or marine professional.

## CHECKING IN-LINE WATER SEPARATOR FILTER



Inside the aft port cockpit seat storage area is a 10 micron in-line water separator filter. Use an oil filter type wrench that fits the filter bottom footprint and turn the filter counterclockwise to remove the element. Using a clean pan empty the filter contents and examine the fuel. Water in fuel tends to hug the bottom since it is heavier than fuel and will show a different look. At least yearly or on an as needed basis replace the filter element. Fill the element up with fresh unleaded fuel of the correct octane rating and turn it clockwise until tight. If needed finish tightening with a belt or spanner wrench that will not damage the filter body. As always check for leaks before starting the engine.

It is a great idea to keep extra filter elements on board in protective wrap for emergency use.

## Checking Power-Assisted Power Steering System

Your outboard may feature a mechanical-hydraulic rack style steering system. The unit utilizes valves which permit hydraulic fluid to pass through the system allowing the steering arm at the outboard to turn the vessel to port or starboard. This check valve cluster is located behind the steering wheel. The hardware at both the helm and engine ends must be checked regularly for tightness, lubrication, and leaks. Check the steering system for full steering to port and starboard before disembarking. Typical hydraulic pump shown below. It is normally located under the aft port cockpit seat storage area. Refer to your outboard motor operator's manual for adding fluid to the pump and type required.

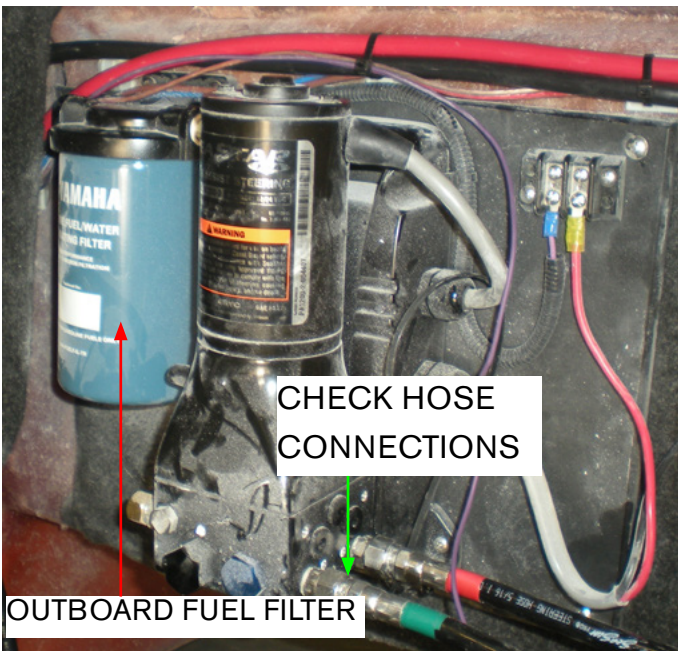

TYPICAL HYDRAULIC STEERING PUMP

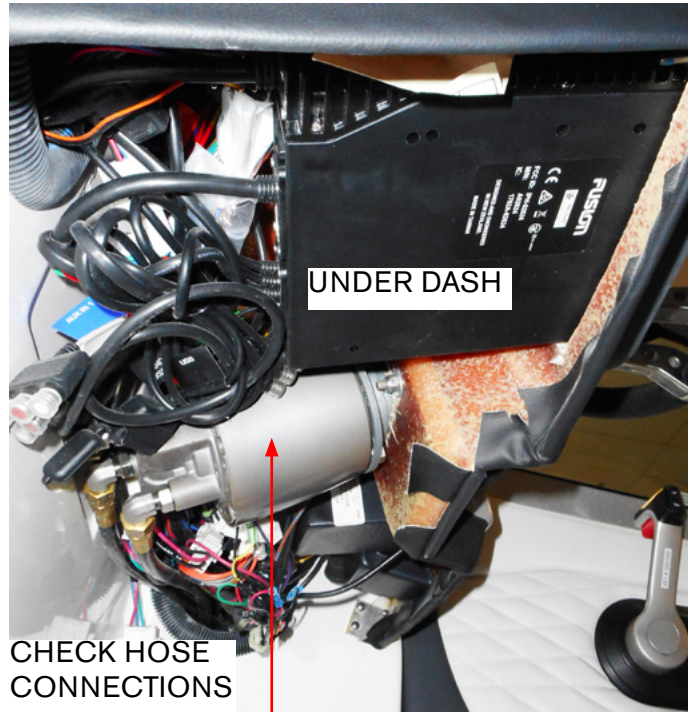

HYDRAULIC RACK STEERING CLUSTER



STEERING HARDWARE & HOSES AT ENGINE



## Filling Helm Steering Reservoir

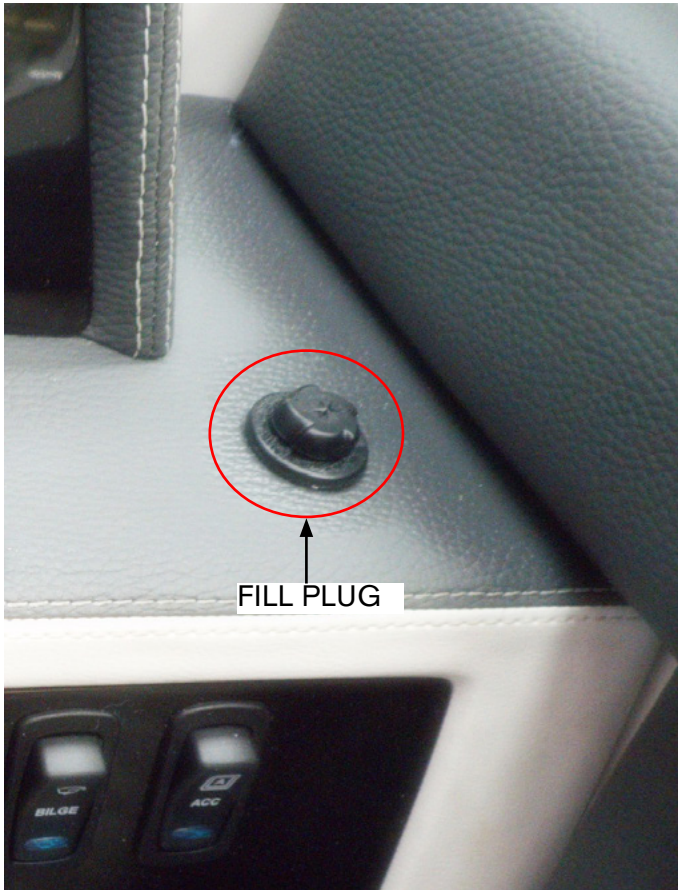

FILLING HELM HYDRAULIC STEERING FLUID

There is a fill plug located at the starboard helm used to add hydraulic fluid to the steering system. There is a hose kit used to fill the system. Note that Sea Star Solutions recommends Seastar Hydraulic Steering Fluid for use with the filler kit.

Any non-approved fluid may cause serious damage to the steering system resulting in possible loss of steering, causing property damage, personal injury or death.

Contact your closest Regal dealer or marine professional for system filling instructions since the steering system may need to be purged of air by opening bleed fittings as the wheel is turned port and/or starboard.

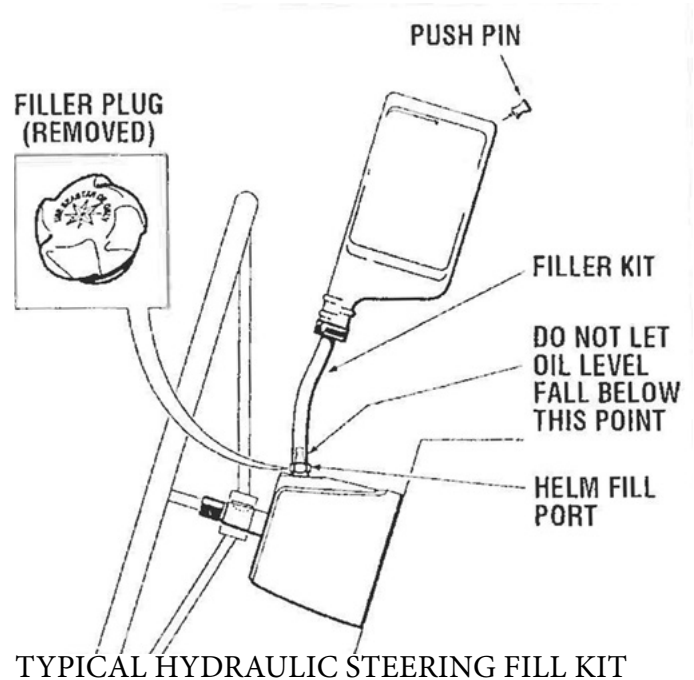

## **WARNING**

**AVOID SERIOUS INJURY OR DEATH!  
THE OPERATOR OF THE CRAFT  
MUST HAVE COMPLETE CONTROL  
OF THE HELM STEERING STATION  
WHILE THE VESSEL IS MOVING.  
NEVER LEAVE  
THE HELM STATION UNATTENDED  
WHILE THE VESSEL IS MOVING.**

# SEA STAR STEERING SYSTEM SCHEMATIC OVERVIEW

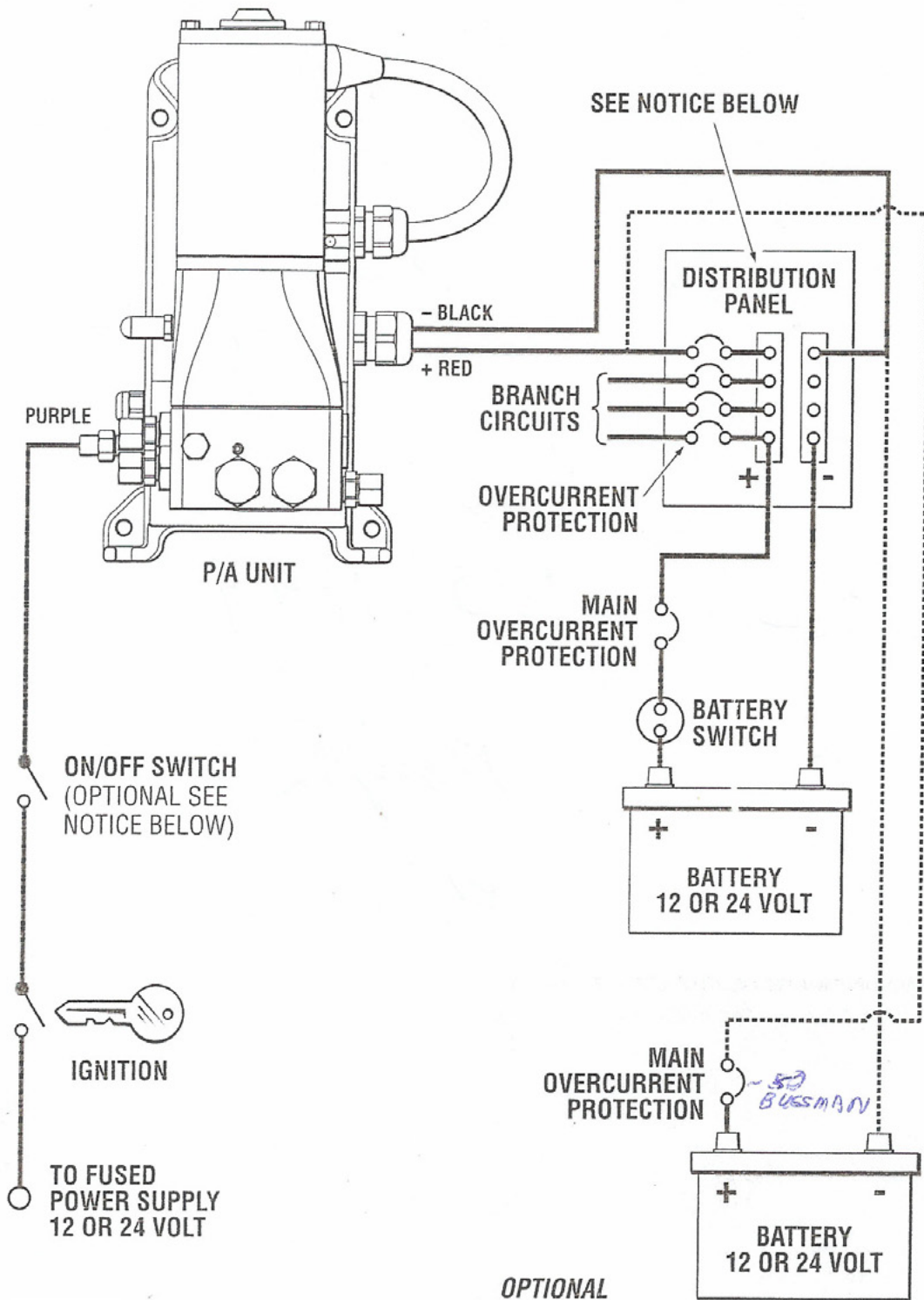

## Additional Outboard System Checks

Check these components/systems before starting engine:

1. Tilt the outboard drive and check the propeller for nicks and bent blades which will cause vibration.
2. While the outboard drive is tilted up check for any debris around the water intakes on the vertical drive shaft housing. These could cause the engine to overheat.
3. Check steering system fasteners at the engine and all related hydraulic hoses and connections for signs of leaks including the ones under the helm.
4. While the shroud is off check for any engine oil leakage or fuel puddling.
5. Check engine transom mounting fasteners for tightness.
6. Repair any signs of leakage and loose fasteners and hoses before attempting to start the engine.
7. Ensure that you use the 1/3 rule for determining if you have adequate supplies for the trip. Fill up as needed,
8. Check all throttle and shift cable linkages at power head for tightness.
9. When finished, reinstall the engine shroud ensuring all lock levers are secure.

## Flushing Engine Out Of Water

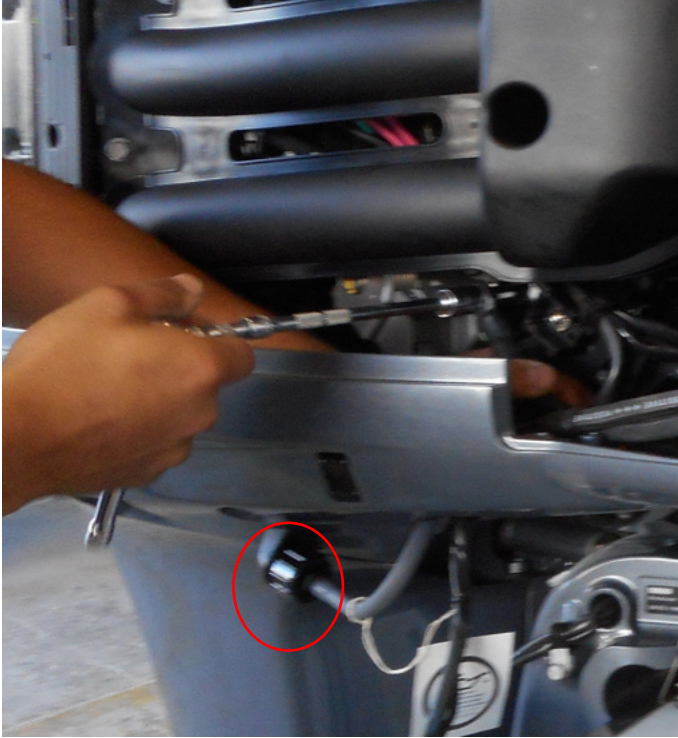

SEE FLUSHING DEVICE ABOVE CIRCLED

Your outboard may feature a flushing device which when connected to a garden hose circulates fresh water through the engine to purge unwanted debris such as found in salty, brackish, and silty water.

To use open the flushing device by turning it counterclockwise. Notice there is a garden hose bib thread. Attach the male end of a garden hose to the fitting and tighten it. Make sure the fitting does not leak as the power head could overheat and cause internal damage. It is best to perform this flushing procedure with the engine still warm from a cruise as the thermostat will be open and will permit more efficient water circulation. Turn on the fresh water supply. When flushing completed remove the garden hose from the fitting and reattach the hose connections and of course check for tightness.

Note that flushing devices that attach to the water intake area of the vertical drive housing can be used with a garden hose to flush the power head. When the water is turned on at the faucet the engine can be started and ran at idle.

These devices also called flushettes can be purchased at marinas, marine speciality stores or can be ordered through the outboard manufacturer. They can be useful for off season fogging of the power head or starting up the engine out of water. Contact your closest Regal dealer or marine professional for further information and instructions.

## Outboard Storage/Winterization

Your outboard has various detailed systems that are affected by extended storage periods. These systems require professional maintenance to protect the components from extended out of use periods especially in freezing climates.

See storage/winterization information in your manufacturer's outboard owner's manual for a listing of maintenance items.

We recommend leaving storage/winterization endeavors to your closest Regal dealer or marine professional. They have the special equipment, parts, lubricants and technical knowledge to perform these procedures correctly the first time.



# Chapter 6

## Vessel Operation

### Getting Underway

#### Pre-departure Questionnaire

*Note that your vessel may not have all the systems or equipment installed.*

- Is the fuel tank full?
- Is all safety equipment accounted for and easily accessible?
- Are navigation lights and horn operating properly?
- Is the bilge free of water and does the bilge pump operate?
- Is the engine and propeller in good working condition?
- Is the drain plug in place ?
- Have all passengers been briefed on emergency procedures and seated for departure? Is the boat load balanced?
- Is the operator sober, alert and ready to skipper the vessel?
- Have all passengers been fitted for life jackets?
- Has a float plan been filed and left with a competent person?
- Has the bilge been sniffed and the fuel system leak checked?
- Are sea cocks open (if applicable)?
- Is all communication equipment in good operating condition?
- Has a second person been briefed on operational procedures should the skipper become disabled?
- Are all gauges and electrical switches functioning properly?
- Has weather information been gathered and analyzed?

#### Underway Questionnaire

- After casting off have all dock lines and fenders been stowed?
- Are all passengers seated and all doors closed and latched?
- As skipper are you monitoring the dash gauges and/or Garmin plotter for changes?
- As skipper are you on the lookout for changing weather?
- Is the remote control safety lanyard tightly secured to your belt or clothing?

## Disembarking Questionnaire

Have you removed the keys from the ignition and secured them?

- Have all systems been checked for leaks?
- Has the battery switch been turned to the “off” position?
- Are all sea cocks closed (if applicable)?
- Has the fuel tank been filled enough to prevent condensation?
- Is the vessel properly tied and covered with equipment stored?

## Fueling

 **DANGER**

AVOID SERIOUS INJURY OR DEATH!  
GASOLINE IS HIGHLY FLAMMABLE  
AND EXPLOSIVE MATERIAL.  
PRACTICE “NO SMOKING” AND EXTINGUISH  
ALL FLAMMABLE MATERIALS  
WITHIN 75 FEET  
OF THE FUEL DOCK

 **WARNING**

AVOID INJURY OR DEATH FROM FIRE  
OR EXPLOSION  
RESULTING FROM LEAKING FUEL!  
INSPECT ENTIRE FUEL SYSTEM AT  
LEAST ONCE PER YEAR.

 **WARNING**

SINCE GASOLINE IS AVAILABLE  
IN SEVERAL GRADES  
INCLUDING ETHANOL AND VARIOUS  
OCTANE LEVELS, REFER TO THE ENGINE  
MANUFACTURER'S OWNER'S MANUAL FOR THE  
CORRECT GAS TYPE/GRADE.  
USING THE IMPROPER OCTANE LEVEL  
OR THE WRONG GASOLINE TYPE CAN CAUSE  
ENGINE DAMAGE AND VOID THE WARRANTY!

## Before Fueling

- Make sure a working fire extinguisher is available.
- Stop engines and any device that can cause a spark.
- Disembark all passengers and crew not needed for fueling.
- Fuel if possible during the daylight hours.
- Check to ensure nobody is smoking in the boat or near the fueling dock.
- Close all portholes, hatches and doors to keep vapors from blowing aboard and settling in the bilge.
- Tie up your boat securely at the fuel dock.
- Identify the fuel fill. Unfortunately, people have mistakenly filled the water or waste with fuel.
- Visually inspect all fuel system components before each filling.
- Avoid using fuels with E-15 alcohol additives. It can attack fuel system parts along with hoses and cause deterioration.

## During Fueling

- Keep the fuel nozzle in contact with the fuel fill to guard against static sparks. The fuel fill pipe is grounded through the fuel system wiring to protect against static electricity.
- Avoid overfilling the fuel tank. Leave room for expansion. Also, if fuel exits the fuel vent indicating the tank is full, this situation is dangerous and unfriendly to the environment.
- Avoid spilling any fuel. Clean up any fuel accidentally spilled with a clean rag and dispose of it on shore.

## After Fueling

- Close all fuel fill openings tightly.
- Open all portholes, hatches and doors if applicable.
- Sniff in the bilge and engine area for gas fumes. If fumes are detected continue to let the area ventilate until the odor is gone. Look for any traces of fuel droplets or spillage. Do not start the engine(s), smoke or run any electrical components until the fumes can no longer be detected.

Strong Points- Read Warning Below

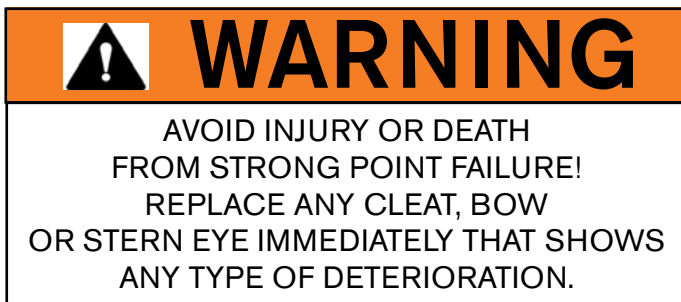

## Dock Line Basics

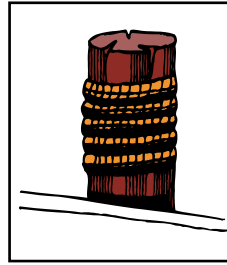

Most skippers use dock line terminology fairly loose but there is more to the basics than just bow or stern lines. There are several lines that can be secured to the bow and stern and depending on their direction and use, can be called other names. Remember that “forward” and “aft” refer to the direction that a spring line runs from the vessel, and not where it is secured on board.

### Bow/Stern Lines

There is only one true bow line. It is secured to the forward cleat and run forward along the dock to prevent the vessel from moving to the stern. The stern line leads from a rear cleat to a piling or cleat on the dock astern of the vessel. This line keeps the boat from moving ahead. For small vessels these are the only lines needed for normal wind and current conditions. If located in a tidal environment, keep slack in the lines.

### Breast Lines

These lines are attached to the bow and stern that lead to nearly right angles from the center of the vessel to the dock. They help keep larger vessels from moving away from the dock, or are pulled in to help people board the vessel. Larger vessels may use bow or quarter breast lines.

## Spring Lines

Most small boats use two spring lines although it is possible to have four. They are called the after bow spring and forward quarter spring.

Bow springs are secured at the vessels bow area. Forward spring lines lead forward from the boat to the dock and control movement toward the stern. After springs stem aft from the vessel, and stop movement ahead. Spring lines are used to prevent movement in a berth, ahead or astern. They are really useful in controlling the effects of a real active tidal surge. Spring lines are useful where fenders need to be kept in place against piles.

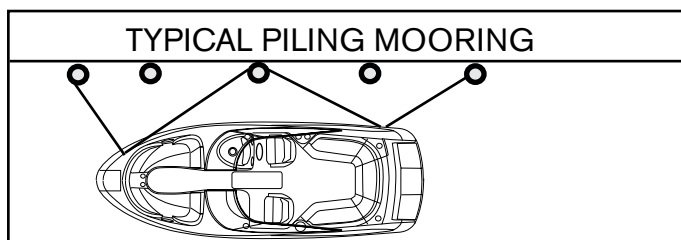
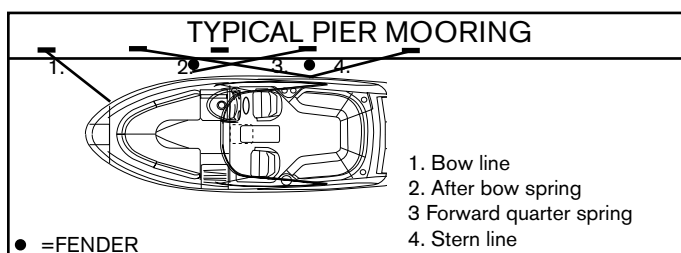

## Boat Mooring

Most boats can be secured to a dock using four lines. The after bow spring is crossed with the forward quarter spring and secured to individual dock cleats or pilings. This ensures longer springs and can be snugged up tighter for more efficient tidal control.

Remember, if you only have one piling available, position the vessel so this point is opposite amidships. Run both spring lines to it. These lines will be shorter but still useful. The bow and stern lines should be relatively at a 45 degree angle with the dock. The stern line can be attached to the near-shore quarter cleat, but will work more efficiently to the offshore quarter cleat. The longer line will allow the boat flow with the tide with less time checking the vessel.

## Dock Line Sizing

Most dock lines today are made of nylon, either of twisted rope or braided core and cover. The most often used material is nylon because of its stretching abilities absorbing shock loads. It is chafe resistant for extended life and is easier on bare hands.

The line's size varies with the vessel. Normally, a vessel in the 20' to 40' boats will use 1/2" diameter nylon lines. Larger yachts use 5/8" and 3/4" diameter nylon lines. Smaller boats can use 3/8" nylon lines.

Dock lines need to have the strength to hold the vessel and have enough density to resist chafing. They shouldn't be too heavy that they lose their shock-absorbing capabilities. Use the right size line for the vessel since a line too large for the boat will pull hard against the vessel since it won't be forced to stretch. If the line is too small for the vessel, there is no margin for wear and chafe when under strain.

## Securing Dock Lines

When mooring your boat, make sure the dock lines are secured at both ends. Depending on your situation you may need to loop the eye splice of the dock line around a piling.

Sometimes the mooring line will lead down sharply from the piling to the deck cleat. Loop the eye splice around the piling twice to keep it from being pulled up off the pile.

Pull the line through the looped eye if the mooring line is too small to go around the piling twice or too small to fit over once.

If you must drop a line over a piling that already holds another boat's line, run the eye of the line up through the first eye from below, then loop it over the pile. This will allow either line to be removed without disturbing the other. If another line is dropped over yours, simply reverse the process. Secure a little slack in the other dock line, then slip your eye up through its loop and over the top of the pile. Your line can be dropped through the other eye.

When debarking from a dock, it is easier to release the line from a cleat or piling, from on board the boat, as soon as you leave the dock. Loop a long line around the cleat or pier and leading both ends on board you can release the line easily. Slip one end around the cleat or pile, then pull it back on board. Release the line without the eye splice, so it will run freely from around the pile without hanging up on the splice.

## Fenders

Fenders are normally made of a rubberized plastic and are usually filled with air. Most have a fitting like a basketball so they can be inflated or deflated. Fenders are available in a wide range of sizes and shapes to fit both small and large vessels. Fenders are normally designated in inches. They are used between piers, docks, sea walls and the boat.

They protect the top sides of the boat from rubbing against rough objects. Most fenders have eyes of attachment which allow a line to be inserted vertically or horizontally. This will permit the fender to be tied off to fit a variety of marina, dock and tidal situations. Be sure the fender is correct for the vessel size. It is a good idea to carry extra fenders but half a dozen is normally an acceptable number. Remember to store fenders on board so they can be easily accessed. Some people incorrectly call fenders "bumpers".

Note that optional fender clips may be optional for your vessel.



There is a variety of fender styles and types, each selected for specified uses. When choosing fenders, contact a marine dealer or supply house. Explain how you moor and use your vessel so they can recommend the best fender type for you. We suggest the type with a fill plug so you can inflate them with a hand pump like the ones used for bicycles.

## Stern Drive Maneuvering

Directing propeller energy (thrust) makes slower speed maneuvering easier. The propeller discharge current is turned from one side to the other which results in turning forces. Rudder boats need water to flow by the rudder to be efficient. Stern drive units are designed to have reduced shaft angle, so the propeller does not produce as much unequal blade thrust and resistance. Large horsepower boats do produce more thrust and steering torque but your vessel has the advantage of a "fly by wire" steering.



Below is some basic information on how stern drive boats handle in normal conditions.

### Gathering Headway

When a stern drive is not moving forward or reverse in the water and the propeller is not turning, (shift in neutral) the boat will not react to the helm steering wheel.

As soon as the vessel is shifted into forward gear propeller action creates a discharge motion and generates energy in the form of thrust. If the drive is centered, the discharge motion is directed straight back causing the vessel to advance forward.

You may notice that if you advance the throttle quickly in initial take-off (make sure you have a firm grip on the wheel), the boat has a tendency to pull the stern of the vessel to starboard. There is a trim tab (also serves as a sacrificial anode) located on the drive housing. This trim tab helps compensate for the low speed steering torque. Once the boat increases headway and the propeller is operating in a faster water flow this torque effect decreases.

Sometimes the trim tab may need adjustment. Contact your Regal dealer for further information or consult your engine manufacturer's manual.

### Turning

Once the boat has gathered headway, with the boat planing at the correct bow angle and the outboard drive unit and helm straight the boat tends to stay on a uniform course heading. To assure the boat trim angle is correct use the chart plotter screen trim gauge as a guide while activating the trim button on the remote control panel.

When the helm wheel is turned to the right or starboard, the drive unit is turned in the same direction. The propeller's discharge force is directed to starboard forcing the boat's stern to port. Water flowing past the hull strikes the stern drive gear housing in its starboard side, creating additional turning torque. The stern starts a move to port, forcing the bow to starboard.

If the helm is turned to the left or port the drive turns to port, the stern of the boat goes starboard as the bow turns to port.

As the vessel operator gains experience, he will better gauge each maneuver and speed situation. In this way he will understand the handling characteristics of his boat. He needs to keep the safety of his passengers in the highest priority.

### Backing Down

If your boat has the steering wheel and drive straight with the control in reverse, the stern will be pushed a bit to port by the reversing propeller thrust. This tendency to back to port can be eliminated by turning the drive to starboard.

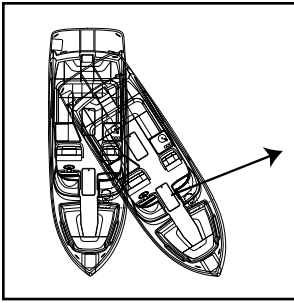

When the vessel begins to gather speed to stern, the water passing by the lower gear case housing will continue to increase steering torque. If the helm wheel is turned to

starboard, and will direct the propeller thrust to port, tracking the stern to starboard.

Wind and current will affect how a vessel backs. Stern drive boats tend to be light displacements and when backing down in a strong crosswind, the bow will tend to fall toward the windward. This may cause steering problems.

## Stopping

Remember that your boat does not have any brakes. It uses reverse thrust from the propellers to stop. If the vessel has headway, with the helm and propeller in reverse the propeller thrust is directed backwards, past the lower gear case. Depending on how far the throttle is advanced, the discharged thrust may not be strong enough to reverse the water flowing by the gear case. As the power is increased, the propeller thrust becomes strong enough to stop the flow of water past the lower unit, and, as the throttle is advanced it reverses its flow more completely.

When water is flowing past the gear case, steering torque is increased, but when the thrust stops the water flow, the boat will not respond to the helm. This is a short lived event and is overcome quickly when the water again flows past the gear case. Furthermore, added to the energy of the water hitting the lower gear case, the propeller thrust is directed by turning the stern drive unit which can add to the steering torque.

The prop tends to throw the stern to port. This is why experienced skippers undertake a port side landing when wind and current conditions permit. They allow the prop to move the stern to port toward the dock. With a forward motion when the helm wheel is turned hard to one side, the vessel pivots around a point about 1/3 its length abaft to stern.

## Power Trim

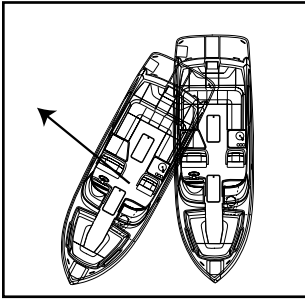

Stern drive boats have the ability to angle in or out their drive unit in relationship to the transom. This is accomplished by hydraulic shocks located on the lower unit housing along with an electrical trim pump and sender unit that reads the drive angle and sends information to the chart plotter showing a reading.

### Purpose of Power Trim

The purpose of the power trim/tilt is to enable the operator to change the angle of the drive while at the helm. Changing the angle of the drive or “trimming” provides the following benefits:

1. Improves acceleration onto a plane.
2. Maintains boat on plane at reduced throttle settings.
3. Increases fuel economy.
4. Provides smoother ride in choppy water.
5. Increases top speed.

In short, it is a way of fine-tuning the performance of your boat and will enable you to get the most efficient and comfortable ride possible.

### Using Power Trim

The power trim is normally used prior to accelerating onto a plane, after reaching the desired RPM or boat speed and when there is a change in water or boating conditions.

Position passengers and equipment in the boat so that the weight is balanced correctly fore and aft as well as side to side. Trimming will not compensate for an unbalanced load.

To operate the trim, push the switch until the desired bow position is reached. The trim may be operated at any boat speed or at rest. Avoid operating the trim system when running in reverse. Observe the trim/tilt gauge which indicates the boat's bow position achieved by the trim angle of the vertical drive unit. “Bow-Up” corresponds to the upper portion of the trim range on the gauge while “Bow Down” corresponds to the lower portion of the trim range on the gauge.

To determine the proper trim angle, experiment a little until you are familiar with the changes in your boat. The vessel will be properly trimmed when the trim angle provides the best boat performance for the particular operating conditions. A trim position that provides a balanced steering load is desirable. To familiarize yourself with the power trim, make test runs at slower speeds and at various trim positions to see the effect of trimming. Note the time it takes for the boat to plane. View the chart plotter screen, tachometer and speedometer readings as well as the ride action of the boat.

### Operation In “Bow Up”

The “Bow Up” or out position is normally used for cruising, running with a choppy wave condition, or running at full speed. Excessive “bow up” trim will cause propeller ventilation resulting in propeller slippage. Use caution when operating in rough water or crossing another boat's wake.

Excessive “bow up” trim may result in the boat’s bow rising rapidly, creating a hazardous condition.

#### Operation In “Bow Down” Position

The “Bow Down” or in position is normally used for acceleration onto a plane, operating at slow planning speeds, and running against a choppy wave condition. It is also used when pulling water skiers, tubers, knee boarders, etc. In this position the boats’ bow will want to go deeper into the water. If the boat is operated at high speed and/or against high waves, the bow of the boat will plow into the water.

#### Operation In ‘Level’ Position”

In normal running conditions, distribute passengers and gear so boat is level. At or below cruising speeds, trim the vessel for optimum performance. The trim gauge will show somewhere in the center of the gauge. This position will also enhance running visibility and overall stability. Again, each outing provides different wave, load and running conditions. Be prepared to make trim changes as needed.

	<b>CAUTION</b>
<p>THE BOAT TRIM SHOULD BE ADJUSTED TO PROVIDE BALANCED STEERING AS SOON AS POSSIBLE EACH TIME YOU GET UNDERWAY. SOME BOAT/ENGINE/ PROPELLER COMBINATIONS MAY CREATE BOAT INSTABILITY AND/OR HIGH STEERING TORQUE WHEN OPERATED AT OR NEAR THE LIMITS OF THE “BOW UP”OR “BOW DOWN” POSITIONS. BOAT STABILITY AND STEERING TORQUE CAN ALSO VARY DUE TO CHANGING WATER CONDITIONS. IF YOU EXPERIENCE BOAT INSTABILITY OR HIGH STEERING TORQUE SEE YOUR AUTHORIZED REGAL DEALER.</p>	

#### Shallow Water Operation

Operating your vessel in shallow water presents various hazards. You are more apt to hit a submerged object such as a rock, sand bar, stump coral, or other unmarked objects.

Pay close attention to your chart plotter for descriptions of any shallow areas along with marked submerged objects. Always post a lookout when operating in shallow water. Trim your drive up as needed to provide adequate draft. If possible, set the alarm on your depth sounder and travel at a speed that will keep the boat level in these shallow areas.

**Note that if your boat strikes a submerged object stop immediately and check for hull, drive, and propeller damage.**

## TRIMMED "TO FAR IN" POSITION



## TRIMMED "TOO FAR OUT" POSITION



## WELL TRIMMED "LEVEL" POSITION

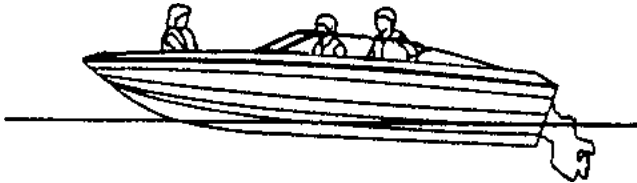

Typical Examples (Stern drive shown)

*Note on various outboard models power trim is part of the standard outboard equipment. Trim tabs which attached to the transom may not be installed or available on some outboard models.*

## Anchoring

Selecting the correct anchor is an important decision. The anchor style in part depends on the usage and boat type. Regal may designate an anchor type and or model. Some models incorporate chain, line with an optional windlass. Contact an authorized Regal dealer for more information.

Anchoring is easier with another person on board. First be certain that the line for the anchor is properly attached, to avoid losing the anchor and anchor line overboard.

For most anchors to perform more efficiently, you should attach 3 to 6 feet of chain. The chain will stand up to the abrasion of sand, rock, or mud on the bottom much better than a nylon line. It should be galvanized to reduce corrosion. Next, attach a length of nylon line to the other end of the chain.

The nylon will stretch under a heavy strain cushioning the impact of waves or wind on both the boat and the anchor.

To anchor, select a well protected area, preferably with a flat bottom. Contrary to modern belief, you do not throw the anchor over while the boat is making headway, or moving forward. In fact, the bow of the boat should be brought slowly backward, while easing the anchor slowly over the side of the boat until it hits the bottom. To "snub the line" means to stop its outward "pay" or movement. Usually the length of anchor line used should be 5 to 10 times the depth of the water.

After you have anchored, check your position with landmarks if possible. You need to continue to monitor landmarks to make sure you are not drifting.



Since anchoring can also be an emergency procedure, the anchor and line should be readily accessible.

For increased holding power in windy conditions, two anchors are sometimes set. If your primary anchor drags, you can run out your secondary anchor without picking up the primary one. The important thing is to lay them out at an angle. When setting two anchors, make sure they are fastened to separate rodes or cleats. This is done in case you need to adjust one later so the line is accessible. If two anchors are used ahead of a boat, make sure to set the rodes at an angle than in a straight line to reduce the chances of tangling as the boat moves in wind and current. See the illustration.

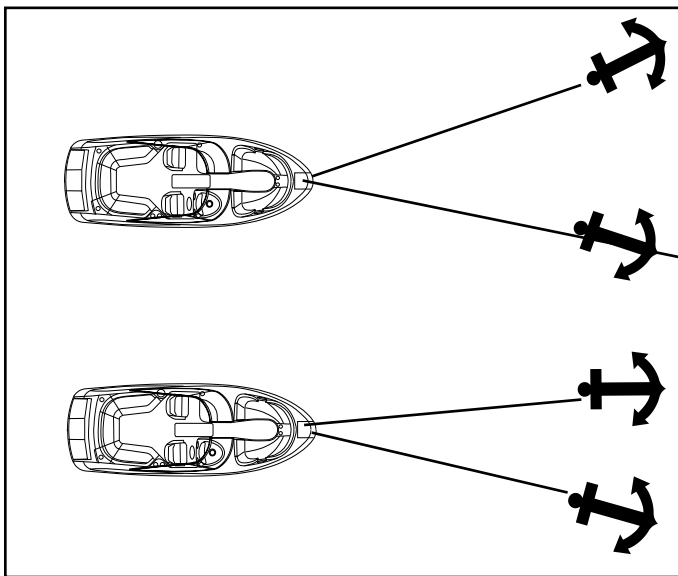

### The Law Of Salvage

The Admiralty law sometimes referred to as the salvage law was founded primarily on English law fundamentals and basically says that a vessel distressed, in danger of flounder, if rendered assistance from a towing company or private agency, can be forced to relinquish a portion of the vessels' worth for the assistance received.

# NOTICE

IN THE EVENT  
YOUR VESSEL IS IN DISTRESS,  
PRIOR TO ALLOWING ANY TOWING  
COMPANY OR PRIVATE AGENCY THE  
RIGHT TO PASS A LINE TO YOUR VESSEL,  
BE SURE TO ESTABLISH THAT YOU  
DO NOT AGREE TO SALVAGE RIGHTS.  
ESTABLISH WITH THE CAPTAIN  
OR OPERATOR THAT YOU WISH TO BE  
ASSISTED IN A CONTRACT BASIS AND  
ESTABLISH A PRICE.  
OF COURSE IN CERTAIN SITUATIONS, YOU  
MAY NOT HAVE THIS OPTION.

USE YOUR BEST JUDGEMENT!

### Towing

Read and understand the above notice! In case you find yourself aground or in need of a tow, or should you want to tow another vessel, keep in mind that you never use deck hardware or cleats to secure lines for towing!

Deck hardware is intended for mooring and anchoring, and is not designed to withstand the strain and pull of towing. Rather than tie the line to your cleats on deck, it is suggested that you tie a bridle by passing a line completely around the hull of your boat to avoid damage.

When towing, always stand clear of a taut line, as any type of line breaking under stress can be extremely dangerous. The preferred line for towing is double-braided nylon, as it has sufficient elasticity to cushion shock loads. Move slowly and cautiously.



# WARNING

AVOID INJURY OR DEATH!  
DO NOT USE DECK HARDWARE  
INCLUDING CLEATS  
FOR TOWING.

## Knots

Knots are useful in docking, towing and other emergency situations. Learning to tie knots requires practice. As they say “ Practice makes perfect”. Some of the knots used in boating are the square, bowline, anchor bend, clove hitch, figure eight and half hitch. There are several periodicals available that explain various knots and how to tie them effectively. An experienced skipper will know the basic nautical knots and will use them when on the water. Take the time to know the basic knots.

**Figure 8 Knot  
Tied To Cleat**



A useful knot to learn for general docking is the figure eight with one end reversed. By turning the free end of the line back under, the knot can be released without disturbing the boat. After some practice one person can secure a vessel easily to a dock or pier in a variety of weather conditions. This knot normally is used to tie the bow and stern. Then the vessel can further be fastened by tying the spring line in the figure eight knot. Wrap it around the cleat 2 or 3 times.

## Emergencies

Always be ready to help others on the water if possible, but do not take any unnecessary risks. Use equipment to save a life, but do not risk a life to save equipment. Consult earlier information in this manual concerning accidents, etc. Also, read other literature concerning on the water emergencies. Be alert and prepared!

## Fires

Fire aboard a vessel can spread quickly and can cause tremendous alarm among everyone. Most fires can be prevented by keeping the bilge free from oil and debris. Keep all equipment stowed and maintained in working order. Carry a backup fire extinguisher on board. If something becomes a possible fire hazard, remove that possibility at once. Never use water on gasoline, oil or electrical fires. When you dump water on an electrical fire you can be shocked since water conducts electricity.

Follow these instructions if a fire breaks out:

- A. Fit everyone aboard with a life jacket. Turn off the ignition.
- B. Try to keep the fire downwind. If the fire is to the stern, head the bow toward the wind. If forward, put the stern to the wind.
- C. If the engine should catch fire, shut off the fuel supply. Usually there is a fuel tank access that will enable you can crimp the fuel feed line.

D. Use a hand fire extinguisher. Make sure to point it at the base of the flames. Use short bursts and sweep the extinguisher side to side.

**Remember : (4 lb. extinguisher discharges in 20 seconds)**

These actions help prevent the fire from spreading to other parts of the boat. You can extinguish fires quickly if you act swiftly. Have a plan of action in motion in case a fire breaks out.

## First Aid

Knowing first aid can save lives. A first aid kit and the ability to use it are important ingredients for the safety of a skippers' passengers, crew and vessel. Having confidence and competence in handling medical emergencies on board is a must for the skipper. Invest your time in a first aid course available at the American Red Cross.

## CPR (Basic Life Support)

If someone is seriously injured have someone call for help while the injured person is being attended.

Check for possible danger signs; loss of breathing, unconsciousness, severe bleeding and heartbeat. If you determine the individual is not breathing or unconscious place the victim on their back on a hard surface and do the following:

1. If unconscious, open the airway. Neck lift, head lift or chin head lift.

2. If not breathing, begin artificial breathing. Pinch the nose. Give 4 quick breaths. If airway is blocked, try back blows, abdominal or chest thrusts and finger probe until airway is open.

3. Check for pulse. Begin artificial circulation. Depress sternum 2".

15 compressions rate 80 per minute. 2 quick breaths. Continue uninterrupted until advanced medical support is available.

## **Follow up immediately with medical authorities!**

## Hypothermia

Hypothermia is a condition where the body temperature decreases because the body can't generate enough heat to maintain its normal temperature. It can be serious and usually occurs where victims have been immersed in water (under 68 degrees) for extended periods of time. If you encounter a possible hypothermia victim call for help on the radio and get the person out of the water.

Symptoms are:

1. Shivering that if condition is advanced may stop.
2. Confusion, clumsiness or slurred speech.
3. Rigid muscles.
4. Semiconscious to unconscious.

Treat hypothermia by the following:

- Remove wet clothing.

- Monitor the victim's pulse and breathing.
- Rapidly apply heat to the body core by using blankets, naked bodies or warm water.
- Do not give the person any food or drink.
- Do not warm the arms and legs. Warming of these extremities can be fatal. Follow up immediately with medical authorities!

### Electric Shock Drowning (ESD)

ESD occurs when stray AC current enters the water either from marina or private docks and/or open grounding conductors on vessels. People caught in this dangerous electrical field in the water often drown as the body becomes paralyzed. ESD happens much more often in fresh or brackish water as salt water tends to conduct electricity and basically grounds it.

To aid in prevention of ESD do the following:

1. Never swim near a marina, dock, or boat yard or near a boat especially if it is running.
2. When in the water stay at least 150 feet away from boats or docks where electricity exists.
3. Always obey "no swimming signs."
4. If your vessel features a battery charger use a 3 prong electrical cord rated for the battery charger receptacle. Plug the male end into a functioning shore system GFCI. Do not let the cord dangle in the water. Allow for cord slack if in tidal zone.
5. Check with marina owner to ensure his electrical system has been recently inspected and up to code.
6. Yearly have a qualified marine electrician inspect your vessels electrical system.

### Environmental Awareness

There are numerous vessels operating on our waterways on a daily basis. Each boat has an impact on our environment. Boat operation habits, marine sanitation, and maintenance all play a role in a delicate battle to keep the ecosystem clean. Each of us has a role in doing our part as an environmentally conscious skipper to conserve our waterways.

The National Marine Manufacturer's Association lists their top ten of Eco-Boating Practices as follows:

1. Observe all regulatory agency policies regarding marine toilets.
2. If equipped with a holding tank, use marina pump-out facilities.
3. If used, make sure bottom paints are legal and ecosystem friendly.
4. Use only biodegradable cleaning agents.
5. Dispose of all garbage and litter on shore properly.
6. Don't top off fuel tanks. Leave expansion room. Clean up spills.
7. Watch your wake and propeller wash.
8. Make sure your engines are well maintained.
9. Control your bilge water.
10. When fishing, practice the "catch and release" principle.

**Follow these basics practices when on the waterways. Treat the environment in a way that you would like to be treated.**

## Aquatic Invasive Species (AIS)

Aquatic Invasive Species (AIS) are animals and plants that are found in waters in which they are not native and whose introduction is likely to cause environmental or economic harm to human health. AIS have a minus effect on our waterway, related species along with commercial and recreational uses of the waterway.

Each boat owner and citizen alike should do their part to prevent the spread of these aquatic “hitchhikers”. In many locals it is required by law so check regulation in each and every waterway you intend to boat.

After each boating trip follow the three simple steps below to stop the AIS spread: Clean, Drain and Dry. Being that the spread of AIS can damage the environment you as a boater can use the three steps above to help protect it.

### Clean

Do a visual inspection and remove all aquatic animals, plants, debris and soil from the boat, engine, trailer, water toys and anchor/line. Scrub, wash or rinse away from ditches and waterways.

### Drain

Drain completely all water from the vessel including all its compartments including lockers, bilge, wells, ballast bags, bait containers, engines and stern drives.

## Dry

After draining all water ensure that the boat dries completely before taking the craft to other waterways.

*Note that select localities may require decontamination or inspection before and/or after launching your vessel. Be sure to check local and state laws and regulations for particular requirements prior to traveling to a boating waterway.*



# Chapter 7

## Auxiliary Equipment Operation

### Overview

This chapter will assist the boat operator in understanding selected standard and optional equipment components on the vessel. **Select equipment described may not be installed on your boat or the pictorials and/or instructions may not exactly fit equipment on your craft.** Remember that Regal is constantly improving its product line and therefore may make changes in vendor parts and specifications without notice. For detailed information on equipment, please refer to the owner's information packet.

### Fire port



Stern drives feature a fire port located close to the engine hatch. If a sump fire is suspected a plastic plate built into the port enables you to visually inspect the engine compartment without opening it and adding oxygen to the fire. In a fire emergency break the fire port plastic plate with the portable fire extinguisher nozzle, place the fire extinguisher positioned as vertically as possible in the port and pull the pin on the extinguisher to discharge the contents. Do not open the engine hatch until the fire is out and metal parts are cooled down. The preferred portable extinguisher is a clean agent type such as the Halotron 1 as it removes the oxygen from the area which a fire needs to exist and grow. Look for a portable that is EPA approved and with no residue after use.

### Automatic Fire Extinguishing System



Stern drive engines use a powered ventilation (blower) system and may have installed an optional fire extinguishing system in the sump capable of automatic and manual activation. The dash monitor utilizes an instrument display unit light that provides the operator with a system status of a charged or

uncharged condition by an audible alarm and icons. With the ignition switch on and a no light condition it indicates that the system has been discharged.



If the fire extinguishing system should discharge the ignition system will be instantaneously interrupted and the engine will shut down. See the automatic fire

extinguisher manual in the owner's packet.

## Automatic Fire Extinguishing System Cont.



If a fire has started in the engine compartment the system will automatically discharge or the operator can manually discharge the extinguisher. Find the system manual cable assembly located in the cockpit. To use the manual remote remove the safety pin from the

“Fire T Handle” and pull firmly on the “Fire” handle which will activate the fire extinguisher unit in the engine compartment. A loud “rushing air” sound may be heard. Complete discharge will take several seconds. Keep the compartment closed for a period of time sufficient to permit the agent to soak all areas of the protected space. This allows hot metals and fuel time to cool. Refer to the automatic fire extinguisher owner’s manual for additional information.

*Note: The boat operator needs to educate the crew on fire protection and more specifically the automatic fire extinguishing system in the event that he becomes incapacitated. It is a good idea to practice by having a mock fire drill.*

## Portable Fire Extinguishers

Clean agent extinguishers are primarily for Class B and C fires (gasoline is a flammable liquid under the Class B group). The extinguisher should be of the 5 lb. capacity and 2 are recommended based on the maximum capacity of the fuel tank onboard and the boat length. These extinguishers may be available from your dealer, marine speciality stores, or on the internet. It is recommended to have extra portable fire extinguishers to backup the automatic fire extinguisher system since a fire could take place in an area outside of the sump/ machinery space.

As noted above a clean agent type of liquefied gas used today is FE- 241. This gas is colorless and odorless, heavier than air and sinks to the lower parts of the sump to extinguish fires. Since the year 2000 ingredients have changed to a more environmental friendly formula (Chlorotetrafluoroethane or FE- 241). FE- 241 is used in portable-hand units.

The canister needs to be weighed once a year. Also, the canister is engraved with a date which is part of the canister life cycle. Refer to the information regarding fire prevention in this manual and on the internet.

Normally the clean agent fire extinguishers cost more than powdered or CO<sub>2</sub> extinguishers and they are more effective with fire ports than powder extinguishers. They work by suffocating the fire by removing the oxygen which is a key factor in any fire.

## Bilge Pump

Before each outing, check the operation of the bilge pump, automatic switch, and manual switch. The bilge pump should automatically activate when water reaches a pre-determined height in the engine compartment. Test the bilge pump manually at the dashboard with the switch. Periodically check for bilge debris around the grates of both the bilge pump and automatic switch.

The automatic mode for your bilge pump works similarly to the manual method. Both methods control the bilge pump by a switch, but the automatic mode utilizes a float switch. Float switches use a device that sits at water level, and when the float reaches a certain height, it trips the switch and activates the bilge pump.

Periodically you may need to disassemble the bilge pump from the grate in order to clean or access the inner mechanisms. To remove the bilge pump, utilize the quick disconnect tabs on either side of the bilge pump, squeezing them like a backpack clip while pulling up on the pump.

The bilge pump and float switch are normally located at the center hull bottom to the front of the engine. Once you open the engine hatch it should be easily seen. Refer to the vessel operations chapter for pre-departure use.

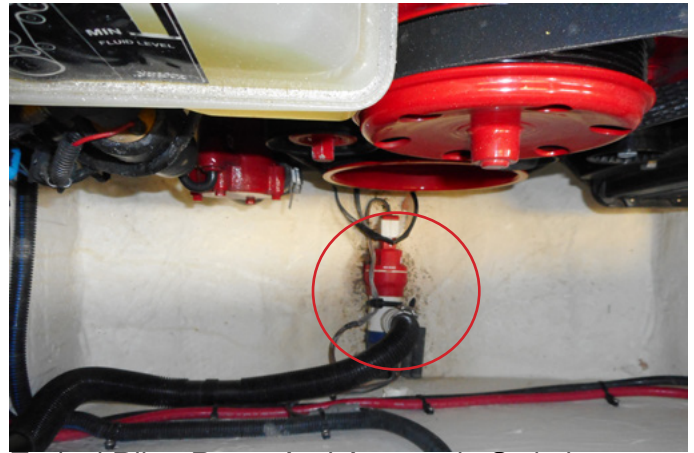

Typical Bilge Pump And Automatic Switch

## Bow Filler Cushion-Typical

Your vessel may include an optional bow filler cushion. To set up the filler cushion follow these steps:

1. Find the filler cushion which is stored in one of the bow storage compartments accessible by lifting the seat cushion.



2. Locate the support bars which normally are found in the bow storage compartment. Position shorter bar in the forward grooves. Position the longer bar in the aft grooves. See photo below.



1. Insert the hard back filler cushion in place and align as needed. This completes the installation.





## Bow Walk Through Doors

If installed the bow walk through doors provide a barrier for cockpit passengers in rough seas and wind gusts. They can also aid in colder climates as a blanket against lower air temperatures. Do use the doors follow these steps:

1. Pull the doors free from the magnetic catches and bring them near closing. Note the latch.

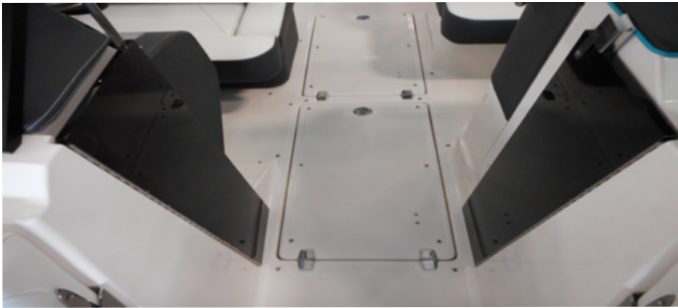

2. Lift the latch to clear both doors while bringing both doors to a closed position. Lower the hinged latch until it is completely down.

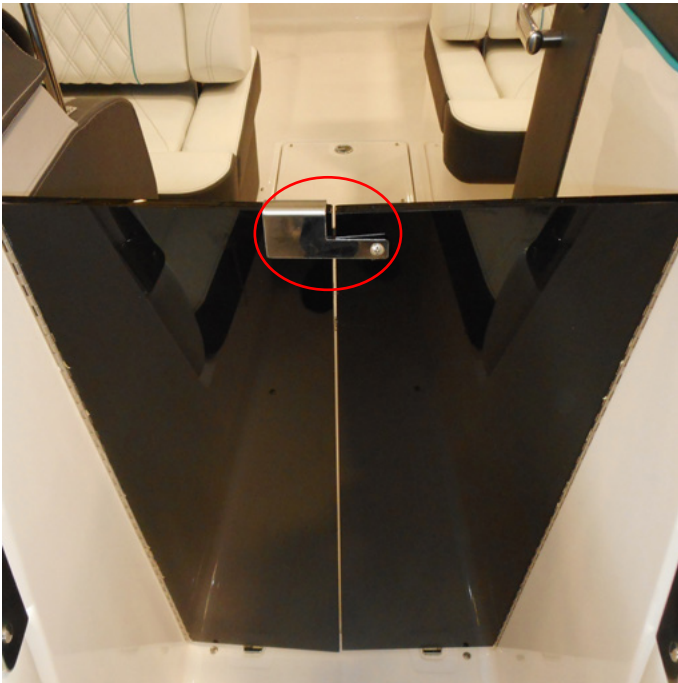

Note that these are acrylic doors and are tinted for UV protection. Clean with a soft cloth and mild soap. Rinse with plenty of water. Never use harsh chemicals or coarse cleaning implements or brushes. Periodically remove any scratches or dullness using products for acrylic. Buff with soft cloth o bring out the luster of the product.



## Canvas

There are canvas options available for your vessel including bow covers, cockpit covers, PowerTower and travel/storage covers. Let us look at the basic installation on each type. As general information many of our models use Sunbrella a solution dyed fabric well known for its ability to hold up in the harsh marine environment.

### Bow Cover

If installed a bow cover protects the front cockpit of the boat from weather and snaps to the deck. *Note that the bow cover is not be used for towing.* On select vessels when both the bow and cockpit cover options are purchased, the two halves snap and velcro together at the center windshield location.

Notice in the middle underside of your bow cover, you may find an area of reinforced canvas with an eyelet snap. This snap connects to a bow cover pole. This pole is adjustable and by opening the lock the pole can telescope out to the desired length. This pole should push the canvas up when positioned correctly on its rubber enclosed foot. The purpose here is to prevent the pooling of water.

### Cockpit Cover

If installed, the cockpit cover installs over the windshield and snaps to the deck. The cockpit cover is meant to protect the cockpit of the boat from weather elements. *The cockpit cover is not to be used for towing purposes.* Note that on the bow end of the cockpit cover, there may be a velcro strip used to attach to the bow cover.



This strip can be used to align the covers with your boat. Line up the Velcro edge with the windshield. Ensure the center windshield is in the closed position. Start snapping the cover to the deck by use of the eyelet snaps, starting at the bow and working aft. Continue snapping the cockpit cover to the deck snaps. When you reach the rear corner, leave enough room for an exit point. Notice in the middle underside of your cover, you may find an area of reinforced canvas with an eyelet snap. This snap connects to a cockpit cover pole. This pole is adjustable, and by opening the lock, the pole can telescope out to the desired length. This pole should push the canvas up when standing straight up on its rubber enclosed foot. Again, the purpose is to shed water off of the top.

The cockpit cover and bow cover should be rolled up for storage inside the ski locker when towing or storing your boat.

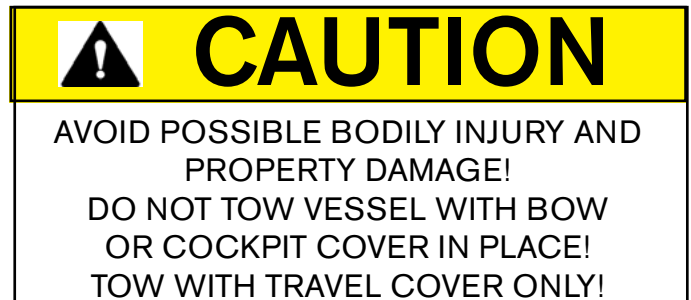

## Travel/Storage Cover- (Typical)



TYPICAL TRAVEL/STORAGE COVER



RATCHET STRAPS INSIDE POCKET



RATCHET STRAP LOCATION



## WARNING

AVOID BODILY INJURY!  
WHEN TIGHTENING UP RATCHETS  
KEEP HANDS AND FINGERS CLEAR  
OF ROTATING PARTS!

Ensure the ratchet strap located at the aft center of the cover or on the port and starboard sides is tight and any velcro flaps or zippered pockets are closed on the travel cover before pulling boat at highway speeds. Tie cover securely to bow and stern eyes. Once on the road periodically pull over and check cover, ratchet strap(s) and pertinent hardware for tightness. Note that select covers use dual aft straps.

*Note not exceed manufacturer's miles per hour speed limit. See travel cover information for additional details or visit them on their web-site.*



## INSTALLING TRAVEL/STORAGE COVER

**▲ WARNING:** To prevent damage to your boat and/or cover please read and understand instructions before attempting to use cover.

It features:

1. **ON SOME MODELS:** A special anti-pooling system is included to prevent large puddles from ruining your cover.
2. The SurLast® all-weather fabric was chosen to allow stability, water repellency and breathe-ability.
3. The Vacu-Hold™ system allows trailering at highway speeds (65 mph) without billowing or buffeting.
4. The new ratchet and drawstrap type attachment will allow easy, tight and secure installation.

### CARE, WARRANTY AND INSTALLATION INSTRUCTIONS

**Hint-**To properly install ratchet strap system.

1. Pull the webbing through the channeled ratchet cylinder and tension while ratcheting to "start" the webbing.
2. Tension the ratchet with about 5 lbs. of pressure (pinky finger). Pull the sides of the cover to even the webbing throughout. Re-tension about 5 lbs. (the ratchet should be tight on the side of the boat lever, perpendicular to the hull).
3. Crank the ratchet approximately 5 full additional times to add tension (based on an 18' boat).
4. Check boat webbing for tension during stops while trailering. (webbing may stretch during first installation and use CHECK OFTEN).

**▲WARNING:** Readjust and retighten the cover after trailering and before storage. To prevent pooling do not allow snow and ice to accumulate on the cover. Never trailer at speeds above the speed limit.

**CARE INSTRUCTIONS-** Wash with warm soapy water (while installed if possible) and allow to air dry. For stubborn stains, mild detergent is recommended.

Storing the boat in constant direct sunlight will shorten the life of the cover and the components used to construct it. We recommend storing the boat in a location that exposes it to some sun and also shades it throughout the day. Preferably morning sun and afternoon shade.

**WARRANTY-** This cover includes a two-year warranty from date of purchase against any defects in material or workmanship. If you incur any problems or have any comments please contact your dealer or call Commercial Sewing Customer Service directly at (860) 482-5509.

#### PROPER INSTALLATION-

##### A. Pooling System Installation:

###### Note:

Install anti-pooling system as per illustration putting the front webbing to the cleats, standing pole upright. Pull the other two webbing straps to the two rear cleats. Tighten adjustable buckle strap, until the pole stands upright.

##### B. Proper Cover Installation:

- Place cover on boat starting at front, use cleats as buttons to keep cover in place, work toward back over pooling system until back cleats are "buttoned" in place.
- Maneuver in place until cover fits over gunwale. Check the symmetry. Connect the confidence straps through the openings on the swim platform to the "U" bolts. Disconnect velcro wrap around ratchet. Begin ratcheting by unzipping ratchet pocket(s) and pulling ratchet(s) handle in right-to-left motion until zippered ratchet pocket no longer sags but rests against the hull.
- Pull on webbing to even the tension around the cover and again tighten the ratchet until it does not sag but rests against the boat. Tighten ratchet four to five more times. The ratchet should be very hard to pull with your pinky finger. Zip ratchet pocket closed and connect velcro wrap around ratchet pocket. **On some models:** Connect the rear strap tiedowns in the back of the boat.

**Note:** Proper installation and operation of this cover requires that it be very tight at the gunwale. Retighten as necessary before, after and during stops while trailering. **BE SURE** cover is installed below gunwale before final ratchet adjustment. ZIP ratchet pocket closed for final installation.

**▲ Warning:** Zippered ratchet mechanism should be hand tightened only. Do not pry or attempt to operate ratchet mechanism with any type of tool.

#### REMOVAL-

- Disconnect velcro wrap & zip open ratchet pocket.
- Follow instructions on ratchet label to release pressure.
- Once pressure is released pull out webbing to allow simple future installation, then close handle and ZIP POCKET closed (this is important to prevent damage in future installation).
- Disconnect holddown straps. Remove and fold cover working from rear to front.

#### ANTI-POOLING POLE STORAGE-

- Disconnect anti-pooling pole from either the front (colored webbing) or back.
- After disconnecting collapse poles by pushing buttons and telescoping them down. Wrap webbing around poles.

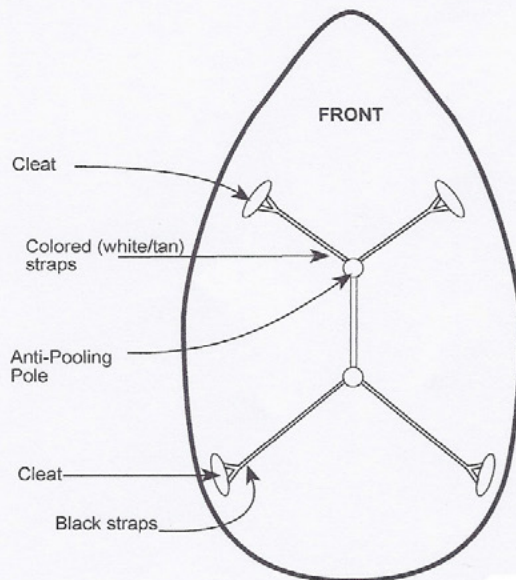

ISBLANKMOORING/R0

## Cockpit Sea-Grass Mating



If installed, cockpit sea grass mats feature urethane backing for marine environments. The mats provide style, comfort and durability as well as additional

protection in environments where microbes are a concern.

Chilewich® products contain Microban®. This antimicrobial protection inhibits the growth of stain and odor-causing bacteria, mold and mildew for the product's life.

When storing your sea grass mats, always roll with the face of product out with the backing facing in. Do not fold or crease as the backing may split. Vacuum or hose off for regular cleaning. Dry face up or hang. Do not machine wash. Matting may be cleaned with a mild detergent and a sponge. Rinse with fresh water. Do not pull on material when removing from cockpit, but rather lift the snap instead to disengage it.



TYPICAL SEA-GRASS MAT IN COCKPIT

 **CAUTION**

AVOID POSSIBLE BODILY INJURY AND PROPERTY DAMAGE!  
DO NOT TOW VESSEL WITH COCKPIT CARPET OR SEA-GRASS MATING IN PLACE. UNSNAP, ROLL, AND STORE IN LOCKER.



## Docking Lights- Typical



If installed docking lights are integrated into the hull near the bow on both port and starboard sides. They are very useful for night mooring approaches and maneuvering. To operate turn on the helm switch marked “docking lights”. It is recommended not to use the docking lights while navigating in open water at night since the illumination could cause a glare on the bow navigation light possibly causing visibility problems for other vessels.

LED type bulbs used in the docking lights are known for long life and low lumen energy usage.

## Electronics



Various electronic components are available on the vessel including single and dual chart plotters.

Each component utilizes individual operator's manuals. Refer to the appropriate electronic component operator's manual for detailed product information since the vast amount of information presented can not be covered here.

These Garmin manuals will cover features, operation, alarm and safety systems along with any cosmetic care and maintenance information.



## Fender Clips

The fender clip option features receivers integrated into the vessel hull side and quick release pins. The quick release pins attach to fenders with lines so they are ready to deploy as needed. When the vessel approaches a mooring the quick release pin with fender is attached to the receiver and pushed into place. This will help protect the boat from dock “rash” which could damage the rub rail or gel coat. When leaving the dock the pins feature a quick release mechanism which detach easily.



FENDER CLIP RECEIVER



FENDER CLIP RELEASE  
PIN

## Ladder-Boarding- Typical

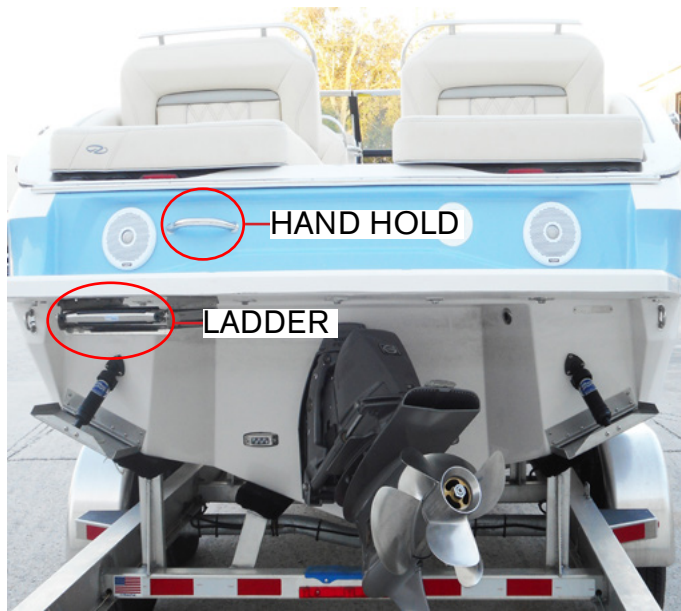

The stern ladder is located under the port side of the swim platform. It is the recommended component for entering or exiting the vessel to and from the water. Be sure to use the hand hold for support as needed when on the ladder.

When not using ladder be sure to keep the ladder locked in the framework as shown in top right photo. Insist that only one person use the ladder at a time. Periodically check the ladder hardware for tightness and corrosion. Replace fasteners and lubricate hinges as needed.

See the cosmetic care chapter regarding cleaning and preserving the stainless steel. Read and understand all warning and information labels found in the vicinity of the ladder.



To use the stern ladder grasp the ladder rung and push the ladder up and in until the ladder round pawl clears the spring loaded scalloped lock of the framework. Pull the ladder out to the end of the travel. Then flip the ladder over and let it down gently. Make sure you keep all body parts clear of any moving ladder parts especially the hinged top.

When reattaching pull the ladder up to retract the rungs. Then grasp the rung and push it into the scalloped lock and pull it down until the round pawl is secured. *Note that some resistance may be felt during both the releasing and attaching process as the ladder framework is spring loaded to complete the locking process.*



## PowerTower- Typical

The S2 PowerTower hinges forward for tight overhead clearances such as bridges, restricted storage situations and towing opportunities. The PowerTower features an aluminum framework with a multi-layered coated finishing process. Read and understand the warning label on the following pages regarding PowerTower usage.

The PowerTower features an all around light, and the ability to anchor major electronic equipment. Select towers feature a bimini top and pylon for water sports. Use the switch marked “tower” found on helm panel to energize the PowerTower. It connects to twin actuators that raise or lower the PowerTower.

Usually located at the aft starboard battery management board (engine compartment) is the PowerTower actuator control box. The purpose of this device is to provide overload protection for the port and starboard actuators that energize the rams to move the PowerTower forward and aft.

Facing the box the left reset breaker protects the port power tower lift actuator. The center reset breaker protects the starboard power tower lift actuator.

The far right breaker protects the entire circuit wiring including the helm. If the PowerTower fails to raise check the box for an “open” breaker. Always find the cause of an open breaker situation before resetting the device.

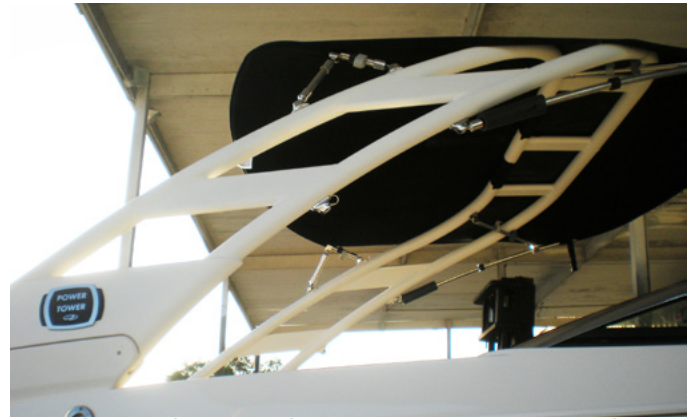

TYPICAL POWERTOWER WITH BIMINI TOP

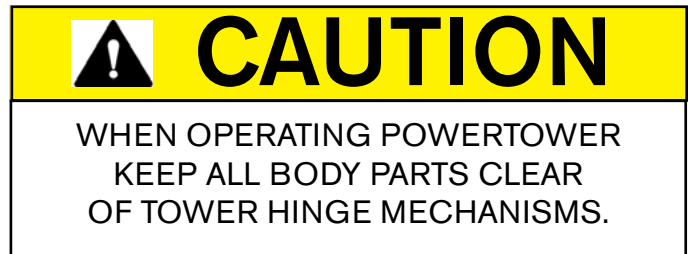

Make sure the operator and all aboard read and understand the above warning.

As the operator energizes the switch to hinge the tower forward visually monitor the port and starboard aft deck to ensure all passengers are clear of the hinge mechanism. This same procedure applies for raising the mechanism to the cruise position.

For highway towing the PowerTower shall be in the complete forward (towing) position and all canvas shall be in their dedicated boots. See photo below. Cockpit mats shall be rolled up and stored in a dedicated cockpit locker.





**AVOID BODILY INJURY OR DEATH DUE TO MISUSE OF THE POWERTOWER!**

**READ AND UNDERSTAND THE FOLLOWING WARNING!**

DO NOT PULL MORE THAN ONE (1) PERSON AT A TIME FROM THE POWERTOWER. USE POWERTOWER ONLY FOR KNEEBOARDING, WATER SKIING, WAKEBOARDING OR WAKE SURFING. THIS POWERTOWER WAS NOT DESIGNED AND SHALL NOT BE USED FOR TUBING, TOWING OF BOATS, PERSONAL WATERCRAFTS, FLOATING DOCKS OR ANY OTHER TYPE OF FLOATING VESSEL OR CRAFT. THIS POWERTOWER SHALL NOT BE USED FOR PULLING PARASAILING OR ANY OTHER EQUIPMENT NOT APPROVED.

THIS POWERTOWER SHALL NOT BE USED TO PULL INFLATABLE WATER SPORTS TOYS OF ANY KIND. NEVER LET PASSENGERS SIT DIRECTLY BEHIND THE POWERTOWER ROPE ATTACHMENT POINT WHILE PULLING APPROVED WATER SPORTS ACTIVITIES. DO NOT LET LOOSE WATER SPORTS ROPE HANG FROM THE POWERTOWER. ALWAYS INSPECT THE POWERTOWER PRIOR TO USE TO ENSURE IT IS NOT DEFORMED, DEFLECTED, AND THAT ALL BOLTS ARE IN PLACE AND TIGHT.

WATER LEVELS CAN VARY DAILY AND IN SOME CASES HOURLY. BE AWARE OF MINIMUM CLEARANCE OF BRIDGES, TREE LIMBS, AND OTHER OBSTACLES, BEFORE ATTEMPTING TO PASS OR GO UNDER ANY OVERHEAD STRUCTURE. WHEN TOWING KEEP POWERTOWER IN THE FURTHEST FORWARD POSITION.

READ AND UNDERSTAND ALL SAFETY LABELS REGARDING THE POWERTOWER IN THIS OWNER'S MANUAL AND INSTALLED ON THE POWERTOWER ITSELF!



## NOTICE

CHECK YOUR STATE LAWS AND REGULATIONS BEFORE ATTEMPTING TO TOW THIS VESSEL. SPECIAL PERMITS AND EQUIPMENT MAY BE NEEDED. FOR HIGHWAY TOWING THE POWERTOWER SHALL BE IN THE COMPLETE FORWARD POSITION. TOW ONLY WITH TRAVEL COVER. BIMINI, BOW, AND COCKPIT COVERS SHALL BE BOOED OR STORED BEFORE TOWING. MATING SHALL BE ROLLED UP AND STORED IN A DEDICATED LOCKER.



Note the bimini top features 100 % solution dyed fabric for longevity. Note that it is not uncommon for this material to wick small amounts of water. To install bimini unzip the boot and pull the top into place. Attach the stainless steel arms into their sockets and secure with pins. Reboot the bimini before highway towing!



As part of select stereo performance package options the remote control may be mounted top side near the transom where it makes controlling the main cockpit unit much easier.

It is a plug and play device and uses the same function buttons and rotary encoder as the helm head unit. It features the ability to select various speaker zones on the vessel. Normally the remote is a working partner with signature speakers, amp and subwoofer.

Refer to the Fusion owner's manual for more detailed information.



## SeaDek

As an option SeaDek® is featured on select vessel swim platform and walk through areas. The non-skid, closed cell material is derived from UV protected non-absorbent foam. You will find the product easy to clean with a high stain resistance.

Other features include noise reduction, great traction even when wet, body comfort when standing, walking or leaning on the swim platform.

To clean small dirt particles first try soap, hot water and a stiff brush.

For surface dirt and footprints use glass cleaner and a clean rag.

If a more thorough cleaning is needed you may use bleach, 409, Simple Green or Soft Scrub. Be sure to rinse thoroughly. Stay away from using any acid base cleaners.

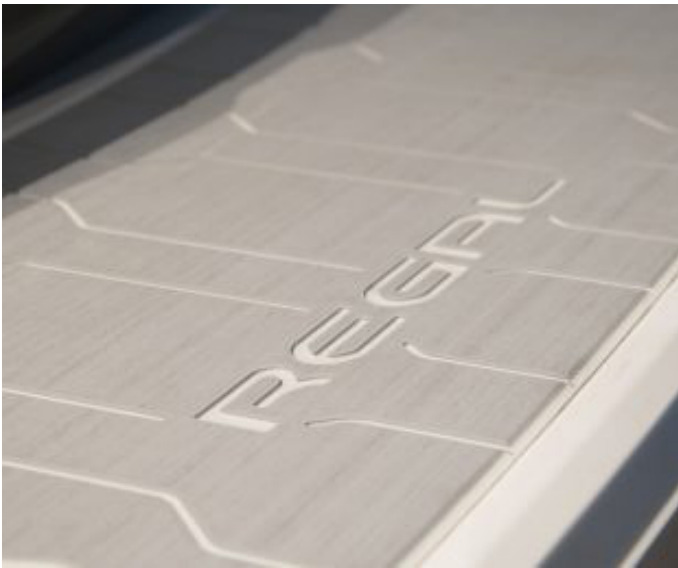

## Seating-Captain



The captain's seat offers multiple features. The seat structure permits the backrest to also serve as a lounge seat with the backrest in the forward position. In addition, select seats use a hydraulic system to slide the seat forward or backward for enhanced visibility and to accommodate body differences. On the helm switch panel press the upper portion of the captain seat switch and hold it. The seat will start to move forward. The bottom portion of the switch will move the seat backward.

***For the safety of the crew and captain never sit on the top of the seat as you could lose control of the throttle and/or the steering wheel.*** Either stand or use the leaning post especially when close maneuvering is required in tight quarters. Select seats offer storage under the chair cushion.

*Note that it is the captain's responsibility when making headway to attach the safety lanyard and shall make sure all passengers are in designated seats and PFD's are worn by everyone aboard.*

### Bow Seat Arm Rests

On selected models bow seating includes arm rests. To use pull the arm rest down until completely extended.



## Table-Teak Typical

If installed the teak bow table is found in a cockpit locker. The table features teak a hardwood known for beauty and durability in the harsh marine environment.

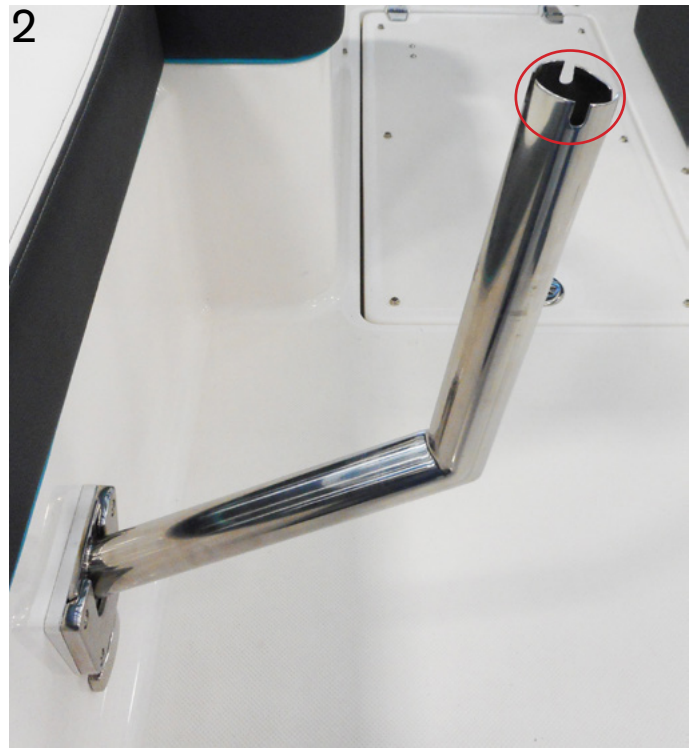

*Note that it is recommended that the table assembly be stored before making a cruise due to possible rough seas or other adverse weather conditions.*

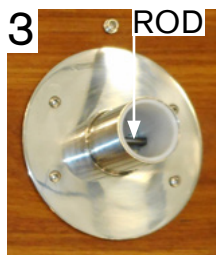

*Note that it is recommended that the table teak surface be maintained by using a teak oil conditioner. See the care chapter of this manual for additional cleaning instructions.*

## Setting Up Table

1. Remove the table from the cockpit storage area. You will need to move the cooler for table access. Unsnap the holding strap and pull out the table.
2. Locate the table leg under the starboard cockpit seat. Unfasten it from the 2 hold down clamps. Insert the leg into a table holder. Note that the table leg features 4 cut outs at the top.
3. The table base features an alignment rod through the top of the base as shown.

4. The table must be inserted down into one of the two sets of holes depending on how the table fits the seating arrangement. The rod when attached to the table will prevent the table from turning while in use. Ensure that the table is down completely into the rod.

5. To disassemble the table reverse the process.



## Trim Switch-Transom



*Note that on outboard models there is usually a tilt switch for trimming the outboard unit while in the water or from the swim platform. The tilt switch is located at the starboard cowling. Read and understand all safety labels and warnings before using the switch. Refer to the outboard owner's manual for more information.*

If installed a trim switch may be located at the transom. This location permits the stern drive to be trimmed from the transom which is great for inspecting the drive and more importantly the propeller without needing to remove the vessel from the water. Since outboards utilize a starboard cowling button for tilting functions it is not available for outboards.

To operate the switch depress and hold the top portion of the switch until the desired “up” trimming angle is realized. Make sure there are no body parts or any other components near the stern drive before you raise it.

To trim the drive unit down depress and hold the lower portion of the switch until the desired “down” trimming angle is realized. Again, make sure there are no body parts or other components near the drive before you lower it.

 **WARNING**

**AVOID SERIOUS INJURY!**  
**KEEP HANDS AND FEET AWAY**  
**FROM DRIVE UNIT**  
**WHEN OPERATING TRIM SWITCH.**



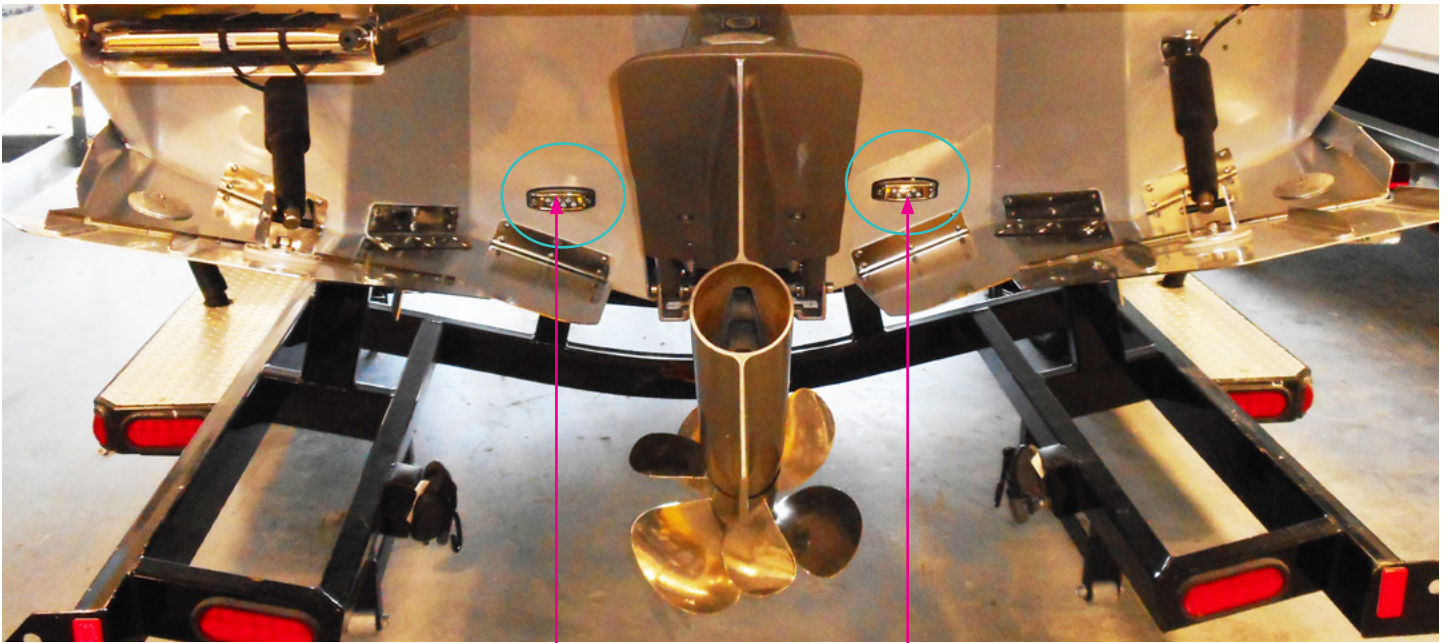

TYPICAL LED UNDERWATER LIGHTS OPTION



### Underwater Lights

As an option light bars w/ blue LED clusters make up the underwater lighting system. The lights are located on the transom along with the port and starboard hull sides. There is a dash switch for energizing the lights and a breaker behind the dash to protect the system.

The underwater light option provides high output, long life and low heat emission. The lights are made from a high impact resistant polycarbonate housing. The lights are installed under the transom for maximum efficiency. A blue beam increases underwater penetration.

These lights are based on LED technology which stands for light emitting diode which can produce various colors depending on the electron chemical makeup inside the semiconductor body of the device.

Over a period of time the environment may cause a film on the light lens. There are protects available at marine and/or auto stores to remove the film.

Another method is to rub the surface of the lens with a fine compound and then buffing the surface with a soft cloth to remove the residue on the lens cover.

## Water Sports Pylon- Pulling Devices



TYPICAL WATER SPORTS OUTBOARD PYLON

As an option a water sports pylon may be installed on your vessel. Read and understand the warning label and installation instructions prior to using the pylon.



*Note the correct line end loop configuration above for water sports activity. Always use a 3rd person spotter to keep a constant lookout for the person engaged in water sports. Do not pull more than 1 person at a time from the pylon. Use pylon only for kneeboarding, water skiing, wakeboarding or wake surfing.*



*Note the correct line end loop configuration above for water sports activity. Always use a 3rd person spotter to keep a constant lookout for the person engaged in water sports. Do not pull more than 1 person at a time from the pylon. Use pylon only for kneeboarding, water skiing, wakeboarding or wake surfing.*

Do not exceed the maximum pull load of 400 pounds as stated in the above warning label.

## Water Sports Tow Ring



WATER SPORTS TOW DEVICE-EXTENDED POSITION



WATER SPORTS TOW DEVICE-STOWED POSITION

A water sports tow device may be installed on your vessel. To use the tow ring push down on the top and it will pop up to an extended user position. Ensure that you look the correct length of line to the device. Use the same configuration for the loop end of the line as shown on the pylon.

Do not pull more than 1 person at a time from the tow ring. Use device only for kneeboarding, water skiing, wakeboarding or wake surfing activities.

Do not exceed a pulling maximum load of 400 pounds on the tow device! Use a 3rd person observer for all water sports activity.



# Chapter 8

## Care & Maintenance

### Cosmetic Care

This section covers the care and maintenance of your Regal boat. Many cosmetic care topics including exterior hardware, upholstery, fiberglass and canvas are covered along with major equipment and systems. Refer to the owner's information packet and the appropriate engine manufacturer's manuals for further detailed instructions.

### Upholstery

Cockpit and interior vinyl require periodic cleaning to maintain a neat appearance and to prevent the build up of dirt, mildew and contaminants that may stain and reduce the vinyl life if they are not removed. The frequency of cleaning depends on the amount of use and conditions to which the vinyl is subjected. Most common stains can be cleaned using warm, soapy water and clear rinses. Scrubbing with a soft bristle brush will help loosen soiled material from embossed surfaces and under welting. If the stains are not removed with the above method use a mild cleaner such as Fantastic. This cleaner should be used only as needed and not the normal means.

With more stubborn stains, rubbing alcohol or mineral spirits may be tried cautiously. Widespread solvent use can severely damage or discolor vinyl. Try to remove stains immediately before they have a chance to penetrate the surface of the vinyl.

Powdered abrasives, steel wool, or industrial strength cleaners are not recommended for cleaning our vinyl. Lacquer solvents will cause immediate damage. Dilute chlorine bleach before using. Do not wax the vinyl as it may cause cracking. Always wear protective gloves and make sure there is sufficient ventilation when cleaning vinyl. Wear eye protection.

Remember that suntan oil will damage vinyl. Use suntan lotion instead of suntan oil. Exposure to the sun is a natural enemy of vinyl upholstery. Keep the vessel covered with a cover when not in use.

### Cockpit Carpet

Use approved cleaners on carpet. Always try on a test area first. Many spots and spills can be removed using a cleaner combined with a clean, white terry towel. Try not to soak an area excessively and do not use solvents because most interior carpet is rubber backed and glued in place. Solvents and abrasives will break down the backing and fibers. Note: Always roll up cockpit carpet before towing your boat. Store carpet in a locker.

### Plastic

Use plastic cleaners and polishes recommended for marine use only. Use proper applicators. Read all instructions carefully. Test the product in a small area first. Use a soft rag and always rinse the surface with water. Ammonia based cleaners and abrasives will damage plastic parts.



## Acrylics

The optional walk-through doors are one item made from a heavy acrylic material. Use warm water and a couple drops of mild detergent, The cleaning rag should be lint free and thoroughly rinsed. Do not substitute paper towels, which could lead to fine scratching of the surface. With the right cleaning materials, you can easily remove most dust and grime without creating an additional static discharge.

Do not use an abrasive or scouring pad. Acrylic must not be exposed to organic, oil-based solvents.

This includes:

- Acetone/nail polish remover
- Paint thinner or comparable
- Benzene
- Rubbing, denatured, or other alcohol-based solutions
- Carbon tetrachloride

For scratches and other marks that do not respond to basic cleaning, polishing is the way to renew your acrylic. Again, use a soft, lint-free cloth. You can hand polish or use a polishing machine.

Apply the polish in a snake like S pattern across the surface first horizontally and then vertically. Smaller polish jobs can use an L shape followed by a circular motion. If you are still not able to remove the blemish the scratch is probably too deep. In these situations, the only recourse is an incremental wet sanding, finishing with an #800 grit abrasive, and another coat of polish. After polishing any residual polish should be removed.

# NOTICE

AVOID CLEANING PLASTIC SURFACES WITH A DRY CLOTH OR GLASS CLEANING SOLUTIONS CONTAINING AMMONIA. NEVER USE SOLVENTS OR WIPE WITH ABRASIVES.

## Spaghetti Mats

Spaghetti mat is used in most of our storage lockers. It is a thick black material that looks like pasta. It provides cushioned support for stored items along with the ability to weep water and condensation through its porous design.

To clean spaghetti mat remove from the storage area and use a hose and nozzle to remove debris. Air dry and reinstall in compartment. Material features ability to dry quickly. For heavier cleaning spray with a mild liquid soap and rinse with fresh water. Air dry.

## Interior Fabrics

Clean flat good interior fabrics with dry cleaning fluid style cleaners approved for use with soft fabrics. Allow adequate ventilation and follow the label instructions carefully. Use a soft cleanser with feldspar to clean stubborn marks or stains on wallpaper. Normal interior vinyl such as used on the headliner on cruisers and head clean up with a mild soap and water solution. Rinse immediately with clean water and wipe dry. Always test an area with a cleaner before applying it to a larger area.

## Fiberglass & Gel Coat

 **DANGER**

AVOID SERIOUS INJURY!  
WAXED GELCOAT SURFACES CAN BE VERY SLIPPERY! DO NOT WAX NORMALLY USED AREAS OF THE DECK, LINER, OR GUNWALES. DO NOT WAX ANY TEXTURED OR NONSKID SURFACES SUCH AS FLOORS, WALKWAYS, STEPS, LADDERS, OR SWIM PLATFORMS. WEAR NON-SLIP FOOTWEAR WHEN WALKING ON VESSEL SURFACES!

**NOTICE**

WIRE BRUSHES, SCOURING PADS, OR OTHER ABRASIVE TYPE MATERIALS AND SOLUTIONS SHOULD NEVER BE USED ON THE HULL OR DECK. THEY CREATE SMALL SCRATCH THAT COLLECT MARINE GROWTH.

Routine maintenance is the only practical way to keep the surface of your boat looking shiny and new. Most objects left outdoors will gradually deteriorate from exposure to the sun, water, dust and pollution. Such outdoor exposure can cause your boat's gel coated surface to change or fade. Darker colors tend to fade more rapidly than lighter colors because they absorb more of the sun's rays (ultra-violet and infrared).

Basic maintenance includes monthly washing of the boat's surface to remove normal accumulation of soil and stain.

Use a mild detergent such as dishwasher powder or liquid. Do not use automatic dishwasher detergent. Avoid any kind of alkaline cleaners such as trisodium phosphate (TSP), abrasives, bleaches and ammonia. For best results use cleaners that are recommended for fiberglass.

It is recommended that you wax the gel coat surface twice yearly to prevent loss of gloss and to protect the finish. Use only waxes for fiberglass and follow the label instructions. Apply a 3' x 3' section at a time using clean applicator cloths or a buffing bonnet. When a haze develops, use a power buffer at low speeds (1200-2000 rpm) to remove the haze. Keep the buffer moving to avoid heat buildup. The power buffer is very efficient at removing contaminants from gel coat. Never wax gel coat in the direct sun.

When the washing and waxing as recommended does not restore the shine it may be necessary to use a fine rubbing compound. Do not apply rubbing compound in direct sunlight. A power buffer at low speed does an excellent job to remove impurities from the gel coat that cause dulling. Use light pressure and keep the buffer moving. Re-wax after compounding to buff the surface.

“Hairline cracks” or “spider webbing” could develop in the gelcoat surface of a hull or deck. This can be caused by impact or other factors. Small air pockets or gouges may also occur through normal wear.

These do not affect the strength of the hull or deck and can be repaired by yourself, a marine professional or a Regal dealer.

The affected area should be chipped or sanded away and a thin layer of color matched gel coat applied. This layer is then sanded smooth and buffed to its original luster.

Most minor scratches, nicks, and dents can be removed by compounding the surface. Marine type compounds can be found at most auto body supply stores. Specify a number 25 which is a coarser compound up to a number 55 being less coarse. Various glazes and polishes are available as needed. Ask your marine professional or Regal dealer for more information. Fiberglass hulls are strong but they can be damaged. A fiberglass hull has virtually no internal stresses. Thus when a part is broken or punctured, the rest of the hull retains its original shape. A severe blow will either be absorbed or result in a definite localized break. A break of this nature should be checked and repaired by a marine professional or a Regal dealer.

## Minor Repairs

You will need the following materials for minor repairs:

- Gel coat
- Clear Liquid Catalyst
- Putty Knife
- Razor Blade
- Fine Sandpaper (400,600,1000)
- Wax Paper (to cover repair area)

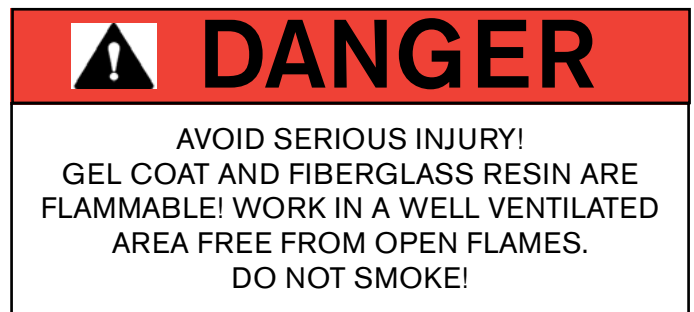

For minor repairs refer to the following procedure:

1. Clean the area to be repaired and get rid of any wax or grease residues.
2. Clean out scratches, chips, and nicks.
3. Sand area to be repaired so gel coat will bond.
4. In a separate container, measure only the amount of gel coat you will need. Mix a ratio of 2% ratio of catalyst to the amount of gel coat being used (a spoonful of gel coat will require only a drop or two of catalyst). Do not pour any unused portions of the gel coat/catalyst mixture back into either original container.

5. Apply gel coat to area leaving a slight lift above the surface.

6. Cover the area with wax paper. It will help the mixture to set up faster.

7. Remove wax paper and shave off any extra gel coat with a razor blade.

8. After the area is shaved smooth, start with the 400, 600, and finally 1000 grit sand papers.

9. Buff the area with compound, polish and a finish wax. You may notice a difference between the repaired area and the original finish due to the natural weathering process.

## **Canvas**

Boat canvas is in most cases subjected to more severe punishment than practically any other type of material. Moisture, dirt and chemicals from industrial fallout, heat, ultraviolet rays and salt water are all factors which accelerate the deterioration of your boat canvas. These elements can cause serious damage if left unchecked.

The boat top and other canvas supplied on your Regal boat are manufactured from top quality materials to provide you with years of trouble free service. The following information on the care, cleaning and proper storage of the fabrics and fasteners that make up your marine canvas is being provided to help you maintain the appearance and ease of operation.

## **Sunbrella General Information**

Sunbrella is used on select bow, cockpit covers and bimini tops. Sunbrella is a woven fabric made from 100% solution dyed acrylic fiber. It is color fast and will withstand long term exposure to the sun (ultraviolet rays) without excessive fading.

Even though it is treated with water repellency some "misting" through the fabric is typical. With new canvas, the greatest potential for leakage is through any sewn seams. Because Sunbrella and the long term thread used is synthetic, the holes created by sewing will not swell up and seal when exposed to water as cotton does. Usually the movement of the fabric in use will move the fibers enough to seal the holes. You may apply Apseal or Uniseal to the seams to speed up this process.

When the canvas is new, the fit will normally be tight. It is designed this way because Sunbrella stretches as it ages. The initial tight fit allows for a suitable fit for the life of the canvas. The Sunbrella fit will vary slightly in the heat, cold, and rain.

Sunbrella canvas should be cleaned regularly before substances such as dirt, roof particles, etc., are allowed to accumulate on and become embedded in the fabric. The fabric can be cleaned without being removed from the boat. Simply brush off any loose dirt, hose down, and clean with a mild solution of natural soap in lukewarm water. Rinse thoroughly to remove soap. **DO NOT USE DETERGENTS!** Allow to air dry.

For heavily soiled fabric, remove the top from the frame.

Soak the fabric in a solution that has been mixed to the following proportions.: 1/2 cup of bleach and 1/4 cup of Ivory or Lux soap (liquid or soap) per each gallon of lukewarm water. Allow the fabric to soak until the bleach has killed the mildew and the stains can be brushed out with a common kitchen scrub brush. Rinse the fabric thoroughly in cold water to remove all the soap. This may require several rinsings. Incomplete rinsing can cause deterioration of sewing threads and prohibit the fabric from being properly retreated. Allow the fabric to dry completely. **DO NOT STEAM PRESS OR DRY IN AN ELECTRIC OR GAS DRYER!** Excessive heat can damage and shrink the fabric since it is heat sensitive.

This method of cleaning may remove part of the water and stain repellent that was applied to the fabric during its manufacture. It is recommended to retreat with such water repellency products as Apseal and Uniseal. We do not recommend any wax based treatments such as Thompson's Water Seal or any of the silicone products such as SC-15 or Aqua-Tite. Wax based products prevent the fabric from breathing, and encourage mildew growth while the silicone products interact with the original fluorocarbon finish and seem to cause a rapid loss of water repellency.

### Clear Vinyl, Zipper & Snap Care

Never store canvas wet or in an unventilated, moist area. Always roll the canvas instead of folding. This is of particular importance on side curtains or any other part with the clear vinyl "glass". Roll the top carefully around the bows and cover with the storage boot provided.

The clear vinyl "glass" used in side curtains, aft curtains, visors, and camper enclosures is very susceptible to heat and cold. Keep vinyl curtains from touching metal tubing to minimize burning the vinyl. If the boat is stored with top, side curtains and aft curtain in place, heat build up inside the boat may discolor the vinyl. To clean the clear "vinyl" glass, use a solution of Ivory or Lux soap, liquid or flakes, and lukewarm water. Allow to air dry. Never use any type of abrasive cleaner as it will scratch the "vinyl" glass. There are many cleaners and scratch removers on the market specifically for clear vinyl. Handle the clear curtains carefully. They are soft and prone to scratching.

Canvas parts are designed with zippers. When zippers are new they can be a little difficult to use. Zip carefully without forcing the zipper or the material. They will loosen with use. A zipper lubricant may be used to help new zippers as well as maintaining used ones. The most vulnerable part of the zipper is the starts. Use care when beginning to close the zipper.

Canvas snap fasteners should be unsnapped as close to the button as possible. Never remove canvas by pulling roughly on the edge of the material. This can damage the canvas as well as the fasteners. Use petroleum jelly on snaps to keep them from developing corrosion especially in harsh environments.

### Metal

Keep all stainless steel and other metal parts rinsed and wiped dry. To maintain their finish annually polish the stainless steel and other bright works at least annually. Use commercially available metal products and read the labels carefully before use.



Refer to the flyer in the owners information pouch.  
 Most marinas and boating retail outlets carry metal care products.

## Hull Bottom

Never use wire brushes or highly abrasive scouring pads on your hull bottom. It could damage the gel coat surface or the bottom paint. The bottom of your boat needs to be clean since the build up of natural coatings from water or marine life can potentially create drag and affect your boat's performance.

FREQUENT STAINS/CLEAN-UP STEPS	1	2	3
Coffee, Tea, Chocolate.....	B		
Permanent Marker*.....	E	B	C
Household Dirt.....	A	B	
Grease.....	D	B	
Ketchup, Tomato Products.....	A	B	
Latex Paint.....	A	B	
Oil Base Paint.....	D	B	
Mustard.....	A	B	C
Suntan Oil.....	A	B	
Asphalt/Road Tar.....	D	B	
Crayon.....	D	B	
Engine Oil.....	B		
Spray Paint.....	B		
Chewing Gum.....	D	A	
Shoe Polish*.....	D	B	
Ballpoint Pen*.....	E	B	A
Lipstick.....	A	B	
Eyeshadow.....	E	B	
Mildew*.....	C	B	A
Wet Leaves *.....	C	B	A

A= Soft brush; warm soapy water/rinse/ dry

B= Fantastik cleaner

C= One tablespoon ammonia, 1/4 cup of hydrogen peroxide, 3/4 cup of warm water/ rinse/dry

D= Scrape off residue ( use ice to lift gum)

E= Denatured alcohol/rinse/dry

\* These products contain dyes which leave permanent stains.

## Maintenance

### Propellers



Out-of-balance and nicked propellers will effect performance or cause vibration. Damaged props should be replaced, but those

that are chipped or bent can usually be reconditioned by a marine dealer or a propeller repair facility. When cruising, consider carrying a spare set of props on board because many marinas do not carry a full inventory of replacement propellers. Also, include an extra set of prop hardware. Refer to the engine manufacturer's manual for appropriate propeller replacement and installation assistance.

Write down the propeller diameter and pitch while the vessel is in dry dock. They are pressed into the prop for easy reading.

Also, note that propellers feature a rubber hub pressed into the center propeller that includes the hole for the prop shaft to slide through. Sometimes as a result of impact the rubber hub becomes damaged and the propeller will not let the boat perform up to the rated revolutions per minute (rpm).

In an emergency a stainless propeller blade may be straightened by laying the propeller blade on a 2 x 4 and hammering the bent portion of the blade until straight. This normally will result in the propeller creating a vibration and if this occurs reduce rpm until back at mooring.

It is advantageous to carry the needed tools to change propellers including pliers to pull cotter key and deep socket and ratchet to remove the propeller shaft nut. See the appropriate outboard manufacturer's owner's manual for further information.

Removing the propeller- Before removing the propeller make sure the remote control is in neutral and the ignition keys are removed to prevent the engine starting and possibly causing bodily injury. Always wear gloves when removing or installing propellers since the component blades are very sharp.

Note that special tools are required to remove the DPS style propellers. Contact your nearest Regal dealer for assistance in purchasing and procuring these tools.

Installing propeller- Before installing parts back on to the prop shaft make sure you lubricate the prop shaft with the recommended lube. Again, special tools are required for installation of propellers and hardware. Contact your closest Regal dealer for additional information.

On MerCruiser units, refer to your engine operation manual or contact your closest Regal dealer for propeller removal and installation parts, tools, and periodic maintenance schedules and information.

## Battery



Frequently check your battery terminals for corrosion build-up. If you find a greenish, powdery substance, remove the cable connections and clean

both the both the terminals and the connectors with a wire brush. When the cleaning is finished reconnect the battery cables and coat the terminal with an approved grease or petroleum jelly to help prevent further corrosion.

Check the electrolyte level at least every 30 days, more often in hot weather. The level should be maintained between the top of the battery plates and the bottom of the fill cap opening.

Add distilled water as needed after charging the batteries or periodically as needed. Do not overfill because sulfuric acid could run over and cause burns or an explosion.

Batteries should be charged outside the boat. Do not smoke or bring flames near a battery that is being or has recently been charged. The hydrogen gas generated by battery charging is highly explosive. Set batteries on a block of wood rather than concrete since this procedure will help the batteries from losing their charge.

Do not allow a metal object or loose wires to spark across battery posts while working close to the battery. Contact across terminals will cause a short circuit and personal injury may result.

Tighten all battery connectors securely. Check their tightness by pulling on the connectors. They should not move from their tightened position. Be sure to reinstall the positive boot over the battery terminal after tightening the battery post connection. While using the boat, use the volt meter to monitor the charge level of the battery. Monitor the charge with the engines turned off (static condition).

The engine alternators recharge the batteries. A fully charged battery will indicate between 12.3 and 12.6 volts on the voltmeter. Readings below this could indicate a dead battery cell or a charging system malfunction which should be checked by a marine professional.



## WARNING

**AVOID SERIOUS INJURY!**  
BATTERIES CONTAIN SULFURIC ACID (POISON) WHICH ALSO CAN CAUSE BURNS. AVOID CONTACT WITH THE SKIN, EYES, AND CLOTHING. IF CONTACTED, FLUSH WITH WATER FOR AT LEAST 15 MINUTES. IF SWALLOWED, DRINK LARGE AMOUNTS OF WATER, OR MILK. FOLLOW UP WITH MILK OF MAGNESIA, BEATEN EGG, OR VEGETABLE OIL. GET MEDICAL ATTENTION IMMEDIATELY!



## WARNING

**AVOID SERIOUS INJURY!**  
WEAR GOGGLES, RUBBER GLOVES, AND A PROTECTIVE APRON WHEN WORKING WITH A BATTERY. BATTERY ELECTROLYTE CAUSES SEVERE EYE DAMAGE AND SKIN BURNS. IN CASE OF SPILLAGE, WASH AREA WITH A SOLUTION OF BAKING SODA AND WATER.

Make sure all terminals are clean. As discussed earlier, a battery cleaner tool along with a toothbrush should be used to clean both the positive and negative terminals. Use a small amount of baking soda and water. Remove any acid residue from the terminal area and battery top with a damp cloth. Be sure to wear plastic gloves and eye protection. See the illustration.

Install an anti-corrosion lubricant to the posts before reinstalling the terminals. This lubricant is available as a paste or spray type and can be found at most marina or auto supply stores.

Be sure to reinstall any red (+) battery (anti-short) boots on the battery terminals.



## Remote Control-Typical



Check the helm control box and make sure there is no roughness or tightness when shifting. Also, check to make sure the control box hardware is tightly secured. The shifting is done by

a process called “fly by wire” Being the engines use electronics to shift it should be effortless. An application of silicone spray on the handles will help fight any corrosion. Remember there are no actual mechanical shift and throttle control cables on your vessel.

There is a friction control which may be altered to personal needs. To adjust the friction control on side mount remote controls it needs to be preformed by an authorized dealer. Contact your closest Regal dealer for further assistance or a marine professional.



## Fuel System

At least annually inspect all fuel system components for loose clamps at the vent, fill and feed locations. Examine each hose for signs of deterioration and leakage. Check the fuel sender for loose bolts, nuts, and leaks at all areas of contact. Also, inspect the fuel tank for signs of leakage or abrasion. Tighten all components as needed.

 **WARNING**

AVOID SERIOUS INJURY OR DEATH DUE TO  
FIRE OR EXPLOSION RESULTING FROM  
LEAKING FUEL!  
INSPECT ENTIRE FUEL SYSTEM  
AT LEAST ONCE PER YEAR.

## Stereo

The Fusion® stereo head unit requires little maintenance. When washing the cockpit, do not discharge water directly at the stereo unit. Possible damage may result. As with any CD unit clean your CD's to keep them from skipping. This process also aids in keeping dust out of the unit. For further information, refer to your stereo owner's manual located in the owner's packet.

TYPICAL EPA FUEL TANK

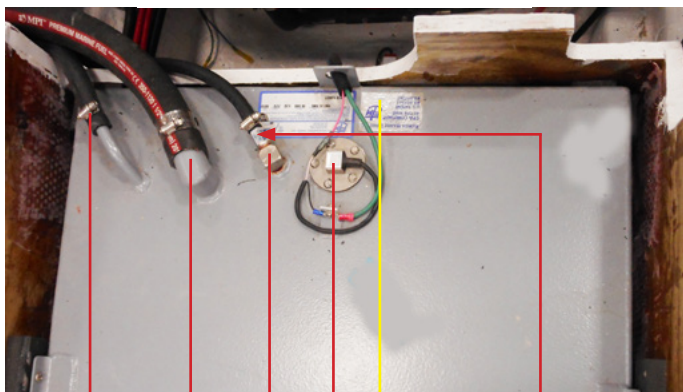

TANK LABEL

FUEL FILL

FUEL SENDER

FUEL VENT FUEL FEED ANTI-SIPHON VALVE

## Galvanic Corrosion/Stray Current

Metal parts underwater can be subjected to two basic styles of electrolysis: galvanic corrosion and stray current corrosion. Both can damage the outboard drive, propeller, underwater parts, boat and motor if not correctly monitored (testing at 2 week intervals) and avoided.

Galvanic corrosion is an electrochemical reaction between two or more metals. Drive systems consist of several different metals. Some are more active than others.

Galvanic corrosion of the more chemically active metals can occur whenever two or more dissimilar metals that are “grounded” (connected by actually touching each other, or through a wire or metal part) are immersed in a conductive solution (any material that can conduct electricity). Anything but pure water is conductive. Saltwater, fresh water with a high mineral content and polluted freshwater are highly conductive. Conductivity increases with temperature. That is why Florida boats experience more corrosion than boats in Maine.

Specifically look at a typical marine drive unit with a stainless steel propeller. The aluminum is the more chemically active metal (called the anode) and the stainless steel propeller is the less chemically active metal (called the cathode).

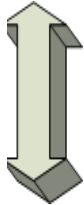
CORROSION TABLE	
Gold	 <p>Least Active</p> <p>Most Active</p>
Stainless Steel	
Bronze	
Copper	
Brass	
Steel	
Aluminum	
Zinc	
Magnesium	

Typically electrons flow from the anode (the aluminum drive unit), via the external conducting path to the cathode (stainless steel propeller). If there is a very large anode connected to a small cathode, the anode will corrode very slowly. If a very large cathode is connected to a small anode, the anode will corrode very quickly. Obviously, if you do not control galvanic corrosion, over time the aluminum will corrode away.

The first sign of galvanic corrosion is paint blistering (starting on sharp edges) below the water line- a white powdery substance forms on the exposed metal areas. As the corrosion advances, the exposed metal will become deeply pitted as the metal is actually eaten away.

Another condition which will increase galvanic corrosion is the removal or reduction in surface area of the sacrificial anodes. Never add aftermarket products that are connected to the engine ground such as stainless steel steering aids and trim planes. Zinc connected to aluminum will form a corrosion cell but the aluminum (drive) becomes the cathode and the zinc (anode) corrodes.

Even though your boat may not have shore power aboard current from nearby vessels with shore power can produce stray current galvanic corrosion. Stray current corrosion occurs when metal with an electrical current flowing into it is immersed in water that is grounded (lake, ocean, pond). The current can leave the metal and flow through the water to ground. This will cause rapid corrosion of the metal at the point where the current leaves.

When a vessel nearby is plugged into shore power, they can potentially tie your drive unit to their boat via the green grounding shore power lead. Your drive unit could be the receiving end of a large galvanic cell (a battery) interconnected with nearby vessels or even through the marina's metal structures via their electrical system.

The vessel should be tested every couple of weeks to determine the integrity of the anode protection system. Another way to test the system is to measure the hull potential. This is accomplished by immersing a reference electrode, usually a silver/silver chloride into the water about six inches behind the drive. With leads attached to a digital multimeter the hull potential is read on the DC scale and compared to recommended specifications for the water body type. See the owner's information vendor packet for more information or contact your nearest authorized Regal dealer.

#### Tips To Aid In Maintaining Galvanic Integrity

1. Test the galvanic integrity of your vessel every 2 weeks. Raise the drive and inspect anodes/parts for signs of galvanic corrosion, stray current corrosion or loose fasteners. Contact your closest Regal dealer/marine professional where signs of galvanic corrosion exist.
2. Never paint over anodes as they will become inoperative. Always leave at least one inch between bottom paint and any underwater fitting such as sea cocks, swim platform stanchions and all drive and propulsion related underwater parts.

3. Periodically remove vessel from water and clean/pressure wash all drive, anode and hull bottom areas to remove growth.

4. Ensure vessel is using the correct anode metal for the body of water that it is moored. See the engine manufacturer's manual for more information or contact an authorized dealer.

5. Ensure that the drive is completely "in" down to provide more complete anode protection when vessel is moored.

6. Do not attempt to use magnesium anodes in saltwater. They will provide over protection.

7. If marina moored, contact appropriate personnel if signs of galvanic corrosion appear on your drive system. Ask them to check for stray electrical current which may be originating from a nearby vessel's faulty DC wiring or from a marina pier, piling or dock carrying leaking marina ground wiring such as a dock side cord partially submerged.

<b>GALVANIC/STRAY CURRENT CORROSION</b>	
<b>Cause/Observed Condition</b>	<b>Corrective Action</b>
Sacrificial anodes consumed	Replace anodes when 30% consumed
Sacrificial anodes not grounded to drive	Remove anodes, clean contact surface, reinstall, check for continuity
Loss of continuity between underwater parts & ground	Provide good ground connections
Nearby vessel with stray current	Contact appropriate personnel Remove your vessel from water
Paint on drive heavily worn, exposing more metal	Prime and repaint or install additional anodes
Sacrificial anodes painted	Remove paint or replace anodes
Drive tilted/anodes out of water	Leave drive down, install additional anodes below water
Power trim cylinders only corroded	Provide a good ground to drive, all parts must be grounded
Corrosion in area of exhaust outlets	Remove deposits
Corrosion occurring after vessel is removed from saltwater	Wash exterior and flush interior with freshwater
Stainless steel parts corroding	Clean parts, remove foreign material, ensure continuity
Underwater drive parts corroded, sacrificial anodes OK	Oxide film on anode (fresh water only) Replace anode Poor ground. Scrape anode

## Zinc Anodes



Sacrificial zinc anodes are located on the drive housing, trim tabs and/or prop shaft to protect softer metals exposed to the water. Electrolysis attacks the least noble metals first. Because

zinc is a less noble metal, it will decompose before other metals. Check these zinc anodes periodically and have them replaced when they are 30% consumed. Notwithstanding, zinc is the most popular metal used to protect parts that are exposed to saltwater, freshwater or brackish water.

See the photos below for anode location on your stern drive.

Zinc anodes in brackish or salt water need to be checked more frequently. If the anodes seem to be requiring frequent replacement there may be a boat leaking DC current into the water taxing the anodes. This is especially possible around a marina environment. Contact a marine professional who can measure the galvanic activity with a special electrode and electric VOA meter. Refer to the engine manufacturer's manual for exact anode location and detailed information.

Inspect the ground leads for tightness if attached.

*Note that parts damage due to galvanic or stray current corrosion is not covered under warranty.*



# Chapter 9

## Troubleshooting

The following diagnostic information will assist you in identifying minor electrical, fuel, and mechanical problems. Some of the items listed require technical training and tools. Additional assistance is available in the engine manufacturer's owner's manual. Also, you can contact your closest Regal dealer or marine professional for more information. Sometimes a problem can be solved by performing a logical sequence of elimination and/or root cause techniques.

*Note that the diagnostic information on the following pages covers stern drives and outboards. For further detailed model specific information refer to your propulsion owner's manual.*



### **WARNING**

AVOID SERIOUS INJURY OR DEATH!  
BEFORE PERFORMING ANY MAINTENANCE  
WORK, TURN OFF THE BATTERY SWITCH  
AND REMOVE THE IGNITION KEY  
FROM THE SWITCH.



### **WARNING**

AVOID SERIOUS INJURY OR DEATH!  
USE ONLY APPROVED MARINE  
REPLACEMENT PARTS THAT  
ARE IGNITION PROTECTED.

# ENGINE DIAGNOSTIC CHART

<b>Problem</b>	<b>Possible Cause</b>
Engine Overheating	<p>Water pick-up feeds are blocked by debris, especially plastic bag material.</p> <p>Cooling system leak</p> <p>Impeller is worn or blocked by debris</p> <p>Propeller is over propped for the circumstances, causing the engine to work extra hard</p> <p>Debris in oil is holding heat more than normal - bad oil filter</p> <p>Defective thermostat.</p>
Starter Will Not Crank	<p>Battery weak or dead</p> <p>Starter defective</p> <p>Fuse for electric start relay blown</p> <p>Control not in neutral</p> <p>Defective start panel button</p>
Excessive Steering Play	<p>Air in steering lines (Bleed)</p> <p>System low on steering fluid</p> <p>Mechanical parts-loose connection</p>

# ENGINE DIAGNOSTIC CHART

Problem	Possible Cause
No Power To Helm	Battery switch turned off  Batteries are weak or dead.  Main breaker tripped  Loose connection
Engine Cranks But Will Not Start	Fuel flow obstructed/water in fuel  Low battery voltage  Engine ignition system malfunction  Timing belt broken  No fuel in tank  Lanyard not attached  Control not in neutral
Hard Starting	Vacuum In Fuel System  Fuel lines obstructed  Water in fuel  Debris in fuel/clogged fuel filter
Engine Idles/ Runs Rough	Old fuel  Faulty spark plugs  Fuel contaminated/ clogged anti-siphon

# ENGINE DIAGNOSTIC CHART

<b>Problem</b>	<b>Possible Cause</b>
Power Loss	Damaged propeller Improper trim angle Spark plugs fouled Fuel system malfunction Hull bottom fouled with debris Excess water in bilge (leak)
Excessive Vibration	Damaged propeller Damaged propeller shaft Loose/broken motor mount Steering pivot loose or damaged Debris caught on propeller Ignition malfunction Motor mount bolts loose (transom)

# ENGINE DIAGNOSTIC CHART

<b>Problem</b>	<b>Possible Cause</b>
Buzzer Sounds/Icon Lights	Cooling system malfunction  Engine oil level low or incorrect type  Wrong spark plug heat range  Oil pump malfunction



# DC ELECTRICAL SYSTEM DIAGNOSTIC CHART

<b>Problem</b>	<b>Possible Cause</b>
No 12 Volt Power At Battery	Battery switch turned off  Weak or dead battery  Battery cables loose/disconnected
Battery Not Charging While Engine Is Running	Faulty alternator  Faulty circuit wiring
Battery Will Not Hold Charge	Faulty/ old battery  Loose battery cables  Corroded battery terminals
12 Volt Equipment Not Working	Fuse blown-Take time to investigate why the equipment was drawing too much current or why it had a short circuit. Check fuses at fuse block and under the engine shroud Weak or dead battery if all 12 volt equipment fails to function.  Corroded / loose wire connection  Internal equipment short /failure  Breaker tripped  Battery switch turned off

# STEREO DIAGNOSTIC CHART

**Problem**

**Possible Cause**

Advisory	Description	Resolutions
Check Antenna	The radio has detected a fault with the SiriusXM antenna. The antenna cable may be disconnected or damaged.	<ul style="list-style-type: none"> <li>Verify the antenna cable is connected to the SiriusXM Connect Vehicle Tuner.</li> <li>Inspect the antenna cable for damage and kinks. Replace the antenna if the cable is damaged. SiriusXM products are available at your local car audio retailer, or at <a href="http://www.shop.siriusxm.com">www.shop.siriusxm.com</a>.</li> </ul>
Check Tuner	The stereo is having difficulty communicating with the SiriusXM Connect Vehicle Tuner. The tuner may be disconnected or damaged.	Verify the SiriusXM Connect Vehicle Tuner cable is connected securely to the stereo.
No Signal	The SiriusXM Connect Vehicle Tuner is having difficulty receiving the SiriusXM satellite signal.	<ul style="list-style-type: none"> <li>Verify the SiriusXM antenna is outdoors with a clear view of the sky.</li> <li>Verify the SiriusXM antenna is mounted securely.</li> <li>Remove obstructions above or next to the SiriusXM antenna.</li> <li>Inspect the cable antenna for damage and kinks. Replace the antenna if the cable is damaged. SiriusXM products are available at your local car audio retailer or at <a href="http://www.shop.siriusxm.com">www.shop.siriusxm.com</a>.</li> <li>Consult the SiriusXM Connect Vehicle Tuner installation instructions for more information on antenna installation.</li> </ul>
Subscription Updated	The radio has detected a change in your SiriusXM subscription status.	<ul style="list-style-type: none"> <li>Select any button to clear the message.</li> <li>Go to <a href="http://www.siriusxm.com">www.siriusxm.com</a> or call 866-635-2349 with questions about your subscription.</li> </ul>
Channel Not Available	The channel you requested is not a valid SiriusXM channel, or the channel that you were listening to is no longer available. You may see this message briefly the first time you connect a new SiriusXM Connect Vehicle Tuner.	Go to <a href="http://www.siriusxm.com">www.siriusxm.com</a> for more information about the SiriusXM channel lineup.
Channel Not Subscribed	The channel you requested is not included in your SiriusXM subscription package, or the channel you were listening to is no longer included in your SiriusXM subscription package.	Go to <a href="http://www.siriusxm.com">www.siriusxm.com</a> or call 866-635-2349 for more information about your subscription package or to subscribe to the channel.
Channel Locked	The channel you requested is locked by the parental control feature.	Refer to the parental control section in the owner's manual to unlock channels.

# SURF ELECTRICAL SYSTEM DIAGNOSTIC CHART

<b>Problem</b>	<b>Possible Cause</b>
No Voltage At Surf Display Unit	<p>Battery switch turned off</p> <p>Weak or dead battery</p> <p>Battery cables loose</p> <p>NMEA 2000 backbone unit connection/communication</p> <p>Garmin Surf Display not activated</p> <p>Garmin Surf Display 7.5 amp fuse blown at helm fuse panel. Take time to investigate why the equipment was drawing too much current or why it had a short circuit.</p>
Surf Ballast Bag Pump Not Working	<p>Corroded/loose wire connection in surf pump circuit</p> <p>Internal pump- impeller failure</p> <p>NMEA 2000 backbone unit connection/communication</p>

# Chapter 10

## Storage & Winterization

### Overview



Storage procedures are outlined in this chapter. These are general guidelines to follow before longer periods such as over the winter in colder climates. Note that guidelines or systems mentioned may not be found on your model. Be sure to familiarize yourself with all relevant information in the owner's sacht.

Special winterization procedures are necessary for the boat equipment and systems. Use the enclosed checklists to help you identify areas of concern and maintenance. Call a Regal dealer or marine professional for further information regarding storage/maintenance procedures. Also, more specific information can be found in the engine manufacturers owners manual.

*Note when using hoist equipment for lifting attach lifting hardware to the bow and stern eyes being careful to avoid swim platform integrity,*



## WARNING

AVOID SERIOUS INJURY OR DEATH  
DUE TO FIRE AND EXPLOSION!  
DO NOT FILL FUEL TANK TO RATED  
CAPACITY. LEAVE ROOM FOR EXPANSION.

## NOTICE

REMOVE BATTERIES WHEN VESSEL  
IS IN LONG PERIODS OF STORAGE  
ESPECIALLY IN COLD CLIMATES.  
BATTERIES CAN FREEZE AND POSSIBLY  
LOSE ELECTROLYTE.

## NOTICE

AVOID SERIOUS ENGINE DAMAGE!  
USE ONLY FACTORY APPROVED PRODUCTS  
FOR ENGINE AND DRIVE DURING STORAGE  
PERIODS.

## NOTICE

AVOID VESSEL AND/OR ENGINE DAMAGE!  
CONTACT A MARINE PROFESSIONAL  
FOR WINTERIZATION ASSISTANCE.  
DAMAGE CAUSED BY  
IMPROPER WINTERIZATION IS NOT  
COVERED BY VESSEL  
OR ENGINE MANUFACTURER.

## Decommissioning Checklist

### Engine Winterization/Maintenance

- Run engine. Pour approved fuel stabilizer/conditioner in the fuel tank. Allow time for it to circulate through the fuel system.
- Change all engine fluids as referenced in the engine manufacturer's owners manual. Contact a Regal dealer.
- Check engine hoses, clamps, and system wiring for loose connections, abrasion, and corrosion.
- Spray all exterior parts with a rust preventative.
- On surf models drain all ballast bags, hoses, and pumps of water. Check all related components.
- Perform maintenance as referenced in the manufacturer's owners manual. Contact your Regal dealer.
- Remove propellers. Refurbish as needed.

### Engine Care

- After cleaning use touch up paint on unit as needed.
- Apply coat of wax to stern drive exterior parts.

### Boat

- Check hull bottom for any fiberglass damage.
- After cleaning apply wax to hull and deck surfaces.

- Pour a pint of 50/50 antifreeze into bilge pump.
- Remove batteries. Use a trickle charger as needed.
- Remove all loose gear and electronics from boat. Inspect all equipment for wear and damage. Store in a clean, dry environment.



- Remove aft hull drain plug. Clean drain plug hole of debris as needed. If loose enclose drain plug in plastic bag and tie to steering wheel.
- Make sure bow is higher than stern to permit proper drainage.
- Clean all upholstery and store so it breathes.
- Conduct a visual inspection to ensure boat is balanced properly on the trailer, cradle or blocks.
- Cover boat with appropriate cover. Tie down for protection from rain, snow and/or wind. Prop up cover to provide proper ventilation. Do not cover up the fuel vents.
- Drain the fresh water system per instructions in this chapter.
- When possible use sling locations for lifting boat.
- **Never block up boat bottom! May cause structural damage which is not covered under warranty.**



## Trailer

- Repack all wheel bearings per manufacturer's specifications.
- Check all trailer parts for excessive wear. Replace/ refurbish as needed.
- Use touch up paint on trailer as needed.
- Lubricate all moving parts as needed.
- Check all lighting and brakes (if applicable).

## Typical Pressurized Water System-If Installed

1. Activate the pressure water pump switch.
2. Open all faucets including transom shower (if equipped) and allow tank to empty.
3. Drain the water tank. Shut off water pump switch.
4. Mix nontoxic antifreeze with water in accordance with the manufacturer's recommendations. (Available at marina & RV stores)
5. Pour solution into the water tank.
6. Turn on pressure water pump switch.
7. Open water faucet and purge until a steady stream of nontoxic antifreeze flows from the faucet. If equipped, do the same to the transom shower. Turn the pressure water switch to the "off" position.

## Waste System-If Installed

1. With chemical heads, make sure to dump both upper and lower tanks. Rinse well with fresh water. Sanitize chemical head as needed.

## Recommissioning Checklist

### Engine

- Check all components per engine manufacturer's owner's manual especially fluid levels.
- Run engine on "ear muffs" (flushette) before launching. Check for fuel, exhaust, oil, and water leaks.

### Boat

- Install drain plug.
- Install battery and tighten all terminals.
- Check all equipment, switches, alarms, gauges and breakers for proper operation.
- Add necessary chemicals and water to chemical head.
- Add water to water tank. Turn on faucet to purge tank. Refill water tank.
- Make sure all safety gear is on board and in excellent working condition.
- After launching, check controls and systems for proper operation through chart plotter screen/information panel.

### Trailer

- Make sure all equipment is in excellent working condition including all winch, tongue jack, brake actuator and lines. Check lighting with battery.

# Chapter 11

## Towing

### Overview

This chapter covers towing basics including equipment, maintenance, and techniques of using a trailer. Check with state and local agencies for detailed information on required equipment, safety issues, and licensing.

### BEFORE TOWING

Before towing your boat, be sure to check the air pressure of your tires for the recommended inflation rating. Also, be certain that your tow vehicle is in good working order.

Install bimini top in its boot before towing. Also, remove and store cockpit and bow cover. Store cockpit carpet along with cockpit/mooring/bow covers in ski locker.

This can make it especially difficult to drive safely, as the hitch may be in danger of striking the road. Also, this situation can be caused by worn vehicle rear shock absorbers. One option is to install a set of air shocks which will assist in supporting the load. As a rule of thumb 5 to 7 percent of the total trailer load should be on the trailer tongue.

Check all lights to ensure they all work properly. You may find it helpful to ask someone to check your turn signals, brake lights, and towing lights while you remain in the vehicle. Be certain that the trailer winch cable is securely attached to the boat's bow eye and the winch cable lock is engaged.

Make sure the bow of the boat is snug against the bow stop at the winch stand.

It is a good idea to tie another line or secure an extra cable to the winch stand and boat bow eye as a backup system.

Be certain that your trailer is of rated capacity for the size and weight of your boat, including the weight for all fuel, water and gear. Your authorized Regal dealer can advise you on the proper trailer capacity and tongue weight ( the weight exerted on the rear of your vehicle).

Never use a bumper mounted trailer hitch. Always use a bolted or welded frame-mounted hitch, class 2 or 3. Consult your Regal dealer for more information.

Should your trailer be equipped with surge brakes, that is brakes on the trailer that cut in with a very slight delay when your brakes are applied, be sure to follow recommended service and maintenance instructions. Be sure that the trailer master cylinder is filled with the recommended fluid before towing your boat. Inspect the trailer brake lines for any leakage. If you ever notice brake fluid on the inside of the tires, you may have a wheel cylinder leaking. Consult a professional.

Never place your hands between the trailer hitch coupling and the hitch ball on your towing vehicle while hooking up. Be sure the tongue jack is in the full up position before departure. Be certain safety chains are crisscrossed and secured; do not allow them to drag on the road.

# TRAILER TERMINOLOGY

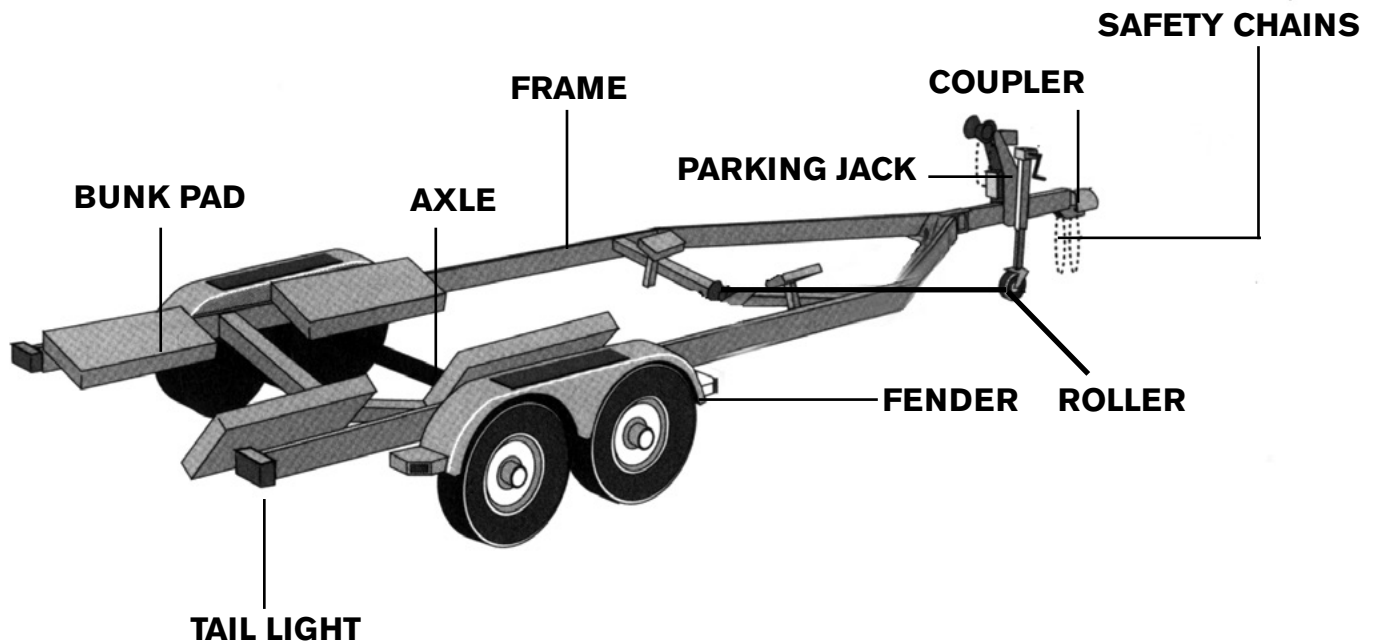

## TYPICAL TRAILER SHOWN

Be sure to buy a suitable set of tie downs which can be attached to the boats' stern eyes and the eyelets provided on most trailers. Tighten them securely and neatly fold up the extra strap material and secure it with tape so it doesn't loosen and dangle on the road.

Check the trailer lug nuts for the proper torque. Use a foot pound wrench and torque in a star sequence to the correct poundage as recommended by the trailer manufacturer. Torque the lug nuts at half the poundage on all nuts. Then set the torque wrench to the full poundage and fasten to the last foot poundage figure. Check the trailer tires often for voids, excessive wear or out of round tire conditions.

If the trailer seems to vibrate you may have a bad tire or one that is unbalanced. These wheels can be rebalanced at most automotive or tire shops. Never pull a boat on a patched tire. Buy a spare tire and wheel including a hub and wheel bearing assembly. Mount it on the trailer for speedy installation should a blow out occur.

Check the trailer harness often for signs of fraying. Check the harness connector for corrosion. Make sure the trailer harness when connected to the trailer has enough slack for turning

Check the wheel bearings for wear periodically by a professional.

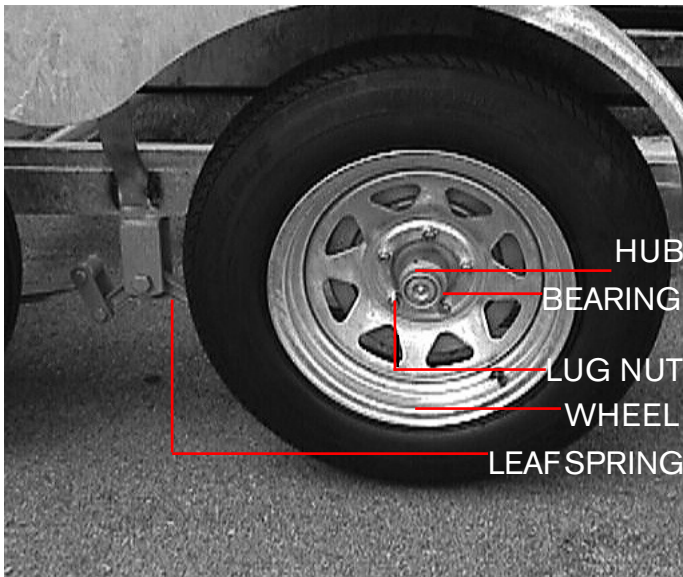

**TYPICAL WHEEL PARTS DESCRIPTION**

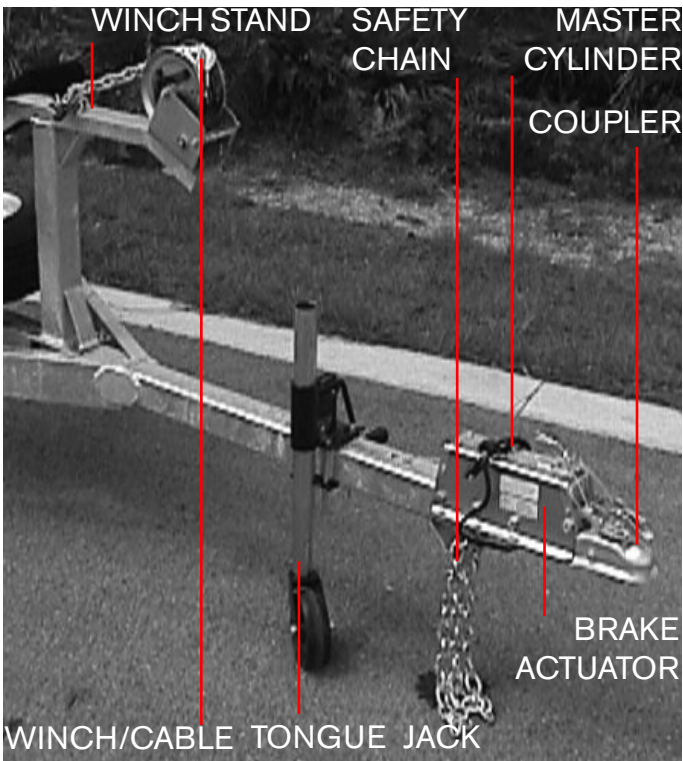

**TYPICAL TONGUE SECTION**

On most trailers, there is a zerk fitting on the wheel hub to add the proper lubricant to the wheel bearing with a grease gun. These wheel bearing waterproof covers for the bearings can be purchased at retail outlets.

## Spare Parts/Tools

Longer towing trips increase the need for special preparations. Sometimes these extended trips cover areas where it is difficult in locating repair parts due to a breakdown. Following is a checklist of recommended items to add a safety net to your trip.

### Trailer-

1. Trailer tire jack
2. Spare hub assembly including wheel bearings
3. Spare tire
4. Lug wrench
5. Jack stand
6. 12 volt air compressor-
7. Spare bearing protector
8. Extra tie-down straps
9. Trailer light bulbs
10. Brake pads and brake fluid
11. Grease gun

### Tow Vehicle-

1. Tool kit including necessary ratchet and sockets
2. Jumper cables
3. Extra fuses
4. Engine oil & transmission fluid
5. Wheel chocks
6. Highway flares
7. 12 volt spotlight- plugs into 12 volt acc. outlet
8. Flashlight & spare batteries
9. Waterless hand cleaner and rags
10. Electrical connectors and crimpers
11. Low voltage electrical tester



## Launching

Serious accidents can occur at the launching ramp. Therefore, it is imperative you be alert and attentive during launching and docking activities. Study the ramp area and surrounding water for any potential hazards, such as a short ramp or one with a drop off at the end. If you are uncertain of the conditions, ask someone else who has just used the ramp if there are any peculiarities to the area.

Install the drain plug. Attach 2 lines, one each at the bow and stern, to control your boat once it is off the trailer. If you need additional fenders to keep the sides of the boat from banging against the ramp walls, use those as well.

Unhook the stern tie-downs and the winch line to the bow. Unplug the trailer harness connector so the hot trailer light bulbs won't blow out when they come in contact with water.

When backing in, have someone assist, giving the palms up stop signal when the boat is in deep enough water to float off, or when the rear wheels of your vehicle approach the water's edge.

After your boat is floating freely, position it clear of the trailer before pulling out of the water. If there is no one to help you, secure one of the lines you've attached from the boat to the dock and use the other line to pull the boat off trailer. The process is easier with 2 people.



## WARNING

AVOID SERIOUS INJURY!  
BOAT RAMPS ARE VERY SLIPPERY.  
DO NOT ATTEMPT TO WALK OR STAND  
ON AN ANGLED BOAT RAMP!



## WARNING

AVOID SERIOUS BODILY INJURY!  
KEEP BODY PARTS  
CLEAR OF THE WINCH  
WHEN IN USE.



## CAUTION

AVOID LOSING VEHICLE TRACTION!  
DO NOT ALLOW REAR WHEELS TO  
ENCOUNTER SAND OR SLIPPERY  
CONCRETE CONDITIONS!

## Loading



The most important thing to remember when pulling your boat out of the water is that often

the ramp will be crowded. As you approach the ramp, make a visual inspection of the traffic and people, both at the ramp and all around you. This is an important time to use caution, courtesy, and common sense. While you may feel it's your next turn, another boater may not be as courteous. Don't insist on your rightful place in line; it could lead to disastrous consequences in the confines of a crowded boat ramp. If there is any perceived danger, stand off until you can safely approach the ramp. Back your trailer down to the water's edge. At this point it is a good idea to let a sufficient amount of line out of the winch to reach the bow eye. Make sure you disconnect the trailer harness to keep the hot bulbs from blowing out due to being subjected to cold water. When replacing lights if possible shop for LED's which are a sealed unit without any filament and they usually enjoy a extended life.

On roller or bunk style trailers back up until the aft roller is just at the water level. This allows you to hook up the winch cable and to start cranking the boat on to the trailer properly. This method gives you a good starting point and helps keep the boat centered on the trailer as it is reloaded. It may be necessary to further back the trailer into the water, permitting easier cranking of the boat on the trailer.

With the bow snug against the roller start to crank the boat up on to the trailer. Make sure the hull bottom or keel stays in the center of each roller as it is being cranked on the trailer. Double check to ensure the hitch is locked tight on the vehicle ball.

Before towing the vehicle connect up the wiring harness to the bow receptacle for the boat transom lights to operate. These lights are high on the boat transom providing additional visibility from the rear while towing in highway traffic, especially at night.

This harness features a raised alignment notch as



RECEPTACLE



shown in the male receptacle. When plugging in the male plug to the female receptacle make sure the 2 notches line up before inserting the plug into the receptacle. *Note that the other end of the harness features wires without ends. Using for the first time requires these wires be spliced into the correct trailer wires (color coded) for the running and brake lights to function. Use connectors that permit removing the harness wire connectors from the trailer wires. Keep the receptacle protected with the cap when not in use.*

# Chapter 12

## Glossary & Index

### Overview

Below is a brief list of nautical terminology. For more detailed glossaries we recommend you check your local library, book retailer, marine store or internet.

### Glossary

**Abeam:** at right angles to the fore and aft line and off the boat

**Aboard:** on or in the boat

**Above:**the part of the boat on a vessel which is above the interior of the boat

**Aft, After::** aft is the boat section toward the stern or back of the boat

**Amidships:** toward the center of the boat from either side to side or rear to front

**Beam:** the width of a boat at its widest part

**Bilge:** the lower interior of the hull of the boat

**Bitter end:** the end of a line also the end of an anchor line

**Bow:** the front, or forward part of the boat

**Bulkhead:** the vertical partition or wall of a boat

**Cast off:** to let go or release

**Chine:** the line fore and aft formed by the intersection of the side and bottom of the boat

**Chock:** deck fitting used to secure or guide anchor or tie lines

**Cleat:** deck fitting with protruding arms around which lines are secured

**Cockpit:** the seating space used to accommodate passengers

**Cuddy:** a small cabin in the fore part of the boat

**Deck:** the open flooring surface on which crew and passengers walk

**Draft:** the depth from the waterline of the boat to the lowest part of the boat, which indicates how much water is required to float the boat

**FasTrac-** a proven hull bottom design which incorporates a full, mid-beam step that reduces drag by forcing air under the hull to decrease drag and friction.

**Fathom:** a measurement of depth; one fathom equals six feet

**Fender:** a cushion hung from the side of a boat to prevent it from rubbing against a dock or against other boats.

Fend off: to push off to avoid sharp contact with dock or other vessel

Fore: the part of the boat toward the bow or front

Freeboard: the height of the top side from the waterline to the deck at its shortest point (The distance from sheer or gunwale to the water).

Gunwale: rail or upper edge of the side of the boat

Head: toilet

Hull: the part of the hull from the deck down

Keel: the lowest point of a boat; the backbone of the vessel

Knots: a measurement of speed indicating nautical miles per hour

Lee: the side opposite that from which the wind is blowing; the side sheltered from the wind

Leeward: the direction toward which the wind is blowing

PFD: personal flotation device; required for each person aboard

Port: the left side of the boat when facing forward (an easy way to remember the difference between "port" and "starboard" is that both "port" and "left" have four letters)

Shank: the main body of an anchor

Sheer: the curve of the boat's deck from fore to aft when seen from the side

Starboard: the right side of the boat when facing forward

Stern: the aft end of the boat

Stern drive: an inboard/outboard (I/O) unit

Stringer: strengthening integral unit fastened from fore to aft inside the hull and fiberglass encapsulated for added strength: much like the skeleton system of our body

## INDEX

<b>A</b>		<b>C</b>	
Accidents	37	California EVAP Regulation	2
Accident Reporting	37	California Spark Ignition Information	2
Acrylics	170	Canvas	150
Anchor Light	29		159
Anchoring	139	Capacity Plate (NMMA)	7
Aquatic Invasive Species	144	Carbon Monoxide	33
Audible Alarms	77	Cardiopulmonary Resuscitation	142
Automatic Fire Extinguisher	145	Cockpit Sea-Grass Mat	153
		Controls	87
			116
<b>B</b>		<b>D</b>	
Ballast (Bladder) Bags	90	Dealer Responsibilities	12
Battery	56	Decommissioning	171
	177	Direct Current Protection	59
Battery Charger	61	Distress Signals	27
Battery Switch	60	Diver's Flag	39
Bilge Pump	147	Docking Lights	154
Boating Under The Influence	36	Dock Line Basics	132
Bottom Blocking	194	Drain Plug	194
Bow Filler Cushion	148		
Bow Walk Through Doors	149	<b>E</b>	
Bridge Clearance	48	EPIRB	11
Buoys	45	Electrical	52
		Electric Shock Drowning (ESD)	143
		Electronics	78
			94
			106
			154
		Emergencies	141
		Engine-Stern Drive	76
		Engine-Starting Stern Drive	82
		Engine-Outboard	98
		Engine-Starting Outboard	108
		Environmental Awareness	143
		Exhaust	33
		Extension Cord Usage	103



F		I	
Fender Clips	155	Ignition Panel/Switch	82
Fenders	134	Index	204
Fiberglass	171	Instruments	78
Filters	68		84
	123	Interior Fabrics	171
Fire Port	65		
	145	K	
Fire Extinguishers	24	Knots	141
	145		
First Aid	142	L	
Fishing	39	Labels (Safety)	18
Float Plan	9		210
Forward Drive Propulsion	89	Ladder	156
Fueling	131	Lighting	63
Fuel System	65	Life Raft	32
	108	Loading	20
Fuse Panel (DC)	63		21
		Law Of Salvage	140
G		Lubrication-Engine	80
GFCI	84		121
	181		83
Galvanic Corrosion	87	Lubrication- Stern Drive	121
Galvanic Isolator Warning Label	59		
Garbage Placard	31	M	
Gel Coat Maintenance	171	Maneuvering	134
General Boating Safety	19	Maintaining PFD'S	24
Getting Underway	130	Masthead Light	29
Glossary	202	Metal Cleaning	174
		Minimum Required Equipment	32
H			
Helm Controls-Stern Drive	69		
Helm Controls-Outboard	105		
HIN	7		
Horn	28		
Hull Bottom	175		
Hypothermia	142		

N		S	
NMEA 2000 Network	75	SeaDek	139
Navigational Aids	45	Seating	20
Navigation Lights	28		215
	29		216
Navigation Rules	41	Shallow Water Operation	138
Neutral Safety Switch	85	Shifting-Remote Control	88
Night Running	48	Sound Producing Devices	28
		Spaghetti Matts	170
O		Spring Line	133
Oil Spills	30	Stopping	136
Overloading	20	Stern Line	132
	21	Stereo	73
Owner's Information Packet	7	Surf Pumps	91
Owner's Registration	12	Surf Tabs	92
Owner's Responsibilities	12	Surf Water Sports Control Manual	94
P		T	
Personal Flotation Devices	22	Table	162
Plastics	169	Table Of Contents	5
Pollution Regulations	30	Tachometer	78
Portable Fire Extinguishers	24	Technical	208
PowerTower	157	Towing	140
Power Trim	137		197
Pre-departure questionnaire	130	Trim Angle	137
Propellers	81	Trim Switch	164
	89	Troubleshooting	185
	196		
		U	
R		Underwater Lighting	165
Radio Communications	28	Upholstery	169
Recommissioning	196		
Remote Stereo Control	159		
Required Safety Equipment	32		
Right Of Way	41		
Rules Of The Road	43		
	44		

## V

Ventilation	70
Visual Distress Signals	26

## W

Water Sports	39
Warning Labels	18
Warranty	14
Weather	40
Winterizing	193
Wiring Color Codes	53

## XYZ

Zinc Anodes	184
-------------	-----

# Chapter 13

## Technical

### NOTICE

The following technical information and drawings can be an aid in troubleshooting electrical and mechanical problems along with the charts located in the troubleshooting chapter.

*Note that all product specifications, models, standard and optional equipment, systems, along with technical information and drawings is subject to change without notice.*

***Note that drawings designated as LS series relate to LS2, LS2Surf, & LX2 models.***

For more information contact your nearest authorized Regal dealer. For the location of your nearest authorized dealer call 407-851-4360 or visit the web-site at [www.Regalboats.com](http://www.Regalboats.com).

Your Regal dealer has received special factory training on the entire product line and his services should be employed to solve technical problems.

# TYPICAL DOMESTIC COMPLIANT FUEL SYSTEM LS SERIES

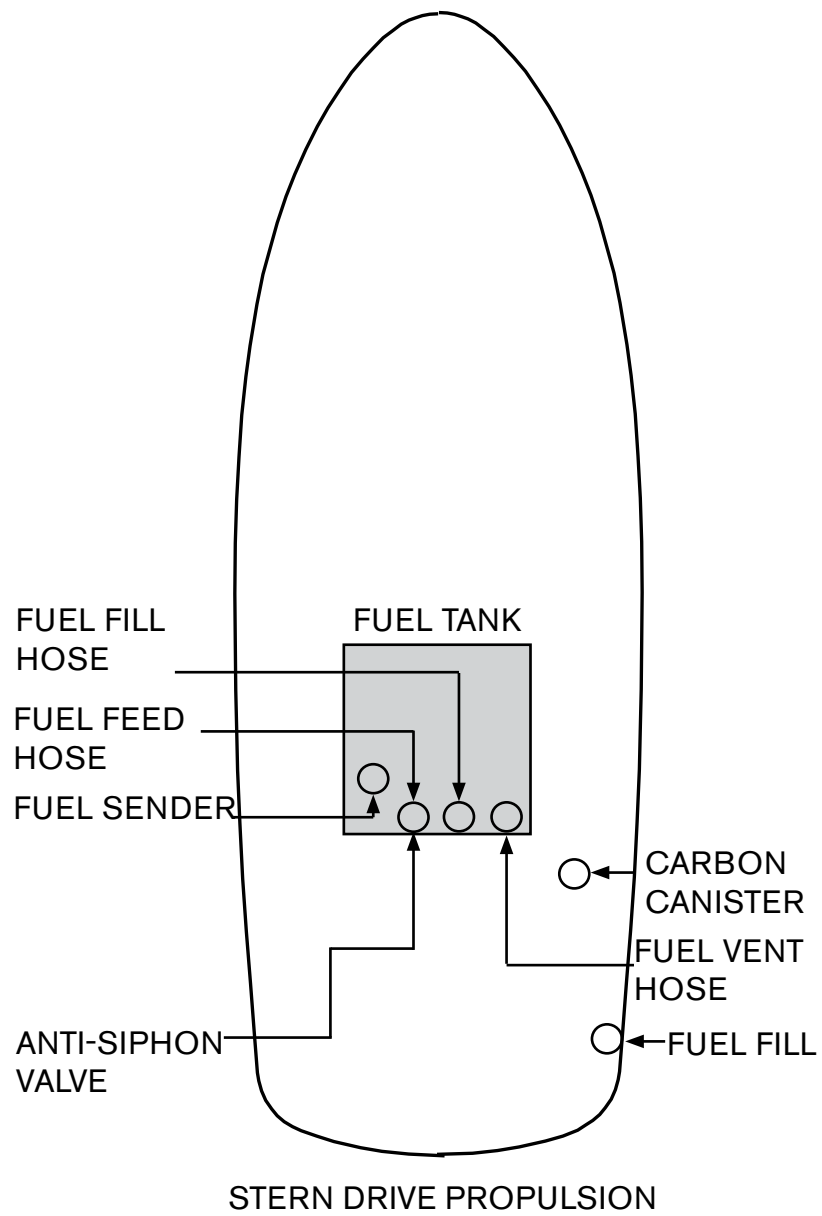



# TYPICAL LABELS & LOCATIONS

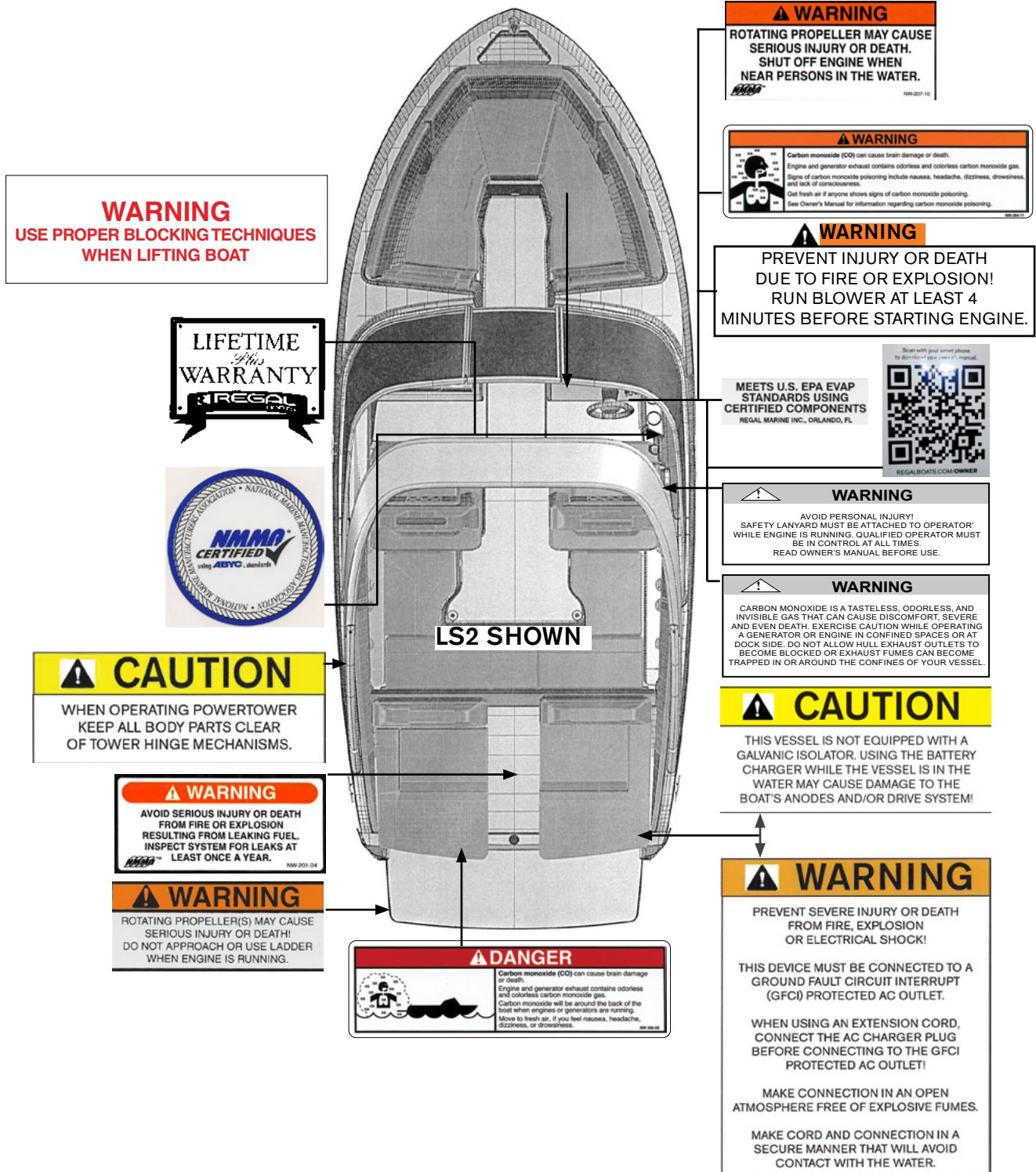

**WARNING**  
USE PROPER BLOCKING TECHNIQUES  
WHEN LIFTING BOAT

LIFETIME  
WARRANTY  
REGAL



**CAUTION**  
WHEN OPERATING POWERTOWER  
KEEP ALL BODY PARTS CLEAR  
OF TOWER HINGE MECHANISMS.

**WARNING**  
AVOID SERIOUS INJURY OR DEATH  
FROM FIRE OR EXPLOSION  
RESULTING FROM LEAKING FUEL.  
INSPECT SYSTEM FOR LEAKS AT  
LEAST ONCE A YEAR.

**WARNING**  
ROTATING PROPELLER(S) MAY CAUSE  
SERIOUS INJURY OR DEATH!  
DO NOT APPROACH OR USE LADDER  
WHEN ENGINE IS RUNNING.

**⚠ DANGER**  
Carbon monoxide (CO) can cause brain damage or death.  
Engine and generator exhaust contains odorless and colorless carbon monoxide gas.  
Carbon monoxide will be around the back of the boat when engines or generators are running.  
Move to fresh air, if you feel nausea, headache, dizziness, or drowsiness.

**⚠ WARNING**  
ROTATING PROPELLER MAY CAUSE  
SERIOUS INJURY OR DEATH.  
SHUT OFF ENGINE WHEN  
NEAR PERSONS IN THE WATER.

**⚠ WARNING**  
Carbon monoxide (CO) can cause brain damage or death.  
Engine and generator exhaust contains odorless and colorless carbon monoxide gas.  
Signs of carbon monoxide poisoning include nausea, headache, dizziness, drowsiness and lack of consciousness.  
Get fresh air if anyone shows signs of carbon monoxide poisoning.  
See Owner's Manual for information regarding carbon monoxide poisoning.

**⚠ WARNING**  
PREVENT INJURY OR DEATH  
DUE TO FIRE OR EXPLOSION!  
RUN BLOWER AT LEAST 4  
MINUTES BEFORE STARTING ENGINE.

MEETS U.S. EPA EVAP  
STANDARDS USING  
CERTIFIED COMPONENTS  
REGAL MARINE INC., ORLANDO, FL

**⚠ WARNING**  
AVOID PERSONAL INJURY!  
SAFETY LANYARD MUST BE ATTACHED TO OPERATOR  
WHILE ENGINE IS RUNNING. QUALIFIED OPERATOR MUST  
BE IN CONTROL AT ALL TIMES.  
READ OWNER'S MANUAL BEFORE USE.

**⚠ WARNING**  
CARBON MONOXIDE IS A TASTELESS, ODORLESS, AND  
INVISIBLE GAS THAT CAN CAUSE DISCOMFORT, SEVERE  
AND EVEN DEATH. EXERCISE CAUTION WHILE OPERATING  
A GENERATOR OR ENGINE IN CONFINED SPACES OR AT  
DOCK SIDE. DO NOT ALLOW HULL EXHAUST OUTLETS TO  
BECOME BLOCKED OR EXHAUST FUMES CAN BECOME  
TRAPPED IN OR AROUND THE CONFINES OF YOUR VESSEL.

**⚠ CAUTION**  
THIS VESSEL IS NOT EQUIPPED WITH A  
GALVANIC ISOLATOR. USING THE BATTERY  
CHARGER WHILE THE VESSEL IS IN THE  
WATER MAY CAUSE DAMAGE TO THE  
BOAT'S ANODES AND/OR DRIVE SYSTEM!

**⚠ WARNING**  
PREVENT SEVERE INJURY OR DEATH  
FROM FIRE, EXPLOSION  
OR ELECTRICAL SHOCK!  
THIS DEVICE MUST BE CONNECTED TO A  
GROUND FAULT CIRCUIT INTERRUPT  
(GFCI) PROTECTED AC OUTLET.  
WHEN USING AN EXTENSION CORD,  
CONNECT THE AC CHARGER PLUG  
BEFORE CONNECTING TO THE GFCI  
PROTECTED AC OUTLET!  
MAKE CONNECTION IN AN OPEN  
ATMOSPHERE FREE OF EXPLOSIVE FUMES.  
MAKE CORD AND CONNECTION IN A  
SECURE MANNER THAT WILL AVOID  
CONTACT WITH THE WATER.

# LS SERIES TOP VIEW



PROPRIETARY AND CONFIDENTIAL. All drawings, text and images of Regal Marine Industries and its subsidiaries are the property of Regal Marine Industries. All rights reserved. Reproduction in part or in whole without the written permission of Regal Marine Industries is prohibited.

 <b>REGAL MARINE INDUSTRIES</b> <small>ORLANDO, FL 32836-3800 TEL: 407.346.3000 WWW.REGALMARINE.COM</small>		<small>ALL RIGHTS RESERVED</small>	
<b>LS2 (CF) General Arrangements</b>			
DATE	REVISION	PKT#	
6/10/2019	-	2 OF 2	
DESIGN BY	APPROVED BY	DRAWING NO.	
TMH	Dennis R.	2	

# TYPICAL LS2 PROFILE



PROPRIETARY AND CONFIDENTIAL.  
 THIS INFORMATION CONTAINED IN THIS DRAWING IS THE SOLE PROPERTY OF REGAL MARINE INDUSTRIES. ALL RIGHTS RESERVED.  
 PERMISSION TO REPRODUCE OR TRANSMIT IN ANY FORM OR BY ANY MEANS IS PROHIBITED.

 <b>REGAL MARINE INDUSTRIES</b> ONE ANDY ROAD, SUITE 3000 FORT MYERS, FL 33908 TEL: (813) 938-2800			
DRAWING TITLE: <b>LS2 (CF) General Arrangements</b>			
DATE:	REVISION:	SCALE:	TRIAL NO.:
6/10/2019	-	1 OF 2	1
DRAWN BY:	APPROVED BY:		
TMH	Dennis R.		

## TYPICAL LX2 PROFILE



*Note that all product specifications, models, standard and optional equipment, systems, along with technical information and drawings is subject to change without notice.*

# DIMENSIONS

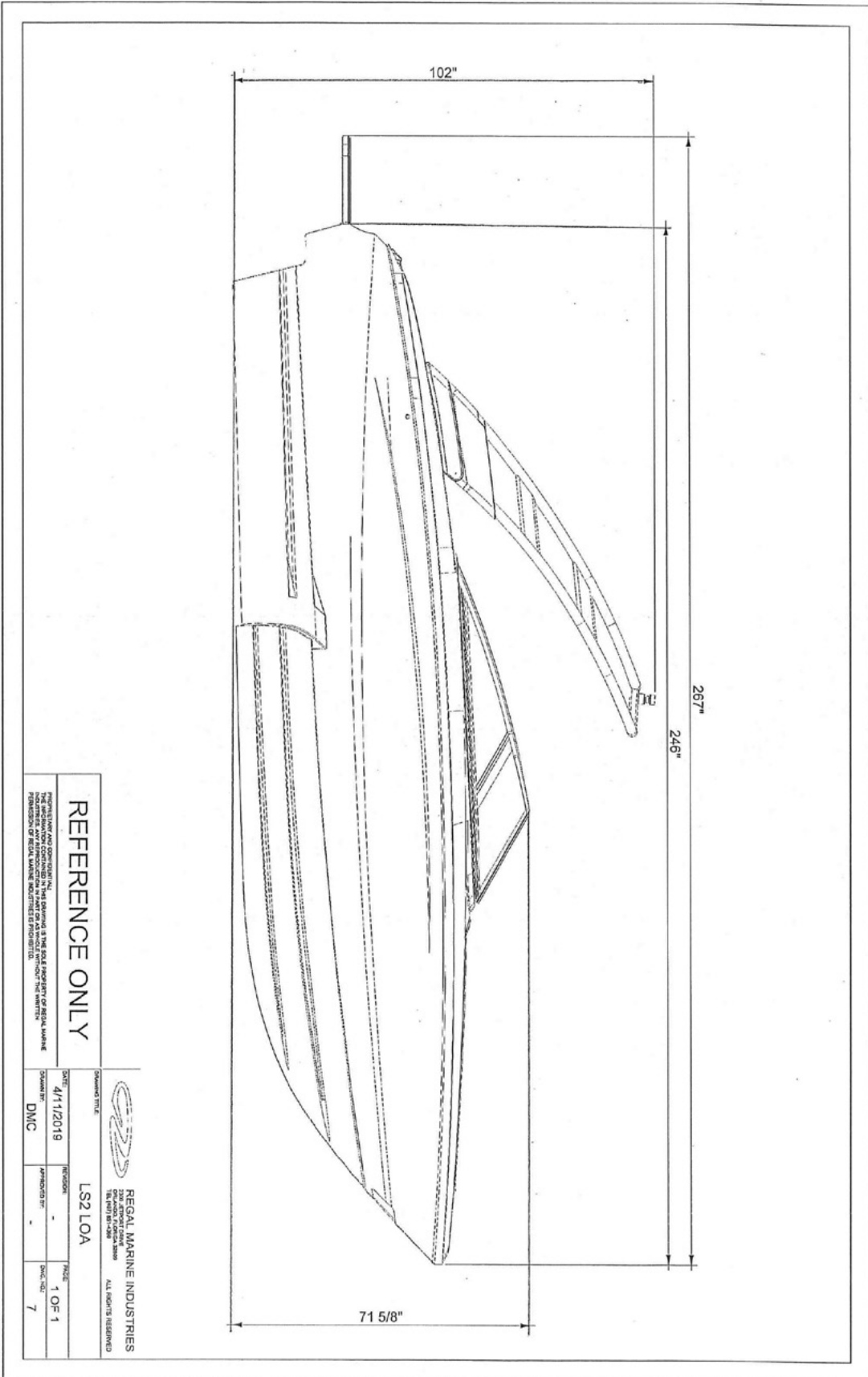

**REFERENCE ONLY**

REGAL MARINE INDUSTRIES  
2000 WEST 10TH AVENUE  
DENVER, CO 80202  
TEL: 303.733.0000  
WWW.REGALMARINE.COM

 <b>REGAL MARINE INDUSTRIES</b> <small>2000 WEST 10TH AVENUE DENVER, CO 80202 TEL: 303.733.0000 WWW.REGALMARINE.COM</small>		<small>ALL RIGHTS RESERVED</small>	
<small>DRAWING TITLE</small>	<b>LS2 LOA</b>	<small>DATE</small>	<b>4/1/2019</b>
<small>DRAWN BY</small>	<b>DMC</b>	<small>APPROVED BY</small>	-
<small>PAGE</small>	<b>1 OF 1</b>	<small>DWG. NO.</small>	<b>7</b>

*Note that all product specifications, models, standard and optional equipment, systems, along with technical information and drawings is subject to change without notice.*



# LS2 NORTH AMERICAN SEATING OCCUPANCY

15.5" W X 29.5" L  
Allowance Per Person

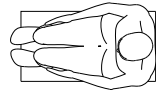

Domestic Seating Occupancy: 12 Persons

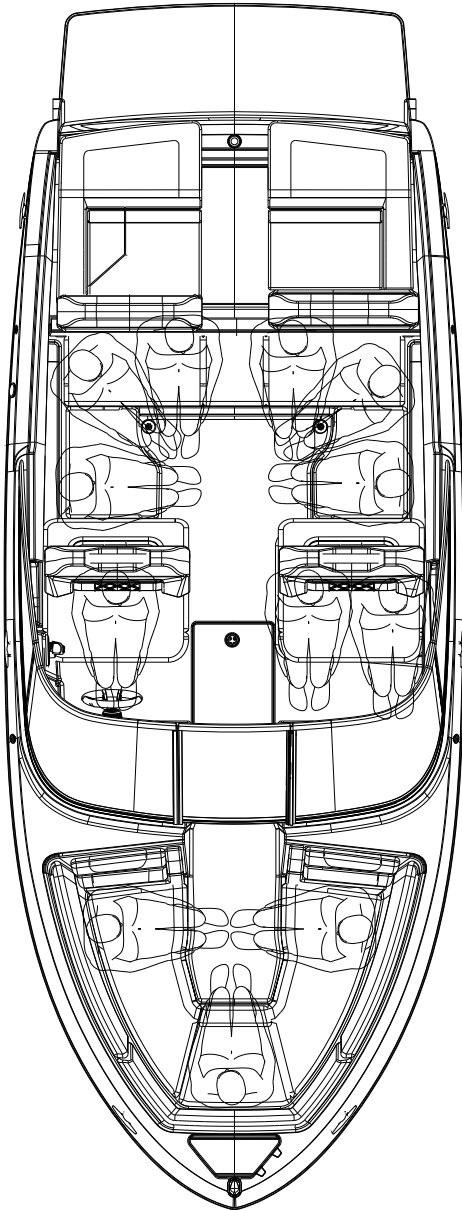

REGAL MARINE AND COY. INC. IS THE SOLE ENGINEER OF RECORD AND  
INDUSTRIES AND REPRESENTS IN PART OR ADVISES AND APPROVES THE SEATING  
CAPACITY OF THIS VESSEL. THIS SEATING CAPACITY IS BASED ON THE  
ASSUMPTIONS OF 15.5" W X 29.5" L PER PERSON.

 <b>REGAL MARINE INDUSTRIES</b> 2000 ALBANY DRIVE ALBANY, NY 12212 TEL: (518) 534-1800		ALL RIGHTS RESERVED	
<b>LS2 (CF) Seating Capacity</b>			
DATE	REVISION	NO.	OF
6/10/2019	-	1	1
DESIGNED BY	APPROVED BY	DATE	NO.
TMH	Dennis R.	5/26/2019	3

# LS2 CE SEATING OCCUPANCY

15.5" W X 29.5" L  
Allowance Per Person

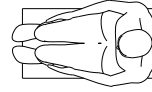

CE Seating Occupancy: 10 Persons

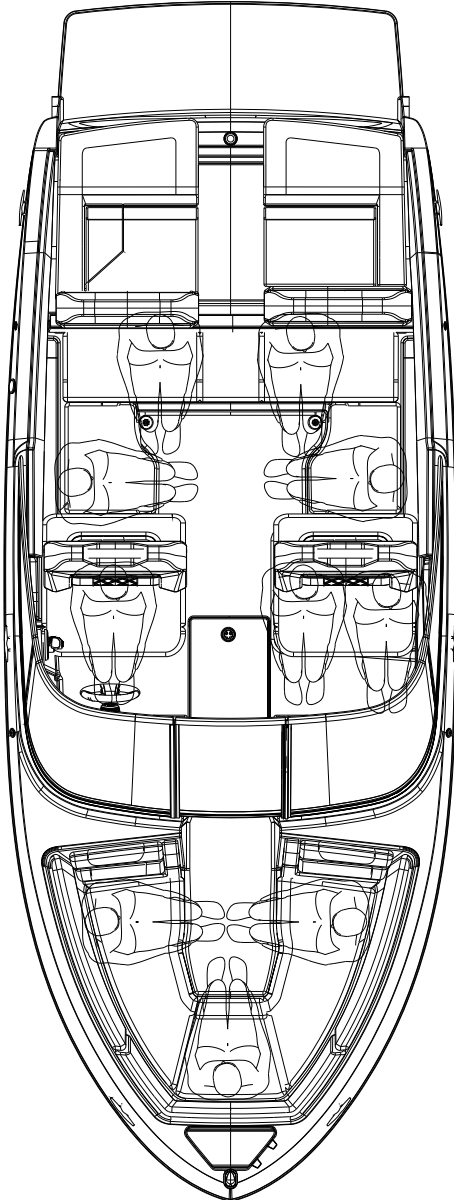

*Note that CE life raft storage is designated as the center of the cockpit.*

REGAL MARINE INDUSTRIES, INC. IS NOT RESPONSIBLE FOR ANY DAMAGE TO THE BOAT OR EQUIPMENT CAUSED BY THE USE OF THIS SEATING CAPACITY. ALWAYS WEAR YOUR SEATBELT AND PLEASE DON'T DRINK AND DRIVE. ALWAYS WEAR YOUR SEATBELT AND PLEASE DON'T DRINK AND DRIVE. ALWAYS WEAR YOUR SEATBELT AND PLEASE DON'T DRINK AND DRIVE.

 <b>REGAL MARINE INDUSTRIES</b> <small>ORLANDO, FLORIDA 32809</small> <small>ALL RIGHTS RESERVED</small>	
DRAWING TITLE	
<b>LS2 (CF) Seating Capacity</b>	
DATE	REVISION
6/10/2019	-
DRAWN BY	APPROVED BY
TMH	Dennis R.
PAGE	DWG. NO.
1 OF 1	3

# TYPICAL LS2 SURF SYSTEM BALLAST BAG HOSE ROUTING 1

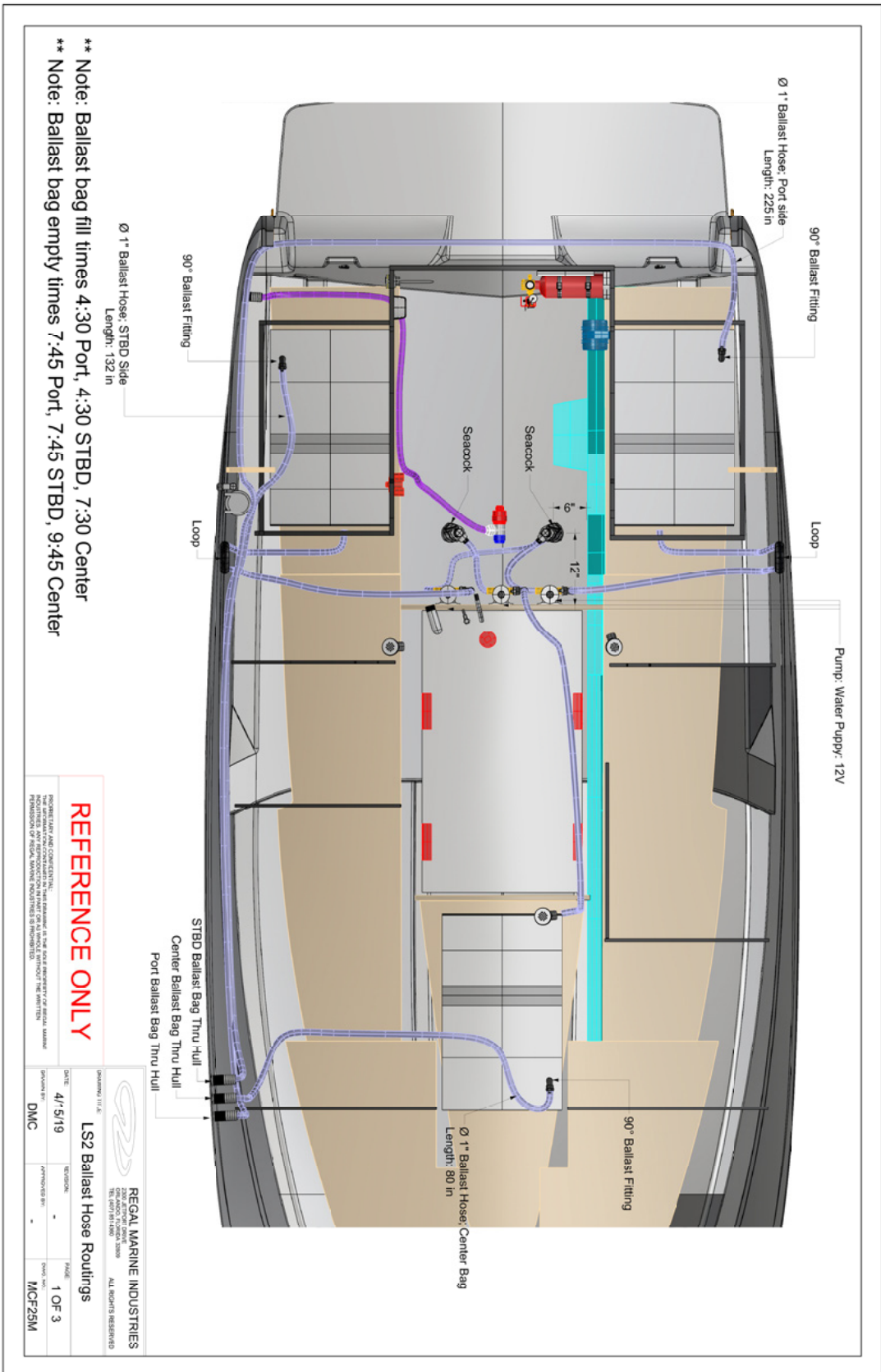

# TYPICAL LS2 SURF SYSTEM HOSE ROUTING 2

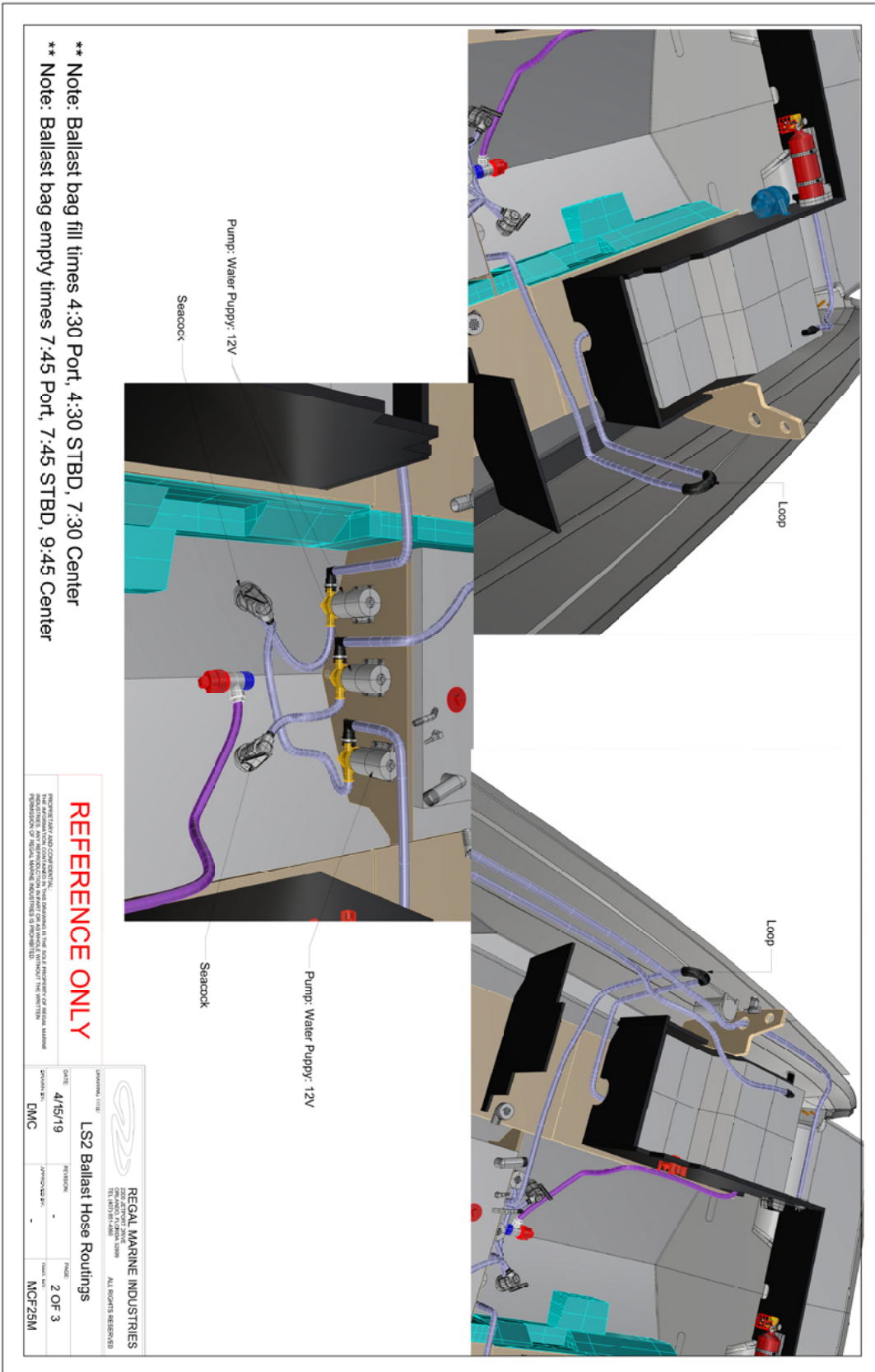

# TYPICAL LS2 SURF SYSTEM HOSE ROUTING 3

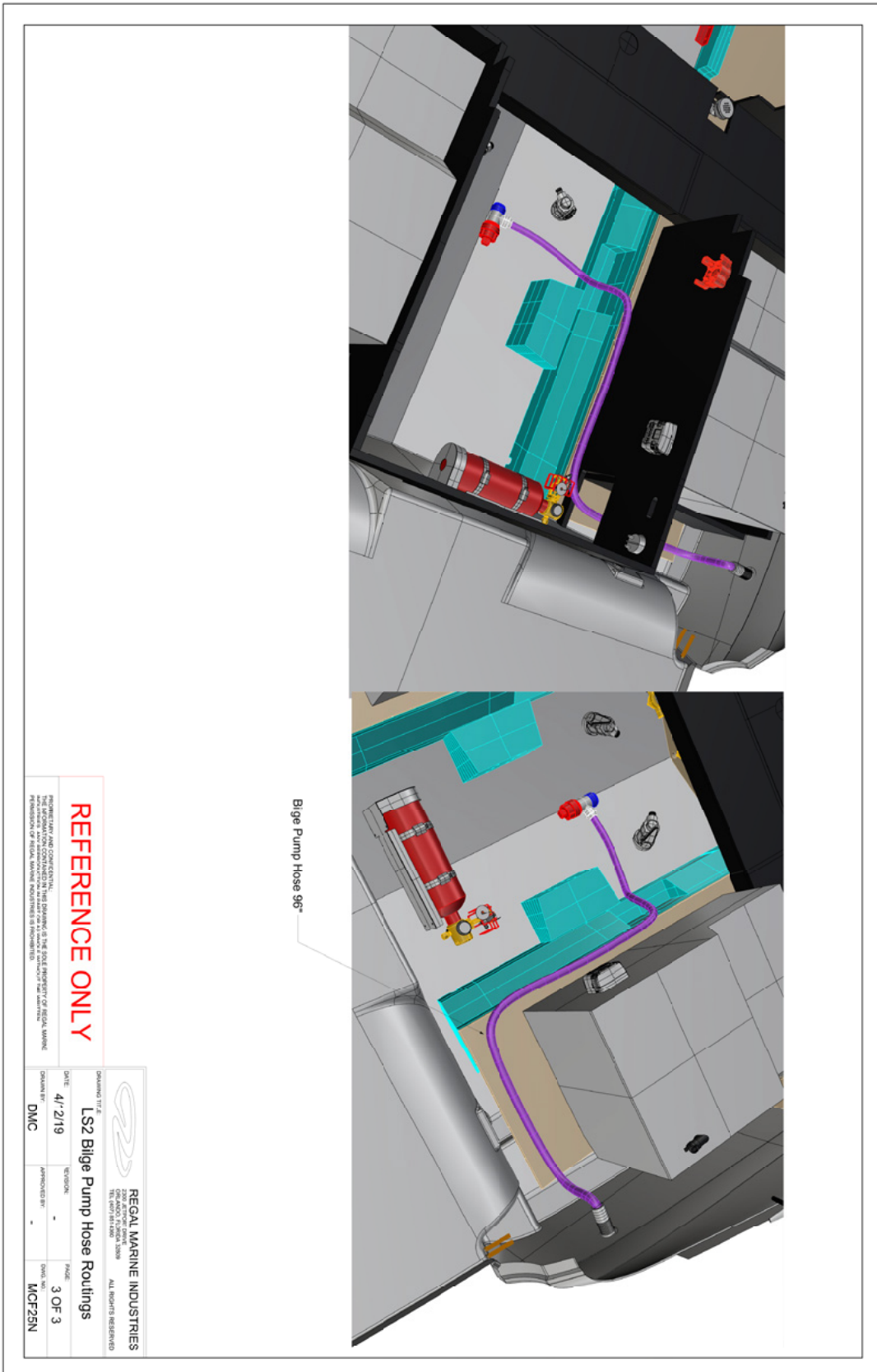

**REFERENCE ONLY**

PERMITTING AND CONFIDENTIAL. THIS DOCUMENT IS UNCLASSIFIED AND IS BEING RELEASED IN FULL TO THE PUBLIC. REGAL MARINE INDUSTRIES, A DIVISION OF REGAL MARINE INDUSTRIES LLC, IS PROVIDING THIS INFORMATION AS A SERVICE TO OUR CUSTOMERS. REGAL MARINE INDUSTRIES, A DIVISION OF REGAL MARINE INDUSTRIES LLC, IS PROVIDING THIS INFORMATION AS A SERVICE TO OUR CUSTOMERS.

 <b>REGAL MARINE INDUSTRIES</b> <small>DESIGN • MANUFACTURE • SERVICE</small> <small>TEL: 800.833.8888</small> <small>ALL RIGHTS RESERVED</small>	
<small>DRAWING TITLE</small> <b>LS2 Bilge Pump Hose Routings</b>	<small>DATE</small> <b>4/7/2019</b>
<small>DRAWN BY</small> <b>DMC</b>	<small>APPROVED BY</small> -
<small>REVISION</small> -	<small>PAGE</small> <b>3 OF 3</b>
<small>DMC NO.</small> <b>MC25N</b>	



# TYPICAL LS2 SERIES SURF SUMP

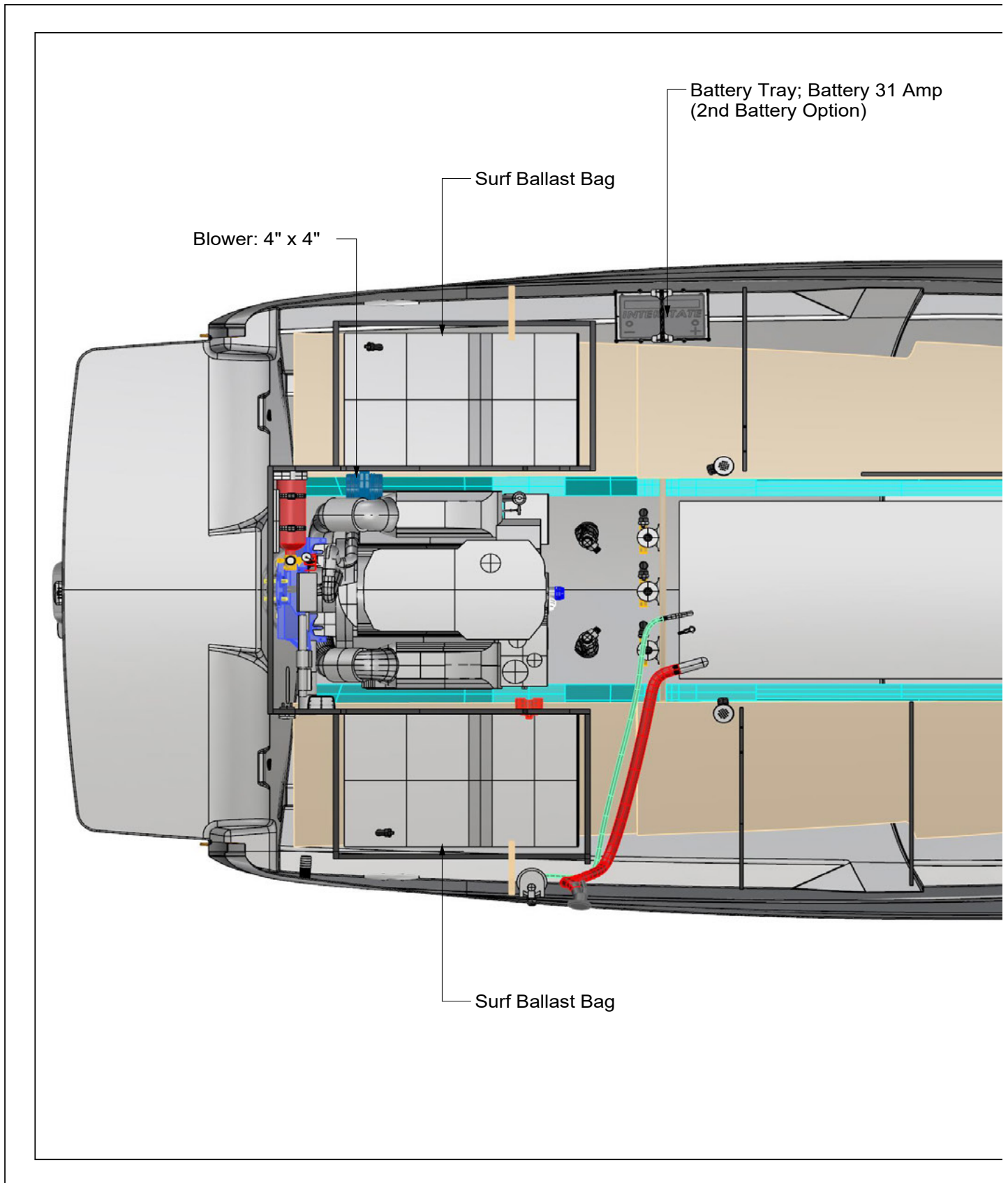

# TYPICAL LS SUMP-NON-SURF

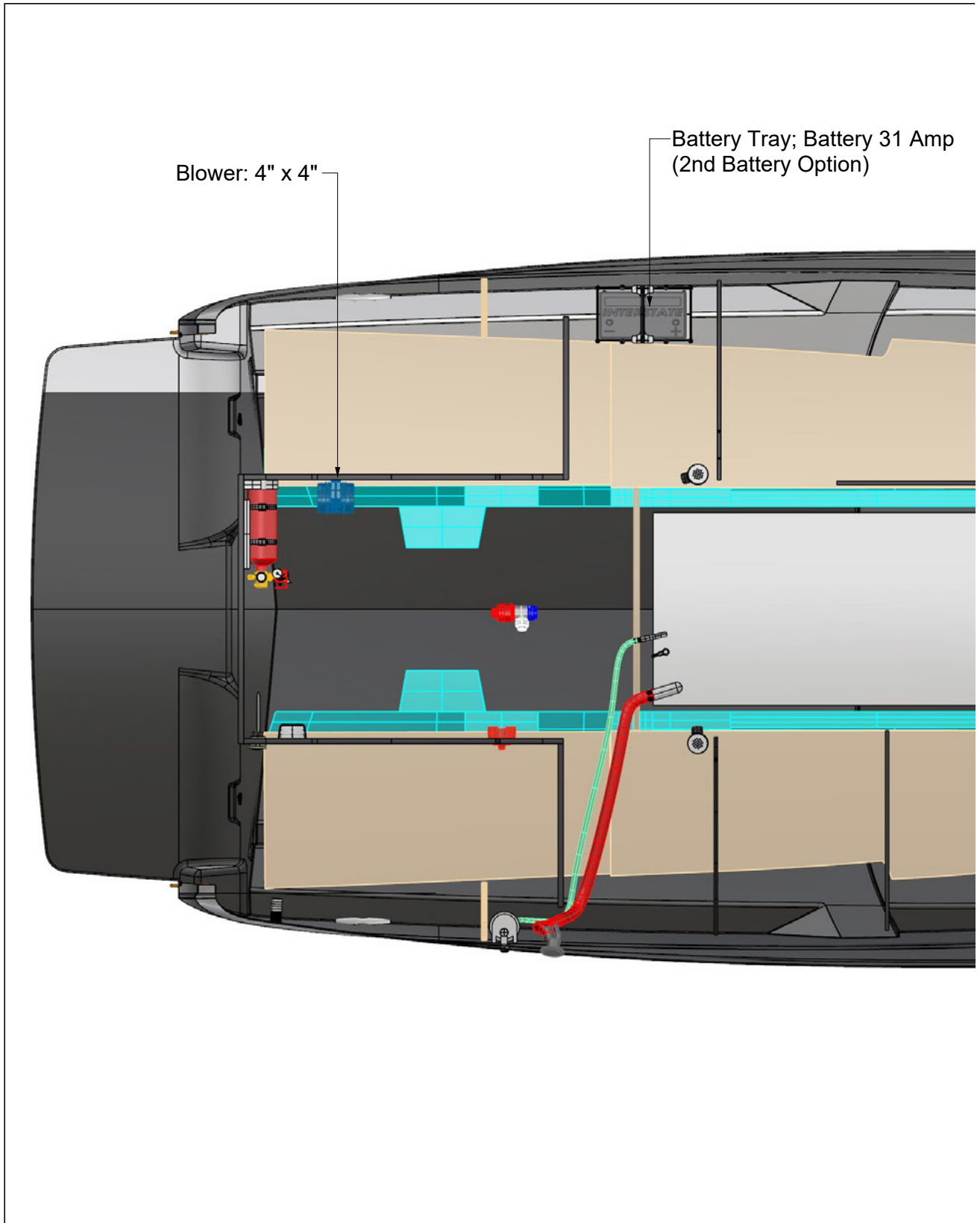

# TYPICAL LX2 OUTBOARD SUMP

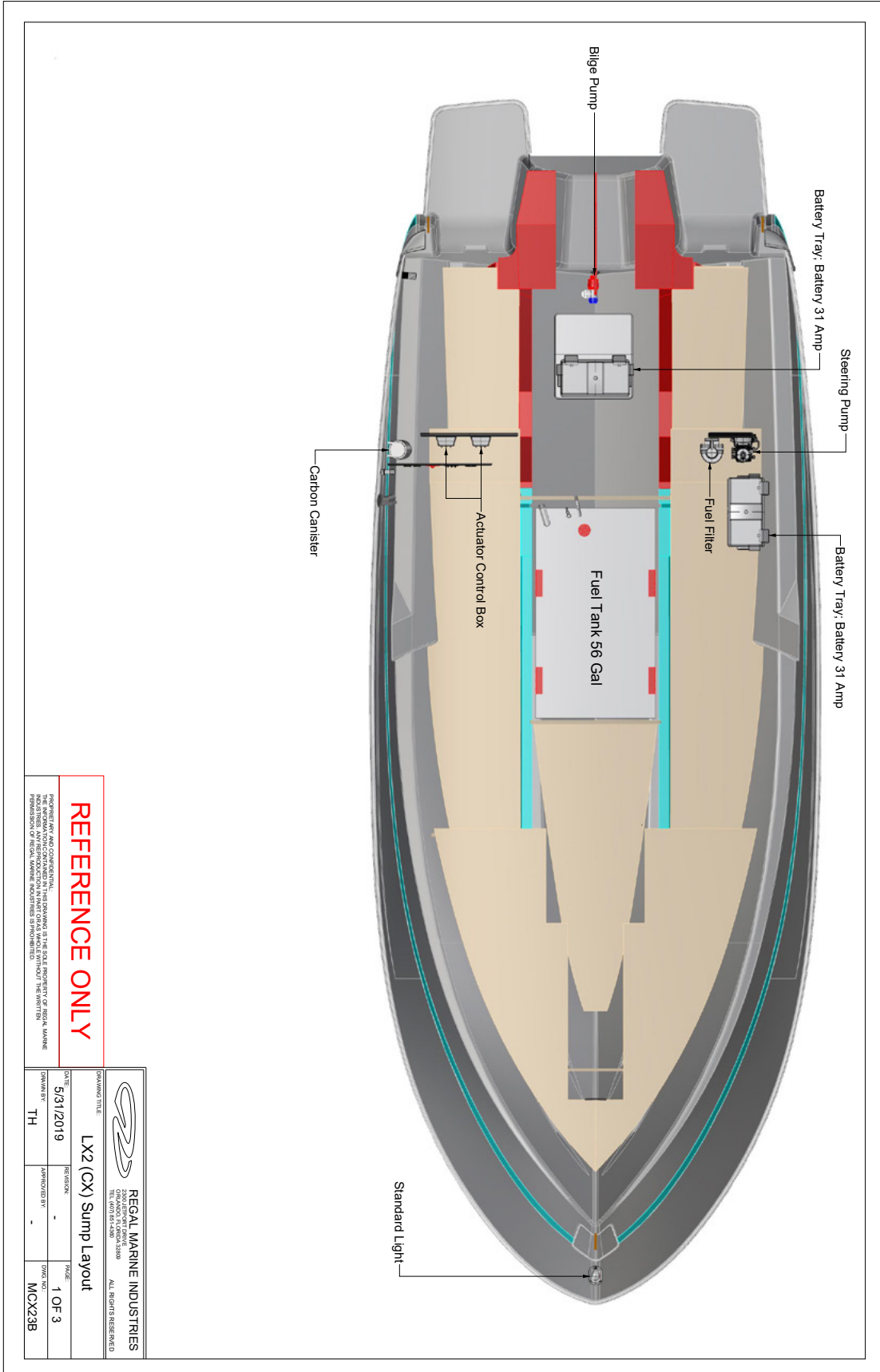

**REFERENCE ONLY**

PROPERTY AND COPYRIGHT:  
 THE INFORMATION CONTAINED IN THIS DRAWING IS THE SOLE PROPERTY OF REGAL MARINE  
 INDUSTRIES. REPRODUCTION OR TRANSMISSION OF THIS INFORMATION IN ANY FORM OR BY ANY  
 MEANS WITHOUT THE WRITTEN PERMISSION OF REGAL MARINE INDUSTRIES IS PROHIBITED.

 <b>REGAL MARINE INDUSTRIES</b> 2000 W. STATE ST. SUITE 2000 TALLAHASSEE, FL 32310-3600 TEL: (904) 871-1400 FAX: (904) 871-1400	
DRAWING TITLE	
LX2 (CX) Sump Layout	
DATE	5/31/2019
DESIGNER	-
APPROVED BY	-
TH	
TRIAL NO.	1 OF 3
MODEL NO.	MGX23B

# HULL HARNESS

**PROPRIETARY RIGHTS**  
 THIS DOCUMENT CONTAINS PROPRIETARY INFORMATION AND DESIGN DISCLOSED HEREIN WOULD BE UNLAWFUL. THE INFORMATION AND DESIGN DISCLOSED HEREIN WERE DEVELOPED BY BENTON ELECTRONICS INC. FOR THE USE OF THE U.S. NAVY. ANY REPRODUCTION OR TRANSMISSION OF THIS DOCUMENT OR THE INFORMATION CONTAINED HEREIN WITHOUT THE WRITTEN PERMISSION OF BENTON ELECTRONICS INC. IS PROHIBITED. THIS DOCUMENT IS TO BE RETURNED TO BENTON ELECTRONICS INC. UPON REQUEST.

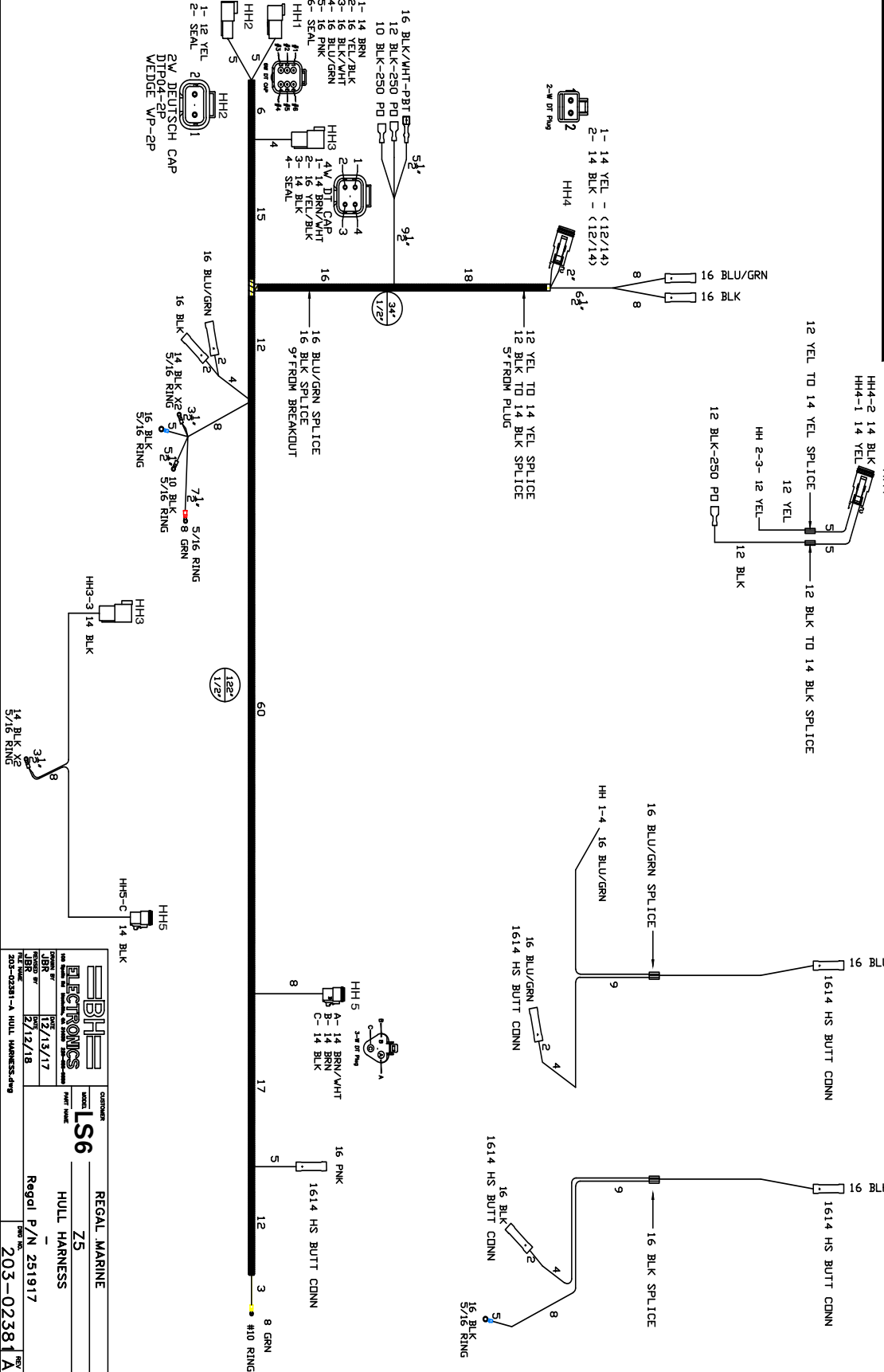

REV	DATE	DESCRIPTION	DATE	BY	CHK
1	12/13/17	CHANGED BLUE WIRE FROM AW TO A BY REWORKED TWO WIRES	12/13/17	JBR	JBR
2	2/12/18	DEL. 14 GRN WIRE, DEL. 12 BLU W. 12 GRN TO MATCH	2/12/18	JBR	JBR

**BENTON ELECTRONICS**  
 1000 JBR DR  
 JBR  
 2/12/18  
 203-02381-A HULL HARNESS.dwg

**LS6**  
 HULL HARNESS  
 Regal P/N 251917

**REGAL MARINE**  
 Z5  
 203-02381-A

# DECK HARNESS

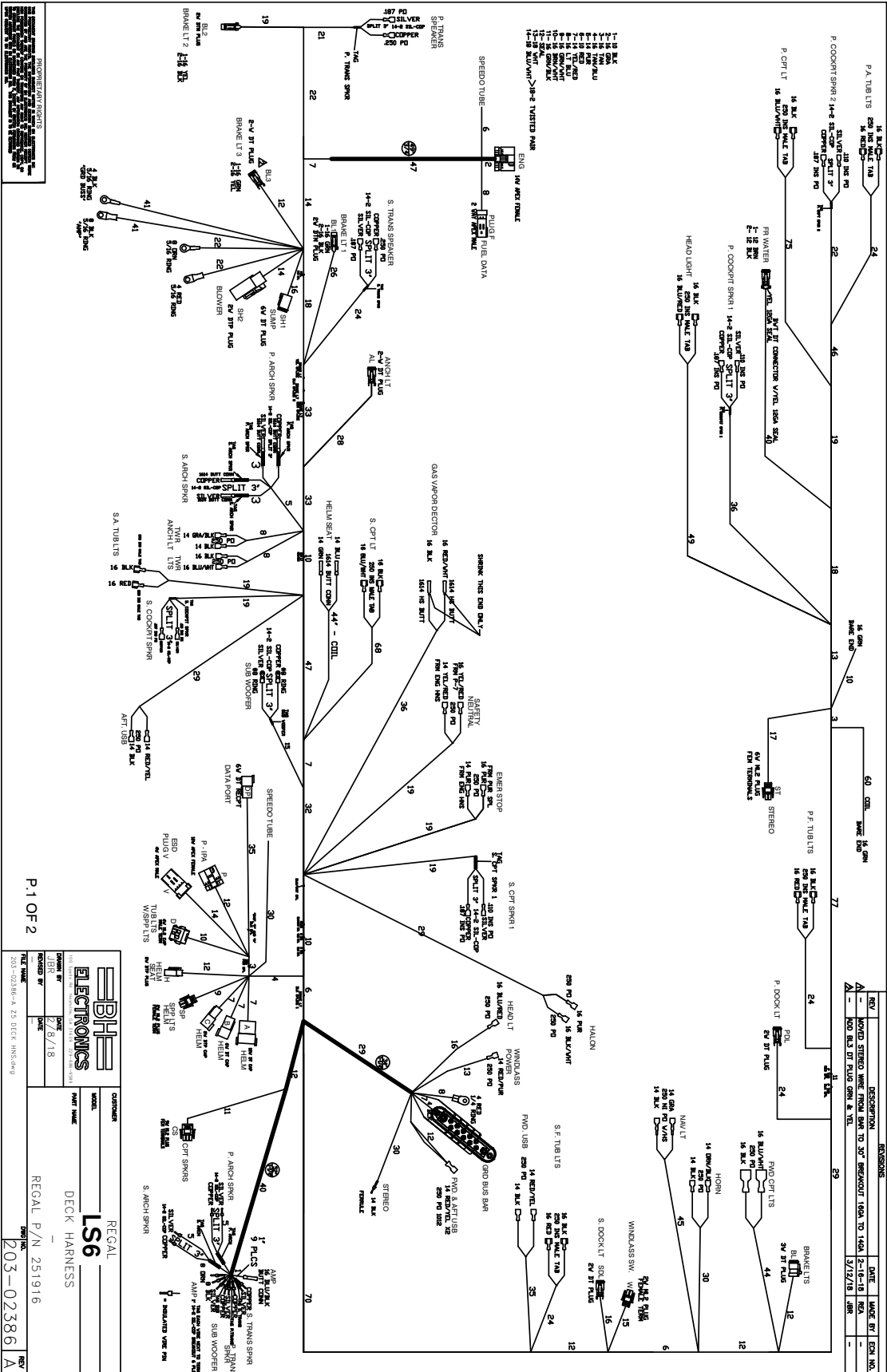

P.1 OF 2

		<b>REGAL</b> <b>LS6</b>	
CUSTOMER: REGAL MODEL: LS6 PART NAME: DECK HARNESS		REGAL P/N: 251916	
DESIGNED BY: [Name] DATE: 6/18	DRAWN BY: [Name] DATE: [Date]	CHECKED BY: [Name] DATE: [Date]	TELL NAME: [Name]
303-02386-A-23 DECK HNS-409		REGAL P/N: 251916	
303-02386-A		303-02386 A	

REV	DESCRIPTION	DATE	MADE BY	EQ. NO.
A	MOVED STEREO WIRE FROM BANK TO 30" BREAKOUT 100A TO 100B	2-16-18	NSM	-
A	ADD BUS OF FWD ORN & VEL	3/15/18	NSM	-



## LS SURF DUAL BATTERY SWITCH

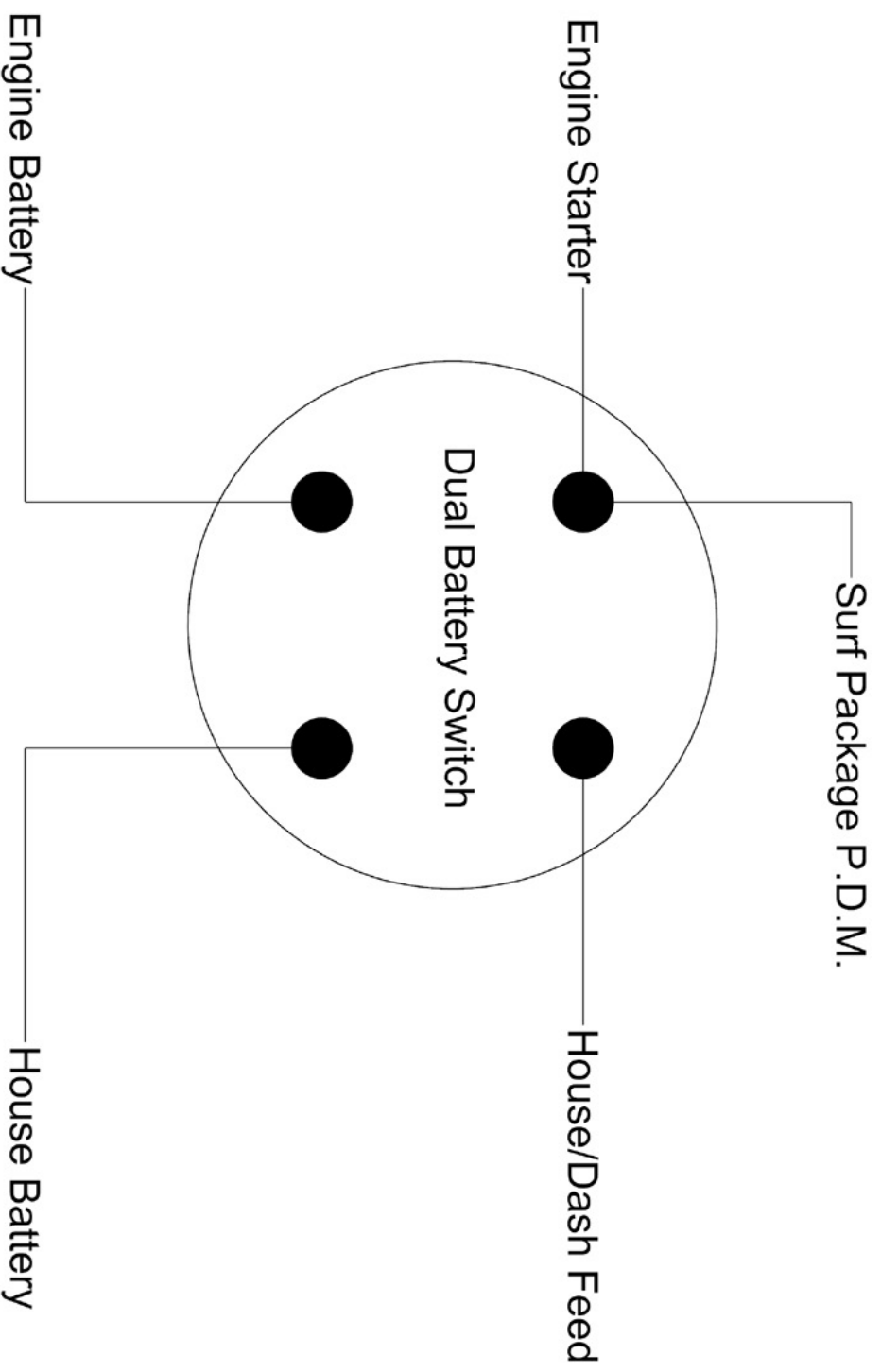

Note: Diagram specific to surf package with dual battery option. Additional connections may be required







# SWITCH PANEL WITH MAGNIFIED AFT VIEW

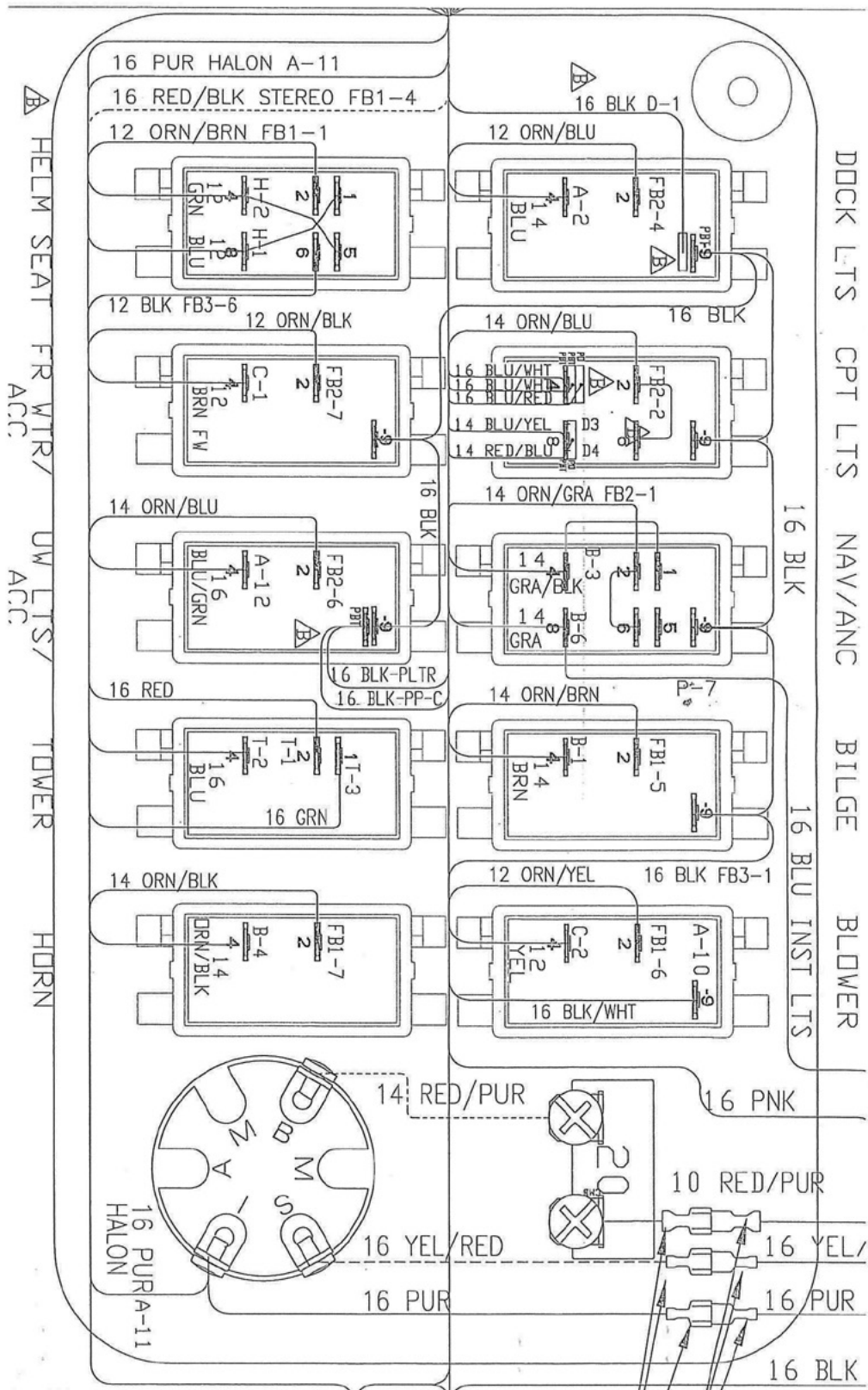

# LS-LX SERIES SPORTS TOWER ACTUATOR CONTROL BOX

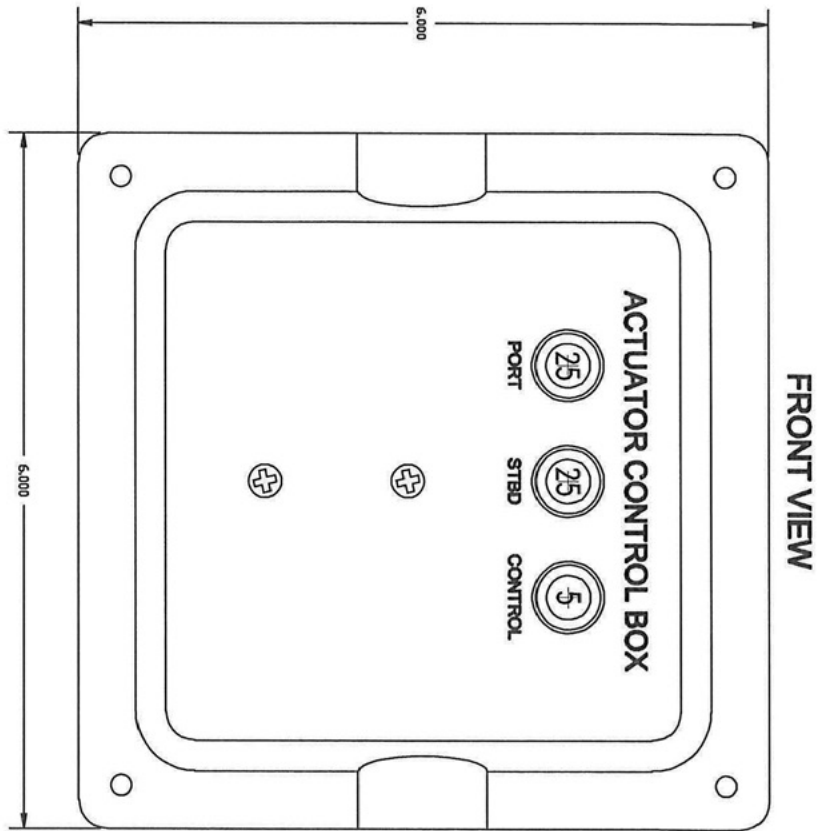

FRONT VIEW

**SHROUD**  
 P/N 740166026 REV. A QTY. 1 DESCRIPTION SCREENED BLK BOX (12-0166-080)

**ORDERING INFORMATION:**

KE P/N 85064286 DESCRIPTION ACT Ctlr BOX CUST P/N 985055

REGAL 2300 to 3350 ACTUATOR CONTROL BOX

**GENERAL INFORMATION:**

**CIRCUIT PROTECTION:**CARLING PUSH RESET SCREW TERM

P/N	QTY.	DESCRIPTION
042602005	1	5 AMP CKT BREAKER
042602025	2	25 AMP CKT BREAKER

**ACCESSORY ITEMS:**

P/N	QTY.	DESCRIPTION
080401007	2	#6 FLAT WASHER SS (RELAY)
080504003	2	#6-32 NYLOCK NUT (RELAY)
080802078	2	#6 X 1/2" BLK PPH SCREW
540503013	4	40A SEALED RELAY
080203012	4	RELAY MOUNTING CLIP
310102002	3	CB BLK BOOT
751000303	1	3 POS BUS BAR

**HARNNESS:**

P/N	REV.	QTY.	DESCRIPTION
900003476	B	1	PANEL WIRING

**NOTES:**

REV.	ECN#	DESCRIPTION	DATE	BY
A		RELEASED FOR PRODUCTION	01-21-13 MD	
B	R2494	PNL HRNS BUILD IMPROVEMENT	03-01-17MDM	

CREATED FROM 85064252



85064286  
 01-21-13 MD  
 SHEET 1 OF 1





# TYPICAL LS-LX SERIES STEREO PERFORMANCE PACKAGE

## LS Amplifier RCA Wiring/Settings

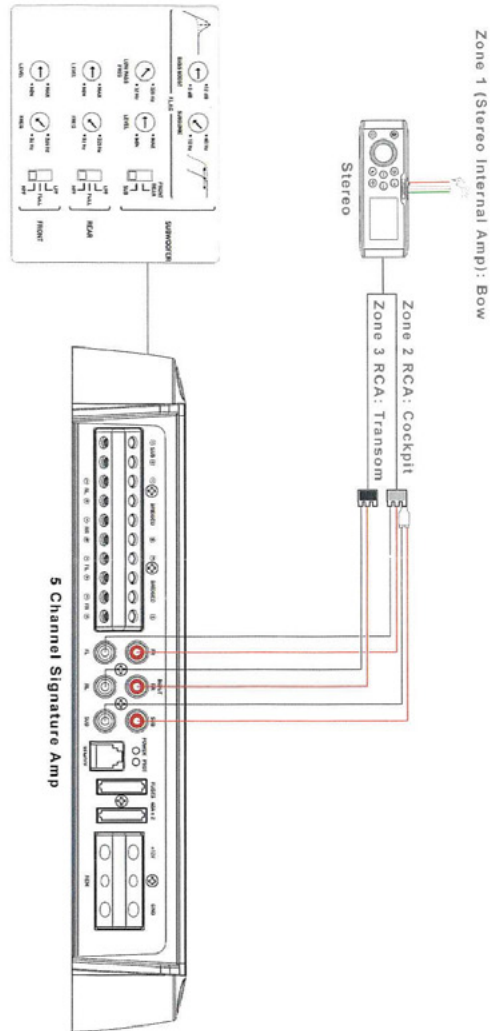

# TYPICAL LS-LX SERIES STEREO PERFORMANCE PACKAGE

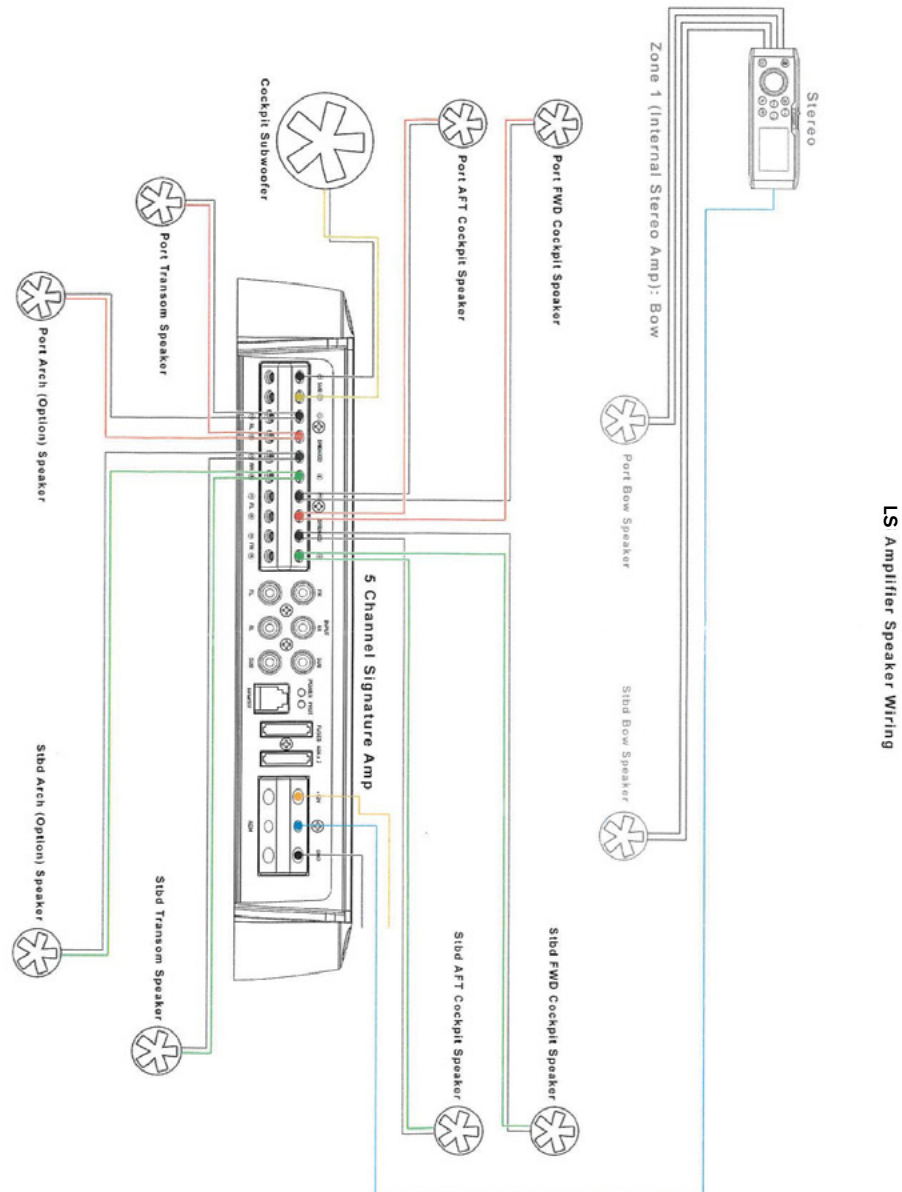

# HULL HARDWARE STARBOARD

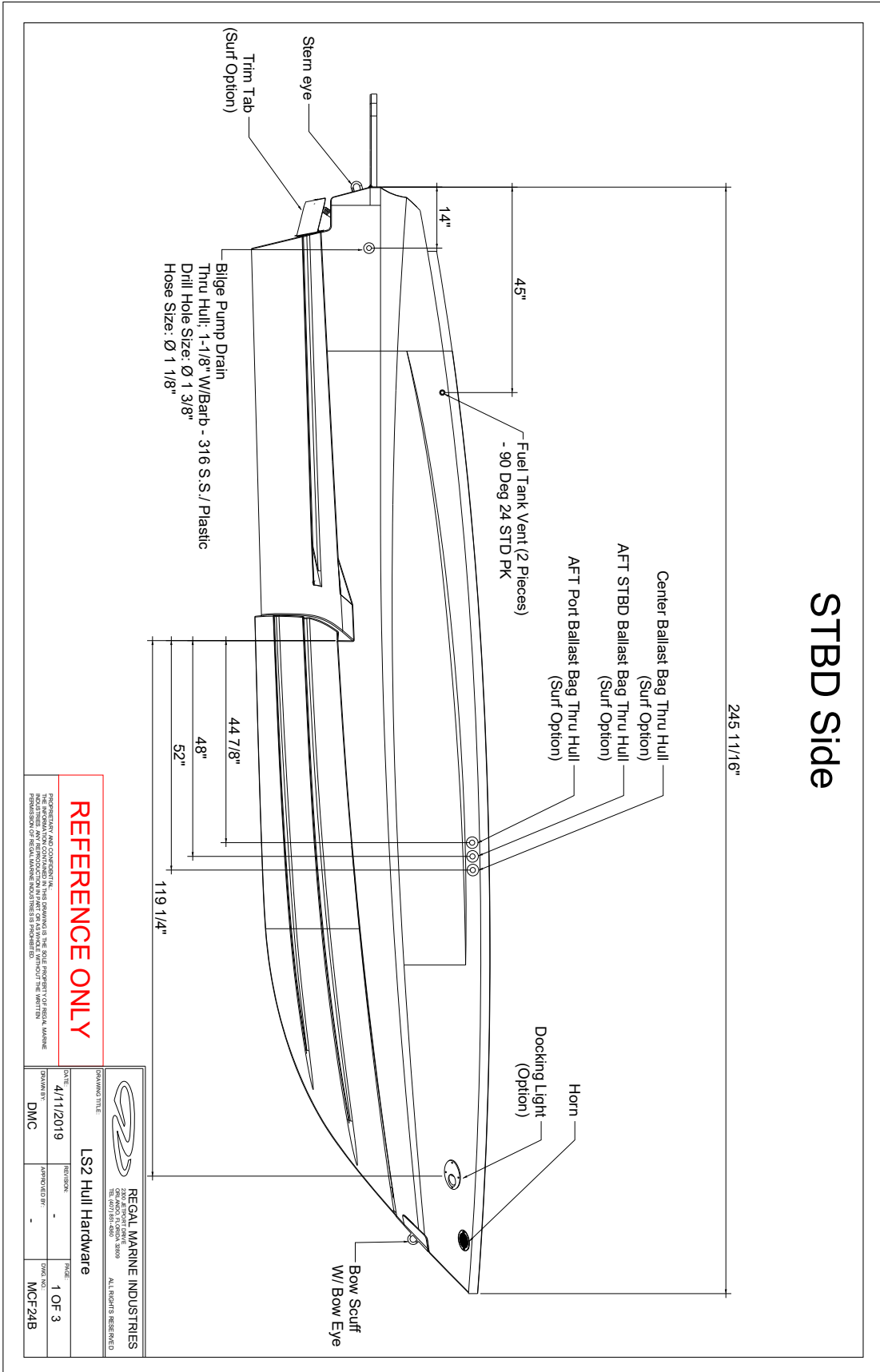

**REFERENCE ONLY**

PROPRIETARY AND CONFIDENTIAL. APPROVAL IS THE SOLE AUTHORITY FOR FINAL MARINE INSTALLATION AND REPRODUCTION IN ANY FORM OR MANNER WITHOUT THE WRITTEN PERMISSION OF REGAL MARINE INDUSTRIES IS PROHIBITED.

 <p><b>REGAL MARINE INDUSTRIES</b> ONE AUSTIN DRIVE, SUITE 200 MCKINNEY, TEXAS 75069 ALL RIGHTS RESERVED</p>		<p>DRAWING TITLE: <b>LS2 Hull Hardware</b></p>	
DATE: 4/11/2019	REVISION: -	APPROVED BY: -	TRUCK: 1 OF 3
DRAWN BY: DMC			TRUCK NO: MCF24B

# HULL HARDWARE PORT VIEW

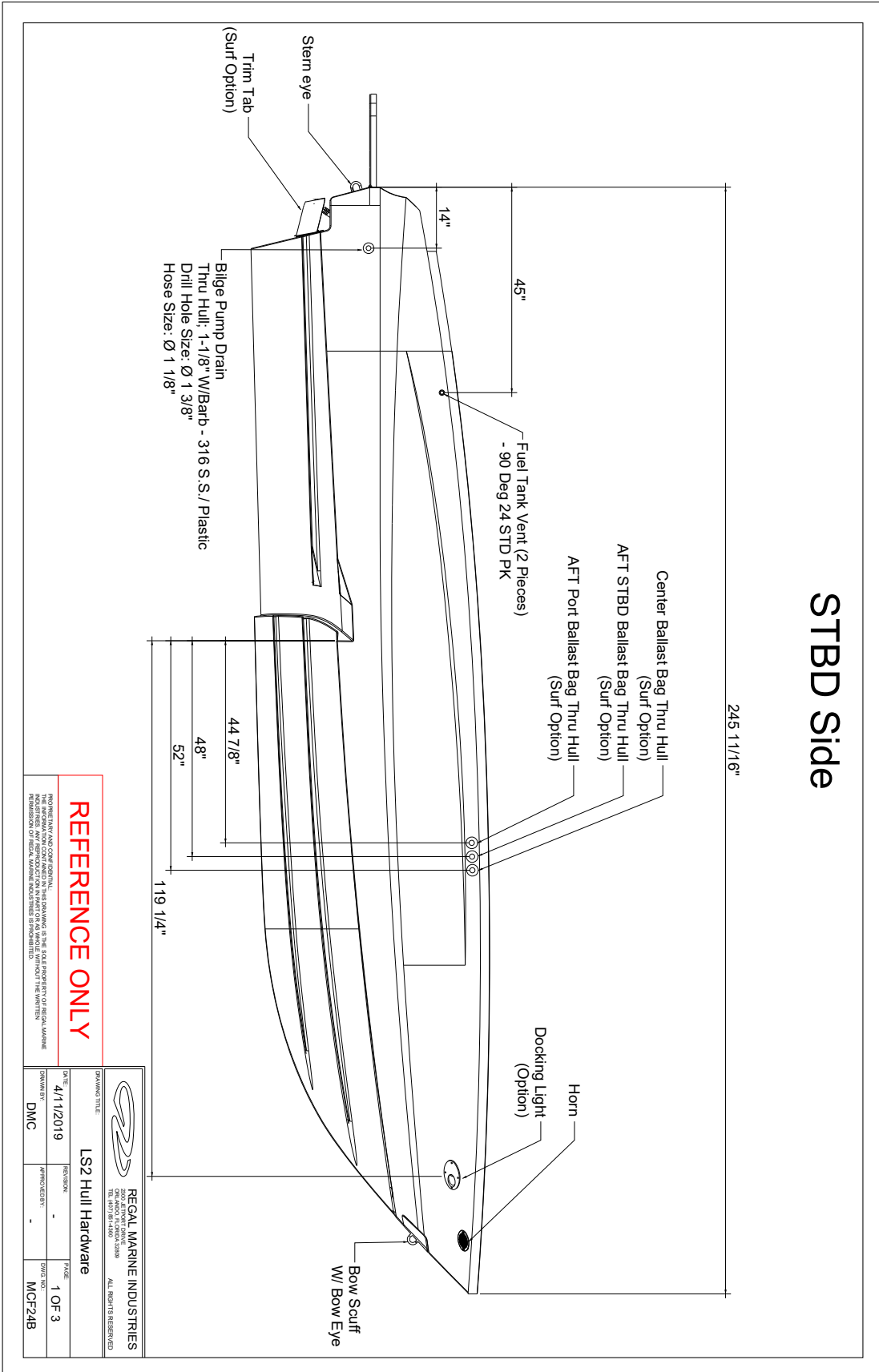

**REFERENCE ONLY**

REGAL MARINE INDUSTRIES AND CO. INC. IS NOT RESPONSIBLE FOR ANY DAMAGE TO YOUR VESSEL OR EQUIPMENT THAT MAY OCCUR AS A RESULT OF THE USE OF THIS DRAWING. THE INFORMATION CONTAINED HEREIN IS FOR INFORMATIONAL PURPOSES ONLY AND DOES NOT CONSTITUTE AN OFFER OF ANY PRODUCT. REGAL MARINE INDUSTRIES IS NOT RESPONSIBLE FOR ANY DAMAGE TO YOUR VESSEL OR EQUIPMENT THAT MAY OCCUR AS A RESULT OF THE USE OF THIS DRAWING.

 <b>REGAL MARINE INDUSTRIES</b> <small>2000 W. 10th Street, Suite 100          Fort Lauderdale, FL 33304          Tel: 954.343.8300</small>		<b>LS2 Hull Hardware</b> <small>ALL RIGHTS RESERVED</small>	
DATE	4/11/2019	REVISION	-
DRAWN BY	DMC	APPROVED BY	-
PAGE	1 OF 3	DATE	MCF24B



# HULL HARDWARE TRANSOM VIEW

## Transom

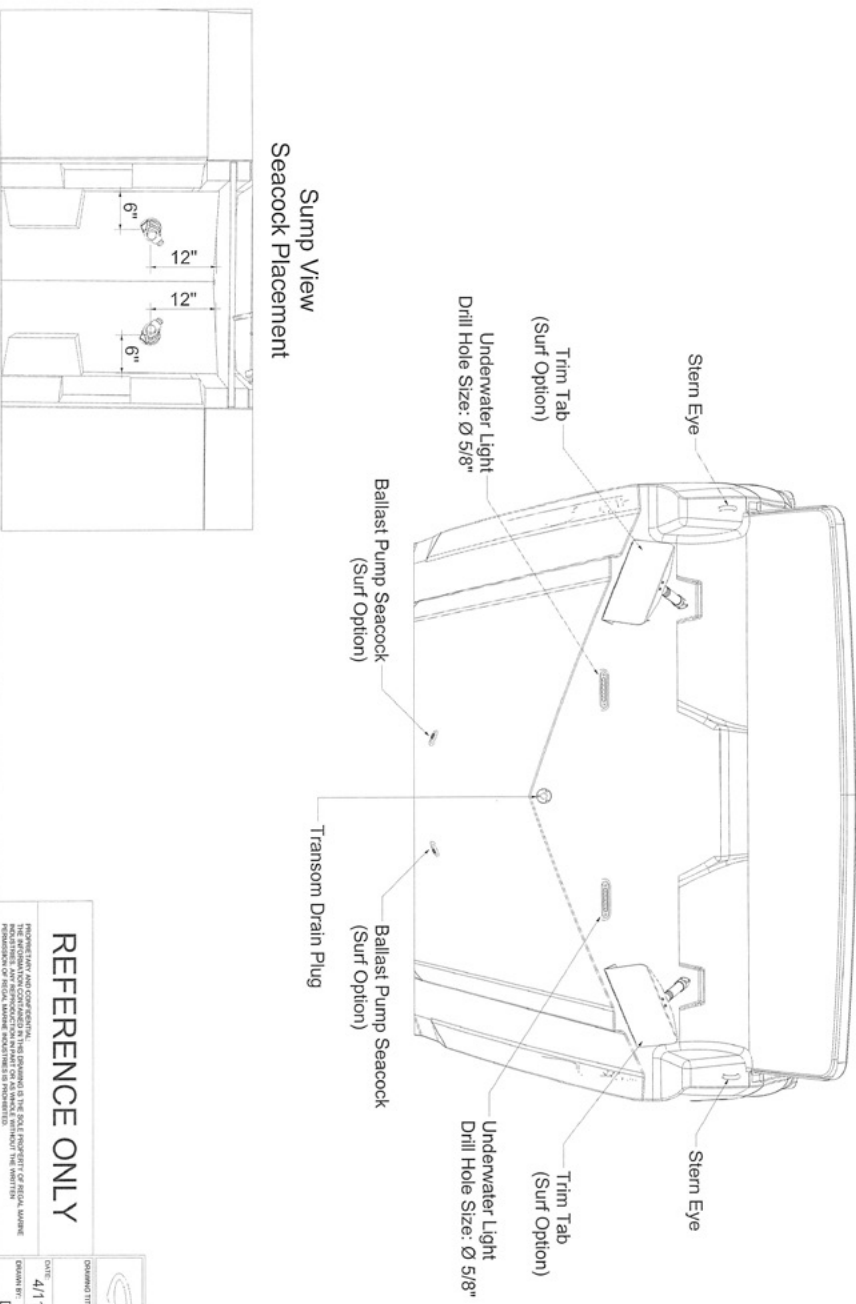

**REFERENCE ONLY**

REGAL MARINE INDUSTRIES, INC. MAKES NO WARRANTY, REPRESENTATION OR GUARANTEE, EXPRESS OR IMPLIED, AS TO THE ACCURACY, COMPLETENESS, OR QUALITY OF THE INFORMATION CONTAINED HEREIN. THE INFORMATION CONTAINED IN THIS DRAWING IS THE SOLE PROPERTY OF REGAL MARINE INDUSTRIES, INC. AND IS TO BE USED FOR THE PROJECT SPECIFICALLY IDENTIFIED IN THE DRAWING. ALL RIGHTS RESERVED.

 <p><b>REGAL MARINE INDUSTRIES</b> 2000 ADVANT DRIVE FELLSMITH, VA 22046-4200 ALL RIGHTS RESERVED</p>	
<p>DATE: 4/1/2019</p> <p>DRAWN BY: DMC</p>	<p>REVISION: -</p> <p>APPROVED BY: -</p>
<p>DRAWING TITLE: LS2 Hull Hardware</p>	<p>SCALE: 3 OF 3</p> <p>DWG. NO.: MCF24B</p>

# DECK HARDWARE TOP VIEW

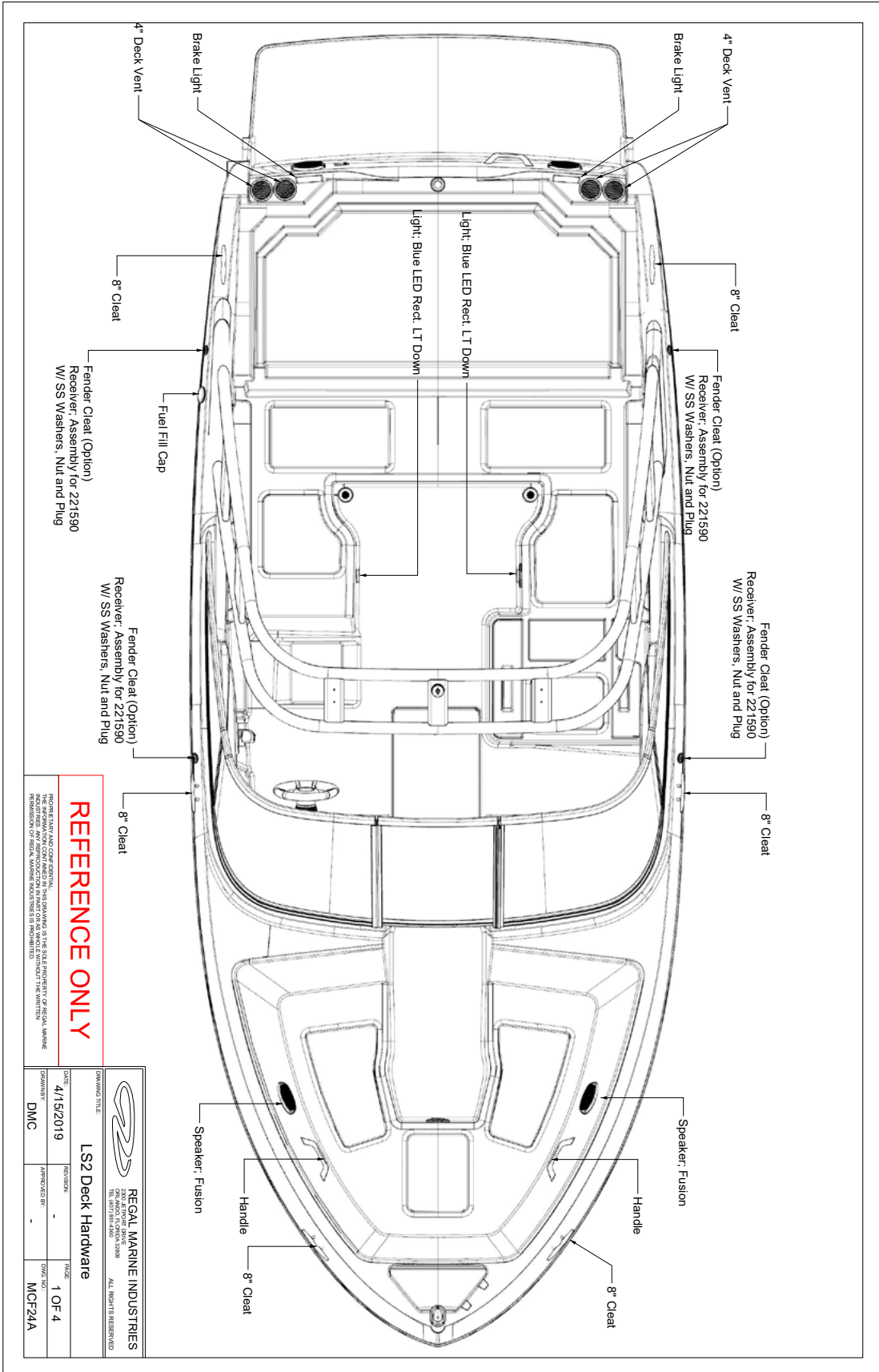

**REFERENCE ONLY**

REGAL MARINE AND COVE INCORPORATED, THE DESIGNING IS THE SOLE PROPERTY OF REGAL MARINE AND COVE INCORPORATED. ANY REPRODUCTION IN WHOLE OR IN PART WITHOUT THE WRITTEN PERMISSION OF REGAL MARINE AND COVE INCORPORATED IS PROHIBITED.

 <p>REGAL MARINE INDUSTRIES                  10000 W. BOULEVARD                  SUITE 1000                  BOCA RATON, FL 33433</p>		REGAL MARINE INDUSTRIES ALL RIGHTS RESERVED	
DATE	4/15/2019	REVISED	
DRAWN BY	DMC	APPROVED BY	
DRAWING TITLE <b>LS2 Deck Hardware</b>		PAGE	1 OF 4
		SYMBOL	MOF2AA

# DECK HARDWARE STARBOARD PROFILE

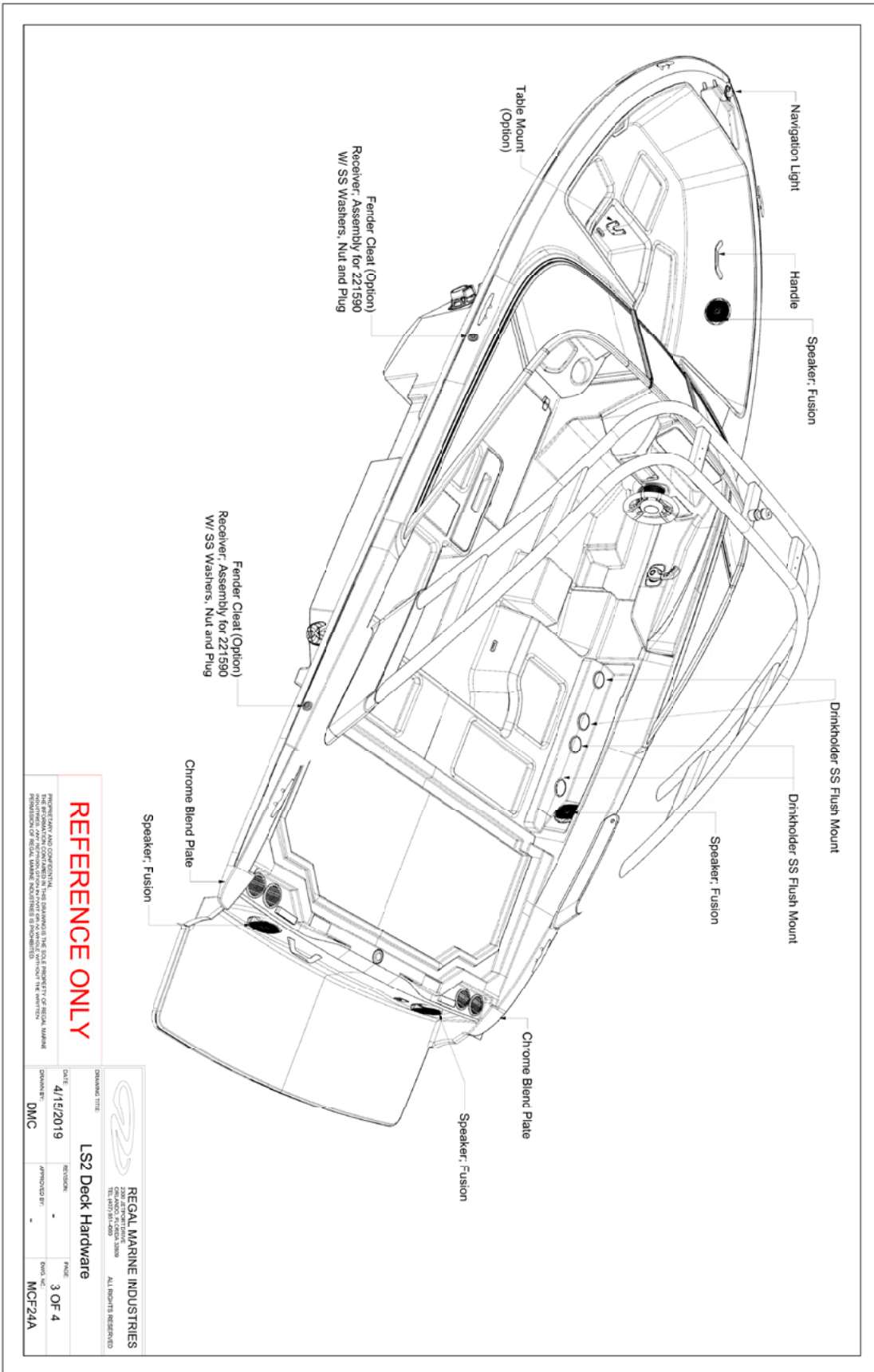

# DECK HARDWARE PORT PROFILE

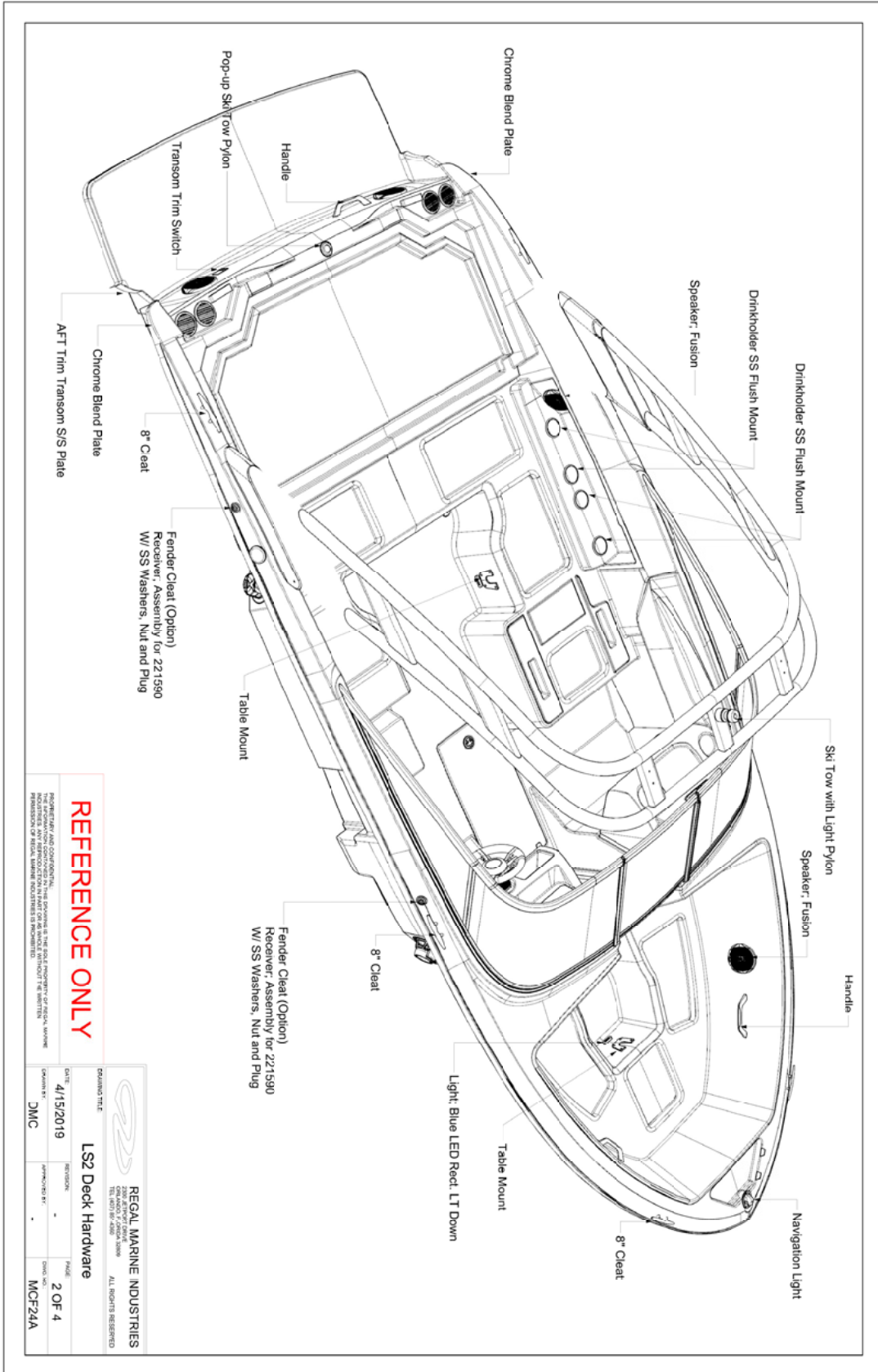

**REFERENCE ONLY**

REGAL MARINE INDUSTRIES  
 2200 EAST 15TH AVENUE  
 DENVER, CO 80202  
 TEL: (303) 751-6666  
 FAX: (303) 751-6667  
 WWW.REGALMARINE.COM  
 ALL RIGHTS RESERVED

 <p>REGAL MARINE INDUSTRIES                  2200 EAST 15TH AVENUE                  DENVER, CO 80202                  TEL: (303) 751-6666                  FAX: (303) 751-6667                  WWW.REGALMARINE.COM                  ALL RIGHTS RESERVED</p>	
DATE:	4/15/2019
DESIGNED BY:	CMC
APPROVED BY:	
PAGE:	2 OF 4
DWG. NO.:	MCF24A

# DECK HARDWARE AFT VIEW

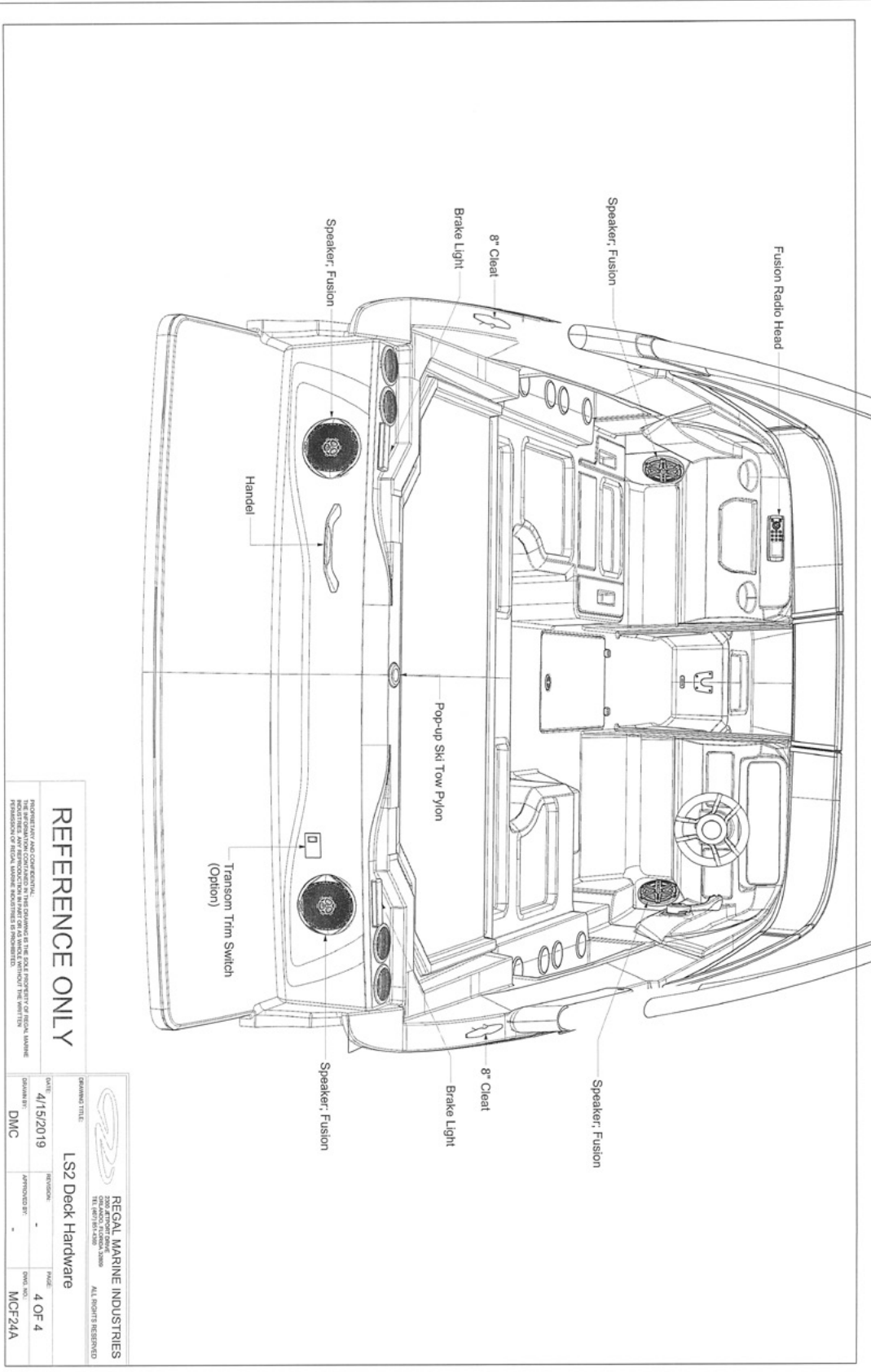

**REFERENCE ONLY**

PROHIBITIVE AND CONFIDENTIAL. THIS DRAWING AND CONTENTS ARE THE PROPERTY OF REGAL MARINE INDUSTRIES. ANY REPRODUCTION OR USE OF THIS DRAWING WITHOUT THE WRITTEN PERMISSION OF REGAL MARINE INDUSTRIES IS PROHIBITED.

 <p><b>REGAL MARINE INDUSTRIES</b>  <small>ONE MAIN STREET, SUITE 200          WESTPORT, MA 01886          TEL: 978.331.5200</small></p>		<p>REGAL MARINE INDUSTRIES  <small>ALL RIGHTS RESERVED</small></p>	
DATE:	4/15/2019	REVISION:	
DRAWN BY:	DMC	APPROVED BY:	
<p>LS2 Deck Hardware</p>		PAGE:	4 OF 4
		DMC NO.:	MCF24A



# TYPICAL LS SERIES FUEL TANK INSTALLATION

**Mounting Detail**

PVC Mounting Bracket #14 Screw 2" Long

Apply Caulking at screws

**BILL OF MATERIALS**

ITEM	QTY.	DESCRIPTION
1	2	70 1/2" Long Neoprene Tape
2	8	9 1/2" Neoprene Tape
3	-	-
4	4	6" x 1" PVC (1/2" Thick)
5	12	#14 Panhead Screws 2 inch Long

**70 1/2" Neoprene Tape Detail**

9 1/2" Neoprene Tape Detail

REGAL MARINE INDUSTRIES  
 2000 W. 10th Street, Suite 100  
 Ft. Lauderdale, FL 33304  
 Tel: 954.333.3333 Fax: 954.333.3333  
 www.RegalMarine.com

REGAL MARINE INDUSTRIES  
 ALL RIGHTS RESERVED

DATE: 3/27/2019  
 DRAWN BY: DMC  
 APPROVED BY: Spencer M.  
 TITLE: LS2 (CF) Fuel Tank Installation  
 1 OF 3  
 MCF23C

REGAL MARINE AND COMPANY, INC. IS PROVIDING THIS SET OF DRAWINGS OF REGAL MARINE INDUSTRIES' PROPERTY. THE USER AGREES TO HOLD REGAL MARINE INDUSTRIES HARMLESS AND TO INDEMNIFY REGAL MARINE INDUSTRIES FROM AND AGAINST ALL SUCH DAMAGES, LOSSES AND EXPENSES, INCLUDING REASONABLE ATTORNEY'S FEES, THAT MAY BE INCURRED BY REGAL MARINE INDUSTRIES AS A RESULT OF THE USER'S USE OF THESE DRAWINGS.

# TYPICAL LX OUTBOARD FUEL TANK INSTALLATION

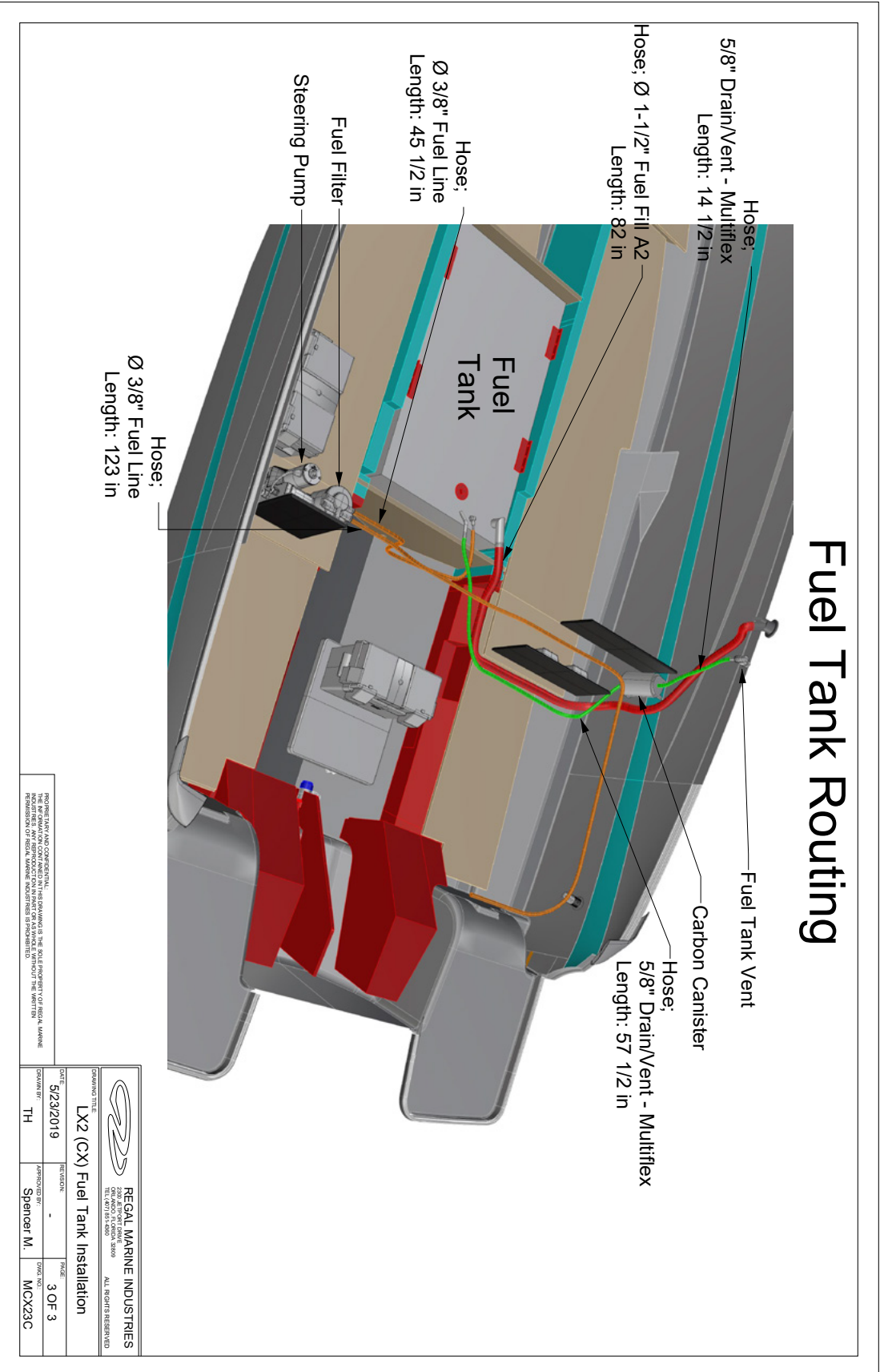

REGAL MARINE INDUSTRIES  
 10000 W. BAYVIEW BLVD., SUITE 100  
 BAYVIEW, MI 48064-1500  
 TEL: (588) 333-3333 FAX: (588) 333-3333  
 WWW.REGALMARINE.COM

 <b>REGAL MARINE INDUSTRIES</b> 10000 W. BAYVIEW BLVD., SUITE 100 BAYVIEW, MI 48064-1500 TEL: (588) 333-3333 FAX: (588) 333-3333 WWW.REGALMARINE.COM	
DRAWING TITLE <b>LX2 (CX) Fuel Tank Installation</b>	
DATE 5/23/2019	REVISIONS -
DRAWN BY TH	APPROVED BY Spencer M.
PAGE 3 OF 3	DWG NO. MCX23C

# TYPICAL LS SERIES COCKPIT DRAIN SYSTEM 1

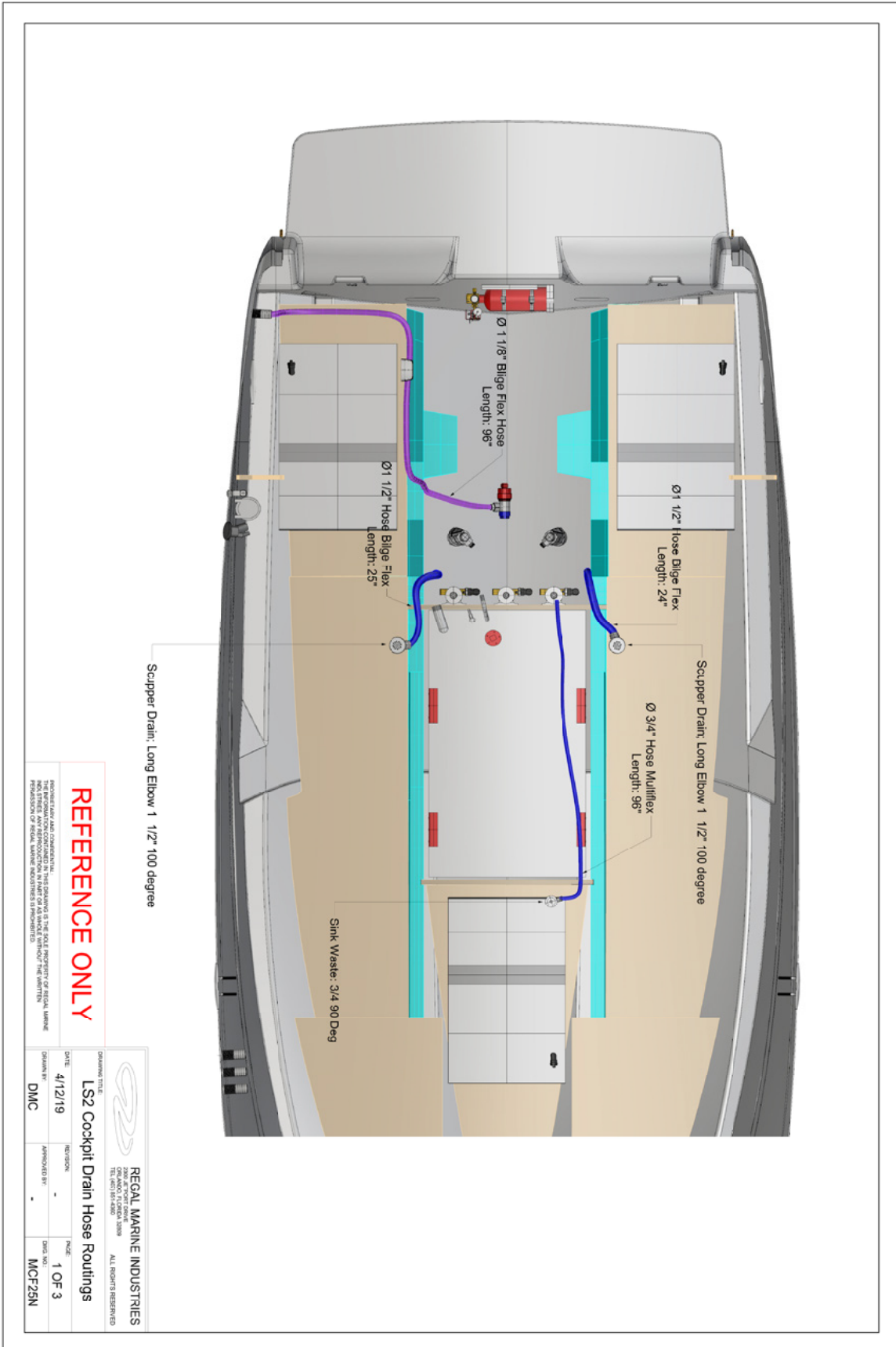

# TYPICAL LS SERIES COCKPIT DRAIN SYSTEM 2

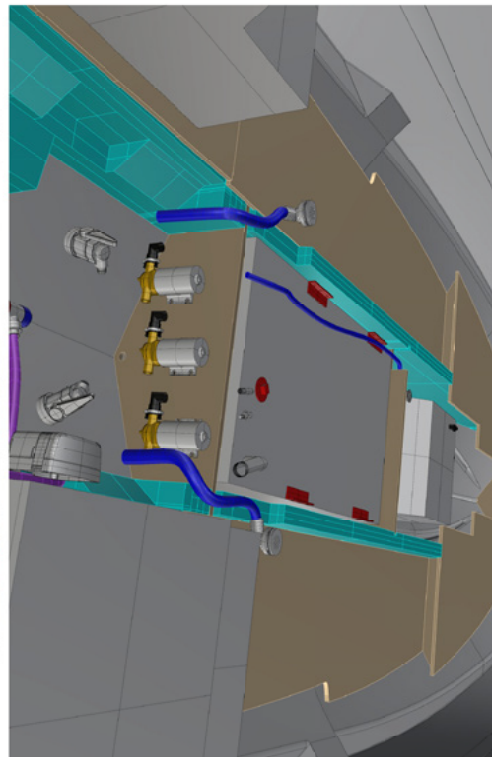
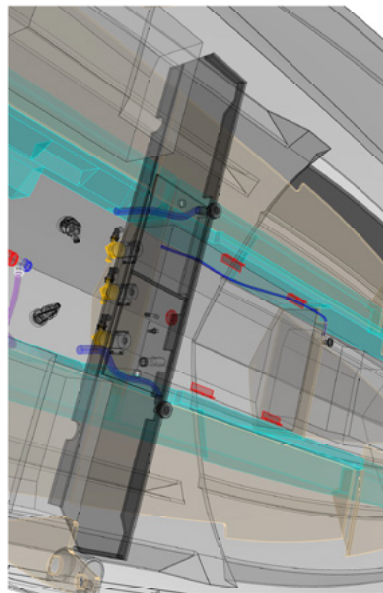
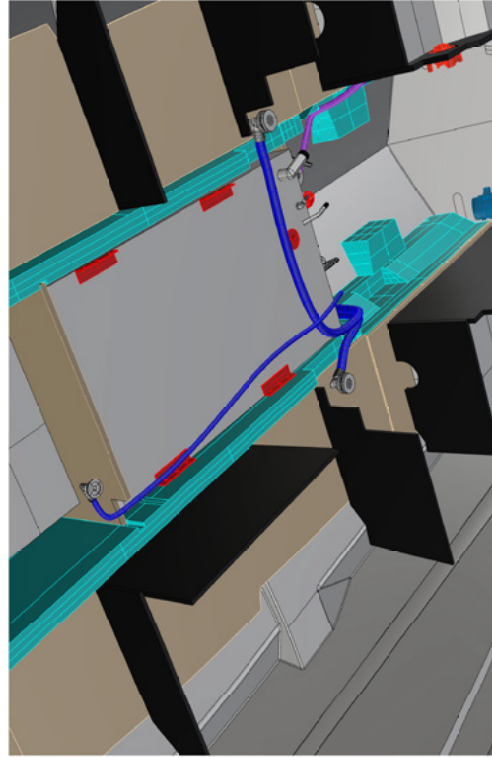
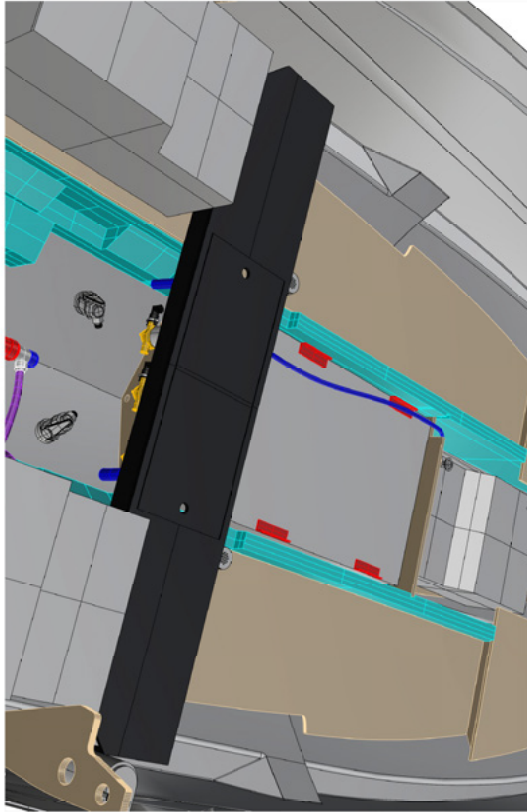

**REFERENCE ONLY**

REGAL MARINE INDUSTRIES  
 10000 16th Avenue S.E.  
 Bellevue, WA 98006  
 TEL: (206) 835-4400  
 WWW.REGALMARINE.COM

 <b>REGAL MARINE INDUSTRIES</b> 10000 16th Avenue S.E. Bellevue, WA 98006 TEL: (206) 835-4400 WWW.REGALMARINE.COM ALL RIGHTS RESERVED			
DATE:	4/12/19	DESIGNER BY:	DMC
APPROVED BY:		DATE:	2 OF 3
		DRW. NO.:	MCF25N

# TYPICAL LS SERIES COCKPIT BILGE PUMP DRAIN SYSTEM

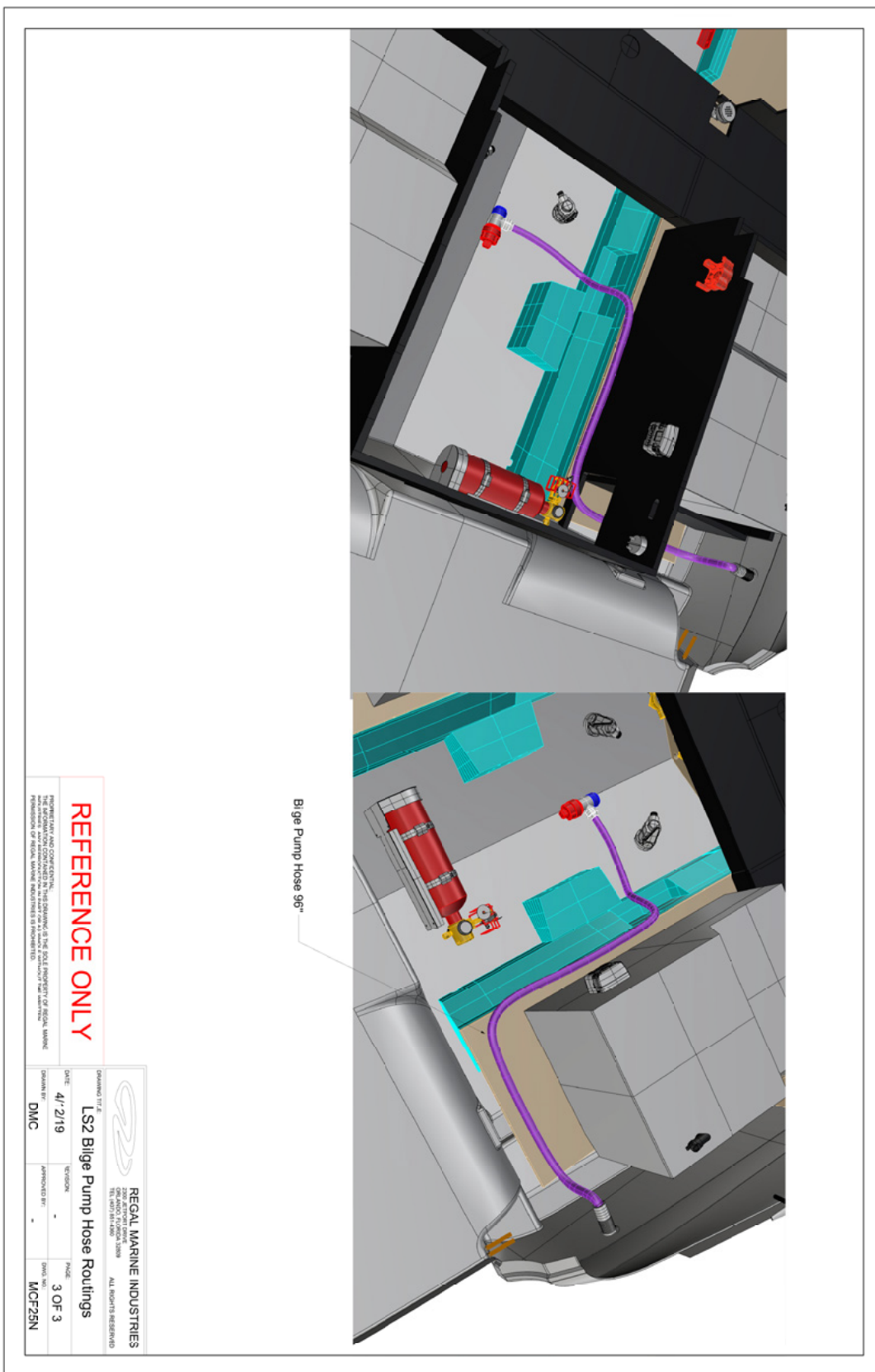



# TYPICAL LX2 OUTBOARD COCKPIT BILGE PUMP DRAIN SYSTEM

