



REGAL 33 SAV OWNER'S MANUAL

 REGAL

MARCH 2018 EDITION

Notes

FUEL SYSTEMS

Boats manufactured for use in California for model year 2018 and after meet the California EVAP Emissions regulation for spark-ignition marine watercraft. Boats meeting this requirement will have a label affixed near the helm.

WARNING

Operating, servicing and maintaining a recreational marine vessel can expose you to chemicals including engine exhaust, carbon monoxide, phthalates, and lead, which are known to the State of California to cause cancer and birth defects or other reproductive harm. To minimize exposure, avoid breathing exhaust, service your vessel in a well-ventilated area and wear gloves or wash your hands frequently when servicing this vessel. For more information go to: www.P65warnings.ca.gov/marine.

The fuel system in this boat complies with U.S. EPA mandated evaporative emission standards at time of manufacture using certified components.

MANUFACTURER'S WARRANTY COVERAGE

This evaporative emission control system is warranted for two years. If any evaporative emission-related part on your spark-ignition marine watercraft is defective, the part will be repaired by Regal Marine Industries, Inc.

OWNER'S MANUAL RESPONSIBILITIES

- As the spark-ignition marine watercraft owner, you are responsible for the performance of the required maintenance listed in your owner's manual. Regal Marine Industries, Inc. recommends that you retain all receipts covering maintenance on your spark-ignition marine watercraft, but Regal Marine Industries, Inc. cannot deny warranty solely on the lack of receipts.
- As the owner, you should be aware that Regal Marine Industries, Inc. may deny you warranty coverage of your spark-ignition marine watercraft or a part has failed due to abuse, neglect, or improper maintenance or unapproved modifications.
- You are responsible for presenting your spark-ignition marine watercraft to a Regal Marine Industries, Inc. distribution center or a service center as soon as the problem exists. The warranty repairs should be completed in a reasonable amount of time, not to exceed 30 days. If you have any questions regarding your warranty coverage, you should contact Regal Marine Industries, Inc. at 407-851-4360.

Introduction

Boating is becoming more popular each and every year. There are numerous types of recreational vessels on our waterways today involved in an every growing number of activities. Therefore, as a Regal boat owner it is of the highest priority to learn about general boating practices before operating your vessel.

Your Regal dealer will answer many questions and provide valuable “hands on” information during the completion of the new boat delivery process. In addition, your dealer has received special factory training on the product line and his services should be employed to solve any technical problems and periodic maintenance beyond the scope of this manual. Your Regal dealer carries a line of factory approved parts and accessories.

Your Regal dealer can provide information regarding national training organizations such as the U.S. Power Squadron and United States Coast Guard Auxiliary. Along with other organizations and literature, they can help build your “boating savvy” by developing the necessary skills and awareness to be a safe and confident skipper.

Also, your local library can assist in providing recommended boating literature such as Chapman Piloting Seamanship & Boat Handling by Elbert S. Maloney. Also, boating information is available on the internet.

Remember, waterway conditions can change in a heartbeat. Knowing how to react quickly comes from experience and knowledge which can be gained through boating education.

Welcome aboard!

Welcome to Regal

I know I speak for everyone at Regal when I welcome you to the ever-growing family of Regal boat owners. You've chosen a boat that is recognized worldwide for its standard of excellence. Each step in construction has been carefully scrutinized to assure safety, performance, reliability and comfort for both your passengers and yourself.

Your yacht is certified by the National Marine Manufacturers Association. It also complies with the applicable standards set by the United States Coast Guard , American Boat and Yacht Council and the International Marine Certification Institute. Your Regal boat was built with the same attention to detail and quality of construction that we would expect in a craft we would purchase ourselves.

Whether you're a veteran boater or a newcomer, we strongly urge you to read this owner's manual thoroughly. Familiarize yourself with the various components of your vessel, and heed the safety precautions noted herein.

If you have questions that are not covered in this manual, please consult your authorized Regal dealer for assistance, phone the Regal factory at 407-851-4360 or E-mail us at www.regalboats.com.

Thank you, and welcome to the "World of Regal !"

Duane Kuck
President & CEO

Our Mission

With God's Help and a Steadfast Commitment to Integrity, We will Develop a Team of Exceptional People and Relationships to Provide Exceptional Customer Satisfaction.

Table Of Contents

2	Notes
3	Introduction
4	Welcome to Regal
6	Chapter 1 - General Vessel Information
18	Chapter 2 - Safety On Board
41	Chapter 3 - Rules Of The Road
51	Chapter 4 - Systems
116	Chapter 5 - Outboard Engines & Controls
135	Chapter 6 - Vessel Operation
149	Chapter 7 - Auxiliary Equipment Operation
173	Chapter 8 - Care & Maintenance
191	Chapter 9 - Troubleshooting
198	Chapter 10 - Storage & Winterization
203	Chapter 11- Glossary & Index
209	Chapter 12 - Technical

Chapter 1

General Vessel Information

Regal Owner's Manual

Your Regal owner's manual has been compiled with information to assist you in operating your craft with safety and pleasure. This manual targets specific details of Regal related systems and components along with their location, operation and maintenance that normally are not found in the vendor information. In addition, supplier related equipment information is located within the owner's information packet.

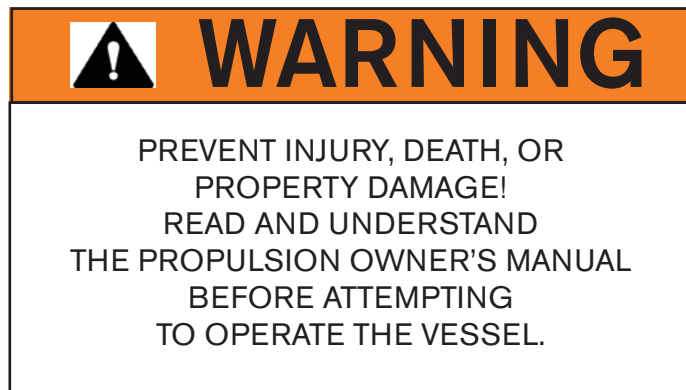

The Regal owner's manual is not to be thought of as a complete shop technical document. Besides the system chapters, there is troubleshooting information devoted to select current standard and optional equipment. In addition, refer to the engine and generator (if installed) operator's manuals. More detailed information may exist in the owner's packet associated with that component.

Remember that your Regal dealer has received special factory training and his services should be employed to solve more technical problems. Call

407-851-4360 or go to the internet at regalboats.com to find the closest Regal dealership.

In keeping with its commitment to improvement Regal Marine Industries, Inc. is continually upgrading the product line. Regal notes that all dimensions, specifications, models, standard and optional equipment is subject to change without notice at any time.

Regal Owner's Manual



Currently there is a QR label attached to a visible location such as the helm or cabin. This label when scanned by an I phone will take you via an app to the Regal web-site where you can download

your models owner's manual or for that matter any Regal owner's manual.

With the manual downloaded you can duplicate it into a format you are comfortable using. The QR label is used globally for any type product from the food, home and auto business to boats. It affords much more capacity and is much more customer friendly than the traditional bar code used by manufacturer's on their products. *Other Regal owner's manuals can be found by scanning this QR Code or by going to: regalboats.com/owners*

Owner's Information Packet



An owner's information packet (black satchel) is located on the vessel. Read and become familiar with the materials.

This packet contains valuable information on your propulsion package, standard and optional equipment, systems, care and maintenance along with component warranty. Store the information packet in a clean, dry location on board your vessel.

Vessel Information Sheet

It is recommended that you fill out the information on the following page. It will supply vital statistics on your vessel. Make a copy of the data for safe keeping at home.

ABYC Yacht Plate

In proximity to the helm on Regal boats over 26' in length is a NMMA (National Marine Manufacturer's Association) yacht plate. This plate recognizes that your vessel was built to ABYC design compliance standards in effect on the date the certification was verified. The plate also states that your vessel complies with United States Coast Guard safety system standards in effect on the date of certification.

Note: Overloading, improper loading and weight distribution are well documented causes of accidents. Provide for an extra margin of safety in rough sea conditions.

Hull Identification Number

The United States Coast Guard has established a universal system of numerically recognizing vessels by using a hull identification number or "HIN." This number identifies your Regal yachts' model, hull number, month and year of manufacture. The HIN



is normally found on your boat's transom, on the starboard side, just below the rub rail on the tran-

som vertical surface. The HIN is stamped on a plate and reinforced with a special adhesive. The HIN consists of 12 alpha or numeric characters.

It is recommended that you locate and write down the HIN for future reference. It can be especially useful when ordering parts from your Regal dealer. A second HIN number is found in a hidden location. This second HIN is useful to authorities if the vessel is stolen and/or the original transom HIN is modified or eliminated.

Vessel Float Plan

Formulate the float plan on the following page before departing. Leave it with a responsible person who will notify the United States Coast Guard or local law enforcement authorities if you do not return as planned. If you change your plans be sure to notify this person. Make copies of the float plan and use one each time you go boating. This will help people know where to find you should you not return on schedule. Do not file the float plan with the United States Coast Guard.

Vessel Information Sheet

Owner: _____

Address: _____

City & State: _____

Home Phone: _____ Business Phone: _____

In Case Of Emergency Notify: _____

Address _____

City & State _____

Phone _____

Insurance Agent's Name: _____

Policy#: _____

USCG Phone: _____ Local Police: _____

Marina Phone: _____ Slip (Dock#): _____

Hull Serial #: RGM _____

Key #: _____ Engine: _____

Selling Dealer: _____

Address: _____

City & State: _____

Phone: _____ Fax: _____

Servicing Dealer: _____

Address: _____

City & State: _____

Phone: _____ Fax: _____

Vessel Float Plan

Fill out this form before departure. Leave it with a responsible person who will notify the Coast Guard or police if you don't return as planned. If you change your plans be sure to notify this person. Make copies of the float plan and use one each time you go on a trip. This will help people know where to find you should you not return on schedule. Do not file this plan with the Coast Guard.

Owner: _____
 Address: _____
 City & State: _____
 Telephone#: _____

Person Filing Report: _____
 Name _____
 Telephone _____

Make Of Craft: _____
 Length _____ Boat Name _____
 Color _____ Trim _____ Hp _____
 Inboard _____ Stern Drive _____
 Hull I.D.# _____
 Documented Vessel # _____

Other Information _____

Safety Equipment Aboard: _____
 Life Jackets _____
 First Aid Kit _____
 Flares _____
 Flash Light _____
 VHF Radio _____
 Cell Phone __# _____
 Computer __Desk Top ____Lap Top____
 E-mail address _____
 Food _____Water _____

State Registration# _____
 Destination: _____
 Leave From _____
 Time Left _____
 Going To _____
 Fuel Capacity _____
 Est. Day Of Arrival _____

 Est. Time Of Arrival _____
 If Not Back By _____ o'clock Call Authorities

Persons Aboard:

Name	Age	Address	Phone
_____	_____	_____	_____
_____	_____	_____	_____
_____	_____	_____	_____
_____	_____	_____	_____
_____	_____	_____	_____

____ See Other Side For Additional Persons

Vessel Cruise Checklist

- Obtain a current weather update.
- Hoist the boat & periodically inspect the hull bottom and propellers for damage. Marine growth such as barnacles will affect performance and fuel efficiency. Check sacrificial anodes located on the propulsion unit, transom and engine. Replace anode if less than 2/3 remaining.
- Check the electrical system and all safety related equipment. Carry extra fuses. Ensure they are of the proper capacity and type.
- If your boat has been in the water, run the bilge pump until the flow of water stops.
- Check to see that all bilge water has drained and the drain plug is installed before launching If your boat if it has been out of the water.
- Check that all required safety equipment is on board and in good working condition Examples include personal flotation devices (PFD's), horn, bell, hand held fire extinguishers, and visual distress signals.
- Check fuel level. Fuel tanks should be filled to slightly less than capacity. Allow for fuel expansion. Remember the "one third rule".
- Open engine compartment. Inspect for fuel odors and visible leaks in the fuel, oil, coolant, exhaust and power steering systems.
- Check all fuel filters for the presence of water.
- Check fluid levels of engines, drives and generator (if applicable).
- Inspect engine for cracked hoses, worn or loose belts, and loose hardware.

Recommended On Board Equipment

Tools:

Allen Wrenches
Jack Knife
Phillips Screwdriver
Regular & Needle Nose Pliers
Combination Box & End Wrench Set
Screwdriver Set (One With Various Tips)
Side Cutters
Ratchet & Socket Set
Electrical Crimper,Cutter,Stripper Combo
Hammer
VOA Electrical Tester
Water Pump Pliers
Vise Grip Pliers
Floating Flashlight/Lantern
Oil/Fuel Filter Wrench
Tape Rule

Basic Gear & Supplies:

Tow Line
Lubricating Oil, Liquid Wrench
Mooring Lines
Duct & Electricians Tape
Dock Fenders
Coolant (Engine Freshwater Side)
Distress Signals
Engine, Drive, Power Steering Oil
First Aid Kit
Boat Soap (Not Dish Soap)
Boat Hook
Woody Wax
Charts & Plotting Instruments
Back-up
Vinyl Cleaner
Emergency Food & Water
Hydrogen Peroxide (AC Pans)
EPIRB

Spare Parts:

Fuel Filters-Engines & Generator
Poly V- Belt (See Engine Manual)
Coolant For Engine Freshwater System
Extra Light Bulbs
Seawater Filter
Fuses
Propeller Set (See Dealer)
Propeller Hardware
Flashlight Batteries
Engine Spare Parts
Generator Spare Parts
Air Filters-Engine & Generator
Oil Filters-Engine, Generator
Drive Oil Filters

Life Raft
Bailer or Hand Pump
Rust Stain Remover (Star Brite)
Extra Hand Held Fire Extinguishers
Corrosion Block
Personal Floation Devices
Bilge Cleaner
Clean Rags, Diapers
(For Under Engine-Oil Leaks)
Nylon Windbreaker Suit
Sunscreen (SPF 30+)
Shop Vacuum (1 Gal. Cap. Wet-Dry)
Bucket/Pans w/Lids-Draining/Storing
Used Fluids
Squeegee
Mirror (For Inspection & Emergency Signaling)
Binoculars

Owner's Registration & Systems

Please note that your boat requires the proper registration by your authorized Regal dealer. To initiate the vessel warranty your dealer must complete the owner's registration form and systems checklist at the time of delivery. The owner must sign the paperwork to acknowledge that the dealer has reviewed the boat systems and warranty provisions with the owner. The owner should keep the original paperwork that features a temporary warranty registration. A warranty certificate will be sent approximately 6 weeks after receipt of the paperwork at Regal World Headquarters.

Dealer's Responsibility

Your vessel has undergone rigid quality assurance inspections before leaving the factory. In addition, your dealer has been trained to perform final pre-delivery checks and to service your Regal boat.

Your dealer's responsibilities include:

1. An orientation in the operation of your Regal boat including matters relating to the safe operation of the vessel.
2. Completion and mailing of your boat registration warranty form to Regal.
3. Location of vendor warranties, registration materials, owner's manual, operation, installation and maintenance instructions for auxiliary equipment supplied with or installed on your Regal boat.

Owner's Responsibility

You are entitled to all the benefits and services outlined in your Regal warranty. However, you have certain responsibilities to ensure warranty satisfaction. These are:

To read the warranty materials and understand them fully.

To examine the vessel in detail at the time of delivery.

To apply the following: boating rules and regulations, safety equipment, environmental regulations, accident reports and warranty regulations terms and conditions.

To read thoroughly all literature supplied with your boat including this owner's manual and to follow the recommendations in the literature.

To provide proper maintenance and periodic servicing of your boat and equipment as set forth in the various manuals supplied.

Customer Service

Take the time to write down your Regal dealer's phone number and E-mail address for future reference. Along with your Regal dealer information is a listing below of other phone numbers and web addresses which may prove useful.

Regal Dealer:

Phone: _____

E-mail: _____

Regal Marine Customer Service:

1-800-US REGAL (1-800-877-3425)

regal@regalboats.com

customer.service@regalboats.com

REGAL MARINE INDUSTRIES, INC. LIMITED WARRANTY

Welcome to the Worldwide Family of Regal Owners! We are very pleased that you have chosen a Regal Powerboat!

This document is your Limited Warranty Registration Certificate and Statement of Limited Warranty. Please check the registration information section for accuracy. If this information is not correct or if you change your address at some future date, please notify us at the following address: Regal Marine Industries, Inc. Attention: Warranty Registrations, 2300 Jetport Drive, Orlando, Florida 32809; or e-mail customerservice@regalboats.com.

Please read the warranty carefully. It contains important information on Regal's claims procedures and your rights and obligations under this warranty.

WHAT IS COVERED: This Limited Warranty applies only to Regal boats beginning with model year 2017.

LIFETIME LIMITED STRUCTURAL DECK & HULL WARRANTY: Regal Marine Industries, Inc. warrants to the original retail purchaser of this boat if purchased from an authorized Regal dealer that the selling dealer or Regal will repair or replace the factory installed fiberglass if it is found to be structurally defective in material or workmanship for as long as the original retail purchaser owns the boat. For purposes of this Limited Warranty, the hull is defined as the single fiberglass casting which rests on the water. This Limited Warranty is subject to all limitations and conditions explained below.

FIVE-YEAR TRANSFERABLE LIMITED STRUCTURAL HULL WARRANTY: In addition to the Lifetime Limited Structural Hull Warranty, Regal offers a Transferable Five-Year Limited Structural Hull Warranty. Under the Five-Year Transferable Limited Structural Hull Warranty, Regal will repair or replace the fiberglass hull or deck if it is found to be structurally defective in material or workmanship within the first (5) years after the date of delivery to the original retail purchaser. Any remaining term of this Five-Year Limited Hull Warranty may be transferred to a second owner if within 60 days of purchase, the new owner registers the transfer with Regal and pays the established Limited Warranty transfer fee. Contact Regal Customer Service at the above address for details.

FIVE-YEAR LIMITED HULL BLISTER WARRANTY: Regal warrants that the Regal selling dealer or Regal will repair any underwater gelcoated surfaces of the hull against laminate blisters which occur as a result of defects in material or workmanship within (5) years of the date of delivery, provided that the original factory gelcoat surface has not been altered. Alternation would include but is not limited to damage repair; excessive sanding, scraping, sandblasting; or from improper surface preparation for application of a marine barrier coating or bottom paint, any of which shall void this Five-Year Limited Hull Blister Warranty. Proper preparation must be applied to the hull bottom if the boat is to be moored for periods in excess of (60) days. Regal Marine shall repair or cause to be repaired any covered laminate blisters based on the following prorated schedule. Less than three (3) years from delivery date - 100%, Three (3) to (4) years from delivery date - 50%, Four (4) to (5) years from delivery date - 25%.

Reimbursement shall be limited to one repair, not to exceed (\$100.00) dollars per foot of boat length prior to prorating. Regal's prior authorization for the method and cost of repair, must be obtained before repairs are commenced. All costs to transport the boat for repairs are the responsibility of the owner.

LIMITED GENERAL WARRANTY: In addition to above hull warranties, Regal warrants to the original purchaser of this boat if purchased from an authorized Regal dealer, that the authorized Regal dealer or Regal will repair or replace any parts found to be defective in materials or workmanship for a period of one (1) year from the date of delivery, subject to all exceptions, limitations and conditions contained herein.

LIMITED EXTERIOR FINISH WARRANTY: Regal warrants that the authorized Regal selling dealer or Regal will repair cosmetic defects in the exterior gelcoated finish including cracks, air voids or crazing for one year from the date of delivery, subject to all limitations and conditions contained herein. All warranty work is to be performed at a Regal dealership or other location authorized by a Regal Customer Service Manager after it is established to Regal's satisfaction that there is a defect in material or workmanship.

CUSTOMER OBLIGATIONS: The following are conditions precedent to the availability of any benefits under these limited warranties:

(a) The purchaser, who is not Regal's sales agent and is otherwise not in any general or sales agency relationship with Regal, must sign and the authorized Regal selling dealer, must submit to Regal the "NEW BOAT DELIVERY and ACCEPTANCE CHECKLIST" within fifteen (15) days of the date of delivery and such information must be on file at Regal.

(b) The purchaser must first notify the authorized Regal selling dealer from whom the boat was purchased of any claim under this Limited Warranty within the applicable Limited Warranty period and within a reasonable period of time (not to exceed thirty (30) days) after the defect is or should have been discovered.

(c) Regal will not be responsible to repair any condition or replace any part, (1) if the use of the boat is continued after the defect is or should have been discovered; and (2) if such continued use causes other or additional damage to the boat or component parts of the boat.

(d) Based on the authorized Regal selling dealer's knowledge of Regal's Limited Warranty policy and/or consultations with Regal, the dealer will accept the claim and arrange for appropriate repairs to be performed, or deny the claim if it is not within the Limited Warranty policy.

(e) The authorized Regal selling dealer will contact the Regal boat owner regarding instructions for delivery of boat or part for covered warranty repair if it is covered by the Limited Warranty.

ALL COSTS TO OR FROM THE BOAT AND/OR TRANSPORT OF THE BOAT FOR REPAIRS ARE THE RESPONSIBILITY OF THE OWNER.

(f) If the Regal boat owner believes a claim has been denied in error or the authorized Regal selling dealer has performed the warranty work in an unsatisfactory manner, the owner must notify Regal's Customer Service Department in writing at the address listed for further consideration. Regal will then review the claim and take appropriate follow-up action.

(g) Before bringing any action, claim, lawsuit, or otherwise seeking relief against Regal based on any alleged breach of any of the Limited Warranties, terms or conditions herein, the Regal Boat owner must contact Regal's Customer Service Department Directly allow Regal, beyond those efforts made by its authorized Regal dealer, notice an opportunity to cure any alleged breach of any of the terms of any of the Limited Warranties.

WARRANTY EXCEPTIONS: THIS LIMITED WARRANTY does not cover, the following are not warranted are excluded from the terms of the Regal Limited Warranty and the following terms apply to any Regal Limited Warranty.

- (a) Engines, drives, controls, propellers, batteries, metal plating or finishes, windshield breakage, leakage, fading and deterioration of paints, canvas, vinyl, upholstery and fabrics;
- (b) Gelcoat surfaces including, but not limited to discoloration or blistering except as noted above;
- (c) Accessories and items which were not part of the boat when shipped from the Regal factory, or which carry their own individual warranty and/or any damage caused by such accessories or items;
- (d) Damage caused by one or more of the following: misuse, accident, corrosion, galvanic corrosion, negligence, lack of proper maintenance, or improper trailering;
- (e) Any boat used for racing, or used for rental or commercial purposes;
- (f) Any boat operated contrary to any instructions furnished by Regal, including instructions and guidance provided in the Regal Owner's Manual, or operated in violation of any federal, state, Coast Guard or other governmental agency laws, rules, or regulations;
- (g) The limited warranty is void if alterations have been made to the boat;
- (h) Transportation of boat or parts to and/or from the REGAL factory or service location;
- (i) Travel time or haul outs, loss of time or inconvenience;
- (j) Any published or announced catalog performance characteristics of speed, fuel and oil consumption, and static or dynamic transportation in the water;
- (k) Any boat that has been re-powered beyond Regal's power recommendations;
- (l) Boats damaged by accident and boats damaged while being loaded onto, transported upon or unloaded from trailers, cradles, or other devices used to place boats in water, remove boats from water or store or transport boats on or over land;
- (m) Any item repaired, replaced or modified under the terms of this warranty does not in any way prolong, extend or change any terms set forth in this limited warranty;
- (n) Water damage to, dry rot to, condensation to, or absorption by interior surfaces, wood structures or polyurethane foam; interior wood including, but not limited to mold, bleeding and/or discoloration as a result of condensation or moisture or water continually contacting the plywood causing staining to upholstery, carpet or other interior surfaces;
- (o) Costs or charges derived from inconvenience or loss of use, commercial or monetary loss due to time loss, and any other special, incidental or consequential damage of any kind or nature whatsoever;
- (p) Regal reserves the right to improve the design or manufacture process of Regal boats without obligation to modify previously produced product;

NO WAIVER OF THESE TERMS: The terms, conditions, limitations and disclaimers contained herein cannot be waived except by the Customer Service Manager of Regal. Any such waiver must be in writing. Neither the dealer, nor the customer, nor any service, sales and/or warranty representative of Regal is authorized to waive and/or modify these conditions, limitations and/or disclaimers.

EXCEPT AS SET FORTH HEREIN OR ON ANY OTHER WRITTEN EXPRESS LIMITED WARRANTIES BY REGAL, THERE ARE NO OTHER WARRANTIES EITHER EXPRESSED OR IMPLIED PROVIDED BY REGAL ON THIS BOAT. ALL OTHER WARRANTIES, EXPRESS OR IMPLIED, INCLUDING IMPLIED WARRANTIES OF FITNESS AND MERCHANTABILITY, ARE EXPRESSLY EXCLUDED. REGAL FURTHER DISCLAIMS ANY LIABILITY FOR ECONOMIC LOSS ARISING FROM CLAIMS OF PRODUCT FAILURE, NEGLIGENCE, DEFECTIVE DESIGN, MANUFACTURING DEFECT, FAILURE TO WARN AND/OR INSTRUCT, LACK OF SEAWORTHINESS, AND ANY OTHER THEORY OF LIABILITY NOT EXPRESSLY COVERED UNDER THE TERMS OF THIS LIMITED WARRANTY.

AS SET FORTH ABOVE, REGAL MAKES NO IMPLIED WARRANTY OF MERCHANTABILITY AND EXPRESSLY EXCLUDES ANY SUCH WARRANTY. TO THE EXTENT SUCH EXCLUSION IS NOT ALLOWED BY LAW OR AN IMPLIED WARRANTY OF MERCHANTABILITY IS ALLOWED BY LAW: (1) ANY IMPLIED WARRANTY OF MERCHANTABILITY THAT IS, AS A MATTER OF LAW, NOT PERMITTED TO BE EXCLUDED AS SET FORTH ABOVE, IS LIMITED TO ONE

YEAR FROM THE DATE OF DELIVERY TO THE FIRST RETAIL OWNER; (2) NEITHER REGAL NOR ANY SELLING DEALER SHALL HAVE ANY RESPONSIBILITY FOR LOSS OR USE OF THE BOAT, LOSS OF TIME, INCONVENIENCE, COMMERCIAL LOSS, INCIDENTAL OR CONSEQUENTIAL DAMAGES. SOME STATES MAY NOT ALLOW EXCLUSIONS OF IMPLIED WARRANTIES OR LIMITATIONS ON HOW LONG ANY IMPLIED WARRANTY LASTS, SO THE ABOVE LIMITATION MAY NOT BE APPLICABLE. SOME STATES MAY NOT ALLOW THE EXCLUSION OR LIMITATION OF INCIDENTAL OR CONSEQUENTIAL DAMAGES, SO THE ABOVE LIMITATIONS OR EXCLUSIONS MAY NOT BE APPLICABLE IN THOSE STATES. THIS WARRANTY GIVES THE OWNER SPECIFIC LEGAL RIGHTS, AND THE OWNER MAY ALSO HAVE OTHER RIGHTS WHICH VARY FROM STATE TO STATE.

THE TERMS AND CONDITIONS CONTAINED HEREIN, AS WELL AS THOSE OF ANY DOCUMENTS PREPARED IN CONJUNCTION WITH THE SALE OF THIS VESSEL MAY NOT BE MODIFIED, ALTERED OR WAIVED BY ANY ACTION, INACTION OR REPRESENTATIONS, WHETHER ORAL OR IN WRITING, EXCEPT UPON THE EXPRESSED, WRITTEN AUTHORITY OF A MANAGEMENT LEVEL EMPLOYEE OF REGAL. Some states do not allow limitations on how long an implied warranty lasts, so the above limitation may not apply to you. Regal's obligation with respect to this warranty is limited to making repairs to or replacing the defective parts and no claim for breach of warranty shall be cause for cancellation or rescission of the contract or sale for any boat manufacturer by REGAL MARINE INDUSTRIES, INC.

Regal will discharge its obligations under this warranty as rapidly as possible, but cannot guarantee any specific completion date due to the different nature of claims which may be made and services which may be required. Regal reserves the right to change or improve the design of its boats without obligation to modify any boat previously manufactured. This limited warranty gives you specific legal rights, and you may also have other rights which may vary from state to state. Regal shall in no way be responsible for any repairs not PRE-AUTHORIZED by a Regal Customer Service Manager or repairs performed by a repair shop not PRE-AUTHORIZED by a Regal Customer Service Manager.

ARBITRATION OF DISPUTES AND WAIVER OF JURY TRIAL

EXCEPT AS SPECIFICALLY EXCLUDED IN THIS LIMITED WARRANTY, PURCHASER, REGAL AND AUTHORIZED REGAL DEALER AGREE TO SUBMIT ANY AND ALL CONTROVERSIES, CLAIMS OR DISPUTES ARISING OUT OF OR RELATING TO THE BOAT AND THIS LIMITED WARRANTY AND ALL OTHER AGREEMENTS EXECUTED BY PURCHASER RELATED TO THE BOAT TO BINDING ARBITRATION. IT IS THE EXPRESS INTENT OF PURCHASER, REGAL AND DEALER THAT THIS ARBITRATION PROVISION APPLIES TO ALL DISPUTES, INCLUDING CONTRACT DISPUTES, TORT CLAIMS, FRAUD CLAIMS AND FRAUD-IN-THE INDUCEMENT CLAIMS, STATUTORY CLAIMS AND REGULATORY CLAIMS RELATING IN ANY MANNER TO THE BOAT AND THIS LIMITED WARRANTY.

IF ANY CONTROVERSY OR CLAIM DESCRIBED IN THIS ARBITRATION PROVISION IS DETERMINED FOR ANY REASON TO BE INELIGIBLE FOR ARBITRATION, AND FOR ANY CONTROVERSIES, CLAIMS, OR DISPUTES SPECIFICALLY EXEMPTED FROM ARBITRATION, THEN THOSE CONTROVERSIES, CLAIMS, OR DISPUTES SHALL INSTEAD BE DECIDED BY A JUDGE OF A COURT OF COMPETENT JURISDICTION, IN ORANGE COUNTY, FLORIDA, WITHOUT A JURY. PURCHASER, REGAL AND DEALER KNOWINGLY AND VOLUNTARILY WAIVE THE RIGHT TO A TRIAL BY JURY FOR ALL SUCH CONTROVERSIES, CLAIMS AND DISPUTES. PURCHASER, REGAL, AND DEALER UNDERSTAND THAT THERE SHALL BE NO JURY TRIAL, WHETHER THE CONTROVERSY OR CLAIM IS DECIDED BY ARBITRATION OR BY TRIAL BEFORE A JUDGE. NOTWITHSTANDING THE PROVISIONS OF THIS ARBITRATION AGREEMENT, WITH REGARD TO CONTROVERSIES AND/OR ENTITLEMENT TO POSSESSION OF EITHER THE BOAT OR ANY TRADE-IN, ANY PARTY HERETO MAY RESORT TO A JUDICIAL DETERMINATION (BY A JUDGE AND NOT A JURY). OF SUCH CONTROVERSIES, DISPUTES OR CLAIMS WITHOUT WAIVING ANY RIGHT TO DEMAND ARBITRATION WITH RESPECT TO ALL OTHER CONTROVERSIES, DISPUTES OR CLAIMS BETWEEN THE PARTIES A MORE SPECIFICALLY SET FORTH IN THIS ARBITRATION PROVISION.

ALL ARBITRATIONS SHALL PROCEED THROUGH THE AMERICAN ARBITRATION ASSOCIATION AND BE SUBJECT TO ITS COMMERCIAL ARBITRATION RULES, EXCEPT AS SET FORTH HEREIN. THE ARBITRATORS SHALL HAVE THE AUTHORITY TO AWARD ANY FORM OF RELIEF THAT COULD BE PROPERLY AWARDED IN A CIVIL ACTION IN THE STATE OF FLORIDA FOR THE TYPE OF CLAIMS PRESENTED, SUBJECT HOWEVER, TO ALL LIMITATIONS, PREDICATES, AND CONDITIONS COVERING SUCH REMEDIES OR RELIEF UNDER FLORIDA LAW.

THE PURCHASER, REGAL OR DEALER MAY DEMAND ARBITRATION OF A CLAIM BY FILING A WRITTEN DEMAND FOR ARBITRATION, ALONG WITH A STATEMENT OF THE MATTER IN CONTROVERSY WITH THE AMERICAN ARBITRATION ASSOCIATION, AND SIMULTANEOUSLY SERVING A COPY UPON THE OTHER PARTY. PURCHASER, REGAL AND DEALER AGREE THAT THE ARBITRATION PROCEEDING SHALL BE CONDUCTED IN ORANGE COUNTY, FLORIDA UNLESS OTHERWISE AGREED BY THE PARTIES. EACH PARTY AGREES TO BEAR THEIR OWN ATTORNEY FEES AND COSTS. THE FILING FEES AND ALL OTHER THIRD-PARTY COSTS FOR THE ARBITRATION, INCLUDING THE ARBITRATOR'S FEE SHALL BE PAID BY THE FILING PARTY INITIATING THE ARBITRATION. THE PREVAILING PARTY SHALL BE ENTITLED TO REIMBURSEMENT OF THEIR REASONABLE ATTORNEY FEES AND REASONABLE EXPENSES FROM THE NON-PREVAILING PARTY.

REGISTRATION INFORMATION:

Chapter 2

Safety On Board

Safety awareness can not be over emphasized. Safety on board needs to be the skippers number one priority. In this manual you will find many safety precautions and symbols to identify safety related items. Heed all safety precaution information. Remember, the skipper is responsible for the safety of his passengers and crew.

Safety Labels

Safety Precaution Definition:

Safety precautions are stated as caution, warning and danger signal words. They are highlighted in this manual by font design and symbol usage. Also, a notice heading is included which provides operation and maintenance information but is not hazard-related. An information label provides tips on a variety of topics. Become familiar and understand all safety precaution labels!

	WARNING
Potentially hazardous situation that, if not avoided, could result in death or serious injury.	

	DANGER
Immediate hazardous situation that if not avoided, will result in death or serious injury.	

NOTICE
General or specific information which is important to correct operation or maintenance, but is not hazard related.

	CAUTION
Indicates a potentially hazardous situation or unsafe practice that, if not avoided, may result in injury, property or product damage.	

Precautionary Labels

Read and understand all safety labels affixed to your Regal boat or found in this manual and the vendor literature. Many of the safety labels are posted close to the helm, aft cockpit, cabin and swim platform. The location of the labels may vary. Review the helm safety labels with passengers before disembarking. Use common sense to analyze the result of an action on board your vessel. Always think safety first!

NOTICE

DO NOT REMOVE OR COVER ANY PRECAUTIONARY LABELS. KEEP HARSH CHEMICALS AWAY FROM LABELS. IF A LABEL BECOMES ILLEGIBLE, CONTACT YOUR REGAL DEALER FOR ORDERING REPLACEMENTS.

General Boating Safety

We understand that you are eager to go boating. However, we strongly suggest that you thoroughly familiarize yourself and friends or members of your family with safe boating practices before setting out. Remember, that along with the freedom and exhilaration of boating comes the responsibility that you have for the safety of your passengers and other boaters who share the water with you.

Boating regulations vary from state to state. Check with your local and state authorities for the regulations pertaining to your area.

Check with local FM weather stations, U. S. Coast Guard, or on-line for the latest weather conditions.

Remember getting caught in severe weather is hazardous. Check weather conditions periodically while you are boating. If you are forced to operate your boat in a storm condition, take common sense precautions; wear PFD's, store gear, reduce speed and if possible head for safe refuge.

It is best to avoid operating your boat in foggy weather. When fog sets in, take bearings, log courses and speeds. You are required to emit a five second blast from your horn or whistle once every minute. Also, have your passengers wear PFD's and observe for oncoming vessels.

Operation in shallow water presents a number of hazards including sand bars and water levels influenced by tides. If the vessel strikes an underwater hazard, check for boat and engine damage. If the engine vibrates excessively after striking an underwater obstruction, it may indicate a damaged propeller. If you run aground, seek help by radio or flares.

Make sure your boat and equipment are in top condition. Do this by frequently inspecting the hull, engine and propulsion components.

You must provide a Coast Guard approved personal flotation device (PFD) for every person on board. These PFD's should be in good condition and easily accessible.

Insist that non-swimmers and children on board wear a PFD at all times. If you encounter rough weather conditions, make sure everyone on board is wearing a PFD, including yourself. Instruct your

passengers in how to put on their PFDs and be sure they know their storage location on the boat. Remember, in an emergency, a PFD that cannot be quickly located and worn is useless.

Never allow anyone to sit anywhere on the boat not specifically designed as seating. **While underway, ALWAYS insist passengers occupy a recognized seat as shown on page 215 of this**



manual.

Never drink and drive! As captain, you are responsible for the safety of your pas-

sengers. Alcohol and boating can be a dangerous combination. **DO NOT** mix them. Alcohol impairs the boat operators ability to make conscious decisions and react to emergency situations quickly.

Never overload your boat! An overloaded boat, or one with uneven weight distribution can be difficult to steer. **Never let people stand in bow area while underway as vision will be obstructed!!!**



CAUTION

READ AND UNDERSTAND THE SEATING ARRANGEMENT DRAWING IN THE TECHNICAL CHAPTER. THIS DRAWING DISPLAYS THE DESIGNATED SEATING ARRANGEMENT FOR A BALANCED LOAD AND VESSEL MAXIMUM PERSONS CAPACITY.

Use maximum caution when fueling. Never allow any smoke or flame nearby while you are fueling. **ALWAYS** check for fuel leaks and fumes when fu-

eling is completed. Be certain there is enough fuel aboard for your cruising needs. Include any reserve that might be needed should you change your plans due to weather or an emergency. Practice the “one-third rule: Use one-third of your fuel going out, one-third to return and retain one- third as a reserve.

Always check the weather before departure. Be particularly cautious of forecasted electrical storms and high winds.

Always have up-to-date charts aboard as a back-up to your plotter and auto pilot option. Charts can be obtained at your closet marina, on-line store or by contacting one of three federal government agencies.

Always file a float plan. Leave details of your trip with someone responsible who will be remaining on shore. Include expected return, plus name and phone number of a contact person in case of emergency.

Use care, courtesy and common sense when launching, docking or operating your boat.

Learn and obey the “Rules of the Road”. A weather resistant placard copy of the “Rules of the Road” is included in the on board Regal information packet. Additional information can be obtained from the U.S. Coast Guard Auxiliary or your local Power Squadron organization.

In case of emergency know the international distress signals for your VHF radio. The spoken word “MAYDAY” is the international signal of distress and is for emergency use only. Under no circumstances should this word be used, unless there is danger at hand.

General Boating Safety - Continued

Operation in shallow water presents a number of hazards including sand bars and water levels influenced by tides. If the vessel strikes an underwater hazard, check for boat and engine damage. If the engine vibrates excessively after striking an underwater obstruction, it may indicate a damaged propeller. If you run aground, seek help by radio or flares.

Make sure your boat and equipment are in top condition. Do this by frequently inspecting the hull, engine and propulsion components.

You must provide a Coast Guard approved personal flotation device (PFD) for every person on board. These PFD's should be in good condition and easily accessible.

Insist that non-swimmers and children on board wear a PFD at all times. If you encounter rough weather conditions, make sure everyone on board is wearing a PFD, including yourself. Instruct your passengers in how to put on their PFDs and be sure they know their storage location on the boat. Remember, in an emergency, a PFD that cannot be quickly located and worn is useless.

Never allow anyone to sit anywhere on the boat not specifically designed as seating. While underway, **ALWAYS** insist passengers sit in a seat and set an example by doing this yourself.

Never drink and drive! As captain, you are responsible for the safety of your passengers. Alcohol and boating can be a dangerous combination. **DO NOT** mix them. Alcohol impairs the boat operators ability to make conscious decisions and react to emergency situations quickly.

Never overload your boat! An overloaded boat, or one with uneven weight distribution can be difficult to steer.

Insist that passengers sit in seats while the vessel is making headway!! See page 215 for seating positions while underway. No one to be standing in the bow area while underway as visibility will be obstructed!!!

Posted speed limits, swimming areas, "no wake" zones and other restrictions should be red-flagged. They are so noted for a reason. Sensible boat use, plus courtesy, equals enjoyable and safe boating.

It is your responsibility to stay abreast of all federal, state and local rules, as some laws or regulations may change or be different from state to state. Contact your local boating agencies for updated information.

We can not stress safety enough! Remember, there are no brakes on your boat, and the water current and wind velocity both affect your ability to respond.

Required Safety Equipment

Personal Flotation Devices:

All personal flotation devices (PFD's) must be Coast Guard approved, in good working condition, and must be the correct size for the wearer. All PFD's must be readily accessible. This means being able to wear them in a reasonable amount of time in case of an emergency (fire, boat sinking, etc.). They should not be stored or locked in closed areas. Also, make sure that all coverings are removed such as plastic from any PFD's. Throw-able devices such as a ring buoy need to be available for immediate deployment. A PFD should be worn at all times when your boat is operating on the water. A PFD may save your life, but it must be worn to do so.

As a minimum U. S. Coast Guard requirement all recreational boats must carry one type I, II, III, or V PFD (wearable) for each person aboard. See the explanation following for each type. For type V to be counted they must be used according to the label instructions. In addition, all boats over 16' must carry one Type IV (throw-able) PFD.

Some states require that PFD's be worn by children of specific ages at all times. Check with local and state boating agencies for particular requirements in your state before taking children on the water. Child life jackets are classified by the child's weight and should like all life jackets be sized before being purchased.

Remember PFD's will not necessarily keep you from drowning, even though they are designed to keep a person from sinking. When purchasing PFD's make sure it safely fits the person wearing it. It is a good idea to test PFD's in a life guarded

shallow pool before venturing on the water.

Refer to the USCG minimum equipment requirements at the end of this chapter. It is meant to be a guide only. Contact state and local agencies for additional equipment requirements. Remember as the captain of your vessel you are responsible for its safe operation.



Type I:

Also known as an off-shore jacket, it provides the most buoyancy. It is a PFD for all waters and is especially useful in rough waters where rescue may encompass additional time. It is designed to turn most unconscious users in the water to a true face-up position. Type I PFD is available in adult & child sizes Buoyancy minimum poundages are 15.5 adult, 11 medium child, and 7 for small child and infants.

Type II:

Also known as near-shore buoyant vest, it is recommended for calm, inland water where rescue time will be minimal. It will turn some unconscious people face-up in the water but not as numerous as Type I. They are available in adult, medium child, along with infant and small child sizes.

Type III:

Known as a flotation aid it is good for calm, inland water or where there is a chance for quick rescue. It is designed so wearers can place themselves in a face-up position in the water. The wearer may have to tilt their head back to avoid face-down positions. Type III offer the same buoyancy minimum poundages as the Type II. They are generally the most comfortable for continuous wear. Float coats, fishing vests, and vests featuring designs for various sport activities are examples of Type III.

Type IV:

Intended for calm, inland water with heavy vessel traffic, where help is constantly present. It is designed to be thrown into the water for someone to grab on to and held until rescued. It is not designed to be worn. Type IV includes ring buoys, buoyant cushions, and horseshoe buoys.

Type V:

Also known as a special use device this is the least bulky of all PFD's. It contains a small amount of inherent buoyancy, and an inflatable chamber. It is rated even to a Type I, II, or III PFD (as noted on the jacket label) when inflated. Some Type V devices provide significant hypothermia protection. Varieties include deck suits, work vests, board sailing vests and Hybrid PFD's. Remember that this Type V type PFD may be carried instead of another PFD only if used according to the approval condition on the label.

Note: A water skier or wake boarder is considered on board the vessel and a PFD is required for the purposes of compliance with the PFD carriage requirements. It is advisable and recommended for a skier or wake boarder to wear a PFD designed to withstand the impact of hitting the water at a high speed. "Impact Class" marking on the label refers to PFD strength, not personal protection. Some state laws require a skier or wake boarder to wear a PFD.

PFD's For Pets:

If you are a skipper who needs to have his pet dog or cat on board or dock side then a PFD is recommended. The PFD will aid you in finding the pet if it should fall overboard. The device must fit the pet properly. Also, it may take a bit of training before the pet is comfortable wearing the PFD. Normally, dogs are easier to train wearing a life vest than a cat. Marine type retail stores will fit a pet to a PFD by body weight.

Maintaining Your PFD's

A PFD is only useful if it is well maintained. Always be aware of PFD age since it has a life expectancy like any other piece of equipment.

- ✓ Check periodically for broken zippers, frayed webbing, water soaked kapok bags, missing straps, and sewing that has become undone.
- ✓ Clean each PFD with mild soap and water only. Again, let dry sufficiently before storing.
- ✓ Keep PFD's out of grease and oil since they can deteriorate the jacket inner and outer materials.
- ✓ Check any kapok-bagged jackets by squeezing. If you hear air escaping the bag is defective and the PFD should be thrown away.
- ✓ Grab the cover with the fingers. If the cover material rips, the PFD is rotted and should be thrown away.
- ✓ If the kapok bag is hard the PFD should be discarded.

Fire Extinguishers

General Information:

Fire extinguishers are classified by a letter and numeric symbol. The letter references the type of fire the unit is designed to extinguish.

For example, type B extinguishers commonly used on boats are designed to put out flammable liquids such as grease, oil and gasoline.

The number indicates the general size of the extinguisher (minimum extinguishing agent weight). Coast Guard Approved extinguishers are identified by the following marking on the label:

"Marine Type USCG Approved, Size..., Type..., 162.028/.../...", etc.

MINIMUM PORTABLE FIRE EXTINGUISHERS REQUIRED		
VESSEL LENGTH	NO FIXED SYSTEM	WITH FIXED SYSTEM
LESS THAN 26'	1 B-I	0
26' TO LESS THAN 40'	2 B-I or 1 B-II	1 B-I
40' TO 65'	3 B-I or 1 B-I & 1 B-II	2 B-I or 1 B-II

FIRE EXTINGUISHER CONTENTS				
CLASS	FOAM IN GALS.	CO2 IN LBS.	DRY CHEM IN LBS.	HALON IN LBS.
B-I	1.25	4	2	2.5
B-II	2.5	15	10	10

U. S. Coast Guard approved fire extinguishers are required on all Regal boats. Besides the minimum Coast Guard requirements always check state and local agencies for additional requirements and equipment.

Coast Guard approved extinguishers are hand-portable, either B-I or B-II classification. U. S. Coast Guard approved hand-portable and semi-portable extinguishers contain a metal plate that shows the manufacturers name and extinguisher type, capacity and operating instructions. They have a special marine type mounting bracket which keeps the extinguisher solidly mounted until needed. The extinguisher needs to be mounted in a readily accessible location but one that will not be bumped by people while underway. All approved extinguishers shall have an indication gauge.

U.S.C.G Approved Fire Extinguisher Types & Features:



The dry chemical agent is widely used because of its convenience and low cost. The extinguisher canister is filled with a white dry chemical powder along with a pressurized gas. It is a

good idea to shake this type periodically because they tend to “pack” on the canister bottom.

The foam type uses a chemical foaming agent plus



water and is best when used for fires involving flammable liquids- solvents, gasoline, oil, grease and various paints. It will work on fires involving

rubber, plastics, cloth, wood, and paper. It leaves a messy residue. Do not use this extinguisher for electric fires.



The carbon dioxide unit uses CO₂ gas under high pressure, with a funnel discharge hose usually swivel mounted. This extinguisher leaves no residue

and does not cause interior engine harm. To ensure workability, weigh the unit annually. A 10% maximum weight variance is allowed.

Another type of liquefied gas used today is FE-241. This gas is colorless and odorless, heavier than air and sinks to the lower bilge to extinguish fires. Since the year 2000 ingredients have changed to a more environmental friendly formula (Chlorotetrafluoroethane or FE-241). FE-241 is used in portable-hand units along with making up the majority of boat automatic fire extinguishing systems. The canister needs to be weighed once a year. These clean agent units feature a dash mount indicator.

Refer to the information regarding fire prevention in this manual.

Pyrotechnic Devices:

Pyrotechnic visual distress signals must be Coast Guard approved, be ready for service and must be readily accessible. They all display a marking which is the service life, which must not have expired. A minimum of 3 devices are required for the day and 3 devices for night.

Some devices meet both day and night requirements. Pyrotechnic devices should be stored in a cool, dry location. Most of these devices can be purchased in an highly visible (orange) watertight container. Types of Coast Guard approved pyrotechnic distress signals and associated devices are:

- Pyrotechnic red flares, hand-held or aerial type.
- Pyrotechnic orange smoke, hand-held or floating type.
- Launchers for parachute flares or aerial red meteors.

All in all, each distress signal has certain advantages and disadvantages.

There is no distress signal that is best under all situations. Pyrotechnics are recognized worldwide as superior distress signals. A downfall is they emit a very hot flame that can cause burns and or ignite flammable materials. Pistol launched and hand-held parachute flares operate consistent with firearms and therefore must be carefully handled. Check with local and state regulations since some of these device are considered firearms and are prohibited.

It is best to carry red aerial flares which are visible

from a greater distance. Also, the red parachute flares burn for longer periods and therefore are more likely to be seen by another vessel.

Non-Pyrotechnic Devices:

Non-pyrotechnic devices must all be in serviceable condition, readily accessible, and must be certified by the manufacturer to comply with U. S .C. G standards. They include:

- Orange distress flag.
- Electric distress light.

The distress flag is for day use only. It must be 3 x 3 or larger with a black square and ball on an orange background. It can be spotted when attached to a boat hook, long fishing rod, or paddle with the person waving the flag back and forth overhead.

The electric distress light is for night use only flashing the international SOS distress signal (... _ _ _ ...).

Under Inland Navigation Rules, a high intensity white light that flashes at regular intervals from 50-70 times per minute is considered a distress signal.

Remember that regulations prohibit the display of visual distress signals on the water under any circumstances except when assistance is required to prevent immediate or potential danger to passengers on a vessel.

International Distress Signals



BLACK SQUARE
AND BALL ON
ORANGE BACKGROUND



CODE FLAGS
NOVEMBER
& CHARLIE



SQUARE FLAG
& BALL



PERSON
WAVING
HANDS

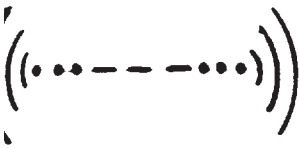

MORSE
CODE S.O.S.



"MAYDAY"
BY
RADIO

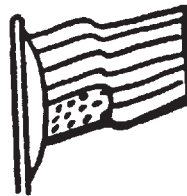

ENSIGN
UPSIDE
DOWN



PARACHUTE
RED FLARE



RED METEOR
FLARES



SMOKE



FOG HORN
SOUNDED
CONTINUOUSLY



GUN FIRED AT
1- MINUTE
INTERVALS

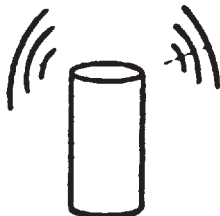

POSITION
INDICATING
RADIO BEACON



DYE MARKER
(ANY COLOR)



HAND-HELD
FLARE

Sound Producing Devices

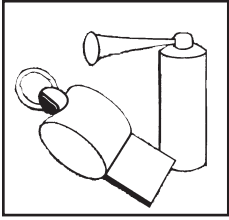

According to both Inland and International Rules, all boats must carry a way of producing an efficient sound signal. If your vessel is 12 meters (39'

4") or longer, a power whistle or power horn and bell must be carried. Bell mouth must be at least 7 7/8" diameter. The sound signal made in all cases must be capable of a four or six second blast audible for one half mile. See the section discussing bridge and whistle signals for more information.

Radio Communications:

VHF radios are used for distress and ship to shore and ship to ship communications today. Learn the specialized messages such as Mayday, Mayday, Mayday. It is only used when life or vessel is in imminent danger.



Many of the more recent VHF's feature DSC capability which offers the ability to

place and receive digital calls directly with vessels and shore stations including USA and Canadian Coast Guards. Channel 70 is reserved exclusively for DSC calls. Refer to the VHF owner's information since you need to establish a Mobile Maritime Safety Identity (MMSI) number before using the DSC feature. A MMSI number identifies each DSC radio, like a telephone number. The FCC requires a ship station license for all vessels equipped with a marine VHF radio.

Navigation Lights:

The U. S. Coast Guard requires recreational boats operating at night to display navigation lights between sunset and sunrise along with other periods of reduced visibility.

Navigation lights help avoid collisions by improving the night visibility of vessels. Red and green directional lights, white stern lights, white masthead lights and white all-around lights must be displayed in specified positions, depending on boat size, and mode of operation.

Marine Sanitation Devices:

Recreational vessels under 65' with installed toilet facilities must have an operable marine sanitation device (MSD) on board. Vessels 65' and under may use Type I, II, or III MSD's. All installed MSD's must be U.S. Coast Guard certified. The MSD's are labeled to show conformity to the regulations.

Navigation Rules:

The navigation rules establish actions to be taken by vessels to avoid collision. They are divided into Inland/International. Operators of vessels 39.4' or more shall have on board and maintain a copy of the Inland navigation rules.

Navigation Light Rules

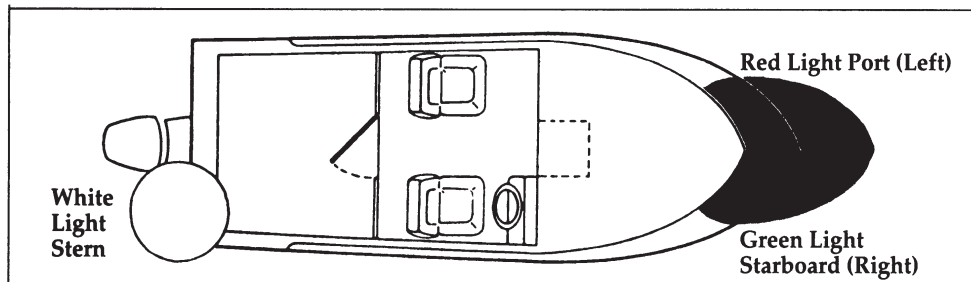

Location of lights on vessel	Visible Range		Degrees of arc lights
	Less than 12 m.	12 m. but less than 20 m.	
Masthead	2	3	225°
All-round	2	2	360°
Side lights	1	2	112.5° each color
Stern light	2	2	135°

Boats less than 12 meters in length

Motorboats or sailboats using power: The lighting arrangements to figure 1, 2 or 3 may be used.

Sailboat using sails alone: The lighting arrangements in figure 4, 5 or 6 may be used.

Boats 12 meters but less than 20 meters in length

Motorboats or sailboats using power: The lighting arrangements to figure 1 or 2 may be used.

Sailboat using sails alone: The lighting arrangements in figure 4, 5 or 6 may be used.

Location of lights

Lights should be located as shown in the drawings.

The masthead light (forward white light in figures 1, 2 and 7d) must be at least one meter higher than the colored lights on a boat less than 12 meters in length and at least 2.5 meters above the gunwale on a boat 12 meters but less than 20 meters in length.

Exceptions

Motorboat or sailboat using power, built before December 24, 1980: The lighting arrangement in figure 1, 2 or 3 may be used. However, the arrangement in figure 3 is not acceptable on a boat that is 12 meters or longer on international waters.

figure 1

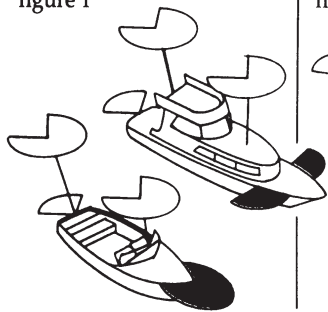

figure 2

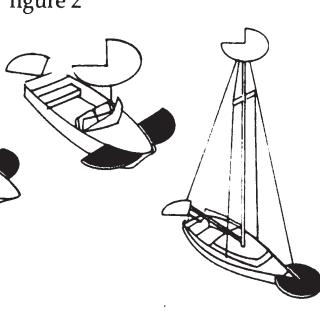

figure 3

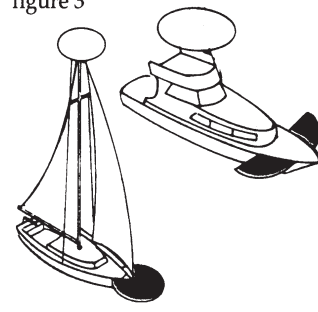

figure 4

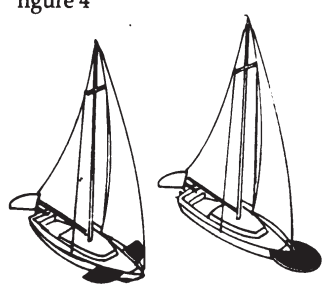

figure 5

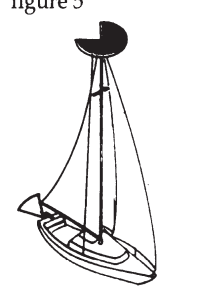

figure 6

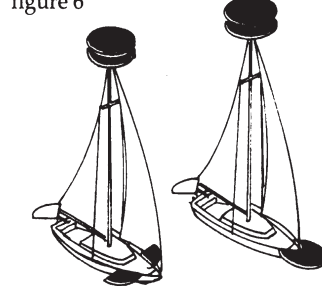
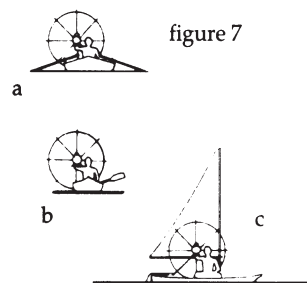

figure 7



Sailboat using sail alone, less than 7 meters in length: If impractical to display lights in figure 4, 5 or 6, a single white light may be displayed in time to prevent a collision (figure 7c).

Row Boats or Paddle Boats
One all-round white light ready to display in time to prevent a collision (figure 7 a or b).

Great Lakes

figure 7d



Motorboat or sailboat using power on Great Lakes: The lighting arrangements in figure 7d may be used instead of the arrangements in figures 1 and 2.

DISCHARGE OF OIL PROHIBITED

THE FEDERAL WATER POLLUTION CONTROL ACT PROHIBITS THE DISCHARGE OF OIL OR OILY WASTE INTO OR UPON THE NAVIGABLE WATERS OF THE UNITED STATES, OR THE WATERS OF THE CONTIGUOUS ZONE, OR WHICH MAY AFFECT NATURAL RESOURCES BELONGING TO, APPERTAINING TO, OR UNDER THE EXCLUSIVE MANAGEMENT AUTHORITY OF THE UNITED STATES, IF SUCH DISCHARGE CAUSES A FILM OR DISCOLORATION OF THE SURFACE OF THE WATER OR CAUSES A SLUDGE OR EMULSION BENEATH THE SURFACE OF THE WATER. VIOLATORS ARE SUBJECT TO SUBSTANTIAL CIVIL PENALTIES AND/OR CRIMINAL SANCTIONS INCLUDING FINES AND IMPRISONMENT.

Marpol Treaty:

The USCG now enforces the International Convention for the Prevention of Pollution from ships, referred to commonly as the MARPOL TREATY (marine pollution). This international treaty prohibits the overboard dumping of all oil, garbage, ship-generated plastic and chemicals. There is a placard on board your boat (typical example shown below) that explains the garbage and plastic dumping laws in detail.

Immediately notify the USCG if your vessel discharges oil or hazardous substances in the water. Call toll free 1-800-424-8802. Report the following information: location, source, size, color, substances and time observed.

No vessel may intentionally drain oil or oily waste from any source into the bilge of any vessel. A bucket or bailer is suitable as a portable means of discharging oily waste.

The placard noted above is normally located in the engine compartment or may be attached to the engine hatch.

Garbage Discharge

THE DISCHARGE OF PLASTIC OR GARBAGE WITH PLASTIC INTO ANY WATERS IS PROHIBITED. THE DISCHARGE OF ALL GARBAGE IS PROHIBITED IN THE NAVIGABLE WATERS OF THE UNITED STATES AND IN ALL OTHER WATERS, WITHIN THREE NAUTICAL MILES OF THE NEAREST LAND.		
THE DISCHARGE OF DUNNAGE, LINING, AND PACKING MATERIALS THAT FLOAT IS PROHIBITED WITHIN 25 NAUTICAL MILES FROM THE NEAREST LAND.	OTHER UNGROUND GARBAGE MAY BE DISCHARGED BEYOND 12 NAUTICAL MILES FROM THE NEAREST LAND.	OTHER GARBAGE GREATER THAN ONE INCH MAY BE DISCHARGED BEYOND THREE NAUTICAL MILES FROM THE NEAREST LAND.
A PERSON WHO VIOLATES THE ABOVE REQUIREMENTS IS LIABLE FOR A CIVIL PENALTY OF UP TO \$25,000, A FINE OF UP TO \$50,000, AND IMPRISONMENT FOR UP TO FIVE YEARS FOR EACH VIOLATION, REGIONAL, STATE, AND LOCAL RESTRICTIONS ON GARBAGE DISCHARGES MAY ALSO APPLY.		

The act to prevent pollution from ships places limitations on the discharge of garbage from vessels. It is illegal to dump plastic trash anywhere in the ocean or navigable waters of the United States. Also, it is illegal to discharge garbage in the navigable waters of the United States, including the Great Lakes. The discharge of other types of garbage is allowed outside certain specified distances from shore as determined by the nature of that garbage.

United States vessels of 26 feet or longer must display in a prominent location, a durable placard at least 4" x 9" notifying crew and passengers of discharge restrictions.

USA vessels of 26' or longer equipped with a galley and berthing must have a written Management Plan describing the plan for collecting, processing, storing and discharging garbage, and designate the person charged with carrying out the plan.

The placard noted below is usually found near a galley, inside the engine hatch area or close to a receptacle.

USCG MIN. EQUIPMENT REQUIREMENTS

Use the chart below as a guideline for assuring your vessel is outfitted to meet USCG standards. Remember to check with local and state authorities for additional equipment requirements. Make sure your vessel certificate of numbers are on the boat, updated and displayed properly according to state requirements. Keep the paperwork on board in a watertight and safe environment. On documented vessels keep both the original and current certificate on board stored in a safe, dry, and accessible location. Also, on documented vessels make sure the vessel name/hailing port are marked on the hull exterior with letters not less than 4" in height. In addition, the Official Number must be permanently affixed on a clearly visible interior structure part of the boat-block type Arabic numbers not less than 3" in height.

Life Rafts

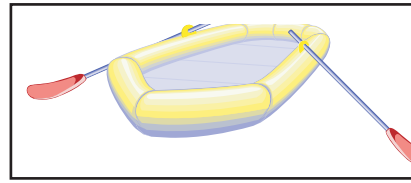

Inflatable life rafts are recommended for ocean going and vessels

operating in a large body of water like the Great Lakes. They provide a shelter for extended periods. If used, make sure it is large enough for all aboard and contains the proper emergency equipment pack. Also, periodically have the unit professionally serviced. Make sure the life raft is Coast Guard approved since it would require meeting a number of stringent material and performance standards.

USCG Minimum Equipment Requirements for Recreational Vessels

Boat Size in Feet	16'	26'	40'	65'	165'
Personal Flotation Devices¹	One Type I, II, III, or V per person		One Type I, II, III, or V per person plus one Type IV throwable		
Fire Extinguishers²					
No Fixed System	One B-I, any type		One B-II or Two B-I	One B-II and one B-I, or three B-I	One or more B-II (vessels 0-50 tons gross) Two or more B-II (vessels 50-100 tons gross)
With Fixed System	No Portables Required		One B-I	Two B-I or one Class B-II	
Visual Distress Signals	Night signals required when operating at night		Minimum of three day-use and three night-use (or three day/night combination) pyrotechnic devices ⁵		
Sound Producing Devices	Horn or whistle recommended to signal intentions or signal position		One bell, and one whistle or horn required to signal intentions or position		
Backfire Flame Arrestor	One CG-approved device on each carburetor of all gasoline-powered engines built after April 1940, except outboard motors				
Ventilation	CG standard system required on gasoline powered vessels with enclosed engine compartments built after August 1980				
Navigation Lights					
Under Power ^{3,4}	Sidelights, Stern Light and Masthead ^{6,7}				
Under Sail	Sidelights and Stern Light ^{6,8}				
Rowing	Same as "Under Sail"				
At Anchor	All-round light, 2nm (at night) or black anchoring ball (during the day) when outside a designated anchorage				
Visibility Range	1nm Sidelights, 2nm all others		3nm Masthead, 2nm all others		5nm Masthead, 2nm all others
Pollution Regulations	"Honor system" (no plaques required)		5" x 8" Oil Discharge placard and 4" x 9" Waste Discharge placard		
Marine Sanitation Devices	Vessels with installed toilet facilities must have an operable, CG-certified Type I, II or III Marine Sanitation Device (MSD). Subject to local laws!				Type II or III MSD only
Navigation Rules	Familiarity with the Inland Navigation Rules required		The Inland Navigation Rules ("Rules of the Road") must be kept on board		

<ol style="list-style-type: none"> <i>Pfd's must be CG approved, wearable by the intended user and readily accessible.</i> <i>Fire extinguishers required on boats with enclosed engine compartments (not outboards), enclosed living spaces or permanent fuel tanks.</i> <i>Sailboats operating under engine power are considered power driven and must follow the "Under Power" rules. During the day, motorsailing vessels are required to fly a motoring cone.</i> <i>Power-driven vessels under 23' and under 7 knots can substitute a white lantern or torch in place of the required lights.</i> 	<ol style="list-style-type: none"> <i>Non-pyrotechnic substitutes: 1 orange distress flag (day-use) and 1 electric SOS signal light (night-use).</i> <i>All boats under 65' can substitute a single bi-color light for sidelights.</i> <i>Boats under power under 40' can substitute a single all-round light for separate stern and masthead lights.</i> <i>Boats under sail under 40' can substitute a tri-color light for separate sidelights and stern light.</i>
---	---

Additions to these requirements are prescribed by some individual state laws. Check your state's Boating Safety Handbook for a complete list.

Exhaust & Carbon Monoxide

Carbon monoxide (CO) in exhaust can be hazardous, especially from gasoline engines, gasoline generators, grills, stoves, space heaters and on a much smaller degree diesel engines.

CO is a natural by-product of the gasoline engine using an artificial spark. Diesels on the other hand detonate fuel using pressure and temperature. Looking at the two engines another way, gasoline engines use much more oxygen up in the combustion process which contributes to a much higher CO build-up. Although diesels do produce a small amount of CO the combustion process operates with much greater amounts of oxygen which the end result is a much lower CO level.

Ensure that you read the information and follow all the recommendations regarding CO.

Familiarize your crew, passengers and yourself with the sources, symptoms and possible effects of carbon monoxide poisoning. Remember that boats in the same general vicinity can cause your vessel to accumulate dangerous CO levels in the cabin and or in the cockpit.

 **WARNING**

AVOID SERIOUS INJURY OR DEATH
FROM CO POISONING!
DO NOT OPERATE THE BOAT WITH PEOPLE
HOLDING ON TO THE SWIM PLATFORM
OR WITH PEOPLE IN THE WATER.

For safety sake avoid the following:

1. Do not park by other boats with their engine idling or generator cycling for an extended period of time.
2. Do not disable the carbon monoxide alarms that come with your Regal boat. Test the units in accordance with the alarm manufacturers instructions.
3. Do not operate an engine for extended periods of time while in a confined area or where exhaust outlets face a sea wall or bulkhead.
4. Do not operate the engine for an extended period of time with the canvas in the upright and installed position.
5. Do have the engine exhaust system inspected when the boat is in for service.
6. Persons sleeping can easily be overcome by carbon monoxide without realizing it. Do not sleep on board while an engine or generator is running close-by.
7. Do not operate your vessel for extended periods with the bow up in slow cruise conditions especially close behind a vessel being towed or one operating at slow speeds.
8. When underway open all hatches, windshield vents, and main cabin entry door to allow proper airflow from bow to stern.

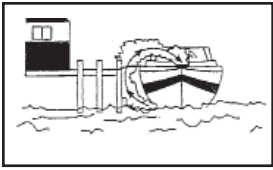

Blockage of exhaust outlets can cause carbon monoxide to accumulate in the cabin and cockpit area even when the hatches, windows, portholes and doors are open. Sea walls and other confined spaces can cause CO levels to be dangerously elevated.

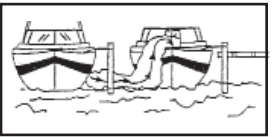

Exhaust from another vessel alongside your boat, while docked or anchored, can emit poisonous CO gas inside the cabin and cockpit areas.

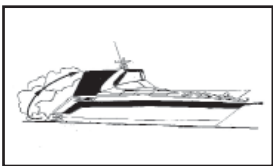

The “station wagon effect” or back drafting can cause CO gas to accumulate inside the cabin, cockpit/hardtop or bridge areas when the boat is underway, using protective weather coverings (canvas), high bow angle, improper or heavy loading, slow speeds, or at rest. This can occur when traveling behind another boat.

How does CO affect us?

In high concentrations, CO can be fatal in minutes. However, the effects of lower concentrations over a extended period of time can be just as lethal.

Our blood uses hemoglobin to carry the oxygen we breathe to different body parts. Unfortunately, hemoglobin carries CO more readily than it does oxygen. The result is when we breathe in CO it replaces oxygen in our blood and we begin to suffocate. Also, when we are removed from the CO source it remains in our blood for hours causing long term effects. People have been known to become sick and even lose consciousness hours after exposure.

Carbon monoxide accumulation requires immediate

attention! Thoroughly ventilate cabin and cockpit areas. Determine the probable source of the carbon monoxide and correct the condition immediately. Anyone with symptoms of CO poisoning should be placed in a fresh air environment and medical attention found immediately. Regal has installed CO detectors on your boat. Have these detectors professionally calibrated at regular intervals according to the equipment manufacturer’s recommendations.

A Few Notes About Diesel/CO Poisoning

The diesel engine under normal combustion produces much smaller amounts of CO. Therefore, it is far less likely to be fatal to a healthy person. Other factors including weather, temperature and engine condition can greatly affect the unsafe build-up of CO. The best approach is to respect and treat the engine, generator and other vessel components the same way you would a gasoline propulsion system giving particular attention to the sources and possible effects of CO poisoning!

Diesel exhaust in the combustion process produces various components and the captain must be aware that the build-up of these select components over a period of time can cause CO or seasickness like symptoms.

These include carbon dioxide, carbon monoxide (CO), nitrogen dioxide, nitric oxide, sulfur dioxide and others.

A healthy person breathing in sulfur dioxide over a period of time through a diesel engine or generator exhaust can develop nausea. This condition is not life threatening but the person may exhibit CO poisoning or seasickness symptoms. Just never rule out that it could be CO poisoning! Immediately find the source of the problem and move the individual to a fresh air environment!

Symptoms of excessive exposure to carbon monoxide (CO) are:

- Dizziness
- Drowsiness
- Nausea
- Headache
- Ringing in the ears
- Throbbing temples
- Watering, itchy eyes
- Flushed appearance
- Inattentiveness
- Incoherence
- Fatigue or vomiting
- Convulsions

DANGER

CARBON MONOXIDE IS A TASTELESS, ODORLESS AND INVISIBLE GAS THAT CAN CAUSE DISCOMFORT, SEVERE ILLNESS, AND EVEN DEATH. EXERCISE CAUTION WHILE OPERATING GENERATOR OR ENGINES IN CONFINED SPACES OR AT DOCK SIDE. DO NOT ALLOW HULL EXHAUST OUTLETS TO BECOME BLOCKED OR EXHAUST FUMES CAN BECOME TRAPPED IN AND AROUND THE CONFINES OF YOUR BOAT. DURING IDLE AND SLOW CRUISE CONDITIONS, BILGE BLOWERS SHOULD BE USED.

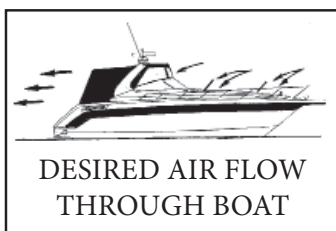

To help prevent carbon monoxide accumulation, ventilate your cabin and cockpit while

underway. Open a forward hatch, porthole or window to allow air to travel through the boat's interior and cockpit. See the illustration for desired airflow.

NOTE: Never occupy moored boat with engines running and/or canvas completely covering vessel.



WARNING

INSPECT THE EXHAUST SYSTEM. IMMEDIATELY REPAIR OR REPLACE LEAKING, CRACKED AND CORRODED, OR MISSING EXHAUST COMPONENTS.

- Before each trip inspect engine, generator and all CO detectors. All must be working properly.
- Make sure all exhaust hose clamps are in place.
- Look for exhaust leaking from the exhaust system components, indicated by rust and or black streaking, water leaks, or corroded or cracked fittings.
- Inspect all rubber exhaust hoses for burned or cracked areas. All rubber hoses should feel soft and be free of kinks.
- Visually verify that water exits at the engine exhaust outlet.
- Keep an ear tuned for changes in exhaust sound that may be an exhaust component malfunction.

Do Not Operate the Vessel If **Any** of the above conditions exist. Contact a marine professional!

NOTICE

CARBON MONOXIDE PRECAUTIONARY LABELS ARE LOCATED AT THE HELM, TRANSOM AND CABIN. ENSURE THAT ALL ABOARD READ AND UNDERSTAND THE SIGNS AND EFFECTS OF CARBON MONOXIDE (CO).

Boating & Alcohol



Operating a vessel while intoxicated became a specific federal offense effective in 1988. The ruling set federal standards for determining

when an individual is intoxicated. If the blood alcohol content (BAC) is .10% (.08 in some states) or higher for operators of recreational vessels being used only for pleasure are subject to a civil penalty up to \$1,000 or criminal penalty up to \$5,000, one year imprisonment or both. In some states the fines and imprisonment may increase significantly.

The effects of alcohol and drugs account for the highest single cause of marine accidents and deaths. Most deaths in boating accidents occur when someone falls into the water. Balance is one of the first things you lose when drinking alcohol or under the influence of drugs. The problem arises out of not knowing your balance is restricted.

Overall vision is reduced by alcohol especially at night, along with double or blurred vision. Peripheral vision is lessened which restricts seeing vessels or objects on the side. Also, color awareness decreases especially with red and green which happen to be the colors of boat navigation lights, buoys, and channel markers.

Alcohol will greatly increase your heat loss so it increases the effects of hypothermia. Finally, your ability to make correct judgements in emergency situations is greatly reduced. Alcohol takes away the brains ability to process information quickly and delays a persons reaction time.

Don't drink and drive!

Alcohol Myths & Facts:

Myth: Beer is less intoxicating than other alcoholic beverages.

Fact: One 12 oz. can of beer has about the same amount of alcohol as a 5oz. glass of wine or a shot of liquor.

Myth: Black coffee, fresh air, and a shower will sober the effects of alcohol.

Fact: After consuming alcohol time is the only thing that will sober you up. Our bodies average burning 1 oz. of alcohol every hour. If a person is drunk, it will take a person seven or more hours to sober up.

Myth: Telling if a person is too drunk to operate a vessel is easy.

Fact: Many experienced drinkers have learned to compensate for the visual effects of alcohol and can disguise their drunk condition.

Myth: You can judge if you are fit to operate a boat.
Fact: Judgement is one of the first elements you lose when drinking.

Boating Accidents

The following is a list of common causes of boating accidents. Be aware of them and take the necessary steps to ensure that yourself and crew are educated and prepared to act in an emergency.

1. Mixing boating and alcohol. Remember, the skipper is responsible for his crew, passengers and vessel.
2. Trying to reach the bow by the deck walk-around at unsafe speeds. Use the center walk-through.
3. Someone sitting on the bow, deck, or swim platform while underway.
4. Choosing a boating outing day with inclement weather, especially in high winds and thunderstorms in the forecast or staying out when bad weather is approaching.
5. Disembarking without checking all the fluids or systems, and especially fuel system components.
6. Not monitoring the boating traffic or possible obstructions around you.
7. Emergency communications equipment, signaling devices, and navigation lights not working.
8. Improper boat handling especially high speed turns in rough water. Using trim improperly.
9. Being too far from shore with inadequate fuel supply or navigational aids.
10. Passengers, especially children that are not

wearing the proper life saving devices.

11. Skipper or passengers not seated in the boat.

Reporting Boating Accidents:

According to the Federal Boat Safety Act of 1971 involving collision, accident or other casualty, the operator must make a formal report within 48 hours to the nearest state boating authority when the incident involves:

1. Death
2. Injury requiring treatment other than first aid
3. The disappearance of someone from a boat under death or injury circumstances.

A formal report must be made within 10 days for accidents involving more than \$2000 damage or complete loss of vessel.

For information regarding accident reporting, please call the Boating Safety Hot-line at: 800-368-5647.

If there is no state provision for reporting boating accidents a report must be made to the Coast Guard officer in charge, Marine Inspection Unit nearest to the accident site or USCG station.

Federal Regulations Regarding Vessel Security

Federal maritime regulations contain specific information when operating near naval vessels, oil tankers and cruise ships.

1. You may not approach within 100 yards of any U.S. naval vessel, oil tanker, or cruise ship. When this is impossible to avoid, you must contact either the vessel or the Coast Guard escort vessel on channel 16 of the VHF radio.
2. Also, you must operate at minimum speed within 500 yards of these vessels.



WARNING

Do not approach within 100 yards of any U.S. naval vessel. If you need to pass within 100 yards of a U.S. naval vessel in order to ensure a safe passage in accordance with the Navigation Rules, you must contact the U.S. naval vessel or the Coast Guard escort vessel on VHF-FM channel 16.



OPERATE AT MINIMUM SPEED

You must operate at minimum speed within 500 yards of any U.S. naval vessel and proceed as directed by the Commanding Officer or the official patrol.

Violations of the Naval Vessel Protection Zone are a felony offense, punishable by up to 6 years in prison and/or up to \$250,000 in fines

Rendering Assistance

The operator of a vessel is obligated by law to provide assistance that can be provided safely to any individuals in a dangerous situation on the waterway. The operator is subject to fine and or imprisonment for failure to do so.



DANGER

AVOID BODILY INJURY OR DEATH FROM FALLING OVERBOARD! ALL OCCUPANTS SHALL STAY SEATED IN THE COCKPIT WHILE THE BOAT IS RUNNING.

Water Sports

Besides learning the safety precautions for safe boating, as well as understanding and knowing required rules and regulations, you are obligated to be particularly careful around other water sportsman, such as scuba divers, water skiers, wake boarders, and fisherman.

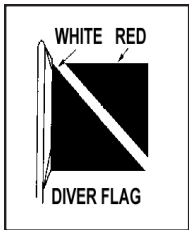

Whenever you see a “Diver Down” flag, maintain a distance of at least 100 feet on inland waters. In bays and open waters stay 300 feet away. The flag indicates a diver in

the water. If a diver is operating from your boat, be certain to use this flag and post a lookout on board to observe the diver’s air bubbles.

Swim Platform:

On all types of swim platforms you should make periodic inspections of the swim ladder and hardware that support the platform to ensure that all connections and fittings are tight and in good condition. Always insert ladder and install the cover before making headway!

Use heed when operating the boat in reverse to insure that water does not accumulate excessively on the platform or transom, especially in rough seas or strong currents. If installed, do not exceed the recommended maximum capacity label!

Typical label shown (vary by platform type/model).



WARNING

AVOID SERIOUS INJURY OR DEATH!
DO NOT OPERATE THE BOAT
WITH PEOPLE IN THE WATER
ON TOP OR HOLDING ON TO
THE SWIM PLATFORM STRUCTURE.

Read and understand the warning label above regarding “teak surfing.”

Fishing

Most boaters fish from time to time. With the propulsion systems of today it is possible to fish in out-of-the-way places. When cruising, stay clear of fisherman. They may have lines or nets out which might be cut or get caught in your propeller if you come too close. Slow down when approaching fishing boats. Do not return to cruising speed until the boats have been passed. If a fishing boat should be anchored, a large wake could flip or swamp the boat, upset fishing gear, pull the anchor loose from the bottom or worse yet cause someone to fall overboard.

When fishing from your boat, never anchor in a shipping channel or tie up to any navigational aid. These must be kept clear of at all times. Be sure to carry a local chart of the area to back up your plotter and be on the lookout for shallow water and hidden obstructions. Many times local conditions change and there is a time lag on the plotter chip until the next revision. Pick up a tidal chart if appropriate so you do not end up grounded.

Weather / Water Conditions

Before a boating outing check the weather conditions. As we all know the weather can change rapidly in many parts of the country. It does so sometimes without being predicted. NOAA weather radio reports are continuously available on designated frequencies installed on VHF radios and various hand held devices.

Also, many local radio stations carry weather reports along with on-line information.

Cloud Formations:

Clouds indicate the type of current weather and upcoming changes in the weather. Knowing the type of cloud formation can assist you in understanding current weather. Flat clouds (stratus) normally indicate stable air. Cumulus clouds indicate unstable air.

Many times a “cotton ball” or cumulus cloud builds vertical height in the afternoon and the result is a thunderstorm with increased winds and waves; sometimes these storms are quite violent.

Also, water spouts with high vortex winds can develop over water. You can find additional weather information (meteorology) at your local library or on the internet.

Waves & Fog:

As the wind blows across water waves are created. The stronger the wind and increased distance across the water enlarges the wave action. Other factors that can cause problem situations for vessels are fog, currents, and tidal changes.

Fog can develop inland on clear, calm mornings. Coastal areas see large “blankets” of fog roll in and stay for extended time periods sometimes causing hazardous navigation conditions. If you are caught in the fog, do not panic. Think of the best plan of action and proceed carefully. If you are limited in navigation equipment at the first sign of fog proceed to the nearest shoreline and wait until the fog lifts.

Boats equipped with navigation equipment, local waterway experience and charts should proceed to a safe harbor. Use extreme caution, signal as needed, and reduce to a speed where you can stop within half of your forward vision range.

If foul weather catches you at sea do the following:

1. Slow down. Proceed with caution and put on your life vests.
2. Try to reach the nearest safe shoreline.
3. Navigate your vessel slowly into the waves at a 45 degree angle.
4. Passengers should sit low in the center of the vessel.
5. Monitor your bilge pump. Make sure sump stays free of water.
6. Secure loose gear. Make ready emergency equipment.
7. Anchor over the bow but never over the stern.

Chapter 3

Rules Of The Road

Navigation Rules Defined

The Navigation Rules set forth actions to be followed by boats to avoid collision. They are referred to as the “Rules of the Road”. There are two main parts referred to as the inland and international rules. The inland rules apply to vessels operating inside the boundaries of the United States. The international rules (referred to as 72 COLREGS) apply to vessels operating on the high seas and all connected waters outside the established demarcation boundaries. Most navigational charts show the demarcation lines by red dotted lines and are published in the navigation rules. Remember to consult state and local agencies since areas such as “no wake zones,” swimming beaches, “diver down flag” and inland landlocked lakes fall under their responsibilities. This section is only an introduction to the “rules of the road”. We strongly recommend additional training before getting behind the “wheel”.

Order Inland & International Navigation Rules from:

Superintendent of Documents
U. S. Government Printing Office
Washington, DC 20402
Tel: (202-512-1800) Fax:(202-512-2250



Navigation Rules

Right Of Way:

1. Cross waves at right angles.
2. When caught in heavy water or squalls, head either directly into the waves or at a slight angle. Reduce speed, but maintain enough power to maneuver your boat safely.
3. Keep your speed under control. Respect the rights of other boaters engaged in all water sports. Give them plenty of operating room.
4. Whenever meeting a boat head on, keep to the right where possible.
5. When two boats cross, the boat to the right (starboard) has the right of way.
6. When overtaking or passing, the boat being passed has the right of way.
7. In general, boats with less maneuverability have right-of-way over more agile craft. The skipper must keep his craft clear of the following vessels:
8. A vessel not under command or aground; due to their circumstances, these vessels have no maneuverability.

9. A vessel restricted in its maneuverability; these vessels usually are performing work which limits their maneuverability. Examples are boats surveying, dredging, laying pipe or cable, or servicing navigational markers.
10. A vessel engaged in fishing; these include boats fishing with lines, trawls or nets, but not trolling lines.
11. Sailboats; they have the right-of-way over powerboats. However, if a sailboat is using a prop to move forward, it is considered a powerboat even if the sails are up.
12. Remember the unwritten "rule of tonnage". Basically a smaller tonnage vessel should take every effort to avoid close quarters with a larger tonnage vessel. One way to accomplish this is to have a designated human lookout to "eyeball" the horizon for any developing collision course.
13. Use defensive driving skills on the waterway just as you do on the roadway. The other vessel may not know the rules of the road. Be alert and ready to take immediate action.
14. If a collision course is unavoidable neither boat has the right of way. Both boats must react to avoid an accident according to the rules of the road.

Lookouts:

International and Inland navigation rules spell out the specifics of establishing a lookout. A lookout is legally defined by the court system as a person who has specifically charged duties on board such as observing sounds, echoes, lights and any inhibitors to navigation with complete thoroughness as permitted by the circumstances.

The term "specifically charged" means that the lookout has no other duties at that time that could prevent him from keeping a proper watch.

Of course the skipper must delegate the lookout duties to a seasoned crew member who can react to events quickly and communicate effectively with the captain with little notice.

As captain of your yacht you are responsible for the vessel and the crew. Choose an experienced individual as lookout and review the navigation rules with this person so he can make the right call quickly as situations develop.

WHISTLE SIGNALS

ONE LONG BLAST: Warning signal
(Coming out of slip)

ONE SHORT BLAST: Pass on my port side

TWO SHORT BLASTS: Pass on my starboard side

THREE SHORT BLASTS: Engine(s) in reverse

FOUR OR MORE BLASTS: Danger signal

BRIDGE SIGNALS

		DAY (Flag)	NIGHT (Lights)
SOUND	VISUAL		
VESSEL: Open	—●	↑	↑
BRIDGE: OK	—●	↓	↓
No	●●●●●	Same	Same
VESSEL: Replies:	●●●●●	or	or
RADIO: VHF CH. 13		No	No

Navigation Rules

The Navigation Rules set forth 3 types of crossing situations- crossing, meeting, and overtaking. In each case, both boats are governed by special procedures.

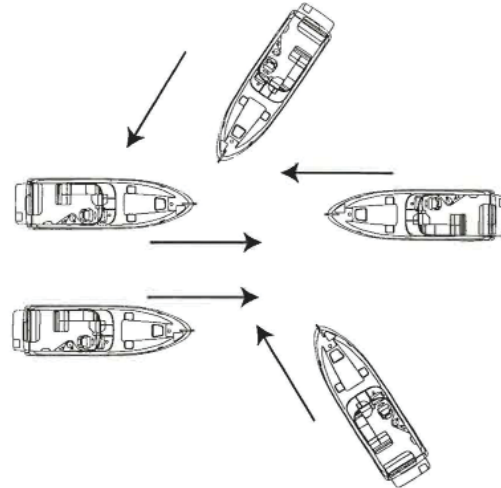

In a head-on meeting, both vessels must sound a single blast to give way toward starboard and pass to port.

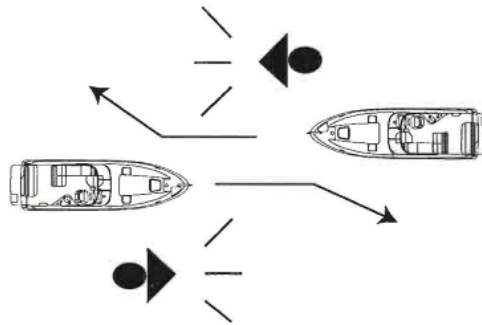

These rules appear when there is a risk of collision. In a crossing situation be aware of the other craft's position. For safety, there should be a noticeable change in the angle, bow or stern; a gradual change in position indicates possible danger.

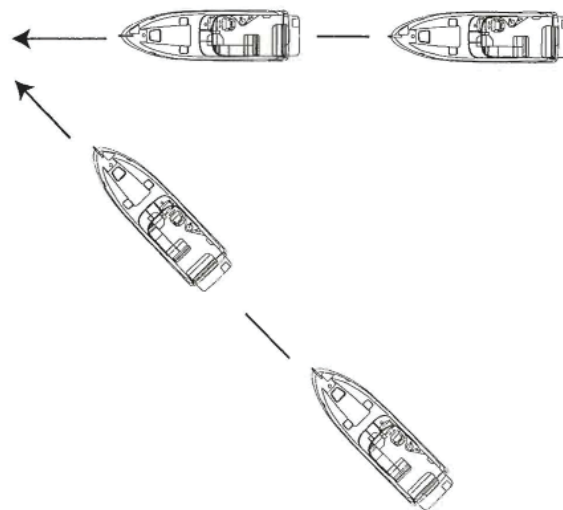

Navigation Rules

An overtaking boat is burdened, and is not the privileged craft, even though it approaches the danger zone of the overtaken boat.

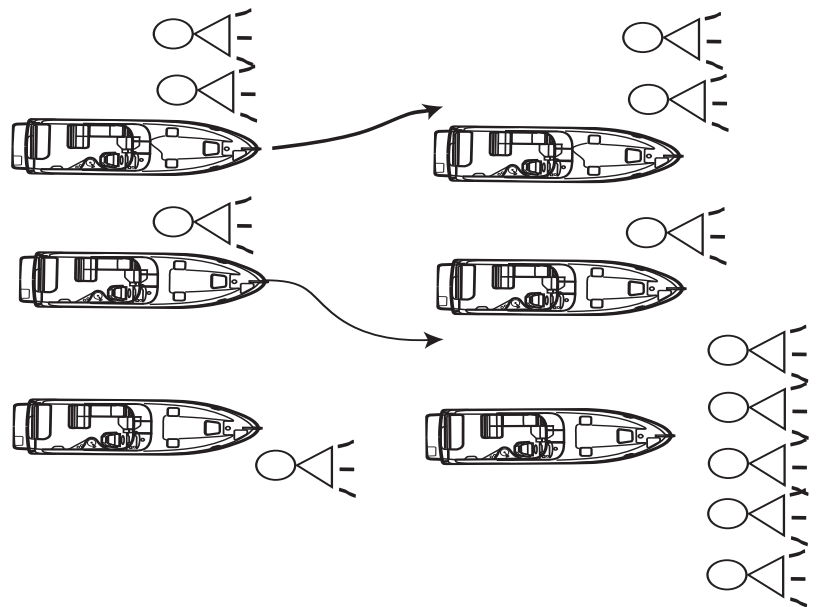
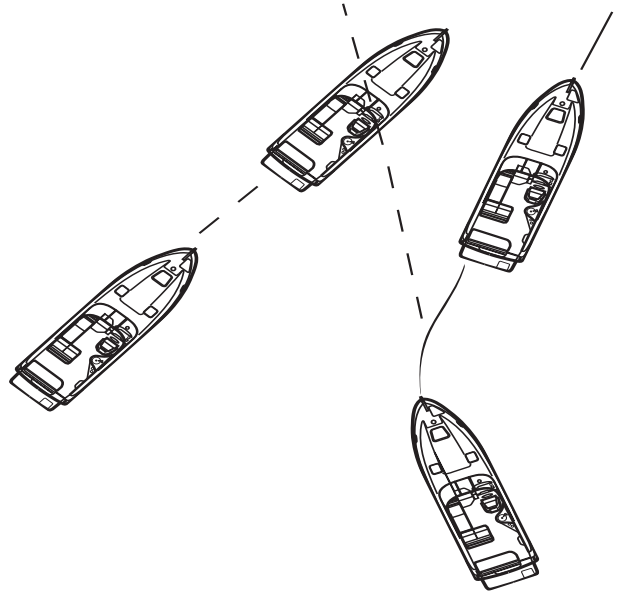

The overtaking boat first signals with a single blast if that boat desires to pass on the starboard side of the boat ahead, or a double blast if passing to port. The overtaken craft responds with the same signal if safe, or with the danger signal (5 short blasts or more) if unsafe. The boat overtaking must not pass unless the appropriate signals are sounded.

Navigation Aids

Navigation aids are placed along coasts and navigable waters as a guide for mariners in determining their position in reference to land and hidden danger. Each aid provides specific information. They form a continuous system of charted markers for monitoring on the plotter or providing accurate piloting on paper as a backup. Your on board plotter provides up to date navigation aids. Besides coastal maps a complete domestic interior waterway grid is featured on the plotter.

If desired, there are hand-held GPS devices that are available as back-up devices. In addition, nautical charts are provided by the National Ocean Service (NOS) and are distributed nationwide through marinas and outlet stores. These charts show the geography of the coast, water depth, landmarks, navigation aids (buoys and markers), marine hazards, and port facilities. Use only up-to-date charts for navigation. We recommend when purchasing a chart to look for the weather resistant ones. Buoys provide a road map to keep the skipper on course and to avoid hazards. Buoys are identified by light, shape, color and in severe weather conditions by sound.

Buoys or beacons called lateral markers indicate the port and starboard sides of the waterway to be followed. U. S markers follow the buoy age system known as Red Right Returning. When returning from sea or traveling upstream, the green markers are to port (on your left) and the red markers are to the starboard side (on your right). When traveling downstream or out to sea the marker color would be reversed.

Before operating your vessel, learn to identify the various navigational aids such as lateral aids, mid-channel markers, information and regulatory markers.

NOTICE

SKIPPERS MUST NOT RELY ON BUOYS ALONE TO MARK THEIR POSITION. SEVERE WEATHER CONDITIONS AND WAVE ACTION CAN ALTER A BUOYS POSITION. NEVER TIE UP TO A BUOY. IT IS ILLEGAL AND DANGEROUS.

Lateral Aids

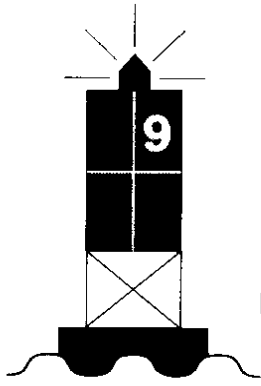

G "9"
FI G 4 sec

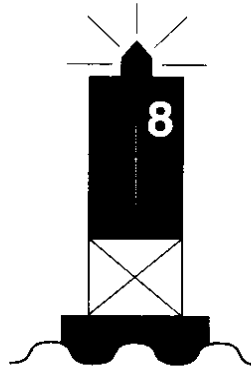

R "8"
FI R 4 sec

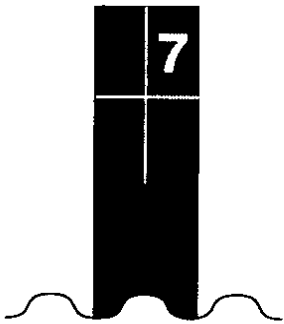

C "7"

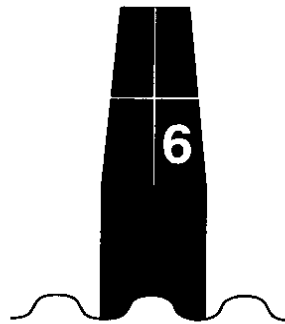

N "6"



G "1"

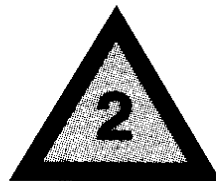

R "2"

Mid-Channel Markers

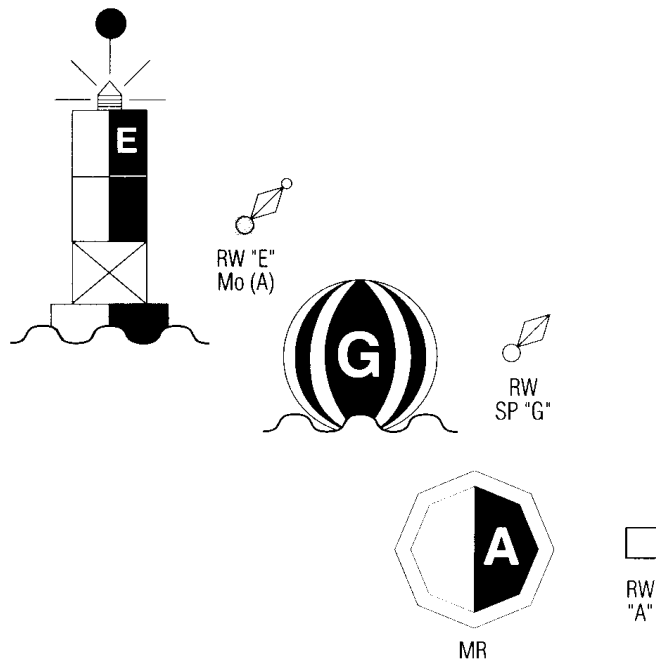

Regulatory Markers

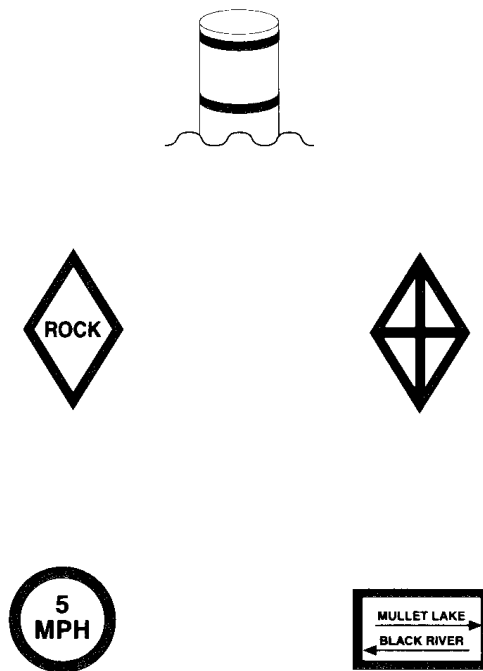

Night Running

Boats operating between sunset and sunrise (hours vary by state), or in conditions of reduced visibility, must use navigation lights. Night time operation, especially during bad weather and fog, can be dangerous. All Rules of the Road apply at night, but it is best to slow down and stay clear of all boats regardless of who has the right-of-way.

To see more easily at night, avoid bright lights when possible. Also, it is helpful to have a passenger (appoint as lookout) keep watch for other boats, water hazards and navigational aids.

To determine the size, speed and direction of other vessels at night, you should use the running lights. A green light indicates starboard side, and a red light indicates port side. Generally, if you see a green light, you have the right-of-way. If you see a red light, give way to the other vessel.

Bridge Clearance

Be aware that your vessel requires a specified bridge clearance height. This height is a measured

estimate from the waterline to the top of the highest equipment height. The estimated height can change because of variances in the loaded condition of the vessel and equipment variances. Consult the bridge clearance specifications located in Chapter 12 (Technical Information section). Some bridges are tendered. Know and use the proper bridge signals when approaching these bridges (see bridge signals in this chapter). You can also monitor and communicate on channel 13 of a VHF radio for bridge information in most domestic locals. Other bridges are marked with a clearance measurement and you are on your own. It is recommended that you have a look out posted for additional visual assistance when entering a bridge zone.

After determining your vessel will clear the bridge proceed with caution at a safe idle speed. Keep your eye on vessel traffic at all times in order to react quickly. Keep both hands on the helm since you may need to change course because of current and wind conditions. Resume a safe speed once clear of the bridge structure and acknowledgment of clear visibility. Just use common sense around any type of bridge structure!

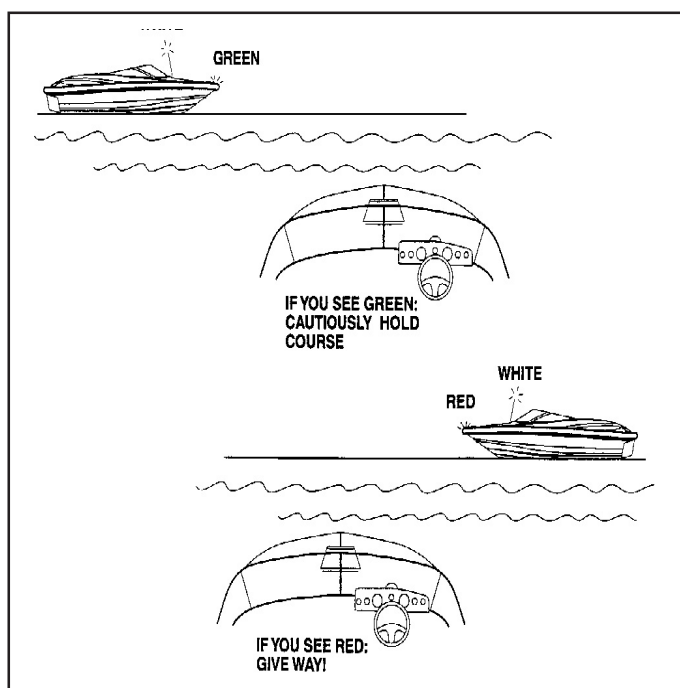

Bridge Lighting:

Bridge lighting is maintained by the Department of Homeland Security. On the following pages are 2 typical examples of night-time bridge lighting. As the skipper approaches bascule and fixed bridges light position (arc of visibility) and color will indicate the safe channel through the bridge. Notice green denotes the "safe" entry location on single-span bridges and green or white on multiple-span bridges designates the main channel. In addition, green denotes the "up" position for single and double lift bridges.

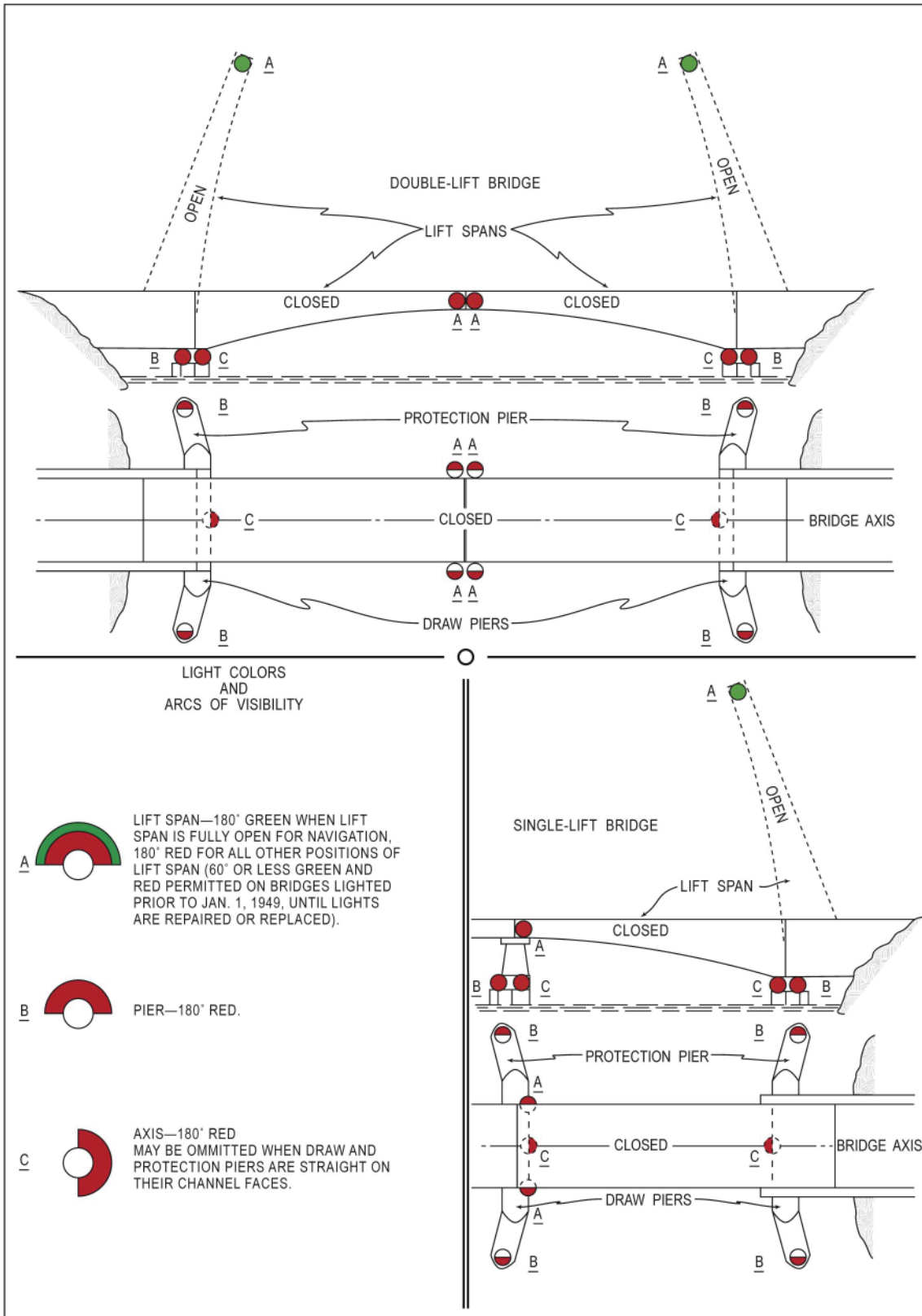

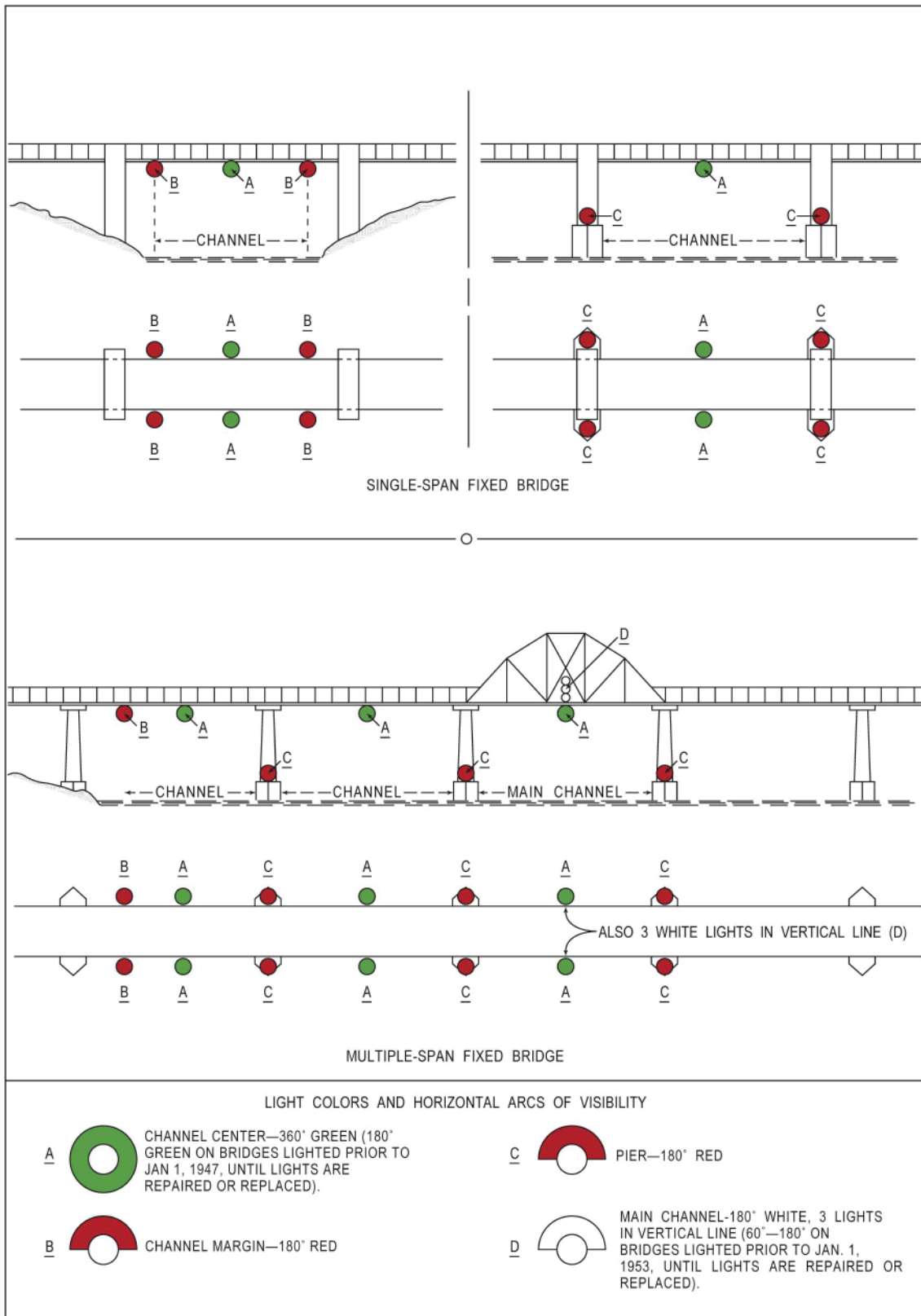

Chapter 4

Systems

Overview

In this chapter Regal on board systems are introduced. Information includes several main systems including fire protection, fuel, electrical, water, waste, electronics, entertainment and trim tabs. In short, this chapter is the “meat and potato” section for systems.

A system description, location of components, and operational information is found in this section. Enhanced vendor component details and troubleshooting can be found in the owner’s information packet along with the troubleshooting chapter of this manual.

Be sure to read and follow any danger, warning, or caution labels in reference to boat systems or individual equipment components.

Note that your Regal boat may not contain all of the equipment or systems shown. Regal has the right to modify, update or delete equipment and/or systems at anytime. Refer to the vendor documentation located in the owner’s information packet for more detailed information of individual system components and/or the chapter on equipment operation.

 **WARNING**

PREVENT INJURY OR DEATH!
READ AND UNDERSTAND THE
PROPULSION AND GENERATOR OWNER'S
MANUAL BEFORE ATTEMPTING
TO OPERATE THE VESSEL.

Fire Protection

Automatic Fire Extinguishing System



Vessels with generators use both a powered ventilation (blower) system and a fire extinguishing system in the sump capable of automatic and manual activation. The dash monitor utilizes an instrument display unit light that provides the operator with a system status of a charged or uncharged condition by an audible alarm and icons. With the ignition switch on and a no light condition it indicates that the system has



been discharged.

If the fire extinguishing system should discharge the ignition system will be instantaneously interrupted and the engines will shut down. See the automatic fire extinguisher manual in the owner’s packet for additional details.



If a fire has started in the engine compartment the system will automatically discharge or the operator can manually discharge the extinguisher. Find the system manual cable assembly located in the cockpit. To use the manual remote remove the safety pin from the

“Fire T Handle” and pull firmly on the “Fire” handle which will activate the fire extinguisher unit in the engine compartment. A loud “rushing air” sound may be heard. Complete discharge will take several seconds. Keep the compartment closed for a period of time sufficient to permit the agent to soak all areas of the protected space. This allows hot metals and fuel time to cool. Refer to the automatic fire extinguisher owner’s manual for additional information.

Note: The boat operator needs to educate the crew on fire protection and more specifically the automatic fire extinguishing system in the event that he becomes incapacitated. It is a good idea to practice by having a mock fire drill.

Portable Fire Extinguishers

Clean agent extinguishers are primarily for Class B and C fires (gasoline is a flammable liquid under the Class B group). The extinguisher should be of the 5 lb. capacity and 2 are recommended based on the maximum capacity of the fuel tank onboard and the boat length. These extinguishers may be available from your dealer, marine speciality stores, or on the internet. It is recommended to have extra portable fire extinguishers to backup the automatic fire extinguisher system since a fire could take place in an area outside of the sump/machinery space.

As noted above a clean agent type of liquefied gas used today is FE-241. This gas is colorless and odorless, heavier than air and sinks to the lower parts of the sump to extinguish fires. Since the year 2000 ingredients have changed to a more environmental friendly formula (Chlorotetrafluoroethane or FE-241). FE-241 is used in portable-hand units.

The canister needs to be weighed once a year. Also, the canister is engraved with a date which is part of the canister life cycle. Refer to the information regarding fire prevention in this manual and on the internet. Normally the clean agent fire extinguishers cost more than powdered or CO₂ extinguishers.

Electrical System

Overview

In this section, basic DC (direct current) and AC (alternating current) electrical systems are introduced. Select electrical components are reviewed along with their location and function within the electrical system.

For more complicated issues outside the scope of this manual contact your closet Regal dealer. They have undergone extensive training on the Regal boat systems.

Be sure to read and follow any danger, warning, caution, or notice labels in reference to the vessel's electrical system or individual equipment components. Also, refer to the owner's information packet for further product information or the internet.

 **WARNING**

PREVENT SEVERE INJURY OR DEATH!
DISCONNECT
ALL ELECTRICAL POWER SOURCES
BEFORE ATTEMPTING
TO REPAIR OR REPLACE
ANY ELECTRICAL COMPONENT.

 **CAUTION**

AVOID CHARGING SYSTEM DAMAGE!
DO NOT TURN ENGINE OR HOUSE
BATTERY SWITCHES TO THE "OFF"
POSITION WITH THE ENGINES RUNNING.

DC Current

Your Regal boat uses 12 volt DC electricity otherwise known as direct current. It is called DC because it flows only one way in a circuit. Specifically to name a few, helm gauges, batteries, battery cables, engine electrical components, engine wiring harnesses, dash switches, selected lighting, shower sump, bilge pumps, and vacuum toilets are all components using a 12 volt DC system.

In the domestic DC system the red wire is designated as the "hot" or conductor wire and the black wire is referred to as the ground wire. At times other current carrying wires are color coded such as blue to identify their use as a low voltage conductor. This is especially helpful in troubleshooting and adding additional equipment. Be sure to review the wiring schematics in the drawing section of the technical chapter.

Direct current is stored in the ship's batteries and produced through the engine stators while the engines are running or by the battery charger at dockside. The outboard stators charge the batteries by sending current through the main distribution panel relays, battery switches and harnesses to the appropriate battery. Normal DC voltage is between 12 and 15 volts. Lower or higher readings could indicate a charging malfunction or a weak battery.

Note that current specifications for alternator output is 50 amps for 350 hp outboard and 70 amps for the 300 hp outboard. The port engine battery controls the port engine and forward bilge pump. The starboard engine battery controls the starboard engine and high water alarm. The house batteries control a variety of onboard components and accessories.

TYPICAL DC (12 VOLT) WIRING COLOR CODE & SIZES		
BLACK	16,14,12,10,8,6,4,2,2/0,40	GROUNDS
BLACK/WHITE	16	HALON INDICATOR
BLACK/YELLOW	10,16	GRD. DIESEL TRANSFER PUMP, MERC DIESEL STOP CIRCUIT
BLACK/WHITE	10	HALON MAIN GRD. FEED
BROWN/BLACK	10	MACERATOR, SUN ROOF
BROWN	10	SUN ROOF
BROWN	14	AFT BILGE PUMP-MANUAL
BROWN/WHITE	14	AFT BILGE PUMP-AUTO
BROWN/RED	14	FWD. BILGE PUMP-AUTO
BROWN/BLUE	14	FWD. BILGE PUMP-MANUAL
BROWN/PINK	16	CO DETECTOR
BROWN/BLACK	16	SHOWER SUMP PUMP
YELLOW	12,10	BLOWER
YELLOW/WHITE	16	HEAD VENT FAN MOTOR
YELLOW/BLACK	16	STEREO MEMORY
YELLOW/RED	14	ENGINE START CIRCUIT

Note: The list above applies to a number of vessels. Vessel components/wiring specifications may vary depending on the model.

TYPICAL DC (12 VOLT) WIRING COLOR CODE & SIZES (CONTINUED)		
ORANGE	10,12	VACUUM TOILET, REFRIGERATOR, HATCH RAM
ORANGE	16	WIPER RUN
ORANGE/WHITE	16	WIPER PARK
ORANGE/BLACK	10,12,16	HORN, HATCH RAM
BLUE	14	INTERIOR LIGHTS, SWITCHED CIRCUIT
BLUE/RED	14	INTERIOR LIGHTS, CONSTANT HOT CIRCUIT
BLUE/BLACK	16	COCKPIT SOFT LIGHTS
BLUE/GREEN	16	INTERIOR SOFT LIGHTS
BLUE	10	CABIN LIGHT MAIN CIRCUIT FEED
GRAY	14	NAVIGATION LIGHTS, RUN- NING, BOW, TRANSOM LIGHTS
GRAY/BLACK	14	NAVIGATION LIGHTS, AFT AN- CHOR, MASTHEAD
GRAY/WHITE	14	NAVIGATION LIGHTS, MAST- HEAD, FWD. RUNNING LIGHTS
RED	16	POSITIVE FEED- ELECTRON- ICS, GAS VAPOR DETECTOR, BREAKER TO DASH SWITCH FEEDS

Note: The list above applies to a number of vessels. Vessel components/wiring may vary depending on the model.

TYPICAL DC (12 VOLT) WIRING COLOR CODE & SIZES (CONTINUED)		
RED/WHITE	16	WINDLASS CONTROL-DOWN
RED/BLACK	16	WINDLASS CONTROL-UP
RED/WHITE	14	BATTERY PARALLEL-LOAD
RED	14	POSITIVE FEED-ELECTRONICS
RED	12	POSITIVE FEED-ELECTRONICS
RED	10	POSITIVE FEED-AUTO PILOT
RED/VIOLET	10	FUEL TANK TRANSFER PUMP AMPLIFIER POWER
RED	8	POSITIVE FEED- MAIN ALTERNATOR CHARGE
RED	6	POSITIVE FEED- MAIN ALTERNATOR CHARGE
RED	4	POSITIVE FEED-MAIN
RED	2	POSITIVE FEED- MAIN STARTER, BATTERY, GENERATOR
RED	2/0	POSITIVE FEED- MAIN, START- ER, BATTERY
PURPLE	16	STBD. IGNITION, HOUR METER- WINDSHIELD VENT
PURPLE/WHITE	16	PORT IGNITION, HOUR METER, WINDSHIELD VENT
PINK	16	STBD. FUEL TANK SENDER
PINK/BLACK	16	PORT FUEL TANK SENDER
TAN/BLUE	16	ENGINE ALARM CIRCUIT
GREEN	16	TANK LEVEL MONITOR, SPOT- LIGHT
GREEN	10	SPOTLIGHT
GREEN	8	BONDING

Note: The list above applies to a number of vessels. Vessel components/wiring may vary depending on the model.

Batteries

All vessel DC equipment and specifications are subject to change at any time, as part of Regal's commitment to product improvement. Equipment shown here and information is up to date per the manual printing date.

NOTICE

NOTE THAT THE VESSEL USES A SEPARATE WIRE FROM ONE OUTBOARD STATOR TO CHARGE THE HOUSE BATTERIES AND ANOTHER DESIGNATED WIRE FROM THE OTHER OUTBOARD STATOR TO CHARGE THE ENGINE CRANKING BATTERIES.

Battery Terminology Descriptions

Group- Batteries are divided into groups which identify the height, length, and width of the battery. This is useful information should a replacement battery become necessary. Note that the 33 SAV currently uses 31 A series batteries.

Cold Cranking Amps (CCA)- This rating measures the cranking power of a full charged marine battery having the ability to start at 32 degrees F. Basically, the higher the rating the greater starting power of the battery.

Reserve Capacity (RC)- As usage on the boat increases so does the need for more reserve capacity. The reserve capacity represents the length of time in minutes a new fully charged battery can maintain the vessel's electrical needs without the engine running or in the event the stator failure.

BATTERY SPECIFICATIONS			
Battery Type	Group	CCA @32 Degrees F.	Reserve Capacity
Engine Cranking & House	31 A	1260	195 min.

ENGINE CRANKING BATTERY LOCATIONS STB. SUMP

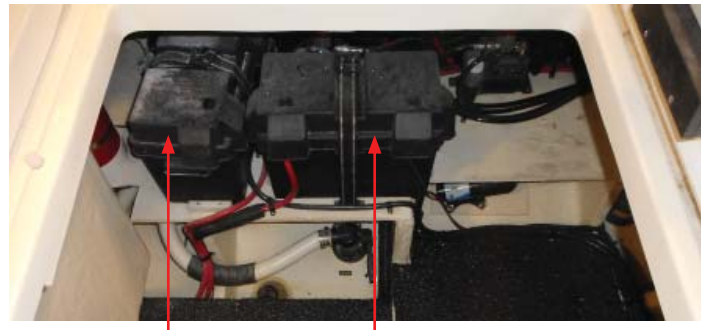

STARBOARD ENGINE

PORT ENGINE

HOUSE BATTERY LOCATIONS PORT SUMP



HOUSE BATTERY

HOUSE BATTERY

Battery Problems/Solutions



1. Weak battery- This battery problem can be caused by low electrolyte cell levels.

Warm, bilge compartment temperatures will deteriorate a battery's life quicker by evaporating the water from the electrolyte, thus corroding and weakening the positive grids inside the battery.

With the house battery low electrolyte levels can be monitored by periodic inspection and filling as needed with distilled water. Boaters in higher climate areas with longer stretches of hot weather will need to check their batteries more often.

The "maintenance free" engine cranking batteries require no water. They do feature a different chemistry that does consume less water. Inside the cells as gases are released condensation is formed which aids in maintaining the cell electrolyte level. These batteries incorporate a deeper layer of electrolyte over the plates, but eventually it can run dry. On the 31 series engine cranking batteries keep all terminals clean, connections tight and your electrical system in top shape to extend battery life.

2. Dead Battery- Either the battery will not accept a charge, hold a charge or the charging system is not supplying a charging current through the battery charging system and/or engine stators.

The battery charger output can be checked by monitoring the lights on the charger front face.

To begin with check the battery post connections for tightness and corrosion.

With the engines running the displayed voltage of the port or starboard engine battery and house battery should be between 12.5 up to 14.6 volts.

If less than 12 volts check for voltage across the battery terminals.

If less than 12 volts on the house battery use a hydrometer to locate faulty cells.

On maintenance free batteries they can be removed from the vessel if necessary and trickle charged. If readings after charging are still low replace the battery.

Battery Switch Panel



The house and engine cranking battery switches are located in the bottom locker at the port side of the helm. The port switch controls power to both engine cranking batteries. This battery switch shows an off, on, and combine

batteries position (yellow printed label).

In the on position both batteries feed individual port and starboard engine starting circuits. Remember that each engine cranking battery is being charged by its own separate stator wire. The engine battery switches on the panel are protected by individual breakers. Be sure to turn the battery switch to the off position when leaving the vessel.

When the engine battery switch is turned to the combine batteries position additional amperage is available to start either engine when one of the batteries has a low or no charge condition. There are 2 house batteries with their positives connected for parallel usage. This setup normally doubles available amperage and retains battery voltage.

The house batteries feature a split charging circuit wire developed by the outboard manufacturer. This permits each house battery to be charged by an individual outboard stator. When leaving the vessel it is a good idea to turn off the house battery switch. Notice the house battery switch is protected by a house battery breaker.

The dash main breaker at 70 amps protects the DC helm circuitry. If the breaker trips find the cause of the problem and repair it before attempting to reset the breaker. To reset the main dash breaker push the lever to the left (upward) until you hear it click which means it is reset.

BKRS. PROTECT ENGINE BATTERIES & HOUSE BATTERY SWITCHES



Battery Management System Panels



Located in the sump hull side accessible through the cockpit Lazarette storage locker is a long panel with the main battery management components. The main components are called out here along with the basic function of each.

Note that the main battery management system panel will be further discussed on another page to assist the operator on the equipment behind the cover.

The description and function are as follows:

1. The 60 amp breaker protects the **port** Optimus Electronic Power Steering system circuit including the pump and circuit wiring. The system is located on a panel board in the starboard sump (bilge).

2. The 60 amp breaker protects the **starboard** Optimus Electronic Power Steering system circuit including the pump and circuit wiring. The system is located on a panel board in the starboard sump (bilge).

3. This ground block serves as a home for the various 12 volt DC wiring grounds (color coded black).

4. This is the ship's battery charger which operates on dock side power or by running the generator.

5. These are the battery charger output wires (3) that travel to the starboard stud side of the battery management system panel. Charger output is 40 amps.

6. At the center of the battery management system is a 90 amp breaker. It protects the windlass wiring circuitry.

7. The battery management system panel is a key player in DC circuitry protection. Inside the panel is a number of system fuses. Also, the starboard side of the panel displays a row of studs which serve as individual circuit junction points. We will take a closer look at this panel on the following pages.

Battery Management System Panels (continued)

8. This breaker protects the auxiliary charging circuit wiring from the **port** outboard when the engine is not charging since it is part of the house load circuit connected to the house battery.

9. This breaker protects the auxiliary charging circuit wiring from the **starboard** outboard when the engine is not charging since it is part of the house load circuit connected to the house battery.

10. The remote battery switch supplies current to the 2 house batteries.

11. The remote house battery circuit is protected by a 50 amp cube fuse. Refer to the following pages for further operational information regarding the remote battery switch.

12. The port and starboard engine cranking battery circuits are protected by individual 50 amp cube fuses.

Battery Management System Panels (continued)

As part of the battery management system the house remote battery switch is located on the battery management panel board. When energized the on-off house battery switch provides current to the remote battery switch. The purpose of the remote battery switch is to break up the long battery cable runs.

The remote battery switch provides a continuous rating of 300 amps DC and a cranking rating of 1250 amps DC.

Bow Thruster Panel (Optional)

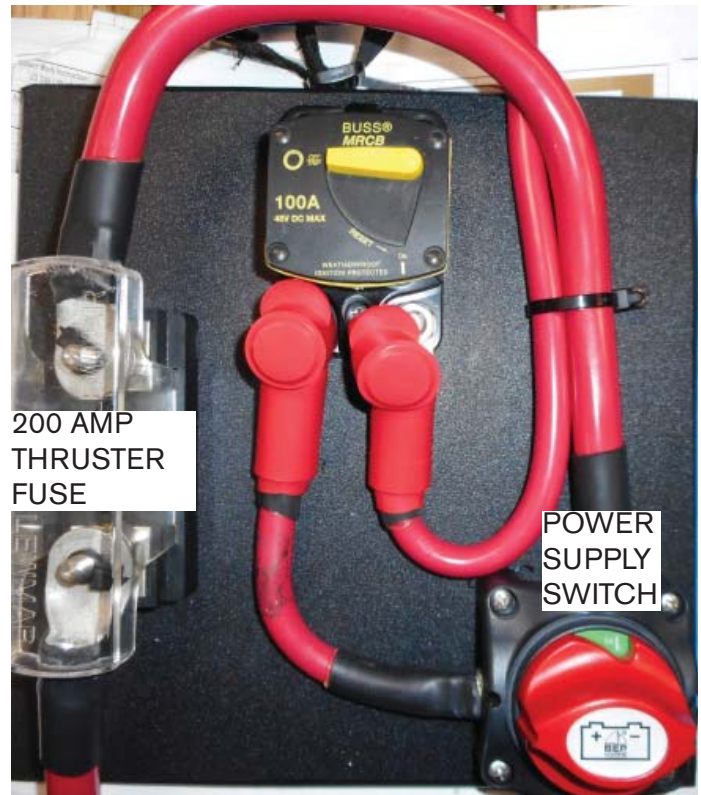

The optional bow thruster uses a 200 amp fuse between the thruster battery switch and the thruster itself. It protects the circuitry from overloads. The 100 amp breaker above protects the house main battery circuitry. *Note thruster circuit power supply switch.*

Remote Battery Switch Operation

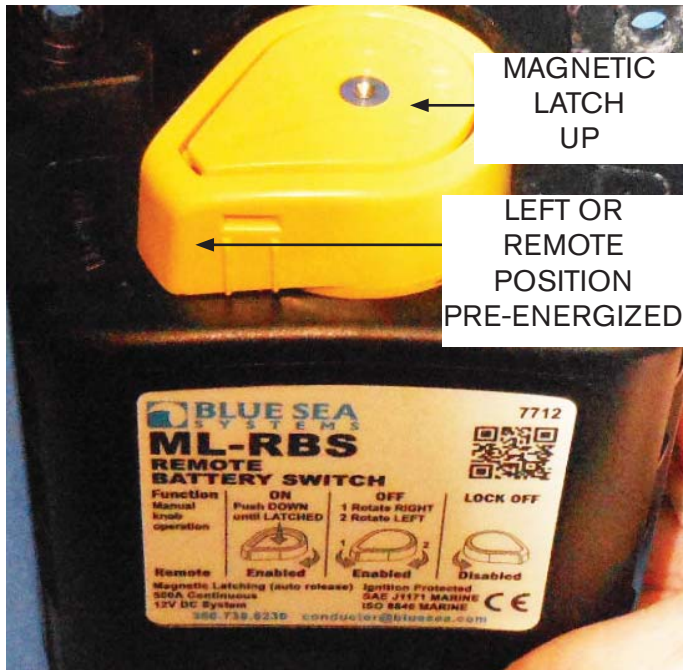

1. Normal operation of the remote battery switch is completely to the left in the auto or “remote” position. Notice latch position is up (manually disengaged). To energize the house circuit first flip on the house battery switch at the battery switch panel located at the port helm locker drawer. Once house battery is energized the magnetic latch will be pulled down in the energized position.

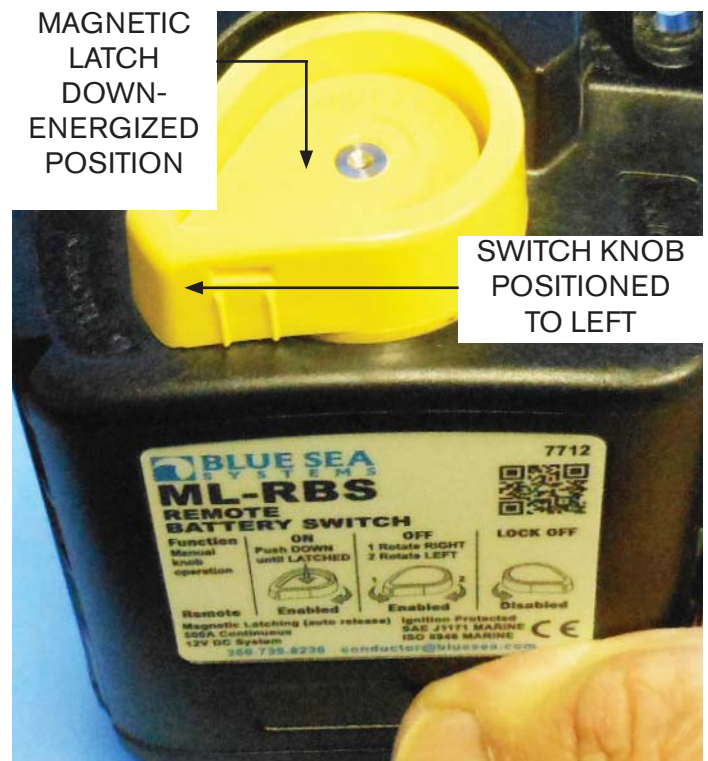

2. If the remote battery system fails for some reason the skipper can override the remote battery switch manually through the magnetic latch which is located on top of the switch. Just turn the switch to the left and push the magnetic latch down until it engages.

3. In the event of servicing the house battery components simply turn the remote battery switch to the right (Lock or Off Position). Pass a tie wrap through hole to secure the remote battery switch knob until servicing is complete.

Battery Management System Panel

Overview

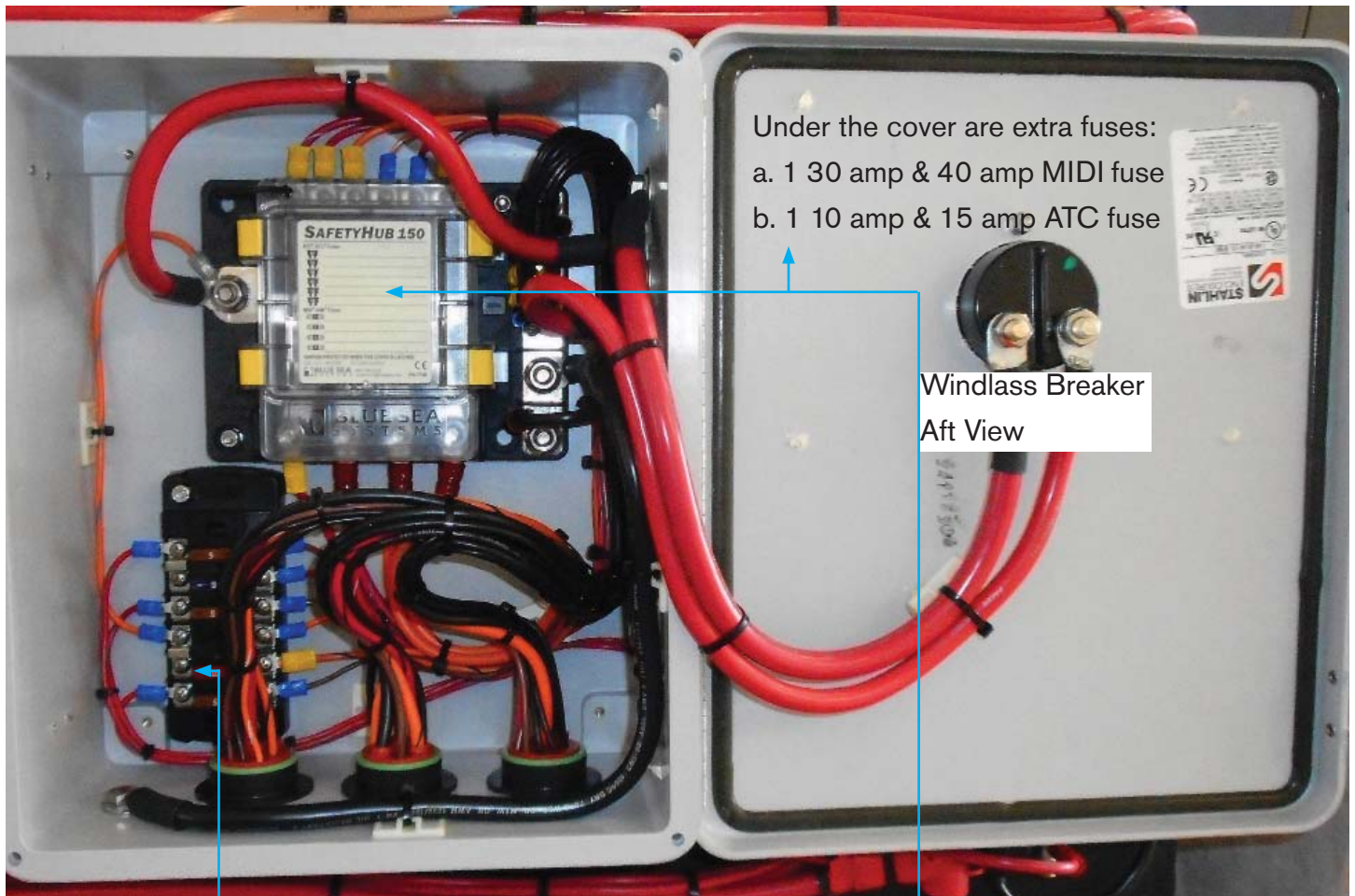

Under the cover are extra fuses:
 a. 1 30 amp & 40 amp MIDI fuse
 b. 1 10 amp & 15 amp ATC fuse

Windlass Breaker
 Aft View

Shown without clear enclosure
 cover

Circuit Name	Fuse Size	Position
Fwd Bilge Pump Automatic	5a	1
High Water Alarm	3a	2
Aft Bilge Pump Automatic	5a	3
Accessory	None	4
Fishbox Macerator	10a	5
Shower Pump	5a	6

Circuit Name	Fuse Size	Position
Sure Shade Main	15a	A
Sure Shade Memory	5a	B
Cockpit Refrigerator	15a	C
Level Monitor Panel	3a	D
Halon Relay	3a	E
Toilet Macerator	10a	F
Electric Head	30a	1
Cabin Main	30a	2
Amplifier	40a	3
Amplifier	40a	4

Battery Management System Panel (Continued)

The battery management panel serves as a junction and circuit protection component for much of the house equipment on the vessel. The box is fed using the dual house battery system.

The previous page displays the fuse covers along with fuse size, its position and the device each fuse protects.

The SAFETY HUB fuse block includes ignition protection which is a big plus when using gasoline engines on board.

The SAFETY HUB fuse block uses both MIDI and ATC fuses. These style fuses are used in the automotive industry.

MIDI fuses are used for system equipment components requiring high amperage including the toilet (head), cabin main, and 2 Fusion stereo amplifiers. The marine MIDI fuses feature the following:

1. Ignition protection within the SAFETY HUB 150 box.
2. Uses tin-coated copper blades for best conductivity and corrosion resistance.
3. Has a clear window for the fuse element to be seen easily. Helps in locating a “blown” fuse.
4. Specs for high amperage capacity which is great for many of the vessel DC devices.

ATC fuses feature the following:

1. They are fast acting so when activated will blow faster causing less damage to components.
2. Are used as standard protection in auto/truck industry.
3. Tin-plated blades for marine corrosion protection.

Note that the fuses mentioned are available at marinas, retail boating outlets, and your closest Regal dealer.

There is a fuse puller under the SAFETY HUB 150 fuse block cover. Remove the 4 tabs to access the fuse holder.

SAFETY HUB-CLOSE VIEW OF FUSES

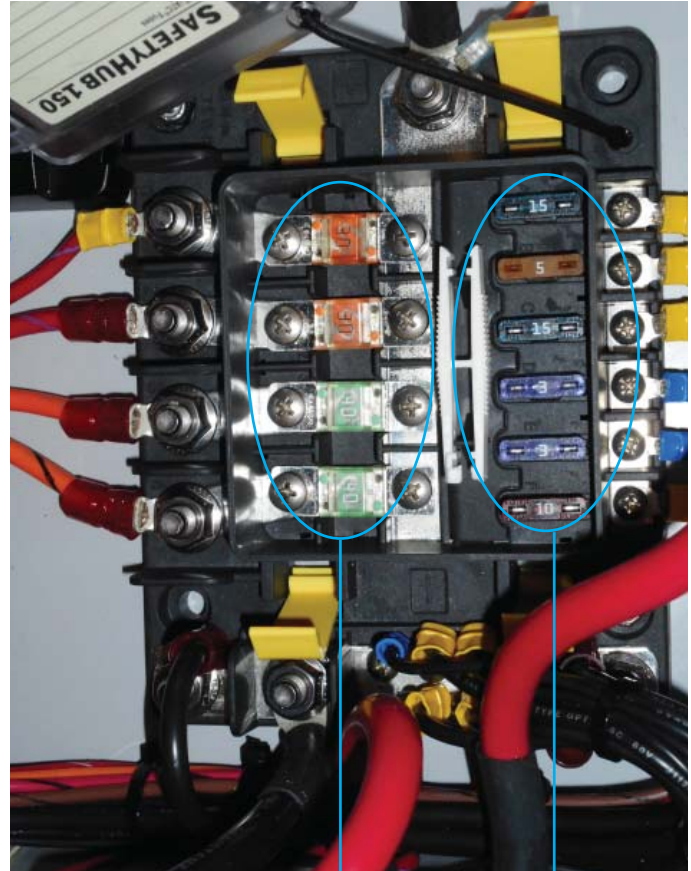

MIDI FUSES ATC FUSES

Note: See previous page for fuse description.

Auxiliary DC Breaker Panel

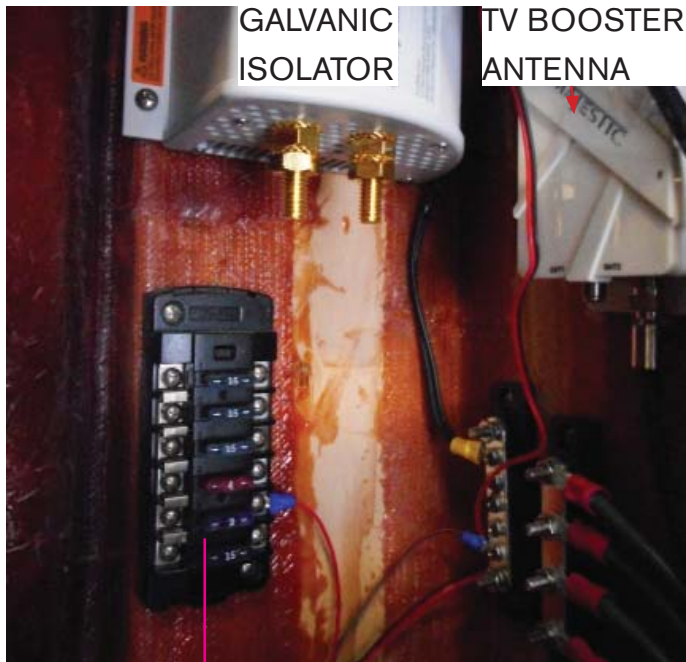

AUXILIARY DC PANEL

Inside the main ship's AC panel is a DC fuse panel with a plastic cover (shown above with protective cover off) that that protects select DC circuits.

To access the panel for service you will need to disconnect the dock side cord from the ships's AC power inlet plug. Read the warning label!

Next, take out the 6 phillips screws holding the AC ship's panel to the bulkhead. Carefully remove the panel. Now you will be able to access the ATC automotive style fuses.

The fuses are from top to bottom:

- 15 amp= overhead and front berth overhead lights
- 15 amp= head and mid berth overhead lights
- 15 amp= stereo
- 4 amp= head vent
- 3 amp= booster antenna
- 15 amp= front berth back rest/converts to sleeper



WARNING

PREVENT INJURY, DEATH, OR
FROM HIGH VOLTAGE!
DISCONNECT THE AC POWER SUPPLY
BEFORE ATTEMPTING TO BEGIN ANY SERVICE
WORK INSIDE THE MAIN AC SHIP'S PANEL.

Typical Battery Charger

The battery charger features 40 amp output and universal voltage for 2 battery circuits. The charger operates between 95 and 277 volts. This is helpful on docks that carry lower voltage. The new electronic battery chargers are “smart”. They will charge the batteries in 3 stages; bulk, absorption, and float formats. The charger is designated to get the maximum life out of your batteries, using micro computer controlled charging.

It is recommended to keep the battery charger “on” at all times when AC power is available for maximum battery life. We recommend checking the battery water level weekly.

Fill batteries to specified levels using only distilled water. The charger is factory set to charge flooded lead acid batteries which are the most common type available. The charger can be reprogrammed to take gel cell or AGM batteries.

In the event the boat is switched over to different battery designs, it is important that all batteries are of the same type.



Remember, changing to a different battery type requires re-programming the charger. Do not mix different designed batteries because they need different charging rates and voltages.

During bulk charge the battery charger brings up the battery charge state quickly, as the battery nears fully charged, it switches over to absorption charge. Absorption charges at a lower rate than bulk, until the battery is just a few % away from full charge.

The battery charger display includes functional LED information for charge current, charge voltage, charge phase (bulk, absorption, float), battery content measurement and/or battery condition measurement as a % of Ah capacity.

It is recommended that an ABYC certified electrical technician perform any repairs or service. Do not attempt to open the battery charger casing.

Refer to the vendor information for more detailed instructions.

 **WARNING**

PREVENT INJURY, DEATH, OR
PROPERTY DAMAGE FROM HIGH VOLTAGE!
DISCONNECT THE AC POWER SUPPLY
BEFORE ATTEMPTING TO BEGIN ANY BATTERY
CHARGER SERVICE WORK.

TYPICAL CHARGING SYSTEM- SUMMARY NOTES

Following are a few notes regarding the charging system or specific charging system components.

1. With the battery charger unplugged from shore power the battery charger is not generating any DC power. However, the battery charger is connected to the batteries through the battery switches and charger breakers which are located on the battery management panel. The charger breakers would stop any short in the wires that run directly to the battery charger. Remember that the charger is connected to the battery side of the switch and is continuously “hot”.

2. There is a breaker protecting the battery charger circuit. A primary cause of the breaker to “trip” would be if the positive and negative battery cables were crossed. The above situation could easily happen if someone was trying to start a battery with “jumper cables.” To a lesser degree should a wire delivering current from the battery charger chafe a fuse may “blow” and the battery charger would cease its charging operation. See your Regal dealer for ordering extra fuses for your charger.

3. If one of the engine cranking batteries is weak or “dead” and the engine will not crank first start the generator up and let it run awhile as it will send an initial charge to the weak battery.

Another option is to turn the engine battery switch to the notched area marked yellow or “combine both batteries”. Then crank the engine over.

4. Always turn the universal battery switches on the battery management panel to the “off” position when leaving the vessel for extended periods. Select breakers that control specific safety functions of the boat will operate as normal even with the battery switches off such as the automatic bilge pumps and stereo memory circuits.

5. When leaving the vessel after connecting your dock side power cord turn the battery charger breaker at the ship’s management panel to the “on” position. This will permit the battery charging system to energize the appropriate batteries as needed.

6. Remember the appropriate engine will not crank over with the universal battery switch in the “off” position.

7. An internal battery charger fuse protects the entire circuitry from reverse connections. For example, if someone was attempting to “jump” start an engine and had the polarity reversed on the jumper cables this action may cause the internal fuse to “blow” thus making the charger inoperative.

Bottom line- always remove a battery if using a trickle charger. It is not recommended to jump start engines using booster or jumper cables.

DC Junction Block

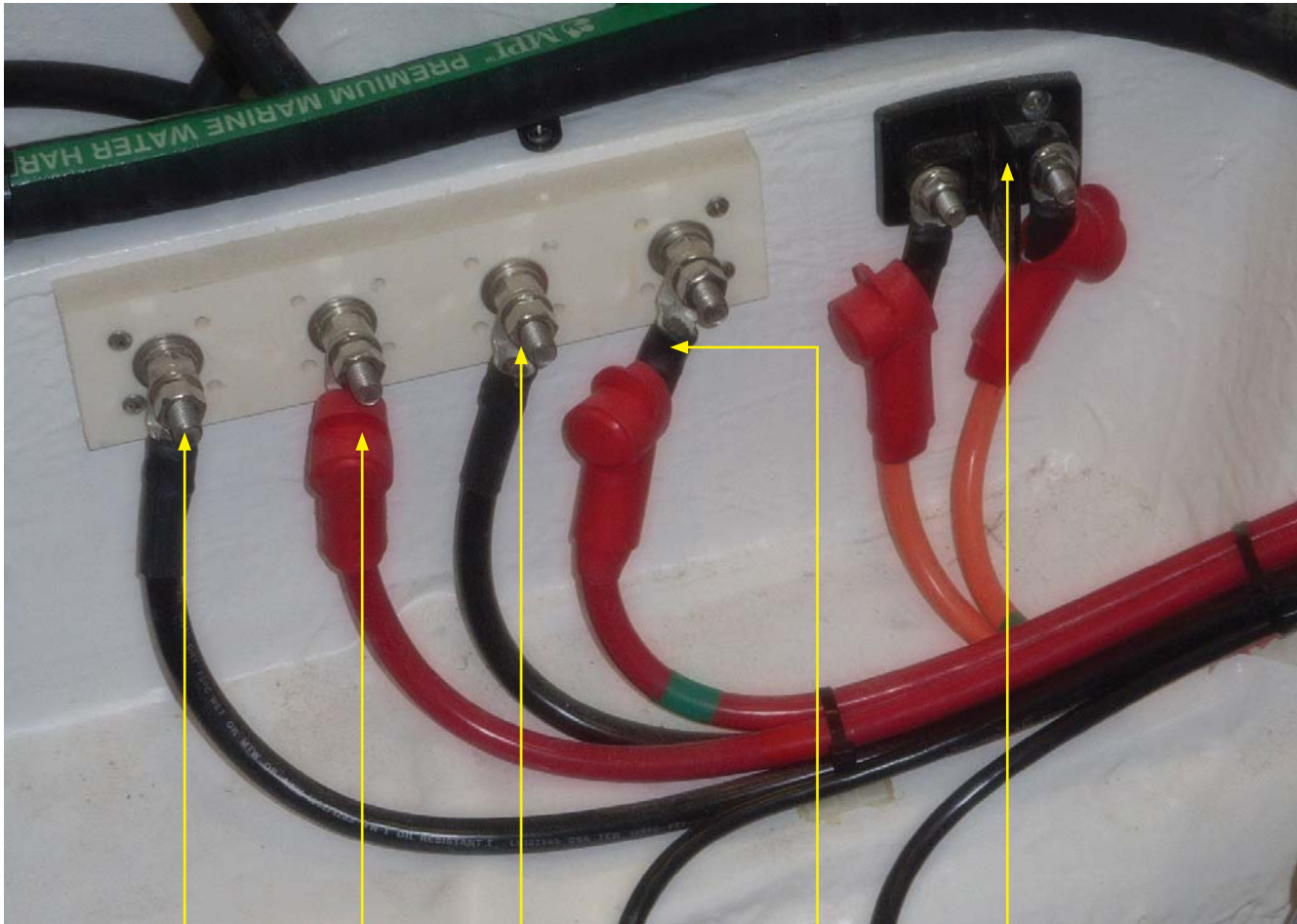

STARBOARD
ENGINE
BATTERY
NEGATIVE

STARBOARD
ENGINE
BATTERY
POSITIVE

PORT
ENGINE
BATTERY
NEGATIVE

PORT
ENGINE
BATTERY
POSITIVE

OUTBOARD
CHARGING
WIRES
POSITIVE

A junction is used as a common attachment point for the battery cables from the batteries (red and black cables shown) and the cables from the battery switches.

Also, 2 of the charging wires attach here and combine with the 2 wires running from each outboard charging circuit. Periodically check the fasteners for tightness.

AC Current

Overview

Alternating current sometimes called AC current is brought on board through the use of a dock-side (shore power) cord or produced on board through the generator. Just as a residential home uses 120/240 volts to run various household appliances and equipment the same holds true on your vessel.

With AC current electrons “cycle” in one direction a short distance and reverse themselves traveling in the opposite direction. This is how AC became known as alternating current. The rate that the current reverses itself is referred to as frequency. In the United States the alternating current frequency is 60 cycles per second. Overseas a 50 cycle frequency per second is standard. Component specifications must match the country's frequency.

Basic Electric Terms

Voltage is a measurement of the electrical potential that an electrical power source contains for doing some type of work for us. Think of it as electrical pressure. An example might be your boat's battery.

Amperage is a particular amount of electricity flowing through some part of a circuit. Think of it as the rate of electrical flow through your boat's wiring.

Resistance is measured in ohms and inhibits the electrical flow through a circuit. An example would possibly be an incandescent light bulb. The resistance in the light bulb element allows it to glow and brighten the cabin along with giving off heat.

It is important that you understand and respect the alternating current system used on board. Be sure to read and follow any danger, warning, or caution labels in reference to the yacht's electrical system or individual equipment components. Most of all, use common sense!

Dock side Cord Usage

The dock side cord is the basic component used to deliver dual 30 amp service from the marina dock power box to the vessel itself. Before plugging in the dock side power cord check to see that all vessel AC breakers are off. This includes the incoming as well as both the main and equipment breakers at the AC ship's control panel. See the AC panel illustration later in this chapter.

When connecting the shore power cord be sure to twist the cord into the marina inlet plug. This motion will lock the plug in the socket.

There may be several types of inlet plugs located at the marina dock power center. Be advised that the 30 amp plug is much smaller looking and the 50 amp cord will not physically fit it.

Also, marina dock power centers normally have breakers that must be activated after installing the dock side cord. Make sure the dock side cord has enough slack to weather changing tides if applicable and at the same time does not come in contact with the water. Check with the marina dock master for more information on their shore power operation and requirements.

Before attempting to disconnect the shore power cord turn off all equipment and main AC breakers on the ship's control panel to prevent any component damage.

Dock Side Cord Usage Continued



30 AMP
DOCK SIDE
POWER
CORD

SHORE
POWER
1
INLET

COAXIAL
TV CABLE
INLET

SHORE
POWER
2
INLET

SHORE
POWER
WARNING
LABEL

When disconnecting the shore power cord first turn the breaker to the “off” position at the marina dock power center. Then remove the dock side cord from the marina outlet.

DANGER

**PREVENT BODILY INJURY, DEATH OR FIRE!
NEVER USE EXTENSION CORDS
OR IMPROVISED CORDS
IN SHORE POWER/MARINA INLETS.
USE ONLY APPROVED MARINE
SHORE POWER CORDS
MATCHING THE ORIGINAL
WIRE GAUGE AND AMPERAGE.**

⚠ WARNING

Electrical shock and fire hazard. Failure to follow these instructions may result in injury or death.

- (1) Turn off the boat's shore power connection switch before connecting or disconnecting the shore power cable.
- (2) Connect the shore power cable to the boat first.
- (3) If polarity-warning indicator is activated, immediately disconnect cable.
- (4) Disconnect shore power cable at shore outlet first.
- (5) Close shore power inlet cover tightly.

**DO NOT ALTER SHORE
POWER CABLE CONNECTORS**

Read and understand the shore power warning label on this page. As needed make tidal adjustments for shore power cords to ensure they do not dangle and are not immersed in water while being used.

Dock Side Cord Usage Continued

Typical 30 amp domestic shore power cords (dock side cords) contain four wires:

- Red-ungrounded conductor containing 120 volts
- Black-ungrounded conductor containing 120 volts
- White-neutral ungrounded conductor
- Green-grounding conductor

Before plugging in the dock side power cord check to see that all vessel AC breakers are off. This includes the incoming as well as both the main and equipment breakers at the AC ship's control panel. See the AC panel illustration later in this chapter.

When connecting the shore power cord be sure to twist the cord into the boat inlet plug first. The inlet plug is located on the port deck. The cord



TYPICAL 30 AMP CORD

installs one way only. Align the 2 pins with the 90 degree shape, (or use the imprinted arrows and detentes located on the inlet plug) insert the cord end

straight into the inlet plug and twist in a clockwise direction to lock in place. Screw the threaded sealing ring into the shore power inlet until tight. This protects the inlet and cord pins from moisture and possible corrosion build-up.

When not in use close and turn the covers on the shore power inlets until tight to prevent moisture from entering the plug.

Tips- Marina Shore Power Stations



TYPICAL MARINA SHORE POWER STATION

As you become a more experienced boater you may engage in longer cruises with over night stays. It is most frustrating after a day of hard boating to pull into a marina and find your shore power cord does not adapt to the marina shore power station. This may be especially true stopping at older marinas built before the 1978 National Electric Code was enacted for these facilities. Therefore, it is recommended that you purchase several shore power adapter cords to meet various marina plug footprints.

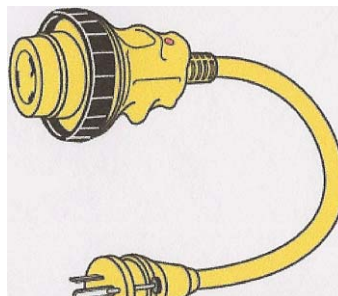

TYPICAL SHORE POWER STRAIGHT ADAPTER CORD

Carry a couple extra 125 volt/15 amp adapters with a female twist 3 prong plug to a straight blade male plug with a locking screw..

Also, purchase two reverse "Y" adapter cords, one being a 50 amp, 125/250 volt straight

blade crowfoot type with a grounding clip and the other being the 50 amp 125/250 volt with a locking ring.

A point to remember is that sometimes a chart plotter will provide local cruising information including marinas and facilities they offer but normally they do not provide the power voltage available at dock side.

Shore Power Possible Problems/Solutions



1. After the dock side cord is hooked up to the marina dock power center and the AC ship's panel main breaker for shore power 1 or 2 is activated no voltage is shown on the main panel AC volt meter.

Check the breaker on the marina dock power center to ensure it is activated.

Check the ELCI breaker/voltage sensing device. The "power" icon should show green. If a leakage fault exists a "red" icon will light indicating the breaker is "tripped". If needed, use the test button to reset the breaker.

2. The marina dock power center lacks a 30 amp twist plug inlet.

Call the dock master or marina personnel. An adapter cord may be available from the dockage facility. **NEVER IMPROVISE ANY TYPE OF CORD OR POWER INLET CHANGES!**

Additional cord adapters can be found at retail boating outlets.



WARNING

PREVENT SEVERE INJURY OR DEATH!
ALTERNATING CURRENT (AC) CAN KILL YOU!
DISCONNECT
ALL ELECTRICAL POWER SOURCES
BEFORE ATTEMPTING TO REPAIR OR REPLACE
ANY ELECTRICAL COMPONENTS.

ELCI SYSTEM

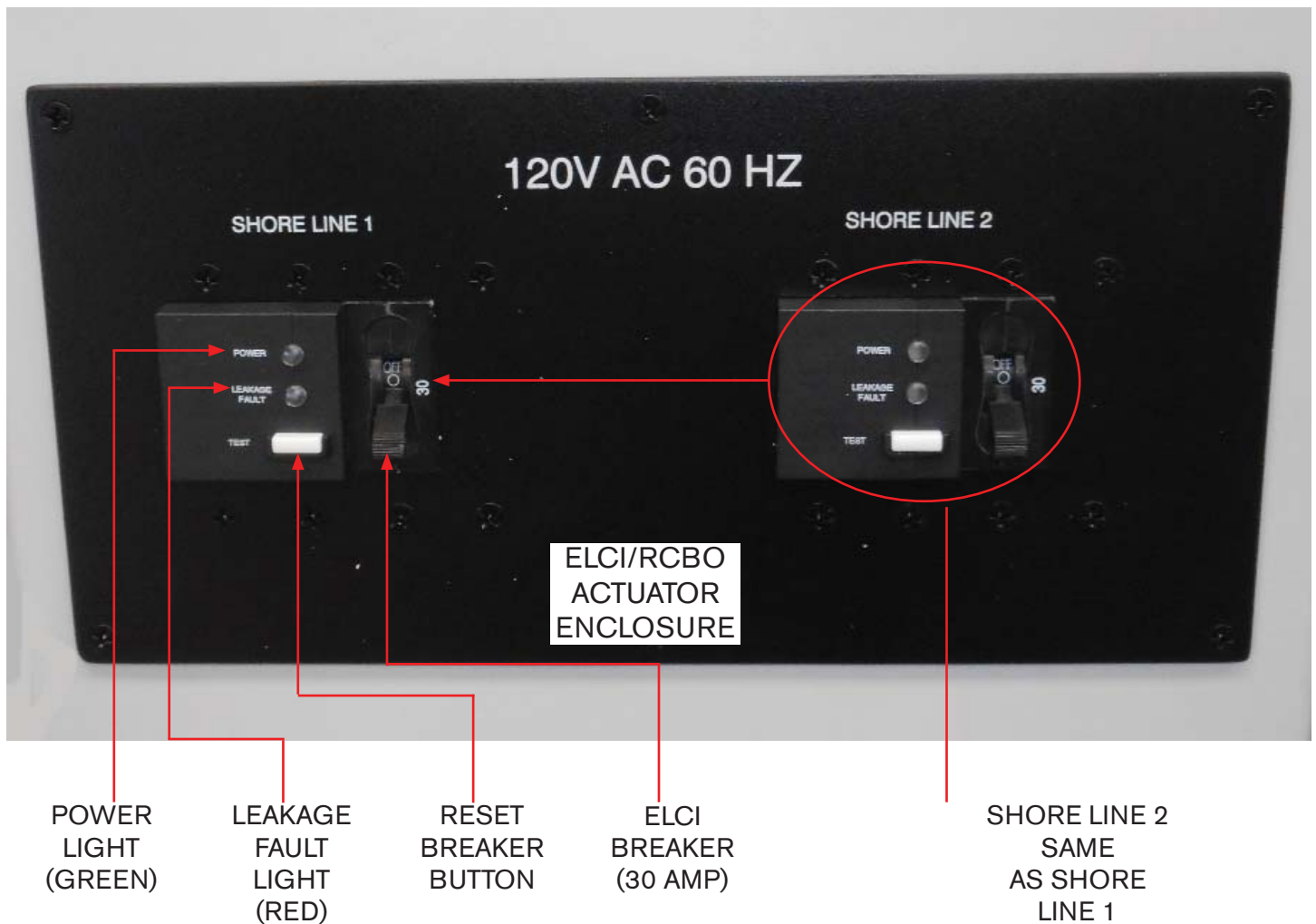

Once the shore power cords are attached to marina's dock side power and the vessel dock side power inlets current travels to the ELCI actuator enclosure.

Once through the ELCI power continues to the ship's main AC control panel culminating at the shore power main and as they are activated the auxiliary equipment breakers.

Note that both shore line breakers above are of a single throw double pole design. Both breakers above feature leakage fault technology. If the 30 amp ELCI breaker trips find the cause of the problem before resetting the breaker.

The ELCI stands for "Equipment Leakage Circuit Interrupter". There are two potential failures in a boat's electrical system that can put people on or around a vessel at risk of lethal electrical shock. In a properly functioning marine electrical system, the same amount of AC current flows in the hot and neutral wires.

However, should electricity "leak" from this intended path in these two wires to ground, this condition is referred to as a "ground fault". An example of this is an insulation failure in the wiring of an appliance.

ELCI System Continued

Furthermore, a ground fault can occur when the grounding path is broke through a loose connection or broken wire. As an example a shore power ground wire may fail due to fatigue caused by constant motion and stress. Faulty grounds can go undetected; a simple continuity test may not reveal problems.

When these 2 conditions occur at the same time, it may produce tragic results. The combination of a “ground fault” and a faulty ground could result in the metal parts of the vessel and underwater gear to become energized. If this condition exists, besides being a hazard to personnel on board there is increased danger to swimmers near the boat. The result could be shocking people on board and swimmers could receive a paralyzing dose of electricity and drown due to loss of muscle control.

An ELCI provides protection for the entire boat and features a trip threshold which provides ground fault protection for the entire shore power system beyond the ELCI.

The ELCI protection on individual shore power lines combined with GFCI'S will reduce the risk to those on the boat, dock, and in the water surrounding the vessel.

Notice that one ELCI breaker is marked shore power 1 and the other ELCI breaker shore power 2.

Another feature of the ELCI is a “leakage fault” detector located on the side of the ELCI breaker itself. The leakage fault feature detects a change in the neutral wire current.

Should the current change more than 30 Ma or about 1/3 of an amp the unit senses the difference and will “trip” the breaker causing the leakage fault LED to illuminate red. This clearly indicates that the trip occurred as a result of leakage. Before resetting the ELCI breaker determine the cause of the leakage fault.

A proper operating alternating current system will display a green illuminated LED at the “power” marked area of the ELCI.

Periodically test the ELCI by depressing the “test” button. The breaker should “trip” indicating the system is functioning properly. Simply reset the breaker. The leakage hazard helps prevent serious equipment damage and possible fire.

After the neutral and the 2-120 volt conductors exit the ELCI they run directly to the ship's main AC control panel.

The ELCI can at times undergo a process called “nuisance tripping” which can cause a “tripped” breaker. This can be caused by overloads in the electrical draw or sometimes caused from unbalanced loads. One way to minimize the situation should it occur is to monitor closer the energized devices on the vessel which will assist in keeping the total amperage used to a minimum and the loads between panel legs more balanced.

ELCI Leakage Fault Detector LED Information

As a central segment of the ELCI system there are two LED lights with a “test” button located at the shore power inlet. With the breaker in the ‘on” position and the shore power cord hooked up these LED lights may show variations in color to provide system conditions.

They are:

1. Green LED On- Red LED Off

Line voltage is present, the breaker is closed, and the device is protecting the circuits against over current and leakage current.

2. Green LED Off, Red LED On

The device has detected leakage current and has opened the circuit breaker.

3. Green LED flashing, Red LED Off

The circuit breaker has opened due to over current or has been manually turned to the “off” position.

4. Green LED Off, Red LED Off

Line voltage is not present. Check cord connections and marina breaker for “on” position.

Note: Check circuit at least monthly by pushing in the white switch marked TEST. When depressed, the breaker should return to the reset position indicating the ELCI circuit is operating properly.

For further information on the ELCI PC-S refer to the Carling web-site. *Note that both shore power 1 and 2 use the same testing procedure.*

AC Ship's Panel (Typical)

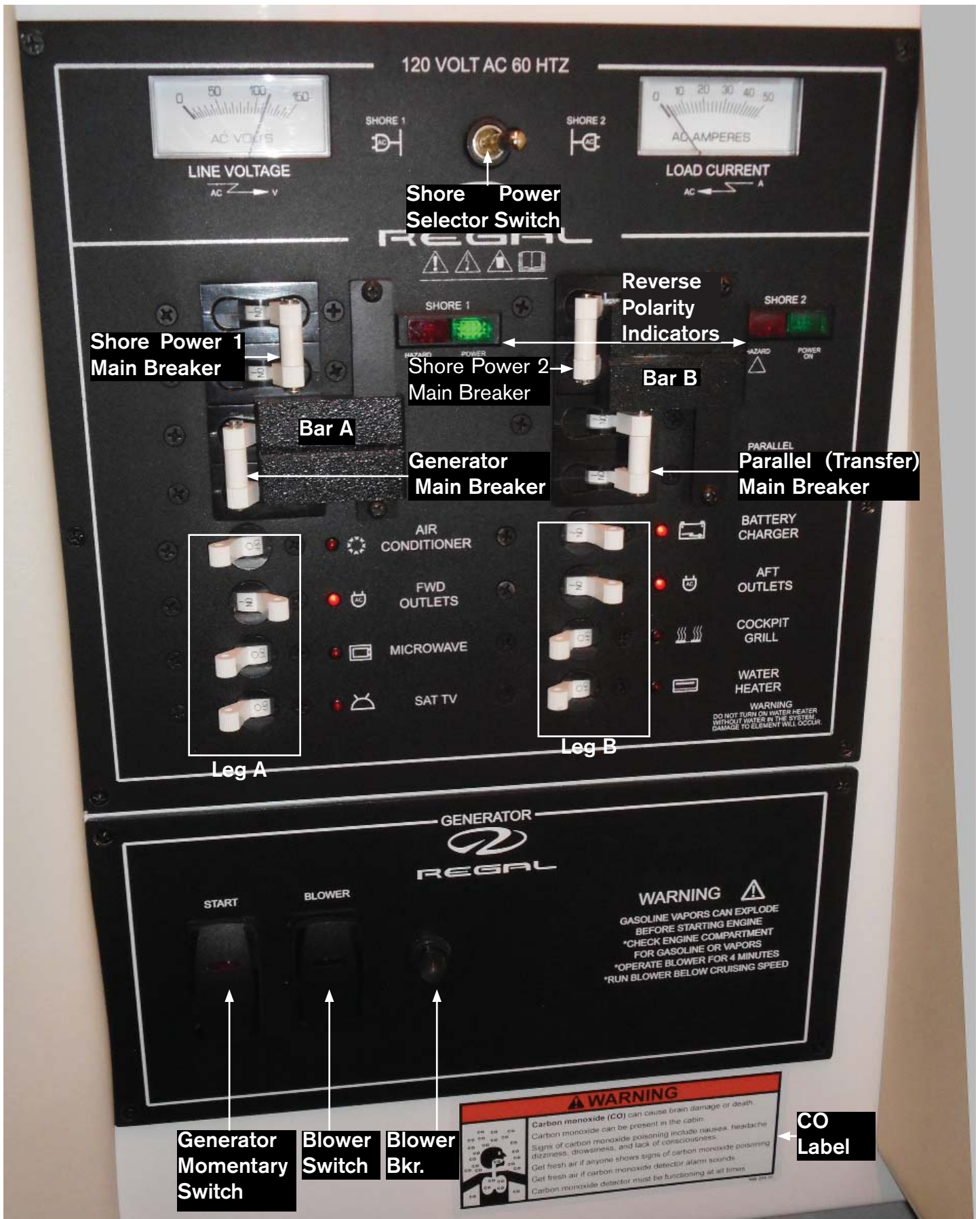

AC Ship's Panel Continued

The typical AC (alternating current) ship's panel controls all high voltage components on your vessel. This panel is 120 volts AC on twin legs. Equipment is controlled by individual breakers. Voltage is supplied by either a shore power cord (moored) or by generator (at sea). The panel features voltage and current displays.

We will discuss each major feature. Refer to the photo on the previous page to enhance each component reviewed.

Reverse Polarity Indicator

Before activating a 30 amp shore 1 or 2 breaker visually check for a green light at the reverse polarity indicator. The green light indicates there is no reverse polarity. If a red light appears on the reverse polarity indicator a hot wire and ground are probably reversed somewhere in the circuit from the dock to the main panel.

In all cases do not activate the main inlet breaker. Take immediate corrective action to find the cause of the reverse polarity situation. At this point, disconnect the shore power cord from the marina power center and call for professional assistance.

30 Amp Main AC Panel Shore power Breakers

As mentioned earlier, there are two main shore power breakers on the panel labeled shore 1 and shore 2. These single throw, double pole main breakers control power to that side of the panel and when activated deliver electricity through a system of sub breakers to the entire boat through dedicated legs of the panel. Before you energize the main breaker make sure all sub breakers are deactivated.

This prevents any excessive equipment motor draws and may eliminate any system arcing.

With the reverse polarity indicator displaying the green icon, activate shore breaker 1 by flipping the single throw arm to the on position. AC electricity now is distributed to that leg of the panel.

On the shore power 2 main breaker after bar A is moved down pull the transfer switch to the left which will allow shore 2 breaker to be activated. Now the entire panel is powered up.

At this point turn on sub breakers as needed always being conscious of the load current meter.

50 Amp AC Generator Breaker

When the vessel is under generator power at sea AC electricity is distributed through the 50 amp main generator breaker located on the AC main ship's panel beside the main breaker. See the previous illustration and the generator section for further information. Before activating the generator AC breaker it is recommended to make sure all equipment breakers are "off."

After starting the generator activate shore 1 breaker. Then push Bar B on the generator portion of the panel up and then activate the generator breaker.

With the generator running activate shore 2 by flipping the shore 2 breaker to the on position. Move the bar up and flip the transfer switch to the "on" position which will direct current to shore 2 main and sub breakers.

AC Ship's Panel Continued

Line Voltage/Current Meters

After the shore power 30 amp main breaker or generator 50 amp breaker is activated line voltage will display on the the main panel.

As sub panel equipment breakers are activated the load current meter (extreme right side of panel) will show an amperage draw. Normally the amperage will ascend as more equipment breakers are activated and will descend as equipment breakers are deactivated.

Shore power 1 & 2 Switch

The 120 volt shore power 1/2 switch is located between the line voltage and load current meters. With the shore power switch in the "center" position it is off. When the shore power switch is toggled to the left the line voltage meter will display up to 120 volts available at Shore 1. As equipment breakers are activated the load current (amperage) meter will ascend and descend as equipment breakers are deactivated.

When the shore power switch is toggled to the right the line voltage meter will display up to 120 volts available at Shore 2. As equipment breakers are activated the load current (amperage) meter will ascend and descend as equipment breakers are deactivated.

The shore power 1 & 2 switch shows present usage equipment amperage can be a great tool for balancing loads between panel legs. This will help prevent circuit and panel overloads, power surging, and voltage drops.

As a general note on equipment breakers when leaving the yacht it is recommended that most breakers be turned off. It may be necessary if items are left in the refrigerator to leave the shore power cords hooked up and the battery charger on during extended periods along with the cockpit DC refrigerator since the charger keeps the batteries up.

120 Volt Main Panel Breaker Description (Typical)

Leg A

Air Conditioner- This 20 amp breaker controls the cabin air conditioning unit.

Fwd. Outlets- This 15 amp breaker controls the 120 volt GFCI and outlets downstream and the optional mid berth television.

Microwave- This 15 amp breaker controls the cabin microwave.

Sat TV Antenna- This 10 amp breaker controls the optional KVH satellite television antenna.

.

Leg B

Battery Charger- This 10 amp breaker controls the battery charger located in the bilge. It is recommended that when leaving the boat for extended periods this breaker be left energized in order to keep the ship's batteries in a charged condition (dock side cord must be hooked up).

Aft Outlets- This 15 amp breaker controls the 120 volt GFCI and outlets downstream and the optional mid-cabin television.

Cockpit Grill- This 20 amp breaker controls the cockpit electric grill.

Water Heater- This 15 amp breaker protects the hot water heater installed in the engine room.

GFCI Outlet (Ground Fault Circuit Interrupter)

Sometimes current in a circuit escapes its normal route and finds a “ground fault”. If that vehicle ends up to be your body and the current passes through your heart the results could be deadly. The outlet contacts close between 4 and 6 milliamperes.

A ground fault interrupter or GFCI senses the difference between the hot and neutral wire current before a fatal dose can be conducted and in a fraction of a second cuts the current.

The GFCI devices used in homes are normally not ignition protected and of the 15 or 20 amp variety. Your boat uses a 20 amp GFCI. By using a GFCI as the first receptacle in the circuit all the receptacles down stream on the same circuit are protected by the initial GFCI. This is accomplished by attaching the lhot wires to the line terminal of the GFCI receptacle and the out-going hot wire to the load terminal. The neutral wires also use line and load terminals on the opposite side of the GFCI receptacle.

You can identify the GFCI primary receptacle by the test and reset breaker in the center of the device. Check the GFCI protection monthly. If a problem develops with the GFCI circuitry call a marine electrician to access the situation.

The GFCI outlets are especially useful when electrical equipment is employed such as a drill or in the head with the use of personal devices such as curlers and hair dryers. Never use any electrical devices when puddling water is present to prevent a possible shock hazard.

Note: See the GFCI description on the following page.

The GFCI is programed to protect a person from line to ground shock hazards which could occur from various electrical devices operating off of the device or receptacles down stream. It does not prevent line to ground electric shock, but does cut down the exposure time to a fraction of a second before the device trips. It does not protect people against line to line or line to neutral faults. Also, it does not protect against short circuits or overloads; this is the circuit breakers job.

All GFCI's should be tested monthly to make sure they and the receptacles they protect “down-stream” are protecting against ground-faults.

GFCI Outlet (Ground Fault Circuit Interrupter)

Newer style GFCI's must automatically monitor ground fault interrupting functionality every 3 hours or less. If the device can no longer provide GFCI protection, it must deny power and provide a visual indication that it can no longer provide protection.

Your boat uses a GFCI's featuring the following:

1. Power indicator (solid green)
2. Trip indicator (solid red)
3. "End of life" indicator (flashing red)

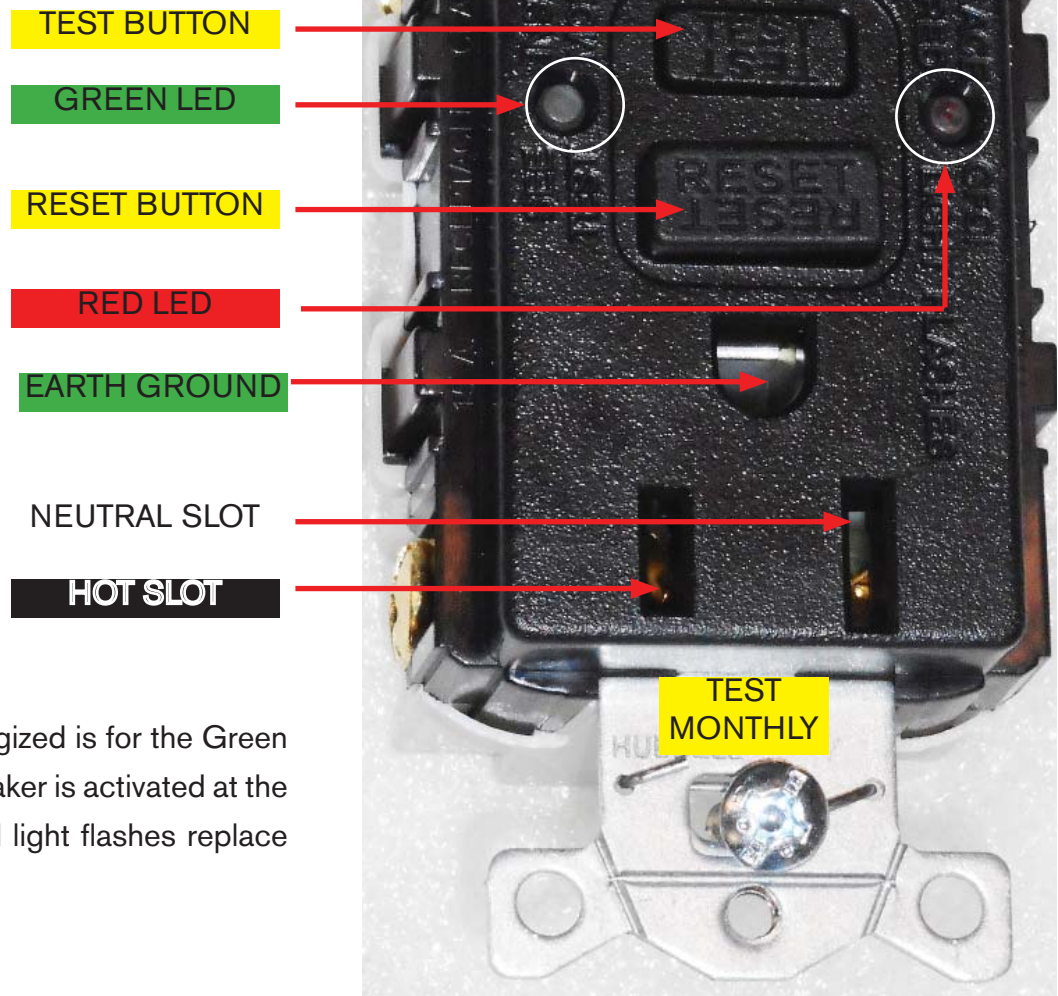

Normal operation when energized is for the Green LED to light as the outlet breaker is activated at the main AC ship's panel. If Red light flashes replace GFCI receptacle.

GFCI Outlet Continued

Testing GFCI'S

To test a GFCI find a 120 volt night light or small lamp to plug into the GFCI outlet. Try it in another circuit first to make sure it lights.

After the lamp is plugged into the GFCI outlet the lamp should light. Now press the “test” button at the GFCI receptacle center. The GFCI's “reset” button should pop out and the lamp should go out. This means the GFCI itself is functioning properly. Press the “reset” button to restore power to the outlet. Test each GFCI circuit monthly.

You can use the lamp to check receptacles downstream from the GFCI. All receptacles should light the lamp and should go out when the “test” button is pressed.



Also, GFCI downstream receptacles can be tested with a plug-in type GFCI tester. This tester contains a GFCI test button which accomplishes the

same thing as the GFCI receptacle built-in test button. This tester can be purchased at electrical supply houses or marine retailers.

Ignition Protected Devices

Many electrical devices in everyday use tend to “arc” or spark when being used. These include motors, fans, switches, relays, etc.

Boats in general use many of these same devices but they are protected from any sparking that may cause the device to ignite with any vapors that are typically found in the engine room and/or fuel tank compartments.

When replacing any electrical device especially in the bilge or engine room make sure it is ignition protected. This means it has been tested and normally the device is stamped with a marking making it safe to use. Most automotive type devices are not ignition protected especially engine starters and alternators.

Note smaller hose barb for generator feed and return.

Possible Problems/solutions (GFCI's)

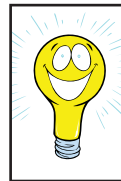

1. If the “reset” button does not pop out, the GFCI is probably defective and should be replaced.
2. If the “reset” button pops out one time but tends to stick the next the

GFCI should be replaced.

3. The GFCI “reset” button pops out when something is turned on. This may indicate an internal wiring problem with the GFCI or there may be a ground-fault downstream.

4. The GFCI “reset” button is in the pressed position and nothing works. Check the appropriate breaker at the main ship's AC control panel to make sure it has not “tripped” or as been deactivated.

Galvanic Isolator (Typical)

As part of the AC boat circuitry the green ground wire takes a different path. It enters via the boat's shore power inlet and travels to a galvanic isolator. Isolator is located behind ship's main AC panel.



A 60 amp (60 hertz) galvanic isolator for domestic use is connected in series with the AC grounding

“green” wire. The purpose of the galvanic isolator is to isolate the boat's grounding system electricaly from the dock and other vessels below 1.4 volts but to maintain a connection to the shore green ground at high voltage potentials. The low voltage isolation will prevent the vessel's zinc from protecting the underwater metal hardware on another vessel sharing the same AC common green ground wire. This eliminates the possibility of galvanic interaction from other boats on the same dock circuit and permits your anodes to protect your boat. The green ground or “bonding wire” runs from the boat's shore power inlet to a galvanic isolator stud. From the other stud of the galvanic isolator it runs to the AC ground buss located behind the AC main ship's control panel in the salon. Note that the stud nuts must be torqued and maintained at 8.8 inch pounds.

Since the galvanic isolator is not polarized either terminal can be used for the inlet or outlet side for the green grounding wire. See the illustration.

There is a fan located at the right side of the isolator identified by an array of ventilation holes. If you ever hear the fan running the isolator has failed. Disconnect shore power at boat & check system.

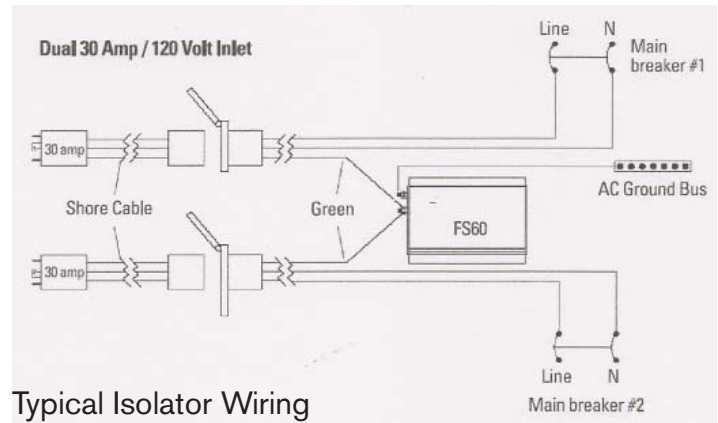

Typical Isolator Wiring

Precautions/Galvanic Isolator Warnings

Warning- It is extremely dangerous to swim or be in the marina water due to potential AC current that may be present in the water. Take all necessary precautions as this may be life threatening.

Caution- This device does not provide a status monitor. Following a lightning strike this unit may not continue to provide galvanic isolation protection.

Warning: The fan will operate only when there is a fault to ground and the isolator is conducting current. If you notice the fan running immediately disconnect the shore power and contact a qualified marine electrician to isolate and repair the problem with the boat or the shore power connection. Remember, never cover the fan holes.

Caution: Never test the isolator. Troubleshooting the galvanic isolator shall be done by qualified personnel only.

AC Generator-Typical

Overview

The current 6.5 KW generator (gen-set) is used to provide on board alternating current (AC) when the vessel is unplugged from the dock side cord. Generator frequency known as hertz is domestically set at 60 while overseas countries normally require a setting of 50. As the generator reaches full rated no load output (amps) at 60 hertz it should display 120 volts. At 50 hertz it should display 230 volts. The generator option is located in the engine room. Some basic system components are identified below. The generator features a sound enclosure which reduces noise and enables quick access for most inspections, troubleshooting and routine maintenance.

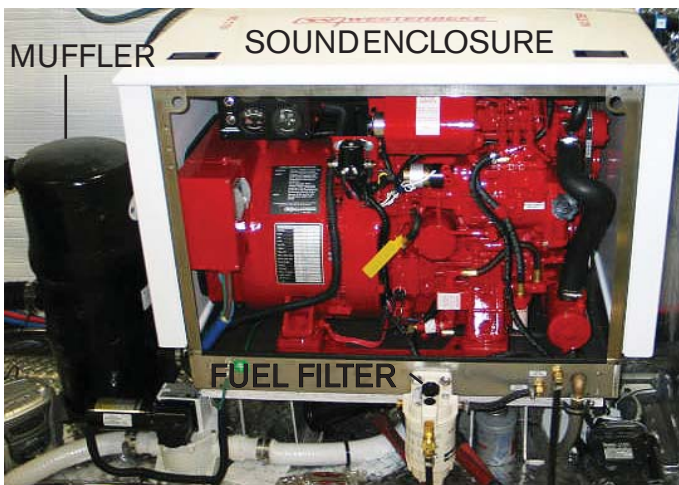

The generator is located in the port aft bilge accessible through the Lazarette storage hatch.

Typical Generator Fuel System

The generator is supplied by the same fuel tanks as the engines. The generator feed valve is normally marked for identification purposes.

Familiarize yourself with the location of all equipment and valves.

Note: Normally the generator feed and return use a 1/4" inch barb fitting located on the fuel tank. The feed portion will use a anti-siphon valve.



The fuel system features an in-line fuel filter located close to the generator. It's job is to keep fine particles and water out of the generator fuel system. Refer to the vendor information for periodic

maintenance schedules. Clean fuel is the life line of generator performance.

Since water is heavier than fuel it will settle at the bottom of the water separator filter. Periodically check the filter for foreign debris and water in the fuel supply. To check the filter unscrew the filter using an oil filter type wrench that fits on the bottom. Do not use a strap type wrench since it may distort or damage the filter housing. Use an environmentally safe container to catch any contaminated fuel. Dispose of according to local, or state regulations. Carry extra water separator filters on board.

When you turn the filter upside down note that any water in the gasoline will gather at the bottom of the container since it is heavier than gasoline and will appear as a different color and consistency and normally will move back and forth independently from the gasoline mixture in the container.

After inspection spin on the filter by hand until tight. Start the engine and check for fuel or air leaks.

Typical Generator Electrical System

The generator starting system uses the house battery. The generator is normally started at the 12 volt ship's control panel located in the cabin but it can also be started using the remote instrument panel located at the generator itself as needed. The latter is especially useful while maintenance is being conducted.

The generator remote instrument panel shown at the right features temperature, oil pressure, exhaust, speed, hour meter, on/off, start and stop switches. This panel is found inside the access door on the generator sound enclosure in the bilge. The start and stop switches by name and function are identical to the switches on the remote panel.

As part of the generator electrical system an 8 amp fuse protects the remote instrument panel wiring circuit. See illustration.

The emergency stop switch shuts the fuel off to both the remote and ship's main control panel and is normally for maintenance purposes. See illustration.

A DC manual reset breaker protects excessive current draw or electrical overload anywhere in the generator engine wiring. Should this breaker trip the generator will shut down. Reset the breaker only after the cause of the problem has been determined. See illustration.

An AC breaker will automatically disconnect any generator AC power from reaching the main ship's control panel in case of an electrical overload. It can be manually shut off when performing generator maintenance to ensure no AC power is coming out of the generator. See illustration.



Before Starting Generator

The following items should be checked each time before starting the generator. This covers the basic system components.

- ☑ Turn generator sea cock off. Check strainer for debris. Turn generator sea cock on before starting it.
- ☑ Ensure that all main panel and equipment breakers are off.
- ☑ Inspect the generator for fuel, oil, exhaust or water leaks.
- ☑ Check generator engine oil level. Top off with correct viscosity as required.
- ☑ Check coolant for proper level at recovery tank. Add as needed.
- ☑ Check the main fuel tank to ensure there is adequate gasoline for both the generator and the engines. Apply the one-third rule.
- ☑ Check for loose wires at the alternator.
- ☑ Check the port side cranking battery (weekly).
- ☑ Check drive belts for wear and proper tension (weekly).
- ☑ Record the hour meter reading to meet maintenance scheduling.
- ☑ Check the blower for proper operation. Start blower and let run at least 4 minutes before attempting to start the generator. Run blower continuously while generator is running.

Typical Generator Exhaust System

The generator exhaust system features a dual tier operation. As the water and exhaust exit the generator they travel to the muffler. The muffler discharges the heavier water out the muffler bottom and through the hull. The exhaust itself is exited out the muffler top and through the hull. The benefits of the system are two-fold. First, the actual decibel or sound level is decreased. In addition, the lower resonating sound is more pleasing to the ear. For colder climates, a drain plug is installed in the muffler.

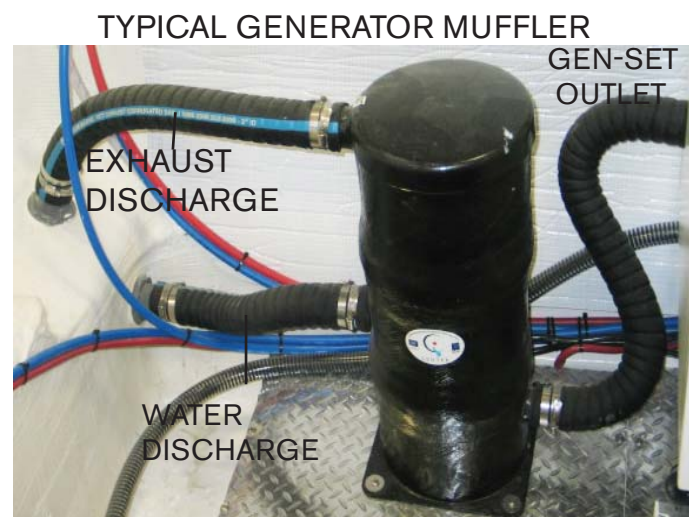

Before departure always check the hose connections for signs of water and air leaks. Tighten hose clamps periodically as needed. Check entire exhaust system for leaks and fastener tightness.

After starting generator, check for water flow at the generator discharge.

Starting Generator

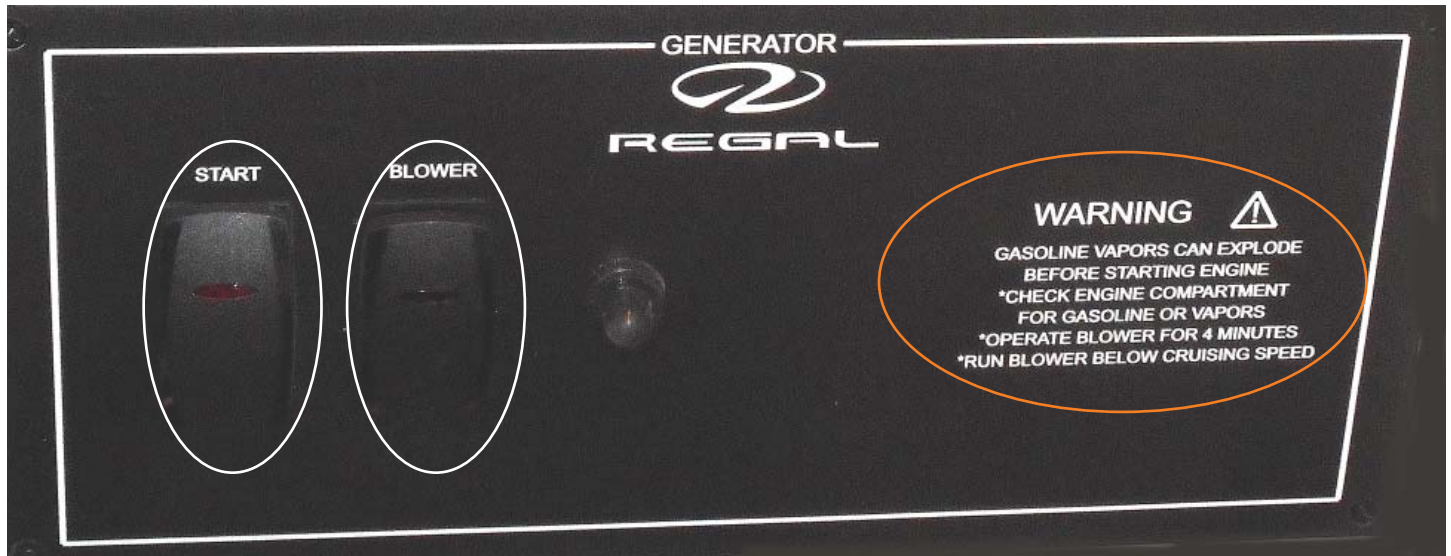

The following generator starting information is specified for use at the ship's main control panel located in the cabin. *It also assumes that the checklist on the last page has been completed and all system components are in good running condition.* For further information, contact your closest Regal dealer, refer to the generator operation manual and/or the illustration of the ship's panel.

1. Turn "on" the generator sea cock in the engine room.
2. Check the ship's main control panel to ensure shore main and all equipment breakers are deactivated.
3. At the ship's main control panel activate the generator blower. Let it run for at least 4 minutes before starting the generator. See warning above.
4. Push down on the "start" switch and hold. This will engage the generator starter to crank over the gen-set engine.
5. Once the generator starts, release the "start" switch.
6. Let the generator run without a load for several minutes.

7. At the ship's main control panel slide the starboard parallel (transfer) bar up.. Activate the breaker.

8. Push the port bar up. Activate the generator breaker.

At this point AC voltage should display on the AC line voltage meter.

9. Activate the desired AC equipment breakers.

Stopping Generator

To stop the generator follow these steps at the ship's main control panel;

1. Turn to the "off" position all AC equipment breakers.
2. Turn to the "off" position the 50 amp AC generator breaker. At this point, no AC line voltage will be displayed at the AC volt meter. Let the generator run for 3-5 minutes without a load to cool down.
3. Stop the generator by pressing down the "stop" switch on the panel shown above. Hold until it stops.

Possible Problems/Solutions



1. With generator main control panel activated there is no voltage at the AC line voltage meter. Check AC output breaker on the generator. It may of tripped due to an overload.

2. The generator quit do to overheating. Check the generator strainer for obstructions such as seaweed, plastic, or shellfish. Be sure to turn off sea cock before removing the strainer basket.

3. The generator will not start from the main ship's panel after being serviced. Make sure the generator mounted emergency stop switch is in the "off" position and the breaker has not tripped..

4. The generator will not crank over to start. Check-out the house battery and battery switch.

Generator Sea cock/Strainer

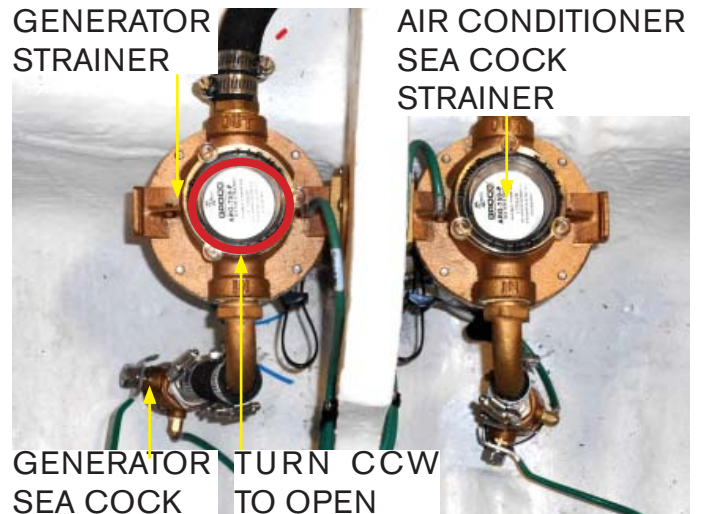

Looking aft in the Lazarette storage area note the generator and A/C sea cocks and strainers. Always insure the handles are in line with the hose indicating an open condition. This will permit seawater to circulate through the generator.

To service any onboard strainer make sure the sea-cock handle is in the "off" position at a 90 degree angle to the hose. Turn the strainer top to access the basket, Pull the basket out and remove any debris. Reinstall basket and tighten strainer top. Set the sea cock handle to the "open" position. Start generator and check for leaks.

Air Conditioning

The current air conditioning system features domestically a 12,000 BTU output at 115 volts and 60 Hz. The system utilizes a single pump which delivers cooler seawater to the evaporator/condenser. The drain pan is rust free molded composite. Residue water exits through the shower box. Warmer seawater exits the vessel through a manifold and various thru-hull fittings.

A vibration isolation system reduces noise. The sound cover provides up to 50% further noise reduction which amounts to 3-5 db's.

The evaporator/condenser unit incorporates a compressor to compact the R-410A refrigerant which is comprised of fluorinated greenhouse gases.

The Elite control panel (thermostat) is centrally located in the cabin to serve the vessel needs. A set of control panel reference system codes is provided for any type of service issue.

The A/C pump is located in the engine room. It provides sea water to operate the A/C unit located under the forward berth floor.

Note: If the vessel is hoisted out of the water (except for winterization) make sure the A/C sea cock is turned to the "off" position before lifting the vessel. Failure to do so may cause the air conditioner to lose its prime and the A/C pump may quit on start-up do to a lack of water or cause pump failure. Remember to turn the sea cock "on" before re-starting the A/C unit.

TYPICAL AIR CONDITIONING EVAPORATOR/CONDENSER UNIT

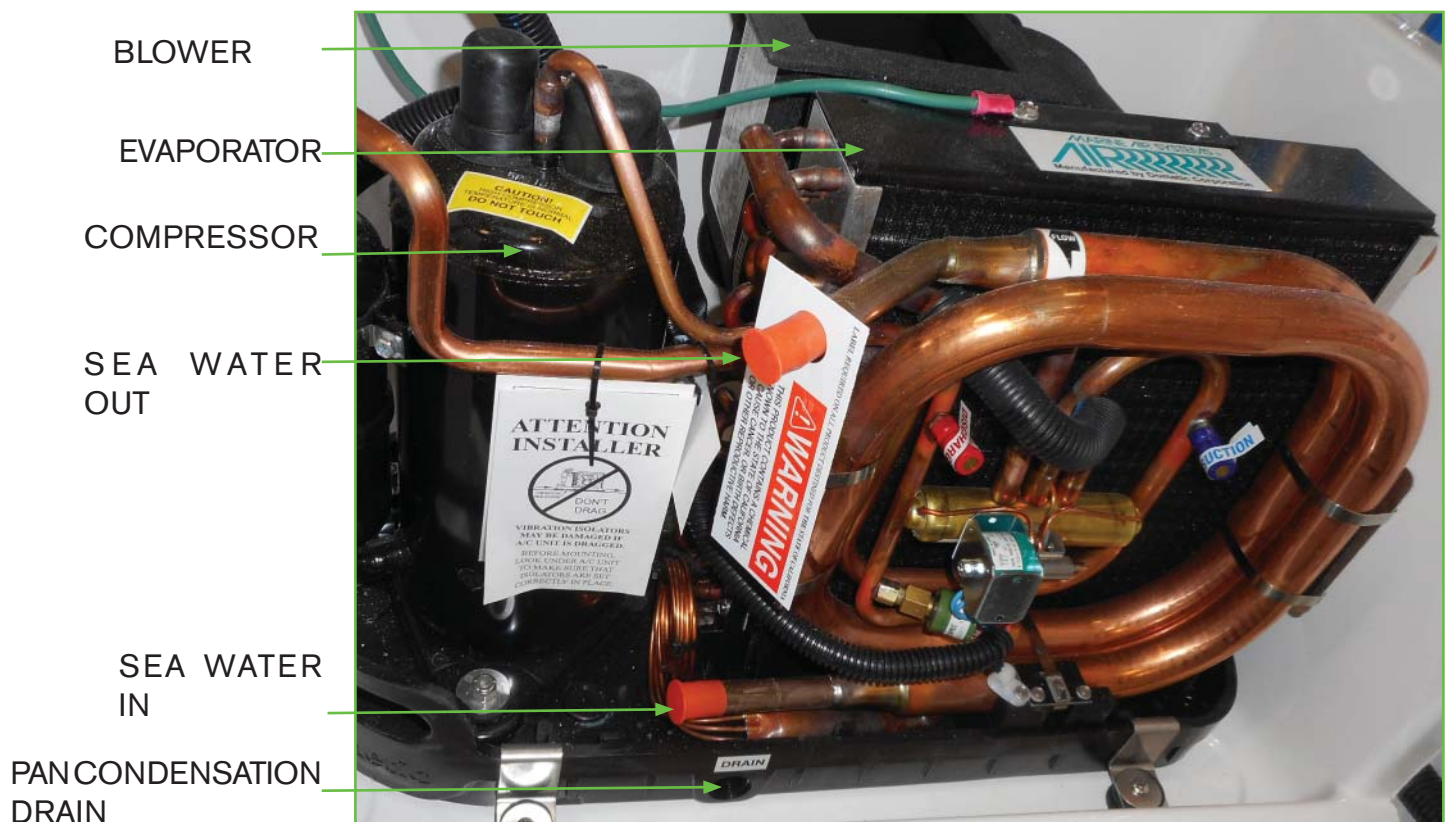

Reverse Heat

The air conditioning system feature a reverse heat cycle. This can be extremely valuable to boaters in colder climates especially for early spring and late fall cruising.

To accomplish reverse cycle heating, the R-410A refrigerant flows in the opposite direction through a reversing valve located on the evaporator/condenser unit. Heat is transferred from the seawater in the coil of the condenser to the R-410A refrigerant and then to the air as it is blown through the evaporator to the cabin.

Obviously, the temperature of the seawater will affect the air conditioner efficiency.

The temperature variance for cooling efficiency is:

Up to 90 Degrees F. (32.2 Degrees C.)

The temperature variance for heating efficiency is:

Down to 40 Degrees F. (4.4 Degrees C.)

Typical Air Conditioning System Operation

Below is a basic quick start-up checklist for the air conditioning system. For more in depth information, refer to the vendor operation manual.

Operations Quick Start-Up Checklist:

1. Check the AC seawater strainer for debris.
2. Make sure the AC seawater pump sea cock located in the engine room is opened completely (handle should be in-line with the hose).
3. Activate the forward air conditioner breaker on the boat's main AC control panel located on the cabin wall.
4. Check the hull side for a steady stream of seawater. Seeing water here is normal when the AC pump is running. If stream is diminished or no water emits from the fitting immediately turn the AC pump off and investigate the cause of the problem.
5. Press the Elite thermostat Power button once to activate the air conditioning system. A blank screen displays when system is off and indicates present cabin temperature.
6. For cooling or heating press and release the Mode button until the desired LED is illuminated ie; automatic mode.
7. Press the Up or Down button to set the desired cabin temperature. To view the set point, momentarily press and release the Up or Down button.
8. Auto fan LED lights when Auto fan speed is selected.

TYPICAL ELITE AC CONTROL DIAGRAM

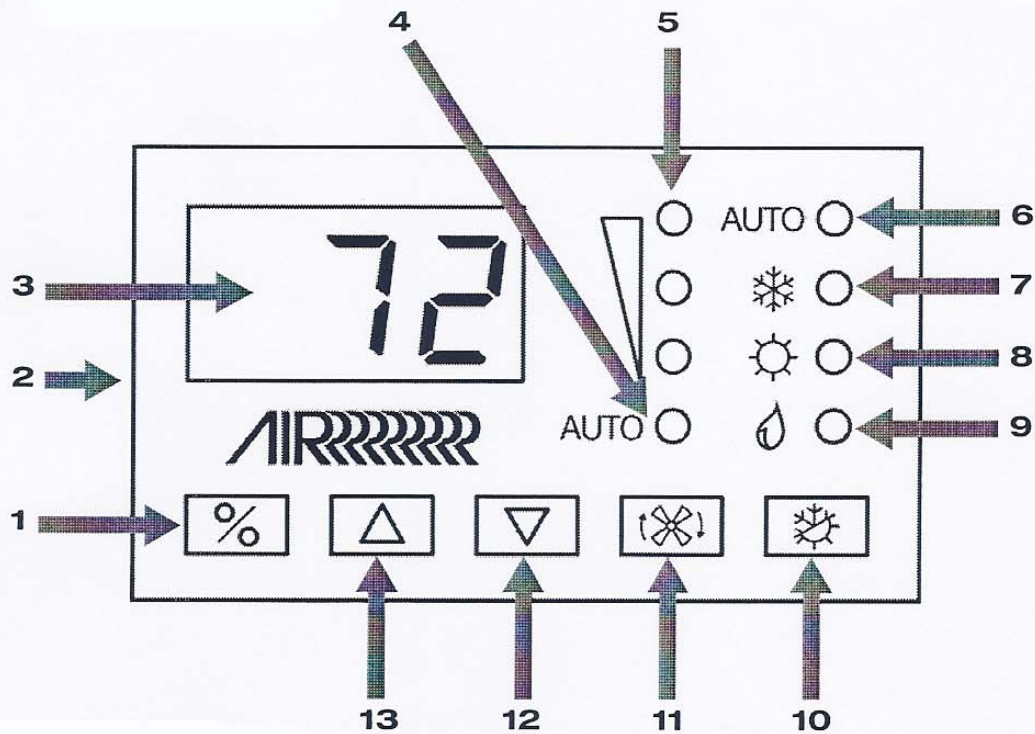

Elite Display - Diagram Legend

1	Power button	8	Heat Mode indicator
2	Temperature sensor	9	Moisture Mode indicator
3	Digital display	10	Mode button
4	Auto Fan indicator	11	Fan button
5	Manual Fan indicator (high, medium, low)	12	Down button - Lower temperature set point
6	Auto Mode indicator	13	Up button - Raise temperature set point
7	Cool Mode indicator		

Note: The Elite display continually monitors the system components. Should a problem develop it sends a diagnostic code to the control (thermostat) display. Refer to the vendor air conditioning manual (troubleshooting section) to assist in identifying the problem.

TYPICAL A/C INSPECTION TIPS

Seawater Strainer



TYPICAL A/C SEAWATER STRAINER/BASKET

The air conditioner seawater strainer located in the bilge and should be cleaned periodically of debris which can inhibit or stop the fresh sea

water supply.

Always turn the sea cock handle to the off position (90 degrees to the hose fitting) before cleaning a seawater strainer.

Remove the basket by turning the plastic cap in a counterclockwise direction. Set the cap and the O ring aside. Pull the basket from the unit, rinse with water, air dry and reinstall. Sediment at the bottom can be removed by just turning the plug in a counterclockwise direction. Place a container under the strainer to catch the sediment. Coat the O rings with waterproof grease containing a silicone or teflon base. Reinstall O rings along with the plug and plastic cap. Turn on and check for leaks.

Return Air Filters

Once a month check the return air filter located on the face of the evaporator. To clean rinse with fresh water, air dry and reinstall.

Also, there is a metal mesh style air filter in the main cabin behind the register that periodically needs to be serviced. Open up both register latches and the filter is behind the grille. Use fresh water and dry thoroughly. Reinstall filter and latch register.

Drain Pans

As noted on an earlier page the AC evaporator/condenser features a 2" deep drain pan connected by a hose that runs to a sump pump and eventually exits overboard. Periodically just like your home AC, the pan needs to be rinsed clean of debris and possible mold.

You can use a purchased product made specifically for cleaning AC units. Disconnect the outlet hose from the AC pan and install made up hose (5/8") that will catch the used solution to fill a small container. Dispose of the container in accordance with federal, state and local regulations. Pour the solution into the pan and allow time for it to drain. Reconnect the original drain pan hose when finished.

Condenser Coil Cleaning

Periodically the condenser coils are recommended to be cleaned. This procedure should be done by a professional since an acid solution must be used.



WARNING

PREVENT INJURY OR DEATH!
DISCONNECT
ALL ELECTRICAL POWER SOURCES
BEFORE ATTEMPTING
TO OPEN, REPAIR, OR REPLACE ANY
AIR CONDITIONER COMPONENTS.

Possible Problems/Solutions

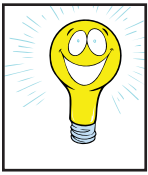

1. No or little water is noticed at the thru-hull fittings and a HPF fault code shows on the display which means the high pressure switch is open.

The strainer or intake hose may be clogged, sea cock may be closed a hose may be collapsed or the AC pump may be defective.

2. Air conditioner will not start. Ensure the proper AC breaker is activated on the ship's main control panel.

3. No cooling or heating. Lower or raise set point on thermostat control to offset set point being satisfied. Check for obstructed seawater flow. Remove discharge side of pump hose to purge air (air-lock). Seawater temperature too high for cooling and too low for heating.

4. Fan coil is iced. Raise or lower control set point. Clean return air filter. Switch AC to heat until ice melts or as a last resort use a hair dryer to melt ice as needed.

Gasoline Fuel System

In this section, a typical EPA approved domestic gasoline fuel system is introduced. The fuel system includes the fuel tank, fuel feed lines, fill and vent fittings along with fuel filters, emission devices, natural and powered ventilation systems.

Gasoline today is processed in a different manner than it was a few years ago. As a result it has become more unstable and the product shelf life has been shortened.



Outboards in this size range normally utilize a metal fuel tank. A special low permeability bulb and hose is supplied by the engine manufacturer to feed the fuel from the tank to the outboard engine.

Sometimes it is necessary to pump the gas line hose bulb before starting the engine. *Note that the fuel line bulb and hose for each engine is in the lazarette storage area.* If the need arises to replace the fuel bulb be sure to turn the arrow imprinted on the bulb toward the engine side for correct fuel flow.

Read and understand the outboard owner's manual fuel section and safety information before attempting to use the vessel.

Note that due to a possible fire or explosion danger never store flammable liquids and/or portable outboard fuel tanks in any onboard storage compartment such as the cockpit Lazarette locker.

Gasoline Specifications/Octane Ratings:

Gasoline Requirements- Use premium non-leaded gasoline with the following minimum octane rating for Yamaha outboard engines:

• **Minimum pump octane number (PON) is 89.**

The use of leaded fuels will damage the catalysts and can not be used with catalytic converters.

Gasoline in the United States and other areas is blended with 10% ethanol and is known as E-10 at the pumps. Marine engines used in your Regal boat may be operated with premium unleaded gasoline blended with no more than 10% ethanol and that meets the minimum octane specification.

Do not use ethanol blends greater than 10% such as a newer blend for select motor vehicles called E-15. Your marine engine may be damaged by more than 10% ethanol. A loss of performance may occur and the engine will not be covered by the engine manufacturer's warranty.

Refer to your outboard manufacturer's operation manual for additional information regarding the proper octane level for your outboard model. Using the wrong octane level may cause permanent engine damage such as piston detonation.

As an option contact your outboard manufacturer's hot line or text on web with fuel related questions. Also, additional fuel system information may be as close as your Regal dealer. Your Regal dealer has special training on the propulsion and Regal vessel systems.

Typical EPA Outboard Fuel System

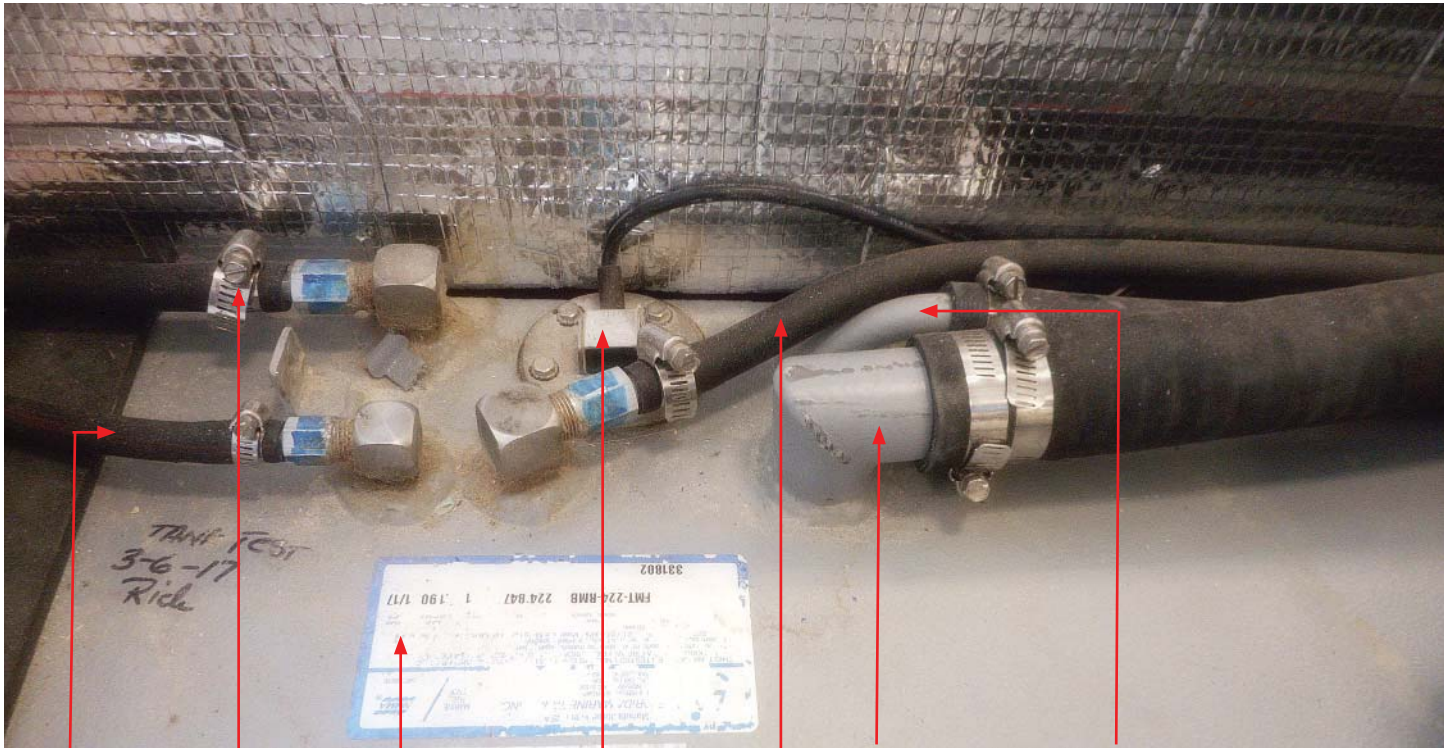

GEN-SET ENGINE TANK FUEL ENGINE FUEL FILL & HOSE TANK VENT & HOSE
FEED FEED/HOSE LABEL SENDER UNIT FEED

Typical Fuel Tank

Vessels manufactured for *domestic* use are now required to be outfitted with an EPA compliant fuel system using an aluminum tank that passes a variety of tests. This system uses special valves and baffles located inside the fuel tank along with special hoses marked for low permeability. Also, there is a carbon canister in-line with the vent hose which functions much like the one in an automobile by filtering gas fumes. The carbon canister rarely needs to be replaced and is not a serviceable item.

These tanks are tested and inspected along with the complete fuel system several times for safety requirements and quality by the fuel tank supplier, in house personnel and independent inspections by National Marine Manufacturers Association personnel.

Fuel Fill Fitting

The fuel fill fitting is labeled “gas” and in addition displays the international symbol (See the next page). When fueling the boat keep the fill nozzle in contact with the fuel fill pipe since it decreases effects of static electricity. Always use the recommended fuel octane rating as specified in your engine owner’s manual.

Extinguish all flame producing agents before fueling!

WARNING

AVOID SERIOUS INJURY OR DEATH FROM FIRE OR EXPLOSION, RESULTING FROM LEAKING FUEL. INSPECT SYSTEM FOR LEAKS AT LEAST ONCE A YEAR.

Fuel Vent Fitting - Typical



COMBO FUEL FILL/
INTERNAL VENT

Currently, domestic EPA compliant fuel tanks vent fumes back into the fuel tank system. While the tank is filled, air displaced by the incoming fuel is vented through the fuel system charcoal canister.

Your vessel uses a combo type (internal vented) fuel fill. Both the fuel fill and vent occupy the same cavity under a protective cover. If fuel overflows through the vent the design forces it back into the fuel fill hose and tank. Be sure to tighten the fuel fill cap to prevent water and debris from entering the fill system.

A seasoned skipper will hear a distinct sound as the tank nears the “top out” or full mode and may see fuel overflowing back into the fuel hose through the vent. On select vessels not using an EPA fuel system there may be a separate vent fitting on the hull side. Periodically check this vent screen for debris and insect activity.

NOTICE

DO NOT OVERFILL THE FUEL TANK!
THIS HELPS AVOID ANY OVERBOARD
SPILLS WHICH MAY HARM THE
ENVIRONMENT

Anti-Siphon Valve



INTERNAL BALL/SPRING

The gasoline fuel tank feed line that runs from the fuel tank to an engine or generator fuel component uses an anti-siphon valve. The valve is threaded into the fuel tank fitting at the feed line. The valve is pulled off its seat by fuel pump pressure as the engine is cranking or running. There is a ball and spring assembly inside the valve that is activated by fuel pump impulses. It allows a one-way fuel roadway to the engine or generator fuel system. It prevents fuel from siphoning out of the tank in the event of a fuel line rupture or disconnected fuel feed hose. When the engine fuel components stop the fuel from cycling the spring forces the ball against the valve opening to prohibit fuel flow.

Never remove an anti-siphon valve as it is a fuel system safety component. Also, never remove the ball and spring from the valve assembly. The anti-siphon valve requires no normal maintenance. Symptoms indicating possible valve problems may be fuel starvation at intermediate or high rpm or in extreme cases an engine that will not start.

Contact your Regal dealer for further information.

Fuel Gauge & Sending Unit

 **WARNING**

PREVENT INJURY OR DEATH!
READ AND UNDERSTAND THE
PROPULSION AND GENERATOR OWNER'S
MANUAL BEFORE ATTEMPTING
TO OPERATE THE VESSEL.

Fuel Storage On Board

 **WARNING**

PREVENT INJURY OR DEATH!
NO VENTILATION PROVIDED IN STORAGE
COMPARTMENTS. FUEL VAPORS
ARE A FIRE AND EXPLOSION HAZARD.
DO NOT STORE FUELS, FLAMMABLE LIQUIDS
OR PORTABLE FUEL TANKS ON BOARD!

Fuel Filters



Fuel filters are found on outboards under the motor shroud (cover) which should be serviced periodically per the outboard motor manufacturer's instructions. In addition, Regal installs an in-line 10 micron water separator filter

which is a spin on-off type similar to an automobile oil filter. Its main purpose is to trap small dirt particles and condensation (water) in fuel. It is a good idea to keep extra fuel filters on board along with a strap style filter wrench, catch container and clean rags for emergencies. Never use automotive style fuel filters on your vessel. Dispose of all fuel residue materials in an environmentally safe fashion.

These filters are available on-line, through marinas, retail marine outlets, or can be ordered via your closest Regal outboard dealer.

Read and understand the label above regarding the storage of flammables on board the vessel. Also, do not store auxiliary portable fuel tanks on board the vessel since these portable tanks emit vapors into the atmosphere.

Fresh (Potable) Water System

Overview

There is a fresh water supply onboard known as a potable (drinkable) water system. The system includes a 32 gallon fresh water tank/sender, fresh water pressure pump/filter along with various hoses, connectors, fill/vent hardware, faucets, and a monitor panel. We will review the main system components to aid in understanding how the system works.

Note that various components in the fresh water system require periodic maintenance to ensure the system continues to run effectively. Refer to the maintenance section and the various vendor instructions found in the owner's information packet for additional information.

Fresh Water Tank

Normally the fresh water tank is manufactured from aluminum for increased strength and longevity. The tank utilizes a sender which senses the tank water level and displays an approximate amount on the fresh water section of the monitor panel. Refer to the typical fresh water tank components shown in the photo.

Fresh Water Fill/Vent

The fresh water tank fill is normally located on the hull side along with a nearby system vent. Simply remove the cap on the fill labeled “water” and fill with fresh water until you see water exiting through the vent. This tells you the potable water tank is full and ready for use. Tighten the cap when finished filling system to keep debris out of the tank.

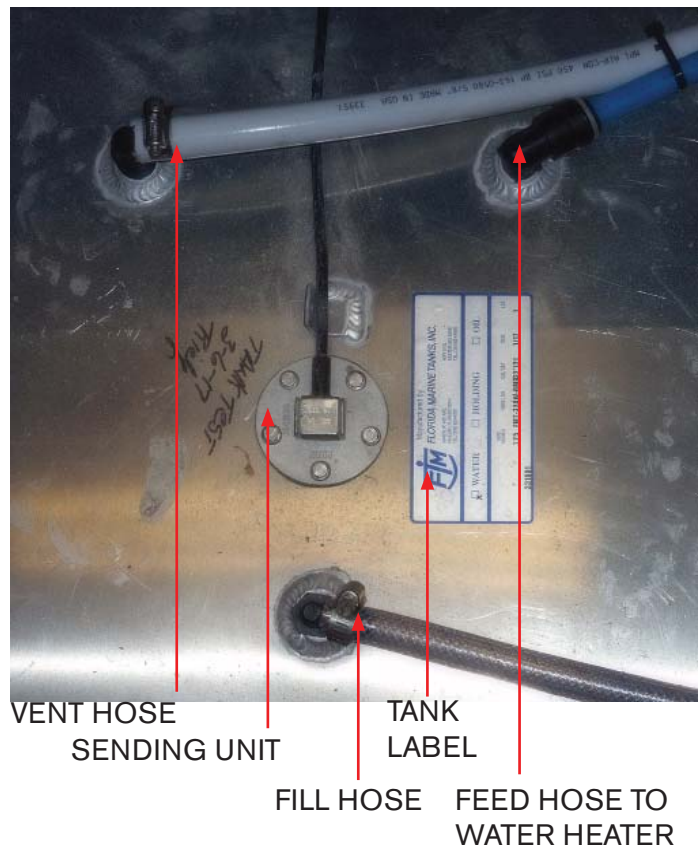

Sending Unit

Note there is a fresh water sending unit located on the tank top. This sending unit measures the amount of available potable water and sends a signal to the monitor panel. When the top portion of the monitor panel switch is pressed the gauge shows the amount of water in the fresh water tank.

This reading is approximate as there is a margin of error involved. Always check the monitor panel fresh water level before each outing or extended cruises.

Fresh Water Feed Hose

The fresh water feed hose runs from the fresh water tank to the fresh water pressure pump. It is normally a blue hose which signifies “cold water”.

Fresh Water Pressure Pump



FILL HOSE FILTER STRAINER PUMP FEED HOSE

Operation

The 12 volt fresh water pump supplies potable water to various fresh water components on the vessel. At the helm panel a fresh water switch controls the wash down hose located under the port gunnel along with sink faucets normally located in the cockpit and head. Also, the transom shower utilizes the fresh water pump. The fresh water switch must be activated for any of the above components to operate.

Note that there is also a raw water pump which supplies water to the bait and fish wells.

Periodically the water filter strainer located near the fresh water pump needs to be serviced. Inside the filter there may be a screen which needs to be cleaned of any debris and rinsed off with fresh water before reinstalling it.

A majority of these pressure pumps use a switch which disengages the fresh water pump after it reaches a predetermined line pressure. If the fresh water pump continues to run continuously it may be a result of the following:

- A faulty internal pressure relief valve
- A faucet on board not turned off
- A broken line or loose line connection

It is recommended that the fresh water pressure pump switch be in the “off” position when leaving your boat to help prevent damage should a leak develop in the cold water system.

NOTICE

AVOID COMPONENT DAMAGE!
NEVER RUN THE FRESH WATER PUMP
WITHOUT WATER IN THE FRESH WATER
TANK AS PUMP IMPELLER DAMAGE
MAY OCCUR.

Using Fresh Water System With Tank Only

This approach is mainly used while cruising without the ability to draw from a marina or public water supply by attaching a garden hose to the city water valve. Also, use this approach when you are unsure of the purity and /or source of the water supply for drinking.

1. Verify through the monitor panel that the fresh water tank is full by activating the upper portion of the toggle switch.

2. At the helm switch panel activate the fresh water system switch. This will energize the water pressure pump to send fresh water from the potable water tank through the cold water lines terminating at the various faucets and related components.

3. Open a faucet. Water pressure should be present. Opening the faucet for a few seconds will purge any air in the system especially in cases where the fresh water tank has run out of water. When water is running at a faucet it is not unusual to hear the water pump activate as it is trying to build up the pressure required in the system. Soon after the faucet is turned off the fresh water pump sound will end indicating the fresh water system is now up to specified system pressure.

Note not to run pressure water pump with system dry as water pump component damage may occur.

 **CAUTION**

**PREVENT PROPERTY DAMAGE!
DISCONNECT
THE DOCK SIDE WATER INLET HOSE
BEFORE LEAVING THE VESSEL.**

Using Fresh Water System With City Water Valve)

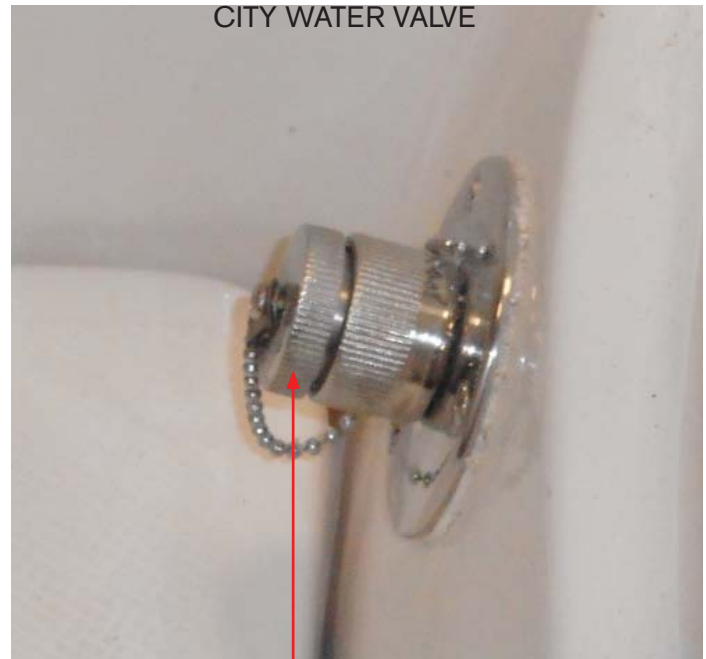

TURN COUNTER CLOCKWISE TO OPEN

Use this procedure when at the dock, mooring or cruising where you know the purity of the water.

1. After verifying that the water supply is safe for drinking find the city water valve at aft transom. Remove the cap and inspect screen for debris.

2. Connect a water system approved garden hose to the city water valve. Turn on the water supply and check for leaks at the connection. White garden hoses are the ones rated for fresh water supply verses a regular garden hose normally leave a rubber smell in the water supply.

2. Repeat steps 2 and 3 as indicated on the last column since the process at this point duplicates itself.

Note that the city water valve protects vessel water system by limiting incoming water pressure to 35 psi's.

Sanitizing Your Vessel Fresh Water System

It is recommended to sanitize your vessel fresh water system at least annually or more often when odors are detected.

1. Flush entire system thoroughly by allowing potable water to flow through it.
2. Drain system completely including water heater.
3. Fill entire system with a chlorine solution having a strength of at least 100 parts per million, and allow to stand for (1) hour. Shorter periods will require greater concentrations of chlorine solutions. See the table.
As a rule of thumb quick reference without the use of the table to reach the recommended proportions use a quarter cup of household bleach for every 15 gallons of water the fresh water tank holds.
4. Drain chlorine solution from entire system.
5. Flush entire system thoroughly with potable water.
6. Fill system with potable water.

TABLE 1 – CHLORINE CONCENTRATIONS

Amount of chlorine compound required for 100 ppm solution

Solution (Gallons)	Chlorinated Lime 25% (ounces)	High Test Calcium Hypochlorite 70% (ounces)	Liquid Sodium Hypochlorite 1% (quarts)
5	0.3	0.1	0.2
10	0.6	0.2	0.4
15	0.9	0.3	0.6
20	1.2	0.4	0.8
30	1.8	0.6	1.2
50	3.0	1.0	2.0
100	6.0	2.0	4.0

Winterizing Your Vessel Fresh Water System

Note that In freezing climates make sure the fresh water system is winterized to prevent damage to hoses and components. Contact your Regal dealer since only special alcohol based products like “Winter Ban” are to be used in the system.

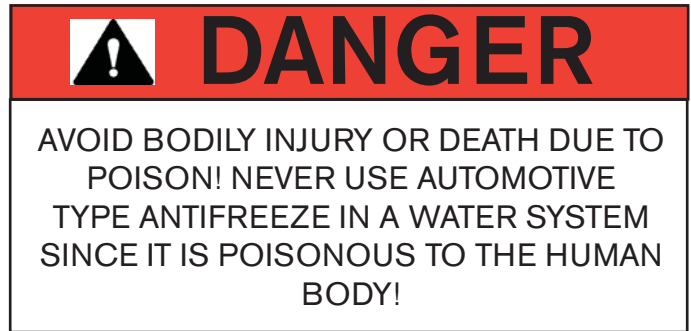

Hot Water Heater

RESET BUTTON

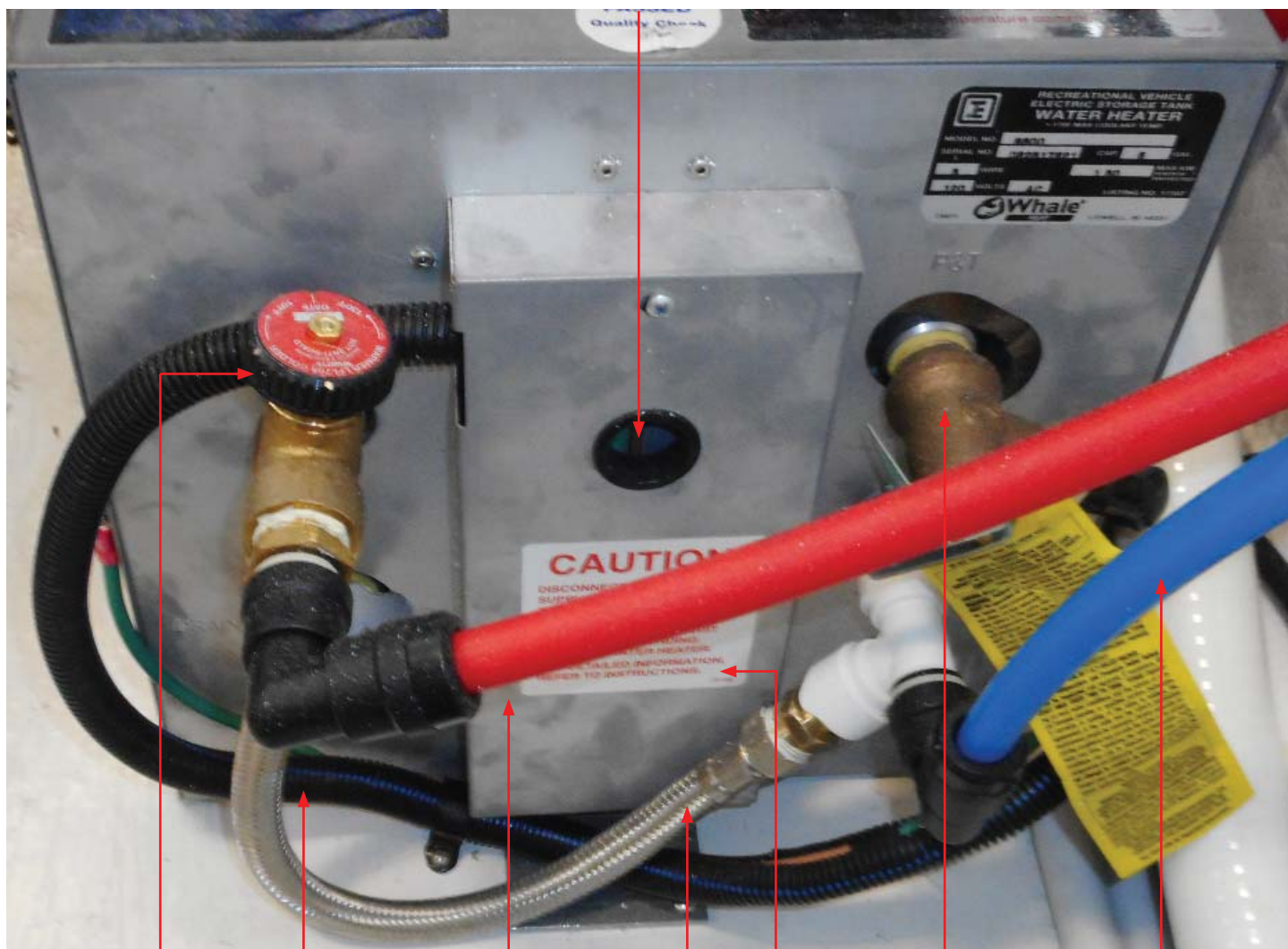

TEMPERING VALVE

HOT WATER FEED HOSE

ELEMENT

T & P VALVE

COLD WATER TO TANK

AC POWER SUPPLY

TEMPERING VALVE COLD WATER FEED HOSE

OVERVIEW

The ship's water heater requires 120 Volts AC and the unit is located in the sump (bilge). The water heater breaker is located on the main ship's AC panel. It offers a 6 gallon capacity. The unit draws cold water from the fresh water tank and is heated by using dock side power or by the generator at sea. *Note that the water heater does have a limited hot water capacity. People on board need to be aware of that fact. It pays to conserve!*

OPERATION

The photo above displays key players in the operation cycle of the hot water heater.

The cold (blue) water line transports water from the fresh water tank to the aft tee on the water heater. Water runs through the tank via a tempering mechanism and exits the hot (red) line to the hot side of each sink and to the head shower mixing valve.

Notice the brass T & P valve in the photo. This is a safety device for the hot water heater. Your home hot water heater uses a similar product. Should water reach an unsafe temperature or excess pressure a lever opens to exit the water and steam through a hose overboard. Most valves will activate with pounds per square inch over 150 and water temperatures exceeding 210 degrees. The T & P valve lever should be activated manually once a year to ensure hot water and steam will vacate through the discharge hose.

The tempering valve is attached where the hot water exits the hot water heater for travel to the sinks and shower. You can identify the valve by the red knob on top. Make a note of the tempering valve setting and make sure it does not change. The purpose of the tempering valve is to regulate the outgoing heated water to a maximum of 125 degrees. If the output water is of a higher temperature than specified the valve mixes cold water to decrease out going water to safe levels through the stainless steel mesh hose.

There is an element located inside the rear cover of the hot water heater. This is the component that heats up the water inside the water heater. The element requires that it be immersed in water or it will quit functioning. There is a reset button for the element which can be accessed through the hole at the rear casing. Push in to reset the button.

 **CAUTION**

**PREVENT HOT WATER HEATER DAMAGE!
NEVER ACTIVATE THE BREAKER
WHEN THE HOT WATER HEATER
IS NOT COMPLETELY FULL OR
THE ELEMENT WILL BE DAMAGED!**

Fresh Water System-Helpful Hints

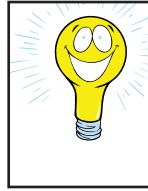

1. Fresh water pressure pump cycles on and off. Normally this type of action indicates a water leak in the system. Check all fresh water system related equipment on the deck, cabin, and engine compartment for leaks. Do not forget wash down equipment including spigots. Look for puddled or dripping water.
2. Using potable water system the water pressure is weak. Check the fresh water pressure pump filter for debris. Also, make sure the potable water tank level is sufficient at the monitor panel.
3. Water at sink or shower is hammering and has air bubbles in it. Check for air leaks in the system along with low water levels in the potable water tank.
4. Water is backing up in the shower. Find the shower sump pump. If it is full of water even when running there may be a clog at the pump screen. Clean as needed.
5. There is no water at any of the fresh water related equipment such as faucets, showers and wash downs. Check to make sure the fresh water pressure pump breaker is on. Also, check the fresh water monitor for tank levels
6. The water system has a bad odor. Use the fresh water pressure pump to drain the fresh water system. Do not drink the water as it may be contaminated. Sanitize the water system.
7. No hot water. Check panel breaker. Check for popped tank element breaker. Reset as needed.

Waste System (Typical)

Overview

This section covers the main components of the standard waste system. Note that your vessel may have other components that are not covered in this section. Refer to the vendor owner's manual located in the owner's information package or consult the internet or your closest Regal dealer for details regarding optional equipment.

The main standard components of the waste system are the toilet, holding tank, monitor panel along with hoses, fasteners and sea cocks. We will explore each in this section.

Typical Head (Toilet) System

The onboard style head system features a vacuum toilet using minimal water. It normally features vitreous china bowls, minimal maintenance, easy cleaning and a wall switch keyboard.

The toilet is powered by 12 volt DC current and is controlled by a 30 amp breaker located at the ship's battery management panel. After opening the panel door remove the four safety hub retainers to access the fuse behind the cover plate (Type AMI/MIDI).

These fuses are ignition protected, tin plated for corrosion resistance, and available at marine retailers & automotive stores.

Under normal conditions, the head system operates from the onboard freshwater tank. If dock side water is being used the toilets still draw water from the freshwater tank.

A Few Notations About Marine Toilets

Only human waste and toilet paper should be put in the toilet. Never flush foreign materials such as paper towels, pre-moistened wipes, condoms, feminine hygiene products, dental floss or household garbage down the toilet.

- Always disconnect the dock side water system if boat is left unattended to avoid property damage due to leakage.
- Refill the toilet as soon as possible after emptying the bowl to prevent objectionable odors.
- Use only RV-Marine toilet tissues that disintegrate rapidly. Do not use household type tissues.
- If repairs are needed, use only a trained and qualified marine technician or electrician.



VACUFLUSH STYLE HEAD

BATTERY MANAGEMENT PANEL



Operating Vacuum Style Toilet

To use toilet first make sure the 12 volt breaker is activated at the main control panel. Remember even though you are using dock side water the heads draw water via the fresh water system through the potable water tank.



The wall control switch is used to add water to the bowl and to flush the toilet. Select cycle information is noted here. For more complete information, refer to the toilet vendor information located in the information packet.

1. To add water (est. 17 ounces each cycle) to the bowl press the add water button momentarily and release. The system prevents overfilling the bowl.

2. To flush the bowl press the flush button momentarily and release. The attached bowl motor will macerate the waste and flush it. The cycle ends with a small amount of water being added to the bowl to help prevent odors. This completes the minimal water usage flush cycle.

Wall Control Panel Blue Backlighting Description:

- The holding tank icon in the lower right hand corner of the control panel is not lighted. Toilet system is off or not receiving power.
- The holding tank icon is normally green. This means the holding tank is less than full.
- The holding tank icon is red. The holding tank is full or near full with the flush lockout (prevents Flush operation when holding tank is full) activated.
- Tank icon flashes.
- Sleep mode (non-use for 8 hours) causes the lights to go out. Pushing the fill or flush button momentarily will return lighting cycle.

Single Flush Override of Flush Lockout

1. If the holding tank is full the flush lockout cycle will not allow the bowl to be flushed and the flush button will be lighted red.
2. For emergency use only the flush button can be held for 8 seconds and a flush will occur. This can be accomplished because the full sensor connected to the holding tank is usually placed a bit below the actual full capacity of the tank. Flushing more than 5 times using the override feature may force waste into plumbing system. Regal is not responsible for damage to equipment, injury or death due to overflow of waste when flush lockout is overridden.

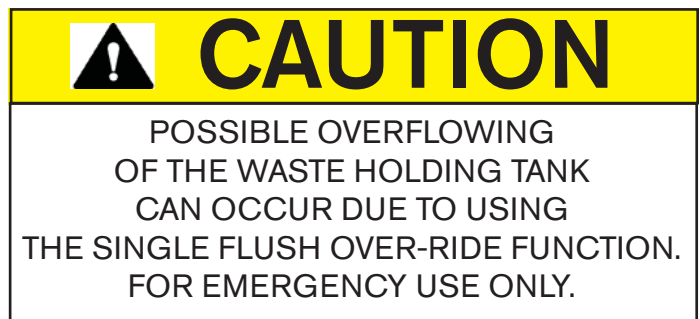

Monitor Panel



KEY GAUGE MOMENTARY SWITCH
PUMP-OUT BUTTON

The monitor panel is found in the cabin above the ship's main AC panel. It is a multi-function component but also offers a check for the potable water and waste tanks. To check the waste tank black water level press the lower part of the momentary switch shown in the above photo and check the gauge.

It will help you determine when to pump out the waste tank. The top segment of the switch measures the fresh water tank level. Check levels before each cruise. Pump out waste and fill potable water tank as required.

Waste Tank

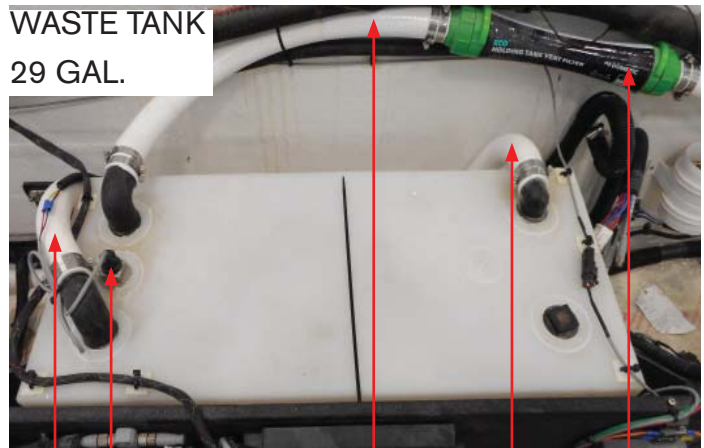

WASTE TANK
29 GAL.

SENDER VENT HOSE
HOSE FROM TOILET FILTER

HOSE OUT TO PUMP OUT/ OPT.
OVERBOARD DISCHARGE

Overview

The waste water system on your vessel is located in the sump. The system features a pump-out fitting mounted on the deck labeled waste.

A monitor panel shared with the fresh water system displays the waste tank level when activated. Press the lower portion of the switch and read the gauge waste level. The waste tank can be pumped out at select marine facilities. Normally a hose is attached to the deck waste fitting and the tank waste is then pumped into a dock side facility storage container.

After the pump out procedure it is always a great idea to use a garden hose to rinse the pump out hose before recapping the waste fitting. This will help keep residue from building up in the inside of the waste hose.

Overboard Discharge

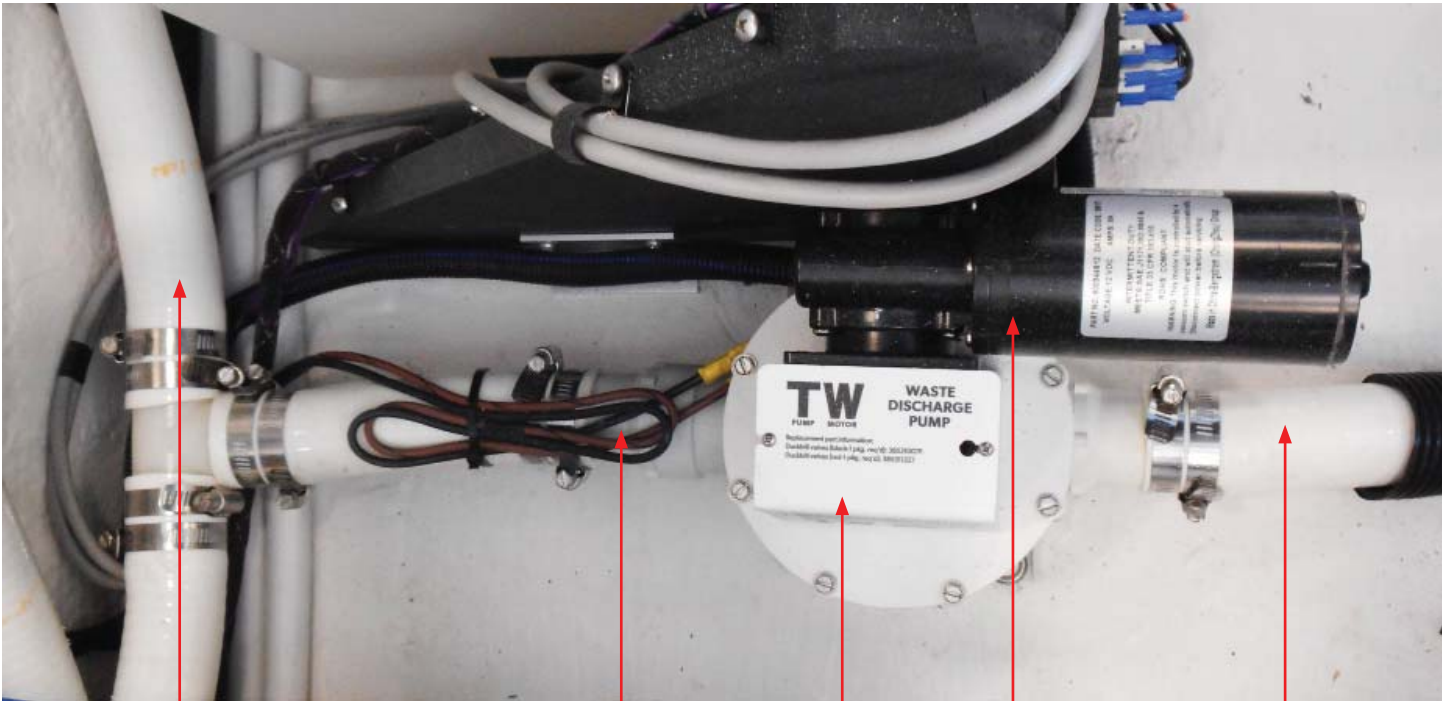

HOSE-TANK TO PUMP OUT HOSE TO OVERBOARD DISCHARGE PUMP MACERATOR DISCHARGE PUMP HOSE TO SEA COCK

Operation

As an option the vessel may be outfitted with an overboard discharge system including macerator. Waste will exit the hull through the macerator sea cock turned to the open position.

To pump overboard notice there is a key switch and red button on the monitor panel. Turn the key to the "on" position. Next, press the red button and hold it as the macerator pumps the waste through the hull bottom sea cock. Check the waste portion of the monitor panel as the gauge should show empty. The reset breaker on the monitor panel protects the power to the gauge. The macerator grinds up the waste and sends it through the hull bottom via the open macerator sea cock.

See the photo at top of page 106.



MACERATOR SEACOCK THRU HULL BOTTOM

The macerator breaker is 10 amps and is located behind the battery management panel and safety hub cover. After pumping out, the sea cock handle must be turned to the off position and tie wrapped closed.

Check for all local and state laws regarding pumping overboard domestically before attempting to open the hull bottom sea cock as there may be stiff fines for pumping illegally. It is legal to pump overboard outside the United States 3 mile limit.

Periodically check all hose clamps for tightness, hoses for cuts, and abrasion and that all components are fastened securely.

Vent Filter



The waste (holding) tank filter is in-line between the holding tank vent and in this case a transom exit (exit hose missing here). As the holding tank fills up with waste it gives off odors. The vent filter breaks down the odors while they travel out the aft portion of the transom.

The waste filter is “customer friendly” as it is designed with a union at each end for changing out the filter. The unions unscrew counter clockwise for serviceability. It is recommended to change the filter yearly, normally at the end of your boating season. Mark the change date on the filter or on your vessel maintenance calendar.

It is a good habit to carry an extra filter onboard. For further information on availability contact your closest Regal dealer or maine retail outlet.

Open the overboard discharge (macerator) sea cock before attempting to pump waste overboard. To pump overboard note that there is a key switch and red button on the monitor panel. Turn the key to the “on” position. Next, press the red button and hold it as the macerator pumps the waste through the hull bottom sea cock. Check the waste portion of the monitor panel as the gauge should show empty.

The reset breaker on the monitor panel protects the power to the gauge.

Shower Box

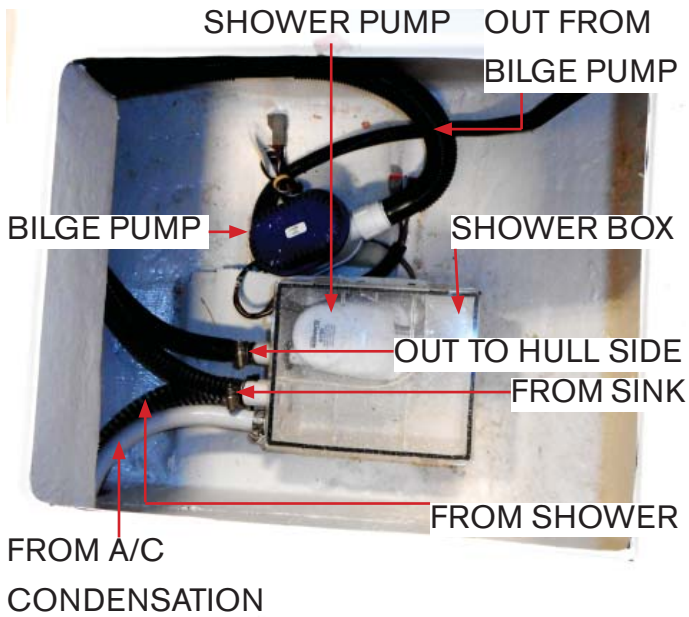

The shower box is a collection and distribution point for much of the water used in the vessel's sinks, shower, A/C system and bilge pumps. This used water is pumped overboard traveling from the shower box to a hull side fitting.

Periodically check the shower pump inside the shower box for debris buildup at pump grate.

Also, note that the forward bilge pump is positioned close to the shower box. It is a good idea to check the automatic pump next to the bilge pump to make sure it is free of debris. If you lift the automatic switch you should hear the bilge pump start to run.

CO Detectors



Carbon monoxide known as CO is indeed the silent killer. It is a by-product of combustion. CO is invisible, tasteless, odorless and is produced by all combustion engines, heating and cooking appliances.

The most common forms of CO on board vessels are petrol engines/generators and if applicable, propane heating and cooking devices. Note: Even though your vessels propulsion system is diesel based follow the CO precautions. Also, remember that a vessel moored next to you may be a CO poison contributor.

Never operate these devices when people are sleeping. A slight amount of CO in the human body over several hours causes headaches, nausea and symptoms close to food poisoning, motion sickness or flu. High concentrations can be fatal quickly.

How System Works

The CO detector uses a mini computer to measure and accumulate CO levels. Using the principle of “time weighted averaging” the detector monitors CO concentrations, temperature, humidity and time to calculate COHb levels. To explain COHb, our bodies prefer to absorb CO to oxygen and COHb is the absorbed ratio stated in a percent.

If the detector senses high levels of CO the alarm will sound in a few minutes. If lower levels are sensed, the detector will accumulate the data and sound an alarm when the appropriate level is reached. Read and understand the CO owner’s manual in the information pouch.

The CO circuitry works to its best performance when continually activated plus it accords advanced warning when entering an area high in CO.

The CO detectors operate using 12 volt DC power and over current protection inside the battery management box in the engine compartment.

The test cycle should be activated frequently. Simply press the button. Refer to the CO detectors owner’s manual for an explanation of the test cycle indicators.

Note that the green light will flash every 180 seconds which is normal.

When an alarm sounds take action immediately. The danger alarm indicator flashes red and the horn beeps 4 times, pauses and repeats the cycle. This indicates a rate of 10% COHb has been reached.

- a. Operate reset/silence button.
- b. Call your emergency services (911)
- c. Immediately move to fresh air. Do not re-enter the vessel. until emergency personnel have arrived, aired the vessel out and the alarm is in a normal condition.
- d. After following steps a-c and your alarm re-activates within a 24-hour period call a qualified technician to inspect the vessel. Note that the CO detector will clear when the CO concentration has dropped below 70 ppm.

Fishing Systems (Items may be optional)

Bait Well/Live Well

The bait well sometimes referred to as a live well features a capacity of approximately 8 gallons. The bait well darker color decreases shadows on the tank walls which reduces bait stress. The rounded design helps the bait to maneuver better inside the bait well prolonging bait life.

Constant sea water is supplied by an air control center featuring a bait well pump and drain which promotes a self-draining cycle to ensure constant water circulation and oxygen for the bait. A clear bait well cover with latch and seal keep the bait and sea water contained while cruising to your fishing location. Also, the clear cover enhances monitoring. There is an aft sea cock that supplies sea water to the bait well through a 500 GPH pump located at the top of the sea cock. There is a manifold opening on the sea cock body that provides sea water for the port gunnel sea water wash down with nozzle. Notwithstanding the bait well includes an LED white light for night fishing use. The bait well switch is mounted above the cockpit refrigerator.



Hints For Bait Well/Live Well Wellness

1. Never use soap or bleach to clean a bait well or live well. Use fresh water alone to avoid harmful residues.
2. For large delicate baits like menhaden, stick to one bait-per-gallon formula. Do not overload.
3. As much as possible, avoid handling baits with bare hands. Use a de-hooker or bait net instead.
4. If possible, always fill a bait well with water where the bait was caught.
5. During hot summer days use small sealed bags of ice in the well to help lower water temperatures without contaminating the water.

Fish box Features

Your fish box is integrated into the aft cockpit floor. It features a hatch and a generous capacity for keeping the big catch until you return to port. Vessels without the optional Seakeeper boast an estimated 25 gallon capacity. Seakeeper option boats contain an estimated 12 gallon capacity fish box. There is a vent near the top of the fish box side that keeps a vacuum from forming with the hatch lid latched while the optional macerator pump is energized. Do not cover the vent.

The optional fish box macerator style circulation pump is installed in the aft sump (bilge) close to the battery set. The fish box switch is mounted above the cockpit refrigerator. Following are tips on making the best use of your fish box in keeping your catch fresh.



Bait Well/Fish Box Switches

Fish Box Usage- Hints/Tips

Be sure to rinse out the fish box before using fresh water. Do not use bleach or soaps.

Place ice in the fish box. Pack down the ice several inches to provide a safety zone between the ice, catch and future melting ice (water). Close the lid. Note that the lid features a seal to keep the temperature inside the fish box cooler. As fish are caught layout in the cooler and quickly cover with a layer of ice. Layer fish and ice as other fish are added to the fish box. Periodically monitor the box and remove any melted ice (water) using the fish box pump. Do not let the water get to the level of the fish as it will cause the spoilage process. Add ice to keep the catch well covered especially during the run to port. Avoid over opening the fish box since this will melt the ice and raise the box temperature. Try to avoid rough handling or crushing the catch since bruised fish can alter the taste of the meat.

After the fish are removed from the box the pump can be run to exit ice, fluids and fish debris from the unit.

Then rinse the unit with lots of water using the fresh water wash down at the gunnel (top hose).



TYPICAL FISH BOX

After the fish are removed the fish box pump can be run to exit melted ice, fluids and fish debris from the unit. Also, the fresh or raw water wash down can be used as needed for the cockpit floor, live well or fish box compartments for rinsing off debris.



Note that the nozzle sprayers are adjustable for a variety of spraying solutions. As you use the raw water wash down the intake is through the hull bottom sea cock. Thus water quality is questionable.

Rod Holders



TYPICAL ROD HOLDERS



If installed, rod holders are located on the port and starboard gunnel and/or may be located on the transom.

The gunnel rod holders are 316 grade stainless for durability and heavy duty fishing. They can be used in conjunction with the optional Top Gun Outrigger system. The fishing rod sits at an aft angle in the rod holder while the outrigger controls the pole line, holds the bait and keeps the line out over the water while the boat is making headway. For trolling purposes the fishing rod handle rests down inside the rod holder. The gunnel rod holders also serve as cup holders.

If installed the transom mounted rod holders are useful for carrying a variety of fishing poles with different pound line and outfitted for catching specific fish. The transom rod holders provide a quick and easy way to change out the fishing gear.

Outriggers (Option)



Outriggers Overview

If installed on your vessel outriggers are used mainly for trolling. The twin outriggers accommodate individual fishing pole rigs on each side of the vessel.

Note that the outrigger nylon line must be attached between the outrigger pole eyelets, snap swivel and deck camel back, and bungee cord assembly with pulley. Once the vessel is making headway the fishing pole line is baited and attached to the outrigger clip hardware at the extension poles. Then the tensioning nut on the end of the outrigger is set. Once this is done with the fishing pole resting in the rod holder the fishing line is left to unwind while the outrigger is positioned and the line distance is achieved. At this point the correct drag adjustment can be set on the fishing pole reel. When a fish "strikes" the line is released from the outrigger clip and the fish is retrieved with the fishing pole.

If installed, refer to the outrigger information found in the owner's information satchel which will help keep your outriggers in top condition.



Outriggers Collar/Handle Usage

Below is basic operation data for using and positioning the outriggers. More further information refer to the vendor instructions in the owner's information packet.

In the swivel position the outriggers are positioned side to side (trolling position). To swivel the outriggers unlock the latch by swinging up 180 degrees as shown in B. Now turn the handle completely counterclockwise to release it from the detent position.



In the storage position the outriggers are positioned fore to aft on the hardtop with the handle and base collar as shown in A. The latch is in the locked position along with the swivel handle in the detent locked position. This is the recommended position for highway towing or at the dock after a day of trolling for fish.

While holding the handle in the released position, rotate the entire assembly until it stops in a detent. Tighten the handle. Lock the latch. See C. The outriggers should now be in the trolling position ready to attach the fishing pole baited line. Periodically inspect outriggers for missing or worn hardware. Replace as needed.

Chapter 5

Outboard Engine & Controls

Regal Owner's Manual

It is important that you read your outboard engine manual carefully and become completely familiar with the operation as well as necessary maintenance on the engine and propulsion systems. Pay careful attention to the sections on winterization if you live in freezing climates. Extensive damage can result if proper winter storage is not followed in freezing climates. Contact your Regal dealer for information regarding technical issues and parts. Also, refer to the maintenance section of this manual.



WARNING

PREVENT INJURY OR DEATH!
READ ALL MANUFACTURER'S OUTBOARD
ENGINE AND PROPULSION OWNER'S
MANUALS BEFORE OPERATING
YOUR VESSEL.

This chapter is intended to give general information about the location and function of typical outboard engine and controls. Control systems and engines may vary from model to model. Refer to the specific engine owner's manual for your equipment that would include the following information in greater detail.

Engines function is based from four principles; fuel, compression, ignition, and exhaust. The proper ratio of fuel and air must be drawn into the engine's cylinders in order to be compressed by the pistons and ignited by a spark the force of which pushes the piston back down, providing the energy used to turn your propeller, before the engine kicks into the exhaust stage where it expels the by-products. If any of these four functions fail, so does the engine itself.

Beyond these basic concepts of engine functionality include engine cooling, lubrication, and electrical systems. The specific details of these systems can be found in the outboard manufacturer's owner's manual for the specific engine option you chose on your Regal boat.

Engine Removal

In the event the outboard engine needs to be removed from the transom consult your Regal dealer. He has the factory trained knowledge and equipment to remove the engine safely and efficiently.

Engine Checklist Before Each Outing

Every engine option may require different checks before each use, but a general engine checklist is included here as a guide.

- Check crankcase engine and gear case oil levels.
- Check steering fluid.
- Check power trim fluid.

At Helm/ Deck

- Check power trim for operation.
- Check control lever for operational defects. Check the clip and safety lanyard for functionality.
- Check gauges for accuracy.
- Check fuel level and ensure the level is sufficient for the trip with a reserve.

Engine Cooling System

Your typical engine normally utilizes a raw water system for cooling the engine with intakes at the gear case. It is important that this system continues to run unobstructed at all times to avoid hazardous situations and to ensure a safe voyage.

Raw water is drawn up into the outboard vertical drive shaft housing through pick-up feeds in the gear case vicinity.

Water passes through a power head thermostat which controls how much water circulates through the power head. The cool water absorbs heat produced by the engine, before being emitted via the coolant exhaust system.

There is a access hole on the port side of the power head which shows a visual stream of water at all times. If no water is visible with the engine running shut down the engine and investigate the problem. At times this relief hole can be plugged by debris.

Impeller/ Water Pump

Periodically, the coolant system's impeller and water pump should be inspected for debris, damage or excessive wear due to use, water chemistry such as mineral and/or silt conditions. Damaged parts will affect the system's ability to function, and may cause engine overheating or damage. Contact your closest Regal dealer for more information and maintenance schedules of key outboard engine systems.

Thermostat

If the temperature gauge starts yielding abnormal readings, it may become necessary to look at or replace the power head thermostat after determining whether it is functioning properly. The thermostat reads the temperature of coolant and determines whether to open or close a valve to allow warm sea water to pass into the exhaust manifold. The thermostat may recirculate hot coolant for the purposes of reaching standard operating temperatures.

If standard operating temperatures have been reached, the thermostat will open a valve and allow hot raw water to exit through the exhaust manifold. For more information read your outboard engine manual or contact the closest Regal dealer. Dealers have the necessary knowledge and tools to troubleshoot any engine related problems.

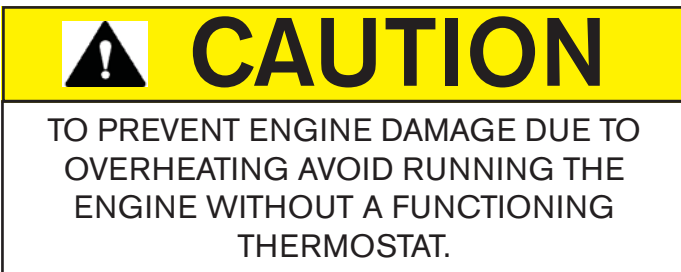

Freshwater Flushing Attachment

Your outboard features a fresh water flushing system. After linking up to a fresh water hose at the flush port, water can be pumped through the engine's raw water cooling system to flush out all salt and debris that may be left behind. Normally there is a hose thread fitting on the side of the engine. After the connection is opened a garden hose is connected to the fitting and the engine can be flushed. It is best to connect the flushing system up when the engine is warm since the thermostat is open at this time to allow water to circulate through the entire head rather than bypassing the cylinder head areas. Do not run the engine while using the flushing device as engine damage may occur.

Engine Electrical System

Your engine utilizes a great deal of electronic equipment. Some equipment sends signals between the engine and the Garmin, while other systems set off alarms, and still others are used by the engine to generate a spark and ignite the fuel. The battery switch controls electrical power distribution to the boat systems.

To regularly maintain your DC electrical system, inspect the battery charge before each trip. Test all gauges and control equipment prior to departure, and replace as necessary. Spark plugs should be replaced according to your engine owner's manual maintenance schedule.

Gauge Electrical Signals

Your outboard transmits signals through electrical harnesses to different components through the use of NMEA 2000 connections and a "backbone system". A standard Garmin plotter displays the engine functions. The fuel gauge and depth sounder use stand alone technology to display readings. Also, idiot lights are display tolerances that are classified as being abnormal.

Alarms

When a malfunction with your outboard engine occurs, the Garmin plotter alerts the skipper of a problem. Common engine problems include overheating, low oil pressure, or a miscommunication with equipment. Learn the alarm systems that apply to your engine by consulting your engine owner's manual.



CAUTION

AVOID ENGINE DAMAGE OR FAILURE!
DISCONTINUE ENGINE OPERATION
AFTER AN ALARM HAS SOUNDED.
ADDRESS MALFUNCTION BEFORE
RESTARTING ENGINE.

Spark Plugs

The spark plugs are the piece of equipment that help make ignition occur. As electrical potential builds on one side of the gap based upon the energy distributed by the distributor, the potential eventually grows large enough to cause the electric current to jump the gap on the spark plug. This spark is what ignites the compressed fuel generating a controlled explosion that will power the piston down and deliver power to the drive shaft.

Stator

Under normal circumstances, the starter battery would wear down after being used so often to generate a spark for the engine. This isn't an ideal setup because a strong battery is needed for continual operation. A weak battery does no good out on the water. The stator recharges the batteries while the engines are running.

However, in an effort to conserve battery life, the battery switch should still be turned off after every trip and turned on at the start of every trip. This limits the drain on the battery while the boat is not in use. As standard equipment a battery charging system charges batteries while the dock side cord is hooked up. It is a 40 amp charger.

Fuses

Your engine also comes equipped with fuses that will burn out or “blow” when engine components attempt to draw more power than the piece of equipment or wiring can handle. When the fuse blows, it breaks the circuit, and electricity stops flowing. Before replacing the fuse, investigate the cause of the problem, and why the equipment was overworked. Your outboard engine uses a helm mounted fuse box which is accessible by lifting the starboard bow backrest while others feature in-line fuses, while still others feature a mixture of both. Refer to your outboard engine owner's manual for complete details on your electrical system and the location of any engine mounted over current protection.

Engine Exhaust System

Your engine expels the by-products of the engine operation through an exhaust system, just like cars do. In boats however, this exhaust system mixes the debris left over after the power stroke of the engine with the hot water that is expelled after cooling the engine.

Basically the exhaust flows through the power head before expelling the exhaust through the vertical drive housing either just above the propeller, or through the prop shaft.

Engine Fuel System

Refer to the system chapter of this manual for fuel system specifics. Be sure to read and understand the following warnings.



WARNING

USE OF ALCOHOL ENHANCED FUEL, OR ANY FUEL OTHER THAN GASOLINE CAN LEAD TO DETERIORATION OF THE FUEL SYSTEM COMPONENTS. THIS CAN RESULT IN FIRE AND POSSIBLE EXPLOSION.



WARNING

GASOLINE VAPORS CAN EXPLODE!
BEFORE STARTING ENGINE
CHECK COMPARTMENTS AND MOTOR WELL
FOR GASOLINE LEAKS OR VAPORS.



WARNING

PREVENT INJURY OR DEATH
DUE TO FIRE OR EXPLOSION!
RUN GENERATOR BLOWER AT LEAST 4
MINUTES BEFORE STARTING GENERATOR.

Engine Lubrication System

Whenever two components rub together, friction causes wear on both components. To minimize the wear on your engine, a lubrication system has been put in place to help components slide next to each other easier. This is particularly important within the inner workings of an engine. It is important to ensure your lubrication system is working properly at all times.

Your Regal utilizes lubrication and fluids that need regular check ups. Refer to your outboard engine owner's manual for specific details regarding the proper maintenance of the lubrication system.

Note that your outboard uses other lubricants in addition to engine oil such as power trim fluid and prop shaft gear case lubricants to reduce wear on moving components. These fluids should be checked according to the recommended maintenance procedures determined by the outboard manufacturer.

Engine Oil

The purpose of engine oil is to lubricate the internal components of the engine and ensure that parts that regularly move against each other have reduced friction to lessen wear and noise between components. An oil filter keeps metal particles and water out of the engine's interior.

Yamaha engines performing on regular oil should have the oil drained and replaced after the first 20 hours of operation or 3 months, and every 100 hours or at 1 year intervals thereafter.

Gear case Oil

Gear case oil keeps all the mechanical components of the prop shaft gear assembly functioning optimally. It reduces friction in the gear case as the gears revolve. Sometimes gear case oil is called gear lubricant. Gear case oil should be inspected periodically according to factory maintenance schedules. Use outboard manufacturer's recommended oil.

Power Trim Fluid

Power trim fluid allows your outboard to trim up or down. This is particularly useful when trying to get your boat to plane.

Power trim fluid is used in hydraulic rams that maneuver the outboard unit. Power trim fluid should be checked regularly in the reservoir which is located in the bilge.

Propeller System

Regal has carefully tested and chosen the propellers to give your outboard boat the best possible performance based on the engines and propulsion package you choose. We have allowed for the additional weight in equipment that might be added to the boat. It is a good idea to carry a spare set of propellers and hand tools onboard in order to handle emergency propeller changes.

Each Yamaha propeller displays the following information:

1. Propeller pitch shown by inches.
2. Propeller type (L for left or R for right).
3. Propeller diameter in inches.

Your Regal features twin outboards. The port engine rotates counterclockwise and uses a left hand propeller. The starboard engine rotates clockwise (standard) and uses a right hand propeller. Read and understand the label below.

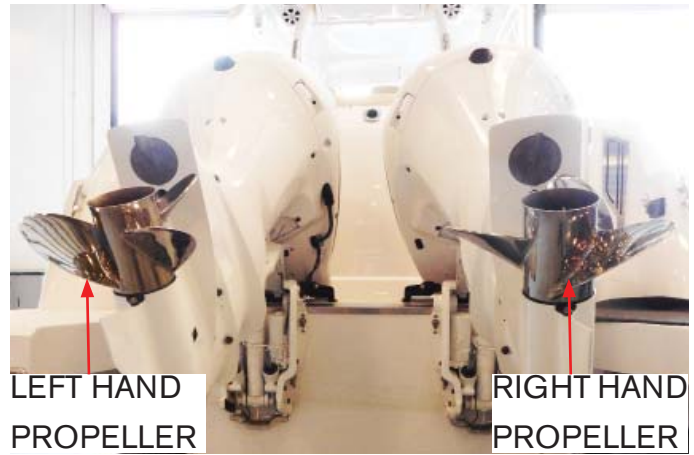

Refer to the outboard manual for procedures, as the application is unique to the manufacturer. Call a marine professional or your Regal dealer for to order a spare propeller set.

Propeller Checklist

At least twice a year, check the propeller for:

- Loose, missing, or corroded hardware.
- Nicks, dings, or missing propeller material
- Bent propeller blades.
- Objects wrapped around the prop (fish line)
- Decomposing propeller blades (electrolysis symptom).
- If equipped, check the propeller rubber hub for slippage

Contact a propeller shop or your closest Regal dealer if any of the above symptoms exist. They have purchased special equipment to refurbish both stainless steel and aluminum propellers.



WARNING

AVOID A POSSIBLE ACCIDENT!
NEVER USE A STANDARD PROPELLER ON A COUNTER ROTATION ENGINE, OR A COUNTER ROTATION PROPELLER ON A STANDARD ENGINE. THE VESSEL COULD GO IN THE OPPOSITE DIRECTION EXPECTED FOR EXAMPLE (REVERSE INSTEAD OF FORWARD)

Helm Systems

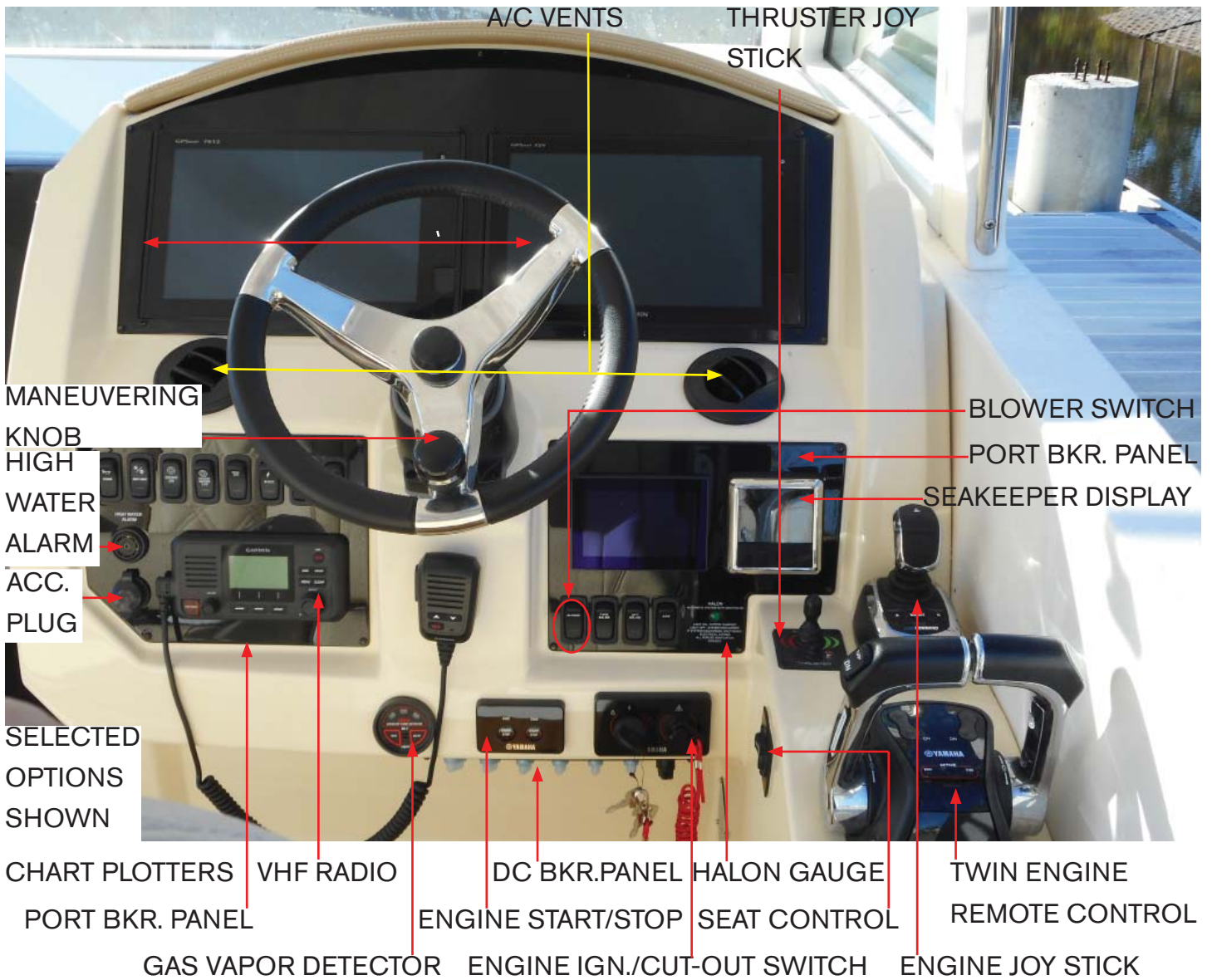

Helm Overview

The helm station is equipped with the ability to monitor engine functions through a Garmin chart plotter. Close observation of the digital display is recommended throughout the trip as you can split the screen to accommodate GPS functions along with monitoring basic engine systems including fuel usage and hours for maintenance cycles. This works in addition to the outboard engine manufacturer's alarm system.

Obviously with the dual chart plotter option another whole dimension of information monitoring is achievable. Note that with the battery switches in the "off" position, there is no power to the helm and the ignition switch will not function.

All electrical features are protected by the main battery management panel located in the sump. Refer to the systems chapter for additional information.

Garmin Engine Monitoring Display



Typical Display Shown

A Garmin chartplotter is standard equipment on your outboard vessel. The unit displays many GPS features along with the ability to monitor engine system functions including engine revolutions per minute (rpm's), GPS speed, voltage, fuel flow rate, trim, and temperature along with tracking engine hours.

Fusion uses its own display screen on the chartplotter for audio controls on the vessel.

Note that the Garmin and Fusion circuitry use individual DC sources to power up the system. The key switch does not power up these 2 systems.

1. To power up the Garmin GPS activate the electronics breaker on the panel. Next, press the on button located at the upper chartplotter display.
2. The function AV/Gauges,Controls will appear as one of the choice boxes. Press the box. Another screen with engine will appear.
3. Press the engine box and the engine gauge displays will appear (oil pressure is engine code driven only).

Helm Switch Panel-Port



The port helm switch panel controls various vessel electrical components. The main battery switch must be activated for most of the switch functions to work except for the automatic side of the aft bilge pump.. Below is a brief description of each switch. Note that select switches may represent optional equipment that is not installed on your vessel.

Horn

This momentary switch controls the electric horn located at the starboard bow area. Make sure the horn is tested before each outing as it can be valuable in navigation situations and can be used for bridge communications. Normally there is an adjustment screw on the horn top to alter the horn tone. Periodically inspect the horn hardware for tightness and polish the horn grill located on the outside hull side.

Nav/Anc

This on/off/on switch energizes the center bow red/green navigation light and stern light as a standard configuration as the top portion of the switch is pressed.

When the bottom portion of the switch is activated the anchor light all-around portion illuminates on the hard top. Check navigation lights before each outing to ensure the bulbs are working properly and the wiring circuitry is delivering current to the light fixture.

Cockpit Lts

This switch controls the blue LED lighting which is normally found on vertical surfaces to aid in nighttime cockpit activity. They are especially useful to light stairways, deck walkways, and swim platforms.

Underwater Lts

This switch controls the hull mounted underwater lights. If installed these blue LED lights illuminate the water around the aft sides and transom areas.

Fresh WTR

This switch energizes the on board potable fresh water system. It permits the water pump to draw fresh water from the potable water tank to any faucets or showers mounted aboard along with the toilet. The gunnel mounted fresh water wash down is part of the fresh water system. This switch covers the use of the city water system when hooked up to the city water pressure valve dock side.

Elect.

The electronics switch controls the NEMA system of which allows the outboard gateway to communicate or “talk” to the chart plotter and transducer. It also controls the “fuel insect” which

connects the fuel tank sender wire to the Garmin chip to read the vessel fuel tank level.

Windshield Vent

This switch controls the hard top center window vent. When activated it drives a mechanism to control fresh air.

Wiper

This switch controls the optional starboard windshield wiper. Do not run the wiper blade over dry glass as it can leave permanent scoring on the windshield. This system will park the blade in the down position. Periodically check the blade for wear.

Helm Switch Panel-Starboard



Blower

This switch controls the DC powered blower at the bilge starboard hull. It removes any gasoline vapors from the bilge compartment.

Always run the blower for at least 4 minutes before starting the generator. Keep the blower on during generator usage.

Fwd. Bilge Pump

This switch covers the forward bilge pump. This pump is located below the cabin steps under the floor hatch. It is close to the shower box. Periodically check the pump float mechanism to ensure it is activating properly and the pump grate for debris.

Aft Bilge

This switch controls the aft bilge pump which is located below the Lazarette compartment storage hatch in the aft cockpit.

Acc.

This switch controls the air conditioner system.

Helm Breaker Panel



Horn

This breaker protects the horn module located near the anchor locker.

Spot Lt

This breaker protects the remote control spotlight option.

Fresh WTR Pump

This breaker protects the fresh water pressure pump used for potable water.

Lazarette Lt.

This breaker protects the light under the aft cockpit floor compartment.

Nav Lts

This breaker protects the running light system including bow and masthead lights.

Trim Tabs

This breaker protects the trim tab motor located in the bilge compartment.

Windlass

This breaker protects the anchor windlass up and down rocker switch functions located in the bow anchor locker.

Bait Well Pump/Lt.

This breaker protects the cockpit bait well and inside light.

Wiper

This breaker protects the windshield wiper motor and harness.

Electronics

This breaker protects

Cockpit TV

This breaker protects the optional DC television located in the cockpit hard top aft ceiling locker.

Salt Water Wash down

This breaker protects the raw water wash down pump located in the bilge.

Cockpit Lts.

This breaker protects blue cockpit light system.

Windshield Vent

This breaker protects the windshield vent motor.

High Water Alarm

This breaker protects the high water alarm found in the bilge. Actual alarm is located on the port helm switch panel.

Hard Top Lts.

This breaker protects the DC hard top ceiling lights that provide general lighting for the cockpit.

Under Wtr Lts.

This breaker protects the transom mounted underwater lights.

12 V Recept

This breaker protects the helm mounted 12 volt accessory plug.

Gas Vapor Detect

This breaker protects the gas vapor system located in the bilge.

Acc

This breaker protects the air conditioner system pump motor.

Blower

This breaker protects the generator blower motor mounted in the aft starboard bilge.

Plotter

This breaker protects the optional helm mounted Garmin chart plotter.

Aft Cockpit Switch Panel (above refrigerator)



Bait Well

This switch controls the cockpit bait well motor and light.

Fish Box

This switch controls the macerator style pump that operates in the fish box compartment.

Raw Water

This switch controls the gunnel mounted raw water spray system.

Lazzar Lts.

This switch controls the aft storage compartment lights.

HTop Lts

This switch controls the hard top lights. Off is center. Up is side floods. Down is overhead bank.

Other Vessel Switches

Seat Switches

There is a switch for controlling the fore and aft movement of the driver's seat. It is located to the right of the driver's seat.

Engine Starting/Stopping Controls

Overview

The following general information covers basic starting and stopping of your outboard engine(s). Read and understand all information on remote controls, fueling and operational procedures. Pay particular attention to all labels. Refer to the outboard engine owner's manual for further in-depth propulsion system starting information.

Ignition Panel



Make sure the battery switch(es) are turned the "on" position. Start engine only in a well ventilated location to avoid CO buildup.

Locate the remote control handle in the neutral position. Advance the neutral throttle position as instructed in the engine owner's manual. Connect the safety lanyard to a belt or secure piece of clothing. Ensure the lanyard is secured to the ignition panel post or the engine will crank but not start. Keep passengers seated and away from controls.



Typical Start/Stop Panel

To start twin Yamaha outboards ensure the remote control is in the neutral idle position. Next, turn the key switch to the extreme right (ignition or “on” position) or the engine will not start. Press the start/stop button and you will hear the starter cranking over the engine. When started, release the button. Repeat procedure with the other button to start the other engine.

To stop twin Yamaha outboards make sure the control is in the neutral idle position before attempting to shut down the engine(s). Always let the engines idle for a few minutes after a hard run. Then press and hold the start/stop button for each engine or turn the ignition key to the “off” position which will stop both engines.

Remote Control

Dual outboard vessels use a twin binnacle control for shifting and throttle operations. The remote control handles control forward, neutral, and reverse outboard shifting operations for both engines. The control handles can be used independently for maneuvering in tight quarters. The control features power trim up and down functions. See the following information for component description and features. Read and understand the outboard motor manufacturer’s manual before attempting to operate the vessel remote control.

Practice docking operations using the remote control in a controlled environment to learn the basic control functions.

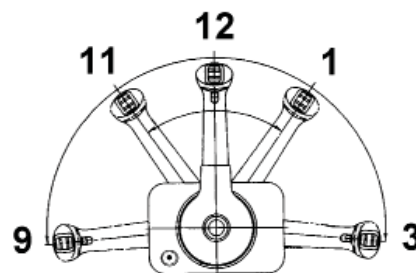

Profile Of Typical dual Engine Control Lever Showing Five Positions



Shown in the neutral position with idle throttle control. This is the detent position for starting and stopping the engine(s). Pushing the detent button in and pushing the throttle handle forward will afford increased neutral rpm throttle advancement.

CAUTION

AVOID ENGINE DAMAGE OR FAILURE!
CHECK THE ENGINE OIL LEVEL
BEFORE STARTING. IF LOW ADD
APPROPRIATE OIL TYPE AND QUANTITY.



Pushing the throttle control lever forward from the neutral 12 o'clock position to the 11 o'clock position will engage forward gear with minimal throttle. From the 11 o'clock position to the 9 o'clock position, the vessel is in forward gear with differing levels of throttle selections.



Pulling the throttle control lever back from the neutral 12 o'clock position to the 1 o'clock position will engage the reverse gear with minimal throttle. From the 1 o'clock position to the 3 o'clock position, the vessel is in reverse gear with differing levels of throttle selections.

As you shift from neutral to forward or reverse, push the neutral release button, this allows the control lever to come out of the indented position.

The control lever features a *neutral safety switch* which ensures the outboard engine and control are in the indented neutral position for starting the engine. You will hear a distinct sound and will feel the remote control's rotation lock once in the detent position. If you turn the key and press the start/stop button and the engine starter doesn't crank the engine, ensure the control lever is in the neutral position.

Your control lever also features a trim control switch. This switch allows the captain to set the trim for the outboard drives from the helm either up or down to achieve a desired outboard running position.

Follow these points when shifting:

- DO NOT shift quickly from forward to reverse gear positions. Drive system damage may occur.
- DO NOT "pump" the throttle in neutral as it is normally not needed since today's engines use an enrichment valve system that requires very little starting throttle.
- DO NOT try to shift into forward or reverse gear at high rpm's. Personal injury, drive system, or property damage may result.
- Only use idle throttle positions when docking or maneuvering in tight quarters.
- Wear your safety lanyard at all times.
- Never shift the controls with the engine not running. Control, linkage, and/or outboard drive gear damage may occur.
- For more information, read your outboard engine manufacturer's manual before operating the remote control.

Safety Lanyard (Interrupter Switch)

The safety lanyard (found on the ignition panel) sometimes called an interrupter switch is attached to the operator and the ignition panel. Should the operator lose control of the vessel and become dislodged from his/her seat or fall overboard, the lanyard will shut the engine off. Make sure the lanyard is installed to a part of clothing such as a belt or belt loop before operating the vessel.



WARNING

LANYARD MUST BE ATTACHED TO THE OPERATOR WHILE THE ENGINE IS RUNNING. A QUALIFIED OPERATOR MUST BE IN CONTROL AT ALL TIMES. READ AND UNDERSTAND THE OWNER'S MANUAL BEFORE OPERATING VESSEL.



WARNING

IF THE LANYARD IS IN THE "OFF" POSITION, THE ENGINE WILL CRANK OVER BUT WILL NOT START. ENSURE SAFETY LANYARD IS ATTACHED CORRECTLY AND SWITCHED TO THE RUN POSITION ON THE IGNITION PANEL.

Engine Power Steering

Your outboard boat features as standard equipment an electronic helm "power steering" system. We will briefly describe the system and display various parts and their function. Overall this system lends itself to single and dual outboard installations well with an effortless "power steering" feel. In addition, this system features light friction at low speed and higher friction at higher speed to provide a higher degree of maneuverability. Furthermore, it can be programmed for toe-in and toe-out settings which provide optimum vessel performance.

Also, this system eliminates the need for a tie bar which normally is used in twin outboard installations.

The hardware at both the helm and engine must be checked regularly for tightness, lubrication, and leaks. Check the steering system for full steering to port and starboard before disembarking.

The main system components are the electronic helm, electrical connection board, hydraulic steering pump and "smart cylinder". Note the adjacent drawing which shows normal system components. For service contact your closest authorized Regal dealer.

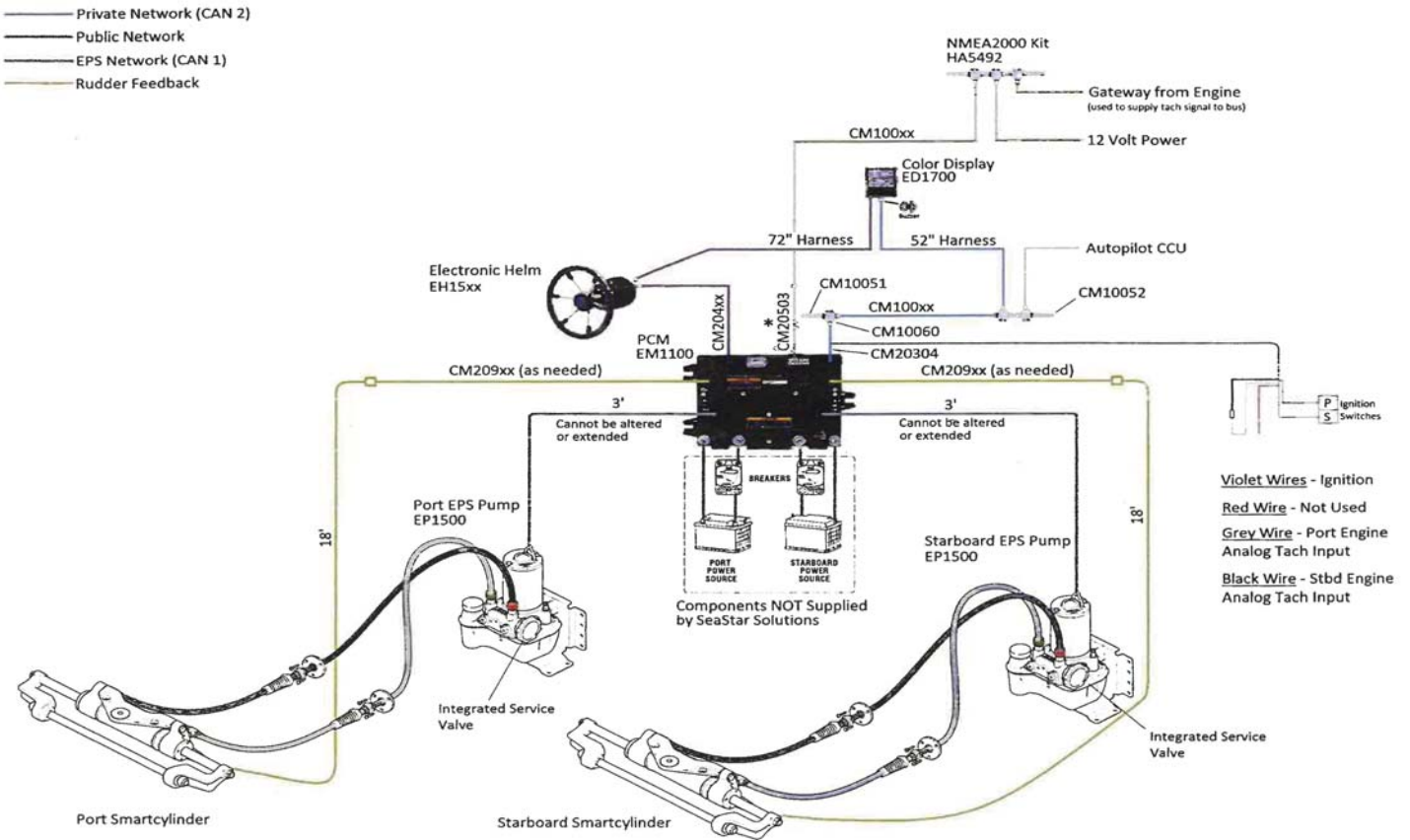

Electronic Helm

The electronic helm features a sport steering wheel and several tilt positions for maximum control taking into account individual driver needs and body types. The steering wheel motion can be adjusted to various lock to lock turning positions, along with the ability to adjust wheel friction tension through the cruising rpm range to afford the greatest driver control and feel at the helm.

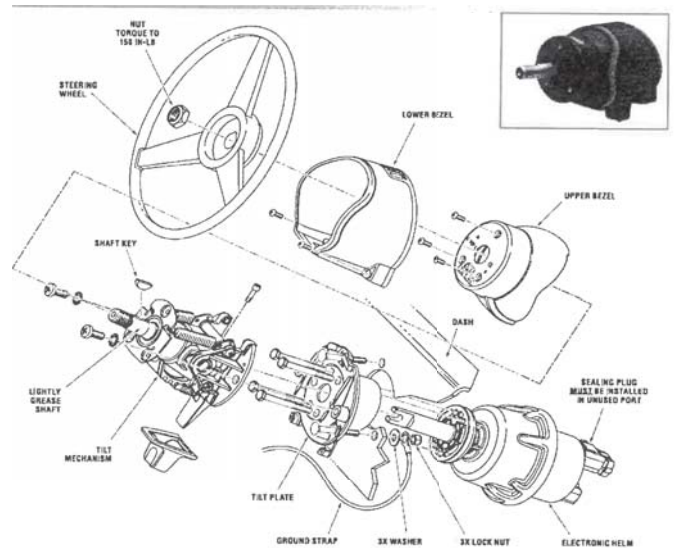

Power Steering Wiring

The electronic power steering is an on demand system using minimal power. The system uses two 60 amp breakers (one per starting battery) located near the battery source. The breakers are between each battery (twins) and the PCM mounting board. The illustration below shows a typical twin engine steering setup.

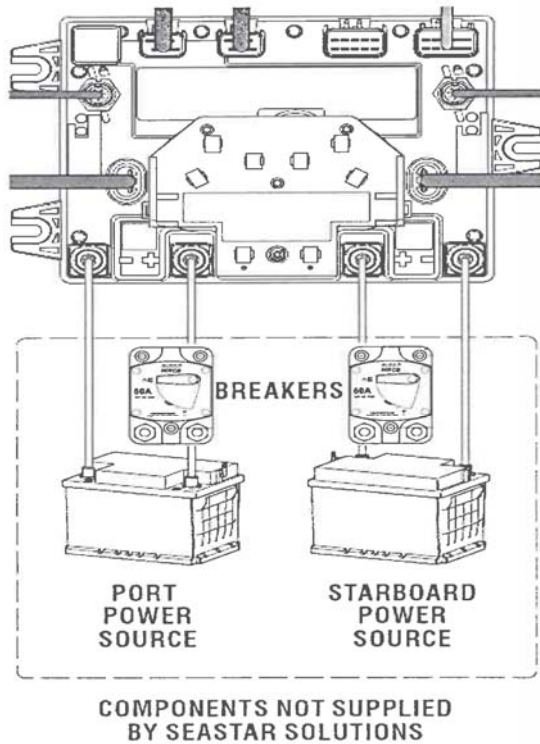

Hydraulic Steering Pump



Located under the aft center cockpit storage compartment is the steering system hydraulic pump system. Each pump controls the port or starboard steering cylinder. The Optimus steering system uses the HA5482 EPS power steering fluid.

Do not use any substitutions. It is a good idea to have extra fluid, funnel and cloth on board for emergency filling of the system. Also, note that there is a service valve located on each pump. It allows for manual realignment of the engines during service or a system fault. Use the decal information as needed for manual realignment situations. Engine(s) must not be running while performing these realignment procedures.

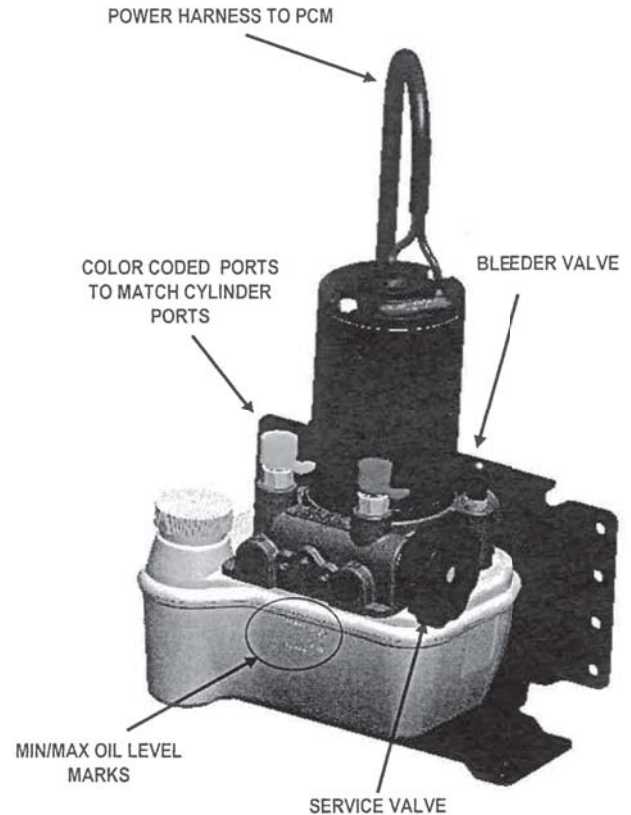

Smart Cylinder

Located on the front of each engine is the steering smart cylinder. It is foot printed with redundant sensors to determine the steering response to the wheel movement. If one sensor should fail there are back-up ones on each cylinder. The stainless steel cylinder includes ORB fittings with bleeders to purge air as needed.



Smart Cylinder Description

For information purposes components used in the smart cylinder are shown in the drawing. This illustration may be useful too for ordering needed parts as well as a troubleshooting breakout. Contact your closest Regal dealer to order parts.

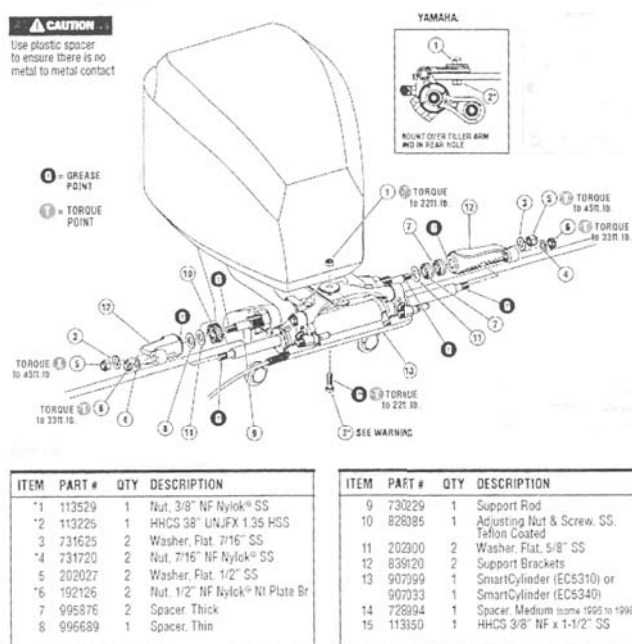

Chapter 6

Vessel Operation

Getting Underway

Pre-departure Questionnaire

- Have all fluid levels been topped off?
- Is the fuel tank full?
- Is all safety equipment accounted for and easily accessible?
- Are navigation lights and horn operating properly?
- Is the bilge free of water and does the bilge pump operate?
- Is the outboard engine and propeller in good working condition?
- Is the drain plug in place ?
- Have all passengers been briefed on emergency procedures and seated for departure? Is the boat load balanced?
- Is the operator sober, alert and ready to skipper the vessel?
- Have all passengers been fitted for life jackets?
- Has a float plan been filed and left with a component person?

- Has the bilge been sniffed and the fuel system leak checked?
- Are sea cocks open (if applicable)?
- Is all communication equipment in good operating condition?
- Has a second person been briefed on operational procedures should the skipper become disabled?
- Are all gauges and electrical switches functioning properly?
- Has weather information been gathered and analyzed?

Underway Questionnaire

- After casting off have all dock lines and fenders been stowed?
- Are all passengers seated and all doors closed and latched?
- As skipper are you monitoring the dash gauges and/or Garmin plotter for changes?
- As skipper are you on the lookout for changing weather?
- Is the remote control safety lanyard tightly secured to your belt or clothing?

Disembarking Questionnaire

Have you removed the keys from the ignition and secured them?

- Have all systems been checked for leaks?
- Has the battery switch been turned to the “off” position?
- Are all sea cocks closed (if applicable)?
- Has the fuel tank been filled enough to prevent condensation?
- Is the vessel properly tied and covered with equipment stored?

Fueling

**DANGER**

AVOID SERIOUS INJURY OR DEATH!
GASOLINE IS HIGHLY FLAMMABLE
AND EXPLOSIVE MATERIAL.
PRACTICE “NO SMOKING” AND EXTINGUISH
ALL FLAMMABLE MATERIALS
WITHIN 75 FEET
OF THE FUEL DOCK

**WARNING**

AVOID INJURY OR DEATH FROM FIRE
OR EXPLOSION
RESULTING FROM LEAKING FUEL!
INSPECT ENTIRE FUEL SYSTEM AT
LEAST ONCE PER YEAR.



WARNING

SINCE GASOLINE IS AVAILABLE
IN SEVERAL GRADES
INCLUDING ETHANOL AND VARIOUS OCTANE
LEVELS, REFER TO THE OUTBOARD ENGINE
MANUFACTURER'S OWNER'S MANUAL FOR THE
CORRECT GAS TYPE/GRADE.
USING THE IMPROPER OCTANE LEVEL
OR THE WRONG GASOLINE TYPE CAN CAUSE
ENGINE DAMAGE AND VOID THE WARRANTY!

Before Fueling

- Make sure a working fire extinguisher is available.
- Stop engines and any device that can cause a spark.
- Disembark all passengers and crew not needed for fueling.
- Fuel if possible during the daylight hours.
- Check to ensure nobody is smoking in the boat or near the fueling dock.
- Close all portholes, hatches and doors to keep vapors from blowing aboard and settling in the bilge.
- Tie up your boat securely at the fuel dock.
- Identify the fuel fill. Unfortunately, people have mistakenly filled the water or waste with fuel.
- Visually inspect all fuel system components before each filling.
- Avoid using fuels with E-15 alcohol additives. It can attack fuel system parts along with hoses and cause deterioration.

During Fueling

- Keep the fuel nozzle in contact with the fuel fill to guard against static sparks. The fuel fill pipe is grounded through the fuel system wiring to protect against static electricity.
- Avoid overfilling the fuel tank. Leave room for expansion. Also, if fuel exits the fuel vent indicating the tank is full, this situation is dangerous and unfriendly to the environment.
- Avoid spilling any fuel. Clean up any fuel accidentally spilled with a clean rag and dispose of it on shore.

After Fueling

- Close all fuel fill openings tightly. Use a fuel key if needed.
- Open all portholes, hatches and doors if applicable.
- Sniff in the bilge and engine area for gas fumes. If fumes are detected continue to let the area ventilate until the odor is gone. Look for any traces of fuel droplets or spillage. Do not start the engine(s), smoke or run any electrical components until the fumes can no longer be detected.

Dock Line Basics

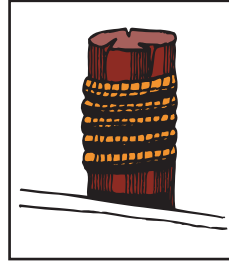

Most skippers use dock line terminology fairly loose but there is more to the basics than just bow or stern lines. There are several lines that can be secured to the bow and stern and depending on their direction and use, can be called other names. Remember that “forward” and “aft” refer to the direction that a spring line runs from the vessel, and not where it is secured on board.

Bow/Stern Lines

There is only one true bow line. It is secured to the forward cleat and run forward along the dock to prevent the vessel from moving to the stern. The stern line leads from a rear cleat to a piling or cleat on the dock astern of the vessel. This line keeps the boat from moving ahead. For small vessels these are the only lines needed for normal wind and current conditions. If located in a tidal environment, keep slack in the lines.

Breast Lines

These lines are attached to the bow and stern that lead to nearly right angles from the center of the vessel to the dock. They help keep larger vessels from moving away from the dock, or are pulled in to help people board the vessel. Larger vessels may use bow or quarter breast lines.

Spring Lines

Most small boats use two spring lines although it is possible to have four. They are called the after bow spring and forward quarter spring.

Bow springs are secured at the vessels bow area.

Forward spring lines lead forward from the boat to the dock and control movement toward the stern. After springs stem aft from the vessel, and stop movement ahead. Spring lines are used to prevent movement in a berth, ahead or astern. They are really useful in controlling the effects of a real active tidal surge. Spring lines are useful where fenders need to be kept in place against piles.

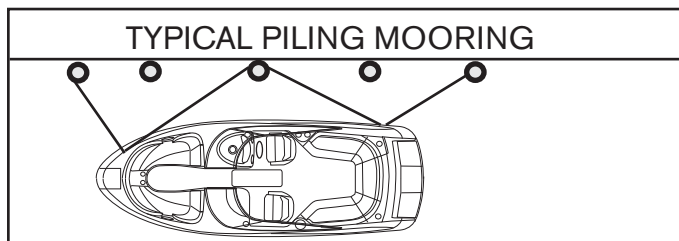
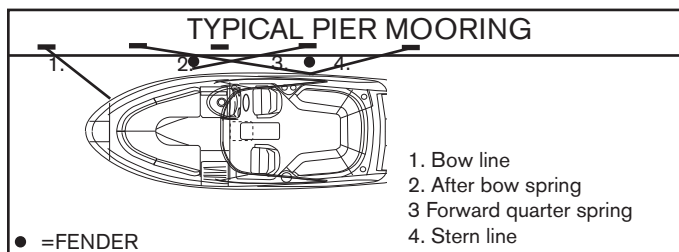

Boat Mooring

Most boats can be secured to a dock using four lines. The after bow spring is crossed with the forward quarter spring and secured to individual dock cleats or pilings. This ensures longer springs and can be snugged up tighter for more efficient tidal control.

Remember, if you only have one piling available, position the vessel so this point is opposite amidships. Run both spring lines to it. These lines will be shorter but still useful. The bow and stern lines should be relatively at a 45 degree angle with the dock. The stern line can be attached to the near-shore quarter cleat, but will work more efficiently to the offshore quarter cleat. The longer line will allow the boat flow with the tide with less time checking the vessel.

Dock Line Sizing

Most dock lines today are made of nylon, either of twisted rope or braided core and cover. The most often used material is nylon because of its stretching abilities absorbing shock loads. It is chafe resistant for extended life and is easier on bare hands.

The line's size varies with the vessel. Normally, a vessel in the 20' to 40' boats will use 1/2" diameter nylon lines. Larger yachts use 5/8" and 3/4" diameter nylon lines. Smaller boats can use 3/8" nylon lines.

Dock lines need to have the strength to hold the vessel and have enough density to resist chafing. They shouldn't be too heavy that they lose their shock-absorbing capabilities. Use the right size line for the vessel since a line too large for the boat will pull hard against the vessel since it won't be forced to stretch. If the line is too small for the vessel, there is no margin for wear and chafe when under strain.

Securing Dock Lines

When mooring your boat, make sure the dock lines are secured at both ends. Depending on your situation you may need to loop the eye splice of the dock line around a piling.

Sometimes the mooring line will lead down sharply from the piling to the deck cleat. Loop the eye splice around the piling twice to keep it from being pulled up off the pile.

Pull the line through the looped eye if the mooring line is too small to go around the piling twice or too small to fit over once.

If you must drop a line over a piling that already holds another boat's line, run the eye of the line up through the first eye from below, then loop it over the pile. This will allow either line to be removed without disturbing the other. If another line is dropped over yours, simply reverse the process. Secure a little slack in the other dock line, then slip your eye up through its loop and over the top of the pile. Your line can be dropped through the other eye.

When debarking from a dock, it is easier to release the line from a cleat or piling, from on board the boat, as soon as you leave the dock. Loop a long line around the cleat or pier and leading both ends on board you can release the line easily. Slip one end around the cleat or pile, then pull it back on board. Release the line without the eye splice, so it will run freely from around the pile without hanging up on the splice.

Fenders

Fenders are normally made of a rubberized plastic and are usually filled with air. Most have a fitting like a basketball so they can be inflated or deflated. Fenders are available in a wide range of sizes and shapes to fit both small and large vessels. Fenders are normally designated in inches. They are used between piers, docks, sea walls and the boat.

They protect the top sides of the boat from rubbing against rough objects. Most fenders have eyes of attachment which allow a line to be inserted vertically or horizontally. This will permit the fender to be tied off to fit a variety of marina, dock and tidal situations. Be sure the fender is correct for the vessel size. It is a good idea to carry extra fenders but half a dozen is normally an acceptable number. Remember to store fenders on board so they can be easily accessed. Some people incorrectly call fenders "bumpers".

Note that optional fender clips are available for your vessel.



There is a variety of fender styles and types, each selected for specified uses. When choosing fenders, contact a marine dealer or supply house. Explain how you moor and use your vessel so they can recommend the best fender type for you. We suggest the type with a fill plug so you can inflate them with a hand pump like the ones used for bicycles.

Outboard Maneuvering

Directing propeller energy (thrust) makes slower speed maneuvering easier. The propeller discharge current is turned from one side to the other which results in turning forces. Rudder boats need water to flow by the rudder to be efficient. Outboard units are designed to have reduced shaft angle, so the propeller does not produce as much unequal blade thrust and resistance. Large horsepower outboard boats do produce more thrust and steering torque but your vessel has the advantage of assisted power steering.

Below is some basic information on how outboard boats handle in normal conditions.

Gathering Headway

When an outboard drive is not moving forward or reverse in the water and the propeller is not turning, (shift in neutral) the boat will not react to the helm steering wheel.

As soon as the vessel is shifted into forward gear propeller action creates a discharge motion and generates energy in the form of thrust. If the outboard drive is centered, the discharge motion is directed straight back causing the vessel to advance forward.

You may notice that if you advance the throttle quickly in initial take-off (make sure you have a firm grip on the wheel), the boat has a tendency to pull the stern of the vessel to starboard. There is a trim tab (also serves as a sacrificial anode) located on the outboard drive housing. This trim tab helps compensate for the low speed steering torque. Once the boat increases headway and the propeller is operating in a faster water flow this torque effect decreases.

Sometimes the trim tab may need adjustment. Contact your Regal dealer for further information or consult your engine manufacturer's manual.

Turning

Once the boat has gathered headway, with the boat planing at the correct bow angle and the outboard drive unit and helm straight the boat tends to stay on a uniform course heading. To assure the boat trim angle is correct use the chart plotter screen trim gauge as a guide while activating the trim button on the remote control panel.

When the helm wheel is turned to the right or starboard, the drive unit is turned in the same direction. The propeller's discharge force is directed to starboard forcing the boat's stern to port. Water flowing past the hull strikes the stern drive gear housing in its starboard side, creating additional turning torque. The stern starts a move to port, forcing the bow to starboard.

If the helm is turned to the left or port the drive turns to port, the stern of the boat goes starboard as the bow turns to port.

As the vessel operator gains experience, he will better gauge each maneuver and speed situation. In this way he will understand the handling characteristics of his boat. He needs to keep the safety of his passengers in the highest priority.

Backing Down

If your boat has the steering wheel and outboard drive straight with the control in reverse, the stern will be pushed a bit to port by the reversing propeller thrust. This tendency to back to port can be eliminated by turning the outboard drive to starboard.

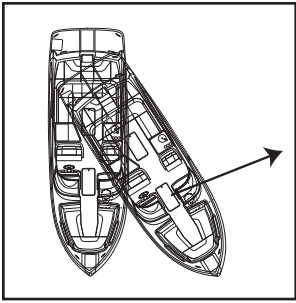

When the vessel begins to gather speed to stern, the water passing by the lower gear case housing will continue to increase steering torque. If the helm wheel is turned to

starboard, and will direct the propeller thrust to port, tracking the stern to starboard.

Wind and current will affect how a vessel backs. Outboard drive boats tend to be light displacements and when backing down in a strong crosswind, the bow will tend to fall toward the windward. This may cause steering problems.

Stopping

Remember that your boat does not have any brakes. It uses reverse thrust from the propellers to stop. If the vessel has headway, with the helm and propeller in reverse the propeller thrust is directed backwards, past the lower gear case. Depending on how far the throttle is advanced, the discharged thrust may not be strong enough to reverse the water flowing by the gear case. As the power is increased, the propeller thrust becomes strong enough to stop the flow of water past the lower unit, and, as the throttle is advanced it reverses its flow more completely.

When water is flowing past the gear case, steering torque is increased, but when the thrust stops the water flow, the boat will not respond to the helm. This is a short lived event and is overcome quickly when the water again flows past the gear case. Furthermore, added to the energy of the water hitting the lower gear case, the propeller thrust is directed by turning the outboard drive unit which can add to the steering torque.

The prop tends to throw the stern to port. This is why experienced skippers undertake a port side landing when wind and current conditions permit. They allow the prop to move the stern to port toward the dock. With a forward motion when the helm wheel is turned hard to one side, the vessel pivots around a point about 1/3 its length abaft to stern.

Power Trim/Trim Tabs

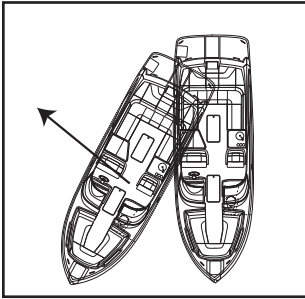

Twin outboard boats have the ability to angle in or out their drive unit in relationship to the transom. This is accomplished by hydraulic shocks located on the lower unit housing along with an electrical

sender unit that reads the drive angle and sends information to the chart plotter showing a reading.

Purpose of Power Trim

The purpose of the power trim/tilt is to enable the operator to change the angle of the outboard drive while at the helm. Changing the angle of the drive or “trimming” provides the following benefits:

1. Improves acceleration onto a plane.
2. Maintains boat on plane at reduced throttle settings.
3. Increases fuel economy.
4. Provides smoother ride in choppy water.
5. Increases top speed.

In short, it is a way of fine-tuning the performance of your boat and will enable you to get the most efficient and comfortable ride possible, whatever the conditions.

Using Power Trim

The power trim is normally used prior to accelerating onto a plane, after reaching the desired RPM or boat speed and when there is a change in water or boating conditions.

Position passengers and equipment in the boat so that the weight is balanced correctly fore and aft as well as side to side. Trimming will not compensate for an unbalanced load.

To operate the trim, push the switch until the desired bow position is reached. The trim may be operated at any boat speed or at rest. Avoid operating the trim system when running in reverse. Observe the trim/tilt gauge which indicates the boat's bow position achieved by the trim angle of the vertical drive unit. “Bow-Up” corresponds to the upper portion of the trim range on the gauge while “Bow Down” corresponds to the lower portion of the trim range on the gauge.

To determine the proper trim angle, experiment a little until you are familiar with the changes in your boat. The vessel will be properly trimmed when the trim angle provides the best boat performance for the particular operating conditions. A trim position that provides a balanced steering load is desirable. To familiarize yourself with the power trim, make test runs at slower speeds and at various trim positions to see the effect of trimming. Note the time it takes for the boat to plane. View the chart plotter screen, tachometer and speedometer readings as well as the ride action of the boat.

Operation In “Bow Up”

The “Bow Up” or out position is normally used for cruising, running with a choppy wave condition, or running at full speed. Excessive “bow up” trim will cause propeller ventilation resulting in propeller slippage. Use caution when operating in rough water or crossing another boat's wake.

Excessive “bow up” trim may result in the boat’s bow rising rapidly, creating a hazardous condition.

Operation In “Bow Down” Position

The “Bow Down” or in position is normally used for acceleration onto a plane, operating at slow planning speeds, and running against a choppy wave condition. It is also used when pulling water skiers, tubers, knee boarders, etc. In this position the boats’ bow will want to go deeper into the water. If the boat is operated at high speed and/or against high waves, the bow of the boat will plow into the water.

Operation In ‘Level’ Position”

In normal running conditions, distribute passengers and gear so boat is level. At or below cruising speeds, trim the vessel for optimum performance. The trim gauge will show somewhere in the center of the gauge. This position will also enhance running visibility and overall stability. Again, each outing provides different wave, load and running conditions. Be prepared to make trim changes as needed.

	CAUTION
THE BOAT TRIM SHOULD BE ADJUSTED TO PROVIDE BALANCED STEERING AS SOON AS POSSIBLE EACH TIME YOU GET UNDERWAY. SOME BOAT/ENGINE/ PROPELLER COMBINATIONS MAY CREATE BOAT INSTABILITY AND/OR HIGH STEERING TORQUE WHEN OPERATED AT OR NEAR THE LIMITS OF THE “BOW UP”OR “BOW DOWN” POSITIONS. BOAT STABILITY AND STEERING TORQUE CAN ALSO VARY DUE TO CHANGING WATER CONDITIONS. IF YOU EXPERIENCE BOAT INSTABILITY OR HIGH STEERING TORQUE SEE YOUR AUTHORIZED REGAL DEALER.	

Shallow Water Operation

Operating your vessel in shallow water presents various hazards. You are more apt to hit a submerged object such as a rock, sand bar, stump coral, or other unmarked objects.

Pay close attention to your charts for descriptions of any shallow areas along with marked submerged objects. Always post a lookout when operating in shallow water. Trim your outboard drive up as needed to provide adequate draft. Set the alarm on your depth sounder and travel at a speed that will keep the boat level in these shallow areas.

If your boat strikes a submerged object stop immediately and check for hull, outboard drive and propeller damage.

TRIMMED “TO FAR IN” POSITION



TRIMMED “TOO FAR OUT” POSITION

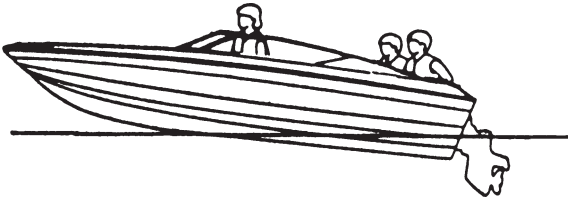

WELL TRIMMED “LEVEL” POSITION

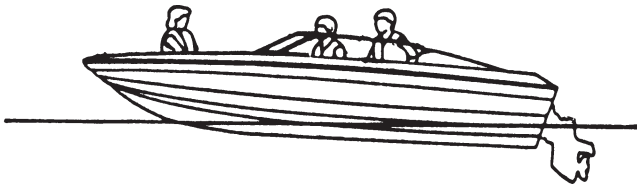

Typical Examples (Stern drive shown)

Anchoring

Selecting the correct anchor is an important decision. The anchor style in part depends on the usage and boat type. Regal boats designate an anchor type and or model. Some models incorporate chain, line with an optional windlass. Contact an authorized Regal dealer for more information.

Anchoring is easier with another person on board. First be certain that the line for the anchor is properly attached, to avoid losing the anchor and anchor line overboard.

For most anchors to perform more efficiently, you should attach 3 to 6 feet of chain. The chain will stand up to the abrasion of sand, rock, or mud on the bottom much better than a nylon line. It should be galvanized to reduce corrosion. Next, attach a length of nylon line to the other end of the chain.

The nylon will stretch under a heavy strain cushioning the impact of waves or wind on both the boat and the anchor.

To anchor, select a well protected area, preferably with a flat bottom. Contrary to modern belief, you do not throw the anchor over while the boat is making headway, or moving forward. In fact, the bow of the boat should be brought slowly backward, while easing the anchor slowly over the side of the boat until it hits the bottom. To “snub the line” means to stop its outward “pay” or movement. Usually the length of anchor line used should be 5 to 10 times the depth of the water.

After you have anchored, check your position with landmarks if possible. You need to continue to monitor landmarks to make sure you are not drifting.

Since anchoring can also be an emergency procedure, the anchor and line should be readily accessible.

For increased holding power in windy conditions, two anchors are sometimes set. If your primary anchor drags, you can run out your secondary anchor without picking up the primary one. The important thing is to lay them out at an angle. When setting two anchors, make sure they are fastened to separate rodes or cleats. This is done in case you need to adjust one later so the line is accessible. If two anchors are used ahead of a boat, make sure to set the rodes at an angle than in a straight line to reduce the chances of tangling as the boat moves in wind and current. See the illustration.

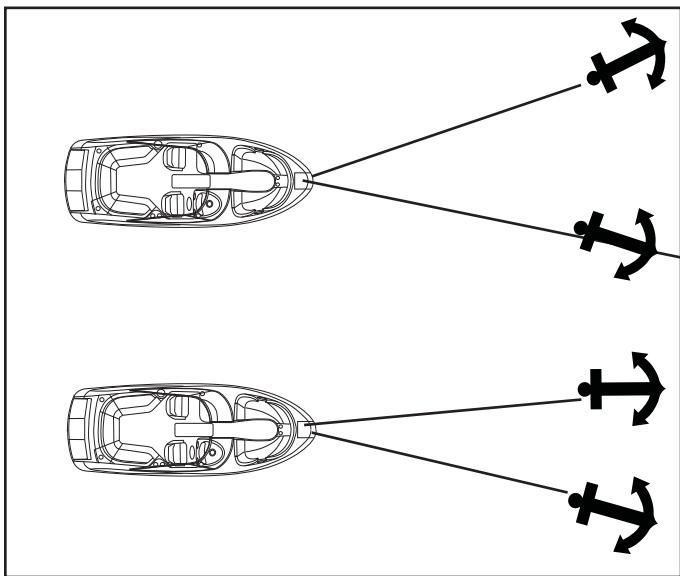

The Law Of Salvage

The Admiralty law sometimes referred to as the salvage law was founded primarily on English law fundamentals and basically says that a vessel distressed, in danger of flounder, if rendered assistance from a towing company or private agency, can be forced to relinquish a portion of the vessels' worth for the assistance received.

NOTICE

IN THE EVENT
YOUR VESSEL IS IN DISTRESS,
PRIOR TO ALLOWING ANY TOWING
COMPANY OR PRIVATE AGENCY THE
RIGHT TO PASS A LINE TO YOUR VESSEL,
BE SURE TO ESTABLISH THAT YOU
DO NOT AGREE TO SALVAGE RIGHTS.
ESTABLISH WITH THE CAPTAIN
OR OPERATOR THAT YOU WISH TO BE
ASSISTED IN A CONTRACT BASIS AND
ESTABLISH A PRICE.
OF COURSE IN CERTAIN SITUATIONS, YOU
MAY NOT HAVE THIS OPTION.

USE YOUR BEST JUDGEMENT!

Towing

In case you find yourself aground or in need of a tow, or should you want to tow another vessel, keep in mind that you never use deck hardware or cleats to secure lines for towing!

Deck hardware is intended for mooring and anchoring, and is not designed to withstand the strain and pull of towing. Rather than tie the line to your cleats on deck, it is suggested that you tie a bridle by passing a line completely around the hull of your boat to avoid damage.

When towing, always stand clear of a taut line, as any type of line breaking under stress can be extremely dangerous. The preferred line for towing is double-braided nylon, as it has sufficient elasticity to cushion shock loads. Move slowly and cautiously.



WARNING

AVOID INJURY OR DEATH!
DO NOT USE DECK HARDWARE
INCLUDING CLEATS
FOR TOWING.

Knots

Knots are useful in docking, towing and other emergency situations. Learning to tie knots requires practice. As they say “ Practice makes perfect”. Some of the knots used in boating are the square, bowline, anchor bend, clove hitch, figure eight and half hitch. There are several periodicals available that explain various knots and how to tie them effectively. An experienced skipper will know the basic nautical knots and will use them when on the water. Take the time to know the basic knots.

**Figure 8 Knot
Tied To Cleat**



A useful knot to learn for general docking is the figure eight with one end reversed. By turning the free end of the line back under, the knot can be released without disturbing the boat. After some practice one person can secure a vessel easily to a dock or pier in a variety of weather conditions. This knot normally is used to tie the bow and stern. Then the vessel can further be fastened by tying the spring line in the figure eight knot. Wrap it around the cleat 2 or 3 times.

Emergencies

Always be ready to help others on the water if possible, but do not take any unnecessary risks. Use equipment to save a life, but do not risk a life to save equipment. Consult earlier information in this manual concerning accidents, etc. Also, read other literature concerning on the water emergencies. Be alert and prepared!

Fires

Fire aboard a vessel can spread quickly and can cause tremendous alarm among everyone. Most fires can be prevented by keeping the bilge free from oil and debris. Keep all equipment stowed and maintained in working order. Carry a backup fire extinguisher on board. If something becomes a possible fire hazard, remove that possibility at once. Never use water on gasoline, oil or electrical fires. When you dump water on an electrical fire you can be shocked since water conducts electricity.

Follow these instructions if a fire breaks out:

- A. Fit everyone aboard with a life jacket. Turn off the ignition.
- B. Try to keep the fire downwind. If the fire is to the stern, head the bow toward the wind. If forward, put the stern to the wind.
- C. If the engine should catch fire, shut off the fuel supply. Usually there is a fuel tank access that you can crimp the fuel feed line.

D. Use a hand fire extinguisher. Make sure to point it at the base of the flames. Use short bursts and sweep the extinguisher side to side.

Remember : (4 lb. extinguisher discharges in 20 seconds)

These actions help prevent the fire from spreading to other parts of the boat. You can extinguish fires quickly if you act swiftly. Have a plan of action in motion in case a fire breaks out.

First Aid

Knowing first aid can save lives. A first aid kit and the ability to use it are important ingredients for the safety of a skippers' passengers, crew and vessel. Having confidence and competence in handling medical emergencies on board is a must for the skipper. Invest your time in a first aid course available at the American Red Cross.

CPR (Basic Life Support)

If someone is seriously injured have someone call for help while the injured person is being attended.

Check for possible danger signs; loss of breathing, unconsciousness, severe bleeding and heartbeat. If you determine the individual is not breathing or unconscious place the victim on their back on a hard surface and do the following:

1. If unconscious, open the airway. Neck lift, head lift or chin head lift.

2. If not breathing, begin artificial breathing. Pinch the nose. Give 4 quick breaths. If airway is blocked, try back blows, abdominal or chest thrusts and finger probe until airway is open.

3. Check for pulse. Begin artificial circulation. Depress sternum 2".

15 compressions rate 80 per minute. 2 quick breaths. Continue uninterrupted until advanced medical support is available.

Follow up immediately with medical authorities!

Hypothermia

Hypothermia is a condition where the body temperature decreases because the body can't generate enough heat to maintain its normal temperature. It can be serious and usually occurs where victims have been immersed in water (under 68 degrees) for extended periods of time. If you encounter a possible hypothermia victim call for help on the radio and get the person out of the water.

Symptoms are:

1. Shivering that if condition is advanced may stop.
2. Confusion, clumsiness or slurred speech.
3. Rigid muscles.
4. Semiconscious to unconscious.

Treat hypothermia by the following:

- Remove wet clothing.

- Monitor the victim's pulse and breathing.
- Rapidly apply heat to the body core by using blankets, naked bodies or warm water.
- Do not give the person any food or drink.
- Do not warm the arms and legs. Warming of these extremities can be fatal.

Follow up immediately with medical authorities!

Environmental Awareness

There are numerous vessels operating on our waterways on a daily basis. Each boat has an impact on our environment. Boat operation habits, marine sanitation, and maintenance all play a role in a delicate battle to keep the ecosystem clean. Each of us has a role in doing our part as an environmentally conscious skipper to conserve our waterways.

The National Marine Manufacturer's Association lists their top ten of Eco-Boating Practices as follows:

1. Observe all regulatory agency policies regarding marine toilets.
2. If equipped with a holding tank, use marina pump-out facilities.
3. If used, make sure bottom paints are legal and ecosystem friendly.
4. Use only biodegradable cleaning agents.
5. Dispose of all garbage and litter on shore properly, not on the water.
6. Don't top off fuel tanks. Leave expansion room. Clean up spills.

7. Watch your wake and propeller wash.

8. Make sure your engines are well tuned and maintained.

9. Control your bilge water.

10. When fishing, practice the "catch and release" principle.

Follow these basic practices when on the waterways. Treat the environment in a way that you would like to be treated.

Chapter 7

Auxiliary Equipment Operation

Overview

This chapter will assist the boat operator in understanding selected standard and optional equipment components on the vessel. *Select equipment described may not be installed on your boat or the pictorials may not exactly resemble equipment on your craft.* Remember, Regal is constantly improving its product line and therefore may make changes in vendor parts and specifications without notice. For detailed information on equipment, please refer to the owner's information packet.

Anchor Windlass

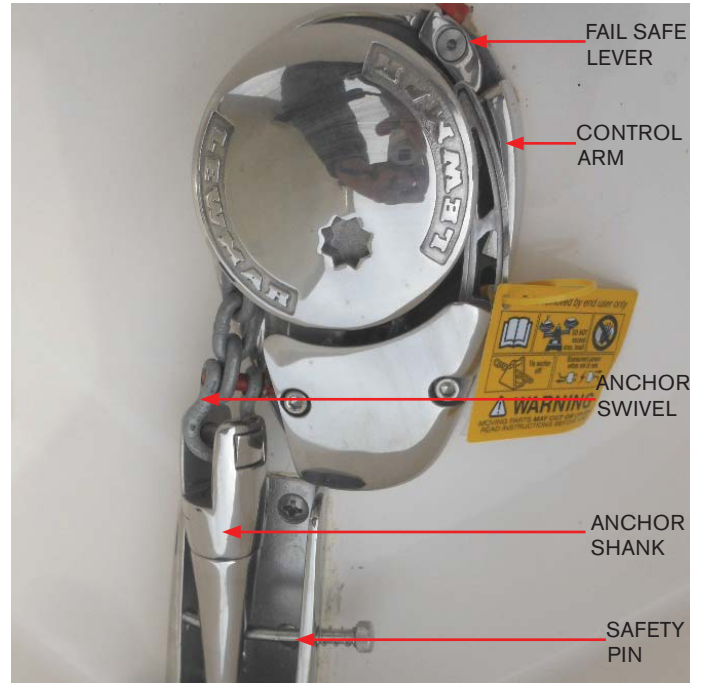
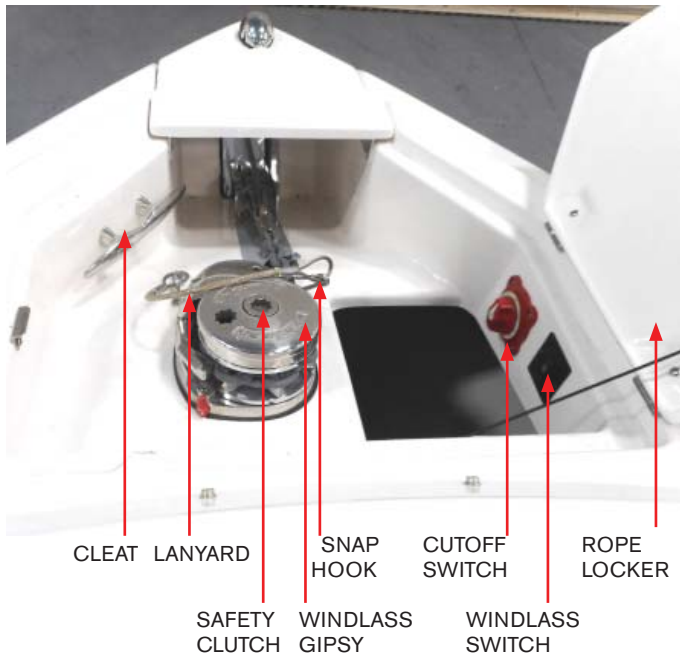

Anchor Windlass Introduction

If installed the windlass features a stainless steel polished “claw” style anchor complete with swivel. This anchor has high holding power in most sea-beds.

A momentary windlass rocker switch located at the anchor locker controls the lowering and retrieving of the anchor through the windlass. A 50 amp breaker for windlass over current protection is located at the battery management panel. There is a lanyard with a snap hook to add holding power when the anchor is in the stored position. The cleat is for tying off the anchor rode rather than maintaining constant pressure on the windlass itself.

Note: Never use the windlass to break the anchor free from the bottom. This may cause excessive strain on the windlass motor and or hardware.

Using Anchor Windlass

The windlass may be outfitted with a rode using 100' of 1/2" nylon rope along with 10' of galvanized chain. The chain is connected to the anchor shank which is next to the anchor. The chain acts as a safety margin to protect the rope rode from being damaged by sharp seabed objects such as coral that might sever the rope if it was next to the anchor. If needed for harsh sea bottoms the rode can be converted over to 100' of 6 mm galvanized chain with a small length of rope at the top for tying off the rode to a cleat.

The safety clutch is used to "pay out the windlass chain or to retrieve the anchor "rode". There is a handle in the anchor locker that inserts into the gypsy drive cap located on top of the windlass framework.

With the handle inserted in the cap, turn the handle *clockwise* which grips the "gypsy", locks it and **tightens the clutch**. Remove the handle and store it after usage.

To **loosen the clutch** with the handle inserted in the cap, turn the handle *counterclockwise* which will free up the "gypsy" from the drive train. Remove the handle and store it.

Before attempting to "pay out" the anchor **ensure that the fail safe pawl is disengaged from the gypsy and held clear of it by the fail safe lever**. See windlass owner's manual for further information.

Be sure to pull the safety pin from the anchor shank before using the system. *The anchor will not pay out with this pin inserted.* This pin should be reinstalled after each anchor retrieval.



WARNING

AVOID SERIOUS INJURY!
ENSURE THAT ALL BODY PARTS & CLOTHING
ARE KEPT CLEAR OF THE ANCHOR RODE
AND WINDLASS DURING OPERATION.



WARNING

AVOID SERIOUS INJURY!
DO NOT "PAY OUT" ANCHOR UNTIL IT IS
DETERMINED THAT THERE ARE NO
SWIMMERS OR DIVERS NEAR THE AREA.

Paying Out Anchor Using Gravity

To let out the anchor release any anchor locks, insert the clutch handle into the gypsy drive cap and turn it in a clockwise direction to tighten the clutch. When in a safe mode, pull back on the clutch until the anchor and rode begin to pay out. Control the rate of anchor descent by pushing the clutch lever forward. When the desired rode is paid out, tighten the gypsy drive cap.

Paying Out Anchor Using Power

Make sure any anchor locks are disengaged and the pin through the anchor shank is pulled along with the lanyard hook. Stand clear of all windlass components when paying out. Using the windlass momentary switch, press and hold the lower portion of the switch.

When the proper ratio of anchor rode is paid out disengage the switch and tie off the rode to a cleat since it is not recommended to let the windlass mechanism be the only source holding the rode to the anchor on the sea bottom. Also, do not use the fail safe pawl to hold the anchor load as windlass damage could occur.

Hauling In Anchor-Manual Recovery

Insert clutch handle into the gipsy drive cap and turn clockwise until anchor is fully returned to the bow roller.

Hauling In Anchor-Using Power

When anchor rode is safe to haul in use the windlass momentary switch to haul in the anchor rode. Press and hold the upper portion of the switch until the anchor is returned to the bow roller position.

The fail safe pawl does not need to be disengaged during retrieval as it will act as a ratchet. When the anchor has been retrieved in the bow roller position the fail safe pawl should be left engaged in the gipsy to prevent accidental activation of the windlass while underway. Also, reinstall the pin through the anchor shank and the lanyard hook. Note that the fail safe pawl does not need to be disengaged from the gipsy before the anchor can be paid out again.

It is recommended that during the paying out process the engines be run to stern before full scope is reached. This will help prevent the rode from being tangled in the anchor on the sea bottom. It is recommended that during the retrieval process use the engine to gather headway.

Do not let the vessel sit directly on top or over the area where the anchor lies because the chain rode could damage the hull topside.

As the anchor raises toward the scuff plate area, retrieve the last few feet very carefully to eliminate any hull damage.

Once the anchor is retrieved, check to ensure the fail safe pawl is engaged in the gipsy which will help prevent accidental activation.

Windlass Safety Tips

1. Read the windlass owner's manual.
2. Keep all body parts and clothing away from an activated windlass.
3. Do not exceed the maximum load designated by specifications.
4. Always tie off the anchor rode to the designated cleat.
5. Do not use the windlass to pull or tow another vessel.
6. Always shut off windlass breaker or main battery switch before servicing the component.
7. Always use engine power to gain headway before retrieving anchor.
8. Always look for swimmers or divers before deploying anchor.
9. Always secure rode/anchor while cruising or pulling vessel on highway.

Bilge pump

Before each outing, check the operation of the bilge pump, automatic switch, and manual switch. The bilge pump should automatically activate when water reaches a pre-determined height in the engine compartment. Test the bilge pump manually at the dashboard with the switch. Periodically check for bilge debris around the grates of both the bilge pump and automatic switch, and also bilge pump impeller.

The automatic mode for your bilge pump works similarly to the manual method. Both methods control the bilge pump by a switch, but the automatic mode utilizes a float switch. Float switches have a float that sits at water level, and when the float reaches a certain height, it trips the switch and activates the bilge pump.

Periodically you may need to disassemble the bilge pump from the grate in order to clean or access the inner mechanisms. To remove the bilge pump, utilize the quick disconnect tabs on either side of the bilge pump, squeezing them like a backpack clip while pulling up on the pump.

For switch control location, refer to the engine and controls chapter. For bilge and drainage system information and electrical system information, refer to the systems chapter. Refer to the vessel operations chapter for pre-departure use.

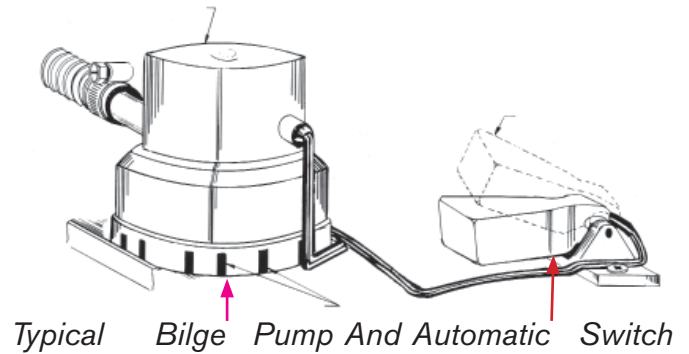

Bow Table

If installed the teak bow table is found in the large Lazarette cockpit locker. The table is secured to the underside of the locker. The table features teak a hardwood known for beauty and durability.

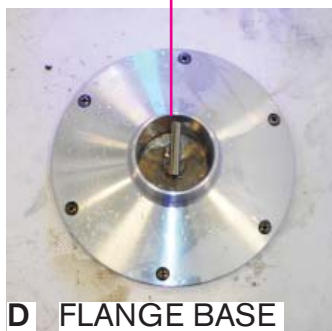

Setting Up Bow Table

1. Remove the table from the locker lid.
2. Find the flange base which is located in the starboard bow locker under the locker lid.
3. Unscrew the flange base center hold down mechanism and the entire unit will free itself.
4. Center the flange base over the floor base and line up the center holes. Screw the hold down mechanism clockwise until tight.
5. With the table turned over loosen the knob on the table support.
6. Insert the leg into the table support. Tighten the knob until secured.
7. Lift the table and leg assembly up and insert into the flange base. Wiggle the sides of the table as needed to until the leg is completely down.
8. To disassemble the table reverse the process.

Note that it is recommended that the table assembly be stored before making a major cruise into rougher seas or other adverse weather conditions.



Bow Thruster

General Safety Notices:



1. Be sure to read and understand the safety information and all thruster operation information before attempting to use the thruster system. Refer to the thruster manufacturer's

owner's manual for more detailed information.

2. Do not operate the bow thruster system close to swimmers as a high powered suction is produced at the propellers.

3. Make sure the propeller lock nut is torqued to the required foot pound specification.

Thruster Usage

To use the thruster first make sure the battery switch is activated. If necessary there is a on/off battery switch in the bilge that is in-line with the thruster power cable feed. Make sure the switch is energized.

NOTE that there is a joystick on the helm. The thruster will assist in slow speed maneuvering especially around a dock or close mooring situations. It operates similar to a gaming or marine propulsion type joystick. To activate the joystick, push and hold the black button. The red icon will illuminate.

Never run the thruster dry; it will weld the relay contacts as it becomes a generator in spool down.

Do not make quick changes from one direction to the other direction, or it will damage the unit. The minimum running voltage for the thruster is 10.5 volts; therefore the outboard engine(s) should be running to maintain this voltage requirement.

There is an in-line ANL type fast activation fuse for over current protection behind the thruster switch panel.

Cabin Entrance Door



The companionway door is a slider type engineered with heavy mechanical joints for added strength. The aluminum frame is typically finished in a weather resistant polyester powder coating. The tinted door surface is a high impact acrylic.

Note that when underway always ensure the companionway door is closed and locked. When moored ensure that if the door is left open and the latch is flipped across the track to prevent the door from closing.

Read and understand the care instructions in the care and maintenance chapter.

Canvas

Typically, there is a variety of canvas available for your vessel including bow cover with cockpit seat cover, manual bow and sunshade covers and helm enclosure.

Of course any of the above selections will improve the overall comfort and longevity of the parts that they cover. See the care chapter for cleaning information on vinyl or Sunbrella canvas types.



Cockpit Grill



Be sure to read the grill manual to become acquainted with all the safety features and proper modes of operation before attempting to use the grill. To use the cockpit electric grill you must activate the dedicated breaker on the ship's main panel.



Of course you must either be on dock side power or have the generator running as the grill operates at 120 volts.

Next, locate the grill controller on the face of the cabinet. Push the center button to activate the grill.

Change the grilling temperature by using the plus or the minus buttons on the grill control. There is a safety shutdown switch located at the aft grill corner. Read the grill owner's manual for further information. Always have a fire extinguisher handy. Should there be an emergency situation close the cover. Power to the grill will be shut down at this point. After grilling be sure to let the element cool before closing the cover.

Cockpit Grill- Safety Instructions

1. The unit is designed to cook food like meat, fish or vegetables. Do not use it for any other purpose since it could be dangerous.
2. Do not operate the grill in rough seas or high winds.
3. Do not add burning type charcoal briquettes or volcanic stones to the unit.
4. Never operate the grill while making headway (under engine power).
5. Never grill with the canvas in the up position since smoke and odors from cooking could infiltrate the canvas fabric over time.
6. Keep combustible material away from the grill.
7. Keep children away from a hot grill surface.
8. Keep the grill covered when not being used.
9. Let the unit cool down before attempting to cover it.

NOTICE

THE GRILL RESET BREAKER IS LOCATED AT THE REAR OF THE UPPER DRAWER. REMOVE DRAWER AND YOU WILL FEEL THE HOLE AT THE REAR OF THE CABINET. PRESS TO RESET.

Cockpit Refrigerator

If installed, the cockpit refrigerator provides chilled and frozen storage areas for food and beverage with a volume of 49 liters or close to 1.75 cubic feet capacity. It features a brushed 316 grade stainless



steel door and LED lighting along with an easy reach thermostat. The bin and bottle racks keep supplies secure in rough weather. Includes a freezer drawer. The unit operates at 12 volts DC voltage and draws approximately 6 amps along with requiring a minimum of 10.9 volts.

Using Thermostat Control

Note the thermostat (temperature control) in the above illustration. This device sets the refrigerator temperature and includes a power shut-off function when turned counterclockwise to the end position. To adjust the temperature, turn the thermostat clockwise in order to reach the recommended 5-6 degrees Centigrade or 41 degrees Fahrenheit. The cockpit refrigerator uses a 15 amp fuse for over current protection located at the safety hub inside the bilge.

Usage Recommendations

- If possible, the refrigerator should be turned on for about 6 hours prior to filling food items.
- Frequent opening of the refrigerator door will result in greater consumption.
- Ensure that nothing blocks the refrigerator vent.
- Keep the inside of the refrigerator clean and dry.
- Keep the surface of the door clean and dry.
- The unit has been designed with a product lock protection in the event of low battery voltage. In the event of a compressor block, follow the instruction in the manufacturer's owner's manual or contact a marine technician.
- Note that the compressor can operate up to angles of 30 degrees; greater angles can cause damage to the compressor.
- Note that the unit contains refrigerant type 134 A. In the event of a loss of refrigerant contact a qualified certified technician.
- Periodically clean the condenser unit behind the refrigerator. Dust or vacuum the fan from any dust or lint debris.
- See the manufacturer's owner's manual for defrosting instructions.
- Consult the manufacturer's owner's manual for any troubleshooting information or contact your closest Regal dealer.

Cockpit Sea-grass Mating



If installed, cockpit sea grass mats feature urethane backing for marine environments. The mats provide style, comfort and durability as well as additional

protection in environments where microbes are a concern.

Chilewich® products contain Microban®. This antimicrobial protection inhibits the growth of stain and odor-causing bacteria, mold and mildew for the product's life.

When storing your sea grass mats, always roll with the face of product out with the backing facing in. Do not fold or crease as the backing may split. Vacuum or hose off for regular cleaning. Dry face up or hang. Do not machine wash. Matting may be cleaned with a mild detergent and a sponge. Rinse with fresh water. Do not pull on material when removing from cockpit, but rather lift the snap instead to disengage.

Electronics

Various electronics components are available on the vessel including a cockpit hard top installed television, satellite KVH system, VHF radio, HD closed radar system, and autopilot.

Each component utilizes individual operator's manuals. Refer to the appropriate electronic component operator's manual for detailed product information since the vast amount of information can not be covered here.

These manuals will cover features, operation, alarm and safety systems along with maintenance schedules.



Fender Clips

The fender clip option features receivers integrated into the vessel hull side and quick release pins. The quick release pins attach to fenders with lines so they are ready to deploy as needed. When the vessel approaches a mooring the quick release pin with fender is attached to the receiver and pushed into place. This will help protect the boat from dock "rash" which could damage the rub rail or gel coat. When leaving the dock the pins feature a quick release mechanism which detach easily.



FENDER CLIP RECEIVER



FENDER CLIP RELEASE PIN

Flexiteek Decking

Flexiteek decking is available on selected models. It features significant advantages over similar wood products. It is made from synthetics. Color is as natural as timber and uniform through the entire thickness adding to its appeal. It sands like wood resulting in a natural wood look and feel. It provides superior grip making it great for boating in general and water sports. It is stain resistant with most stains washing away with soap and water.

The product is UV resistant. Gentle sanding removes most marks on the decking with a minimum of product loss.

Flexiteek may be installed on cockpit sole and/or on the swim platform.



Joystick

As part of the Yamaha Optimus steering system you may have a joystick installed on your vessel. The joystick permits the vessel to maneuver in tight mooring situations even made more opportunistic with wind and water conditions such as current. The joystick permits the boat to move 360 degrees and features a boost feature.



For more information regarding the engine joystick refer to the engine operator's manual located in the owner's information packet.

Remote Stereo Control



As part of the stereo components the remote control may be mounted top side where it makes controlling the main cabin unit much easier.

It is a plug and play device and uses the same function buttons and rotary encoder as the helm head unit. It features the ability to select various speaker zones on the vessel. Refer to the Fusion owner's manual for more detailed information.

SeaDek

As an option SeaDek® is featured on select vessel swim platform and walk through areas. The non-skid, closed cell material is derived from UV protected non-absorbent foam. You will find the product easy to clean with a high stain resistance.

Other features include noise reduction, great traction even when wet, body comfort when standing, walking or leaning on the swim platform .

To clean small dirt particles first try soap, hot water and a stiff brush.

For surface dirt and footprints use glass cleaner and a clean rag.

If a more thorough cleaning is needed you may use bleach, 409, Simple Green or Soft Scrub. Be sure to rinse thoroughly. Stay away from using any acid base cleaners.

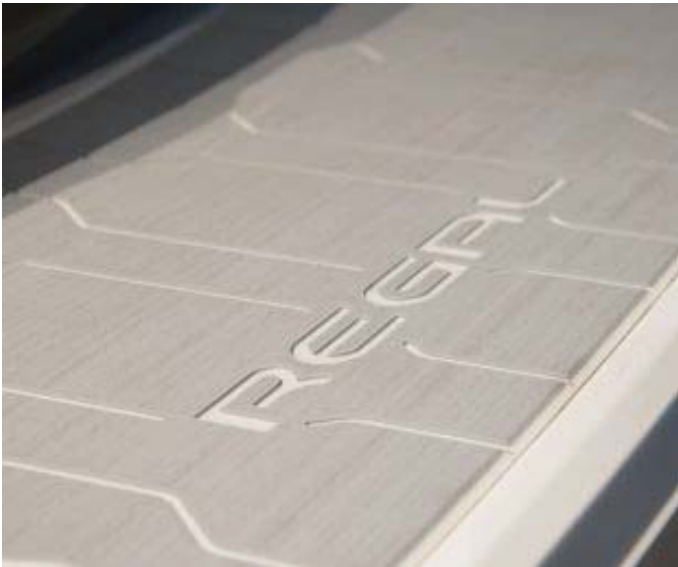

Seakeeper

If installed, the Seakeeper uses gyroscopic principles to reduce boat motions in waves and wakes independent of boat speeds. A typical unit consists of a Gyro assembly, a CAN communications cable, and a helm display.

If installed, the Seakeeper is located under the aft cockpit of your vessel. The unit's cycling is controlled by an electronic controller and a hydraulic brake throughout each roll cycle as to supply maximum anti-roll torque and limits mechanical contact with the hard stops that limit the gimbal angle travel.

The Seakeeper operates from DC (direct current) and the unit is part of the 2 house battery circuitry. There is a dedicated 100 amp breaker on the fire wall.

Seakeeper Display

The helm display is used to start, operate, monitor and shutdown the Seakeeper. Sensors, alarms, and shutdowns are provided to allow unattended operation. The display provides information in the event of an alarm. Select alarms can cause precession to stop and start the unit to coast down.



WARNING

AVOID SERIOUS INJURY!
ENSURE THAT ALL BODY PARTS & CLOTHING
ARE KEPT CLEAR OF THE SEAKEEPER
WHILE IT IS CYCLING.



WARNING

AVOID SERIOUS INJURY!
DO NOT REMOVE THE COVERS FROM
THE UNIT OR CONTACT ANY PARTS
WHILE THE UNIT IS PRECESSING.
MAINTENANCE SHOULD NOT BE DONE
UNLESS THE SEAKEEPER IS LOCKED AND
FLYWHEEL HAS STOPPED SPINNING.

After 12 volt power is present. the Seakeeper screen will energize and a home screen will appear. Here the ON/OFF touch screen button will appear grey (OFF). Once the button is pressed it will change to blue (ON) and menu button is used.

When the menu button is pressed, a menu bar will appear or disappear at the screen bottom. The menu bar is used to navigate between pages. Refer to the Seakeeper operation manual for further information regarding the display, operation and understanding the alarm screens.

Also, specifications, troubleshooting, winterization, warranty, and periodic maintenance requirements are found in the operation manual.

Side Boarding Door

The side boarding door features a 316 gauge heavy duty hinge and latching system. It provides easy access for various mooring situations.



To open the boarding door from the inside press the center lock button inward while pushing the latch handle down which will release the latch from the receiver plate. See the above photo.

To close the boarding door push inward and hold the center lock button and lift the handle up until it enters the receiver plate. Release the lock button. Check to ensure the door is locked.

The door swings inward and features a magnetic stop. The skipper needs to make sure the boarding door is latched and locked at all times.

 **WARNING**

AVOID INJURY OR DEATH FROM FALLING
OVERBOARD!
ENSURE THAT THE TRANSOM DOOR IS
LOCKED AT ALL TIMES.

Stereo (Typical)



Regal boats feature Fusion® marine stereo audio systems. Fusion stereo systems are designed and engineered to perform to the highest standards in the harsh marine environment. The head units feature easy to read displays and use oversized rubber buttons and controls for easier operation on a moving vessel. All components including the speakers comply with the international IP waterproof standards. Selected optional system components include an amplifier and additional speakers.

The unit features a UNI-DOCK for safe charging and playback of the latest Apple IOS and MTP Android/Windows media devices. Also, the unit feature Bluetooth A2DP audio streaming capabilities, Pandora radio and NMEA 2000 conductivity. The system utilizes a 15 amp automotive style fuse located behind the stereo head unit.

Currently a stereo performance package featuring Signature Series amplifiers, speakers and remote control along with LED cluster type speaker lighting is a standard configuration on your vessel.

Cockpit Television

1. If installed the cockpit television drops down from the aft hard top ceiling locker. The television requires 120 volts AC. To operate do the following:
2. Install the coaxial cable between the shore and the vessel along with the dockside cord.
3. With ship's AC panel on, activate the aft outlets breaker at the ship's main AC panel located at the cabin stairway.
4. Use the remote and power up the television.

Note that the start-up television procedure just reviewed is for systems without KVH satellite TV.

KVH satellite television at sea start-up do the following:

1. Activate the SAT TV breaker at the ship's main AC panel located at the cabin stairway.
2. Push the ship's antenna button (B). This will power up the special antenna to receive satellite signals.
3. Power up the satellite receiver. Refer to the KVH owner's manual for more information.

One feature of the cockpit television is that with the plotter energized to a particular screen the skipper can display that screen at the television. Just choose HDMI 2 on the cockpit television remote. HDMI 1 on the remote controls the BluRay player functions.

All television coaxial splitters and the booster for the television mushroom antenna are behind the main ship's AC panel. **With the shore power disconnected at the vessel inlet** access can be found by removing the 6 phillips panel screws.

Mid-Berth Television

If installed the mid-berth television requires 120 volts AC. Note that the aft outlet controls the mid-berth television so that breaker at the main ship's panel must be energized for the TV to operate. Follow the same procedure as the cockpit television.

Note that when both televisions are installed they both use the same HDMI BluRay player.

Television Antenna Switch



The television antenna switch (sometimes called the A-B switch) is located above the monitor panel in

the cabin close to the ship's main AC panel. The purpose of the antenna switch is two fold:

At sea- Press the ships antenna or B button. This permits the mushroom television antenna installed on the hard top to find possible TV stations through the use of the antenna and its booster. *Note that In some circumstances you may not be able to receive any type of signal.*

At shore- Press the shore button (A). Now you are using a land signal brought through your coaxial cable.

Sunshade System



Manual bow and cockpit sun shades are available for your 33 SAV. The shades feature fiberglass poles, easy to use fastening system and durable Sunbrella canvas material. The poles are stowed at the port gunnel storage. See photo below.



Television



If installed the cockpit television is located in the aft hard top center locker. Turn the locker latch and the TV will drop down slowly via a hydraulic ram. The cockpit television requires 120 volts.

To activate a television dock side do the following:

1. Ensure that the shore coaxial cable is secured to the coaxial connection inlet at the port transom.
2. Push the antenna shore button in (A). This procedure will bypass the ship's antenna.
3. Activate the aft outlets breaker at the ship's main AC panel located at the cabin stairway.
4. Use the remote and power up the television.

To activate a television at sea do the following:

1. Push the antenna ship's antenna in (B). This will permit the ship's antenna on the hard top to bring in any channels within its range.
2. After energizing the blower start the generator.

Transom Door

The aft transom door provides access to the swim platform and may be useful in certain mooring situations by providing easier access while disembarking.



To open the transom door push the round detent in as far as possible. With your other hand pull the curved portion of the latch out completely and it will release the latch from the receiver plate. To close the transom door push in on the curved end of the latch until the detent snaps outward indicating the latch is closed and locked.



WARNING

AVOID INJURY OR DEATH FROM FALLING OVERBOARD!
ENSURE THAT TRANSOM DOOR IS LOCKED AT ALL TIMES.

Trim Tabs

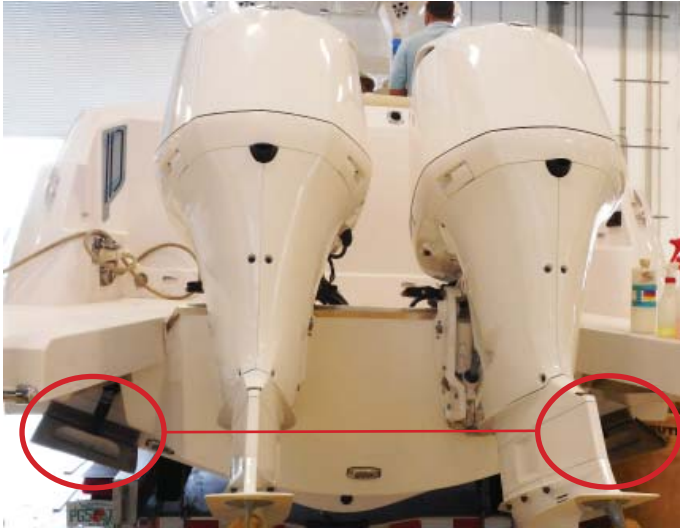

If installed, trim tabs are located on the lower hull of the transom. Water is deflected and redirected as the trim tabs are raised and lowered from the starboard helm located trim tab switch. This change in water flow creates upper pressure under the tabs, and raises the stern. When the stern rises the bow is lowered. Lowering the port tab will cause the port stern to rise, making the starboard bow lower. Lowering the starboard tab will cause the starboard stern to rise, making the port bow lower. The pressure originates from a pump and valve system at the aft bilge.

When used with the engine power trim a fine tuned ride can be achieved. The trim tabs will compensate for uneven weight distribution, listing, water conditions, and other factors that cause inefficient operation. Remember, that trim tabs are trimming the hull while power trim is trimming the outboard(s) drives.

Obtaining A Trimmed Position

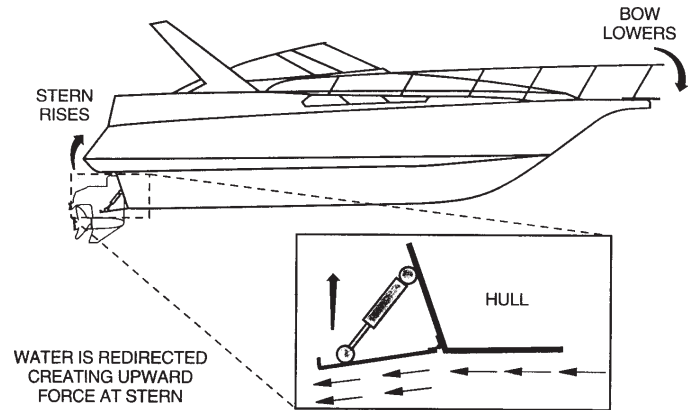

Your vessel will reach a planing position at a specific speed. This speed is determined by bottom design, weight distribution, water conditions, and on board equipment. As the throttle is advanced the stern squats and the bow rises initially. The trim tabs allow your boat to plane at a slower speed than natural conditions allow. *Note a stern drive example above.* In short bursts both trim tab rocker switches are pushed simultaneously in the “bow down” position which causes the trim tabs to move down. As the boat breaks over the bow high attitude the boat speed accelerates and visibility increases.

If the boat is over-trimmed, it will plow the bow and the boat will lose maneuverability. If this occurs, simply short burst the “bow up” trim tab rocker switches simultaneously.

In the “learning curve” process, press the tab switches in half second bursts. You will notice a slight delay from the time the switches are pushed until the boat reacts depending on vessel speed. You will know after awhile the optimum planing angle and speed.

When running in heavy seas press the “bow down” position which will assist the vessel to cut through the waves. This will produce a drier and more comfortable ride. In a following sea run the tabs in a fully retracted angle for maximum drive response. Sometimes you can watch the bow spray or stern wake and the rooster tail (mound of water produced by outboards). In a bow up position the spray is far aft to the hull, the wake is high and the rooster tail is high.

When trimmed or in the bow down position, the bow spray is farther forward, the wake and rooster tail are smaller, and positioned further behind the vessel. Also, when trimmed you will notice that tachometers show an increase in rpm’s.

Rectifying A List

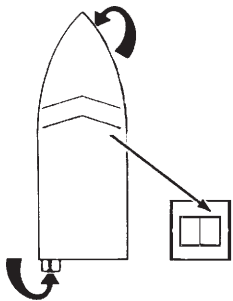

Your vessel can use the trim tabs to rectify a list. The trim tabs adjust the boat's attitude in the direction the helm rocker switch is pushed.

If the port bow is high, push the left-hand “bow down” direction on the dash rocker and the port bow will lower. If the starboard bow is high, push the right-hand “bow down” direction and the starboard bow is lowered.

Using Outboard Power Trim With Trim Tabs

TRIM TABS WITH POWER TRIM

- Trim Tabs Trim Hull
- Power Trim Trims Prop

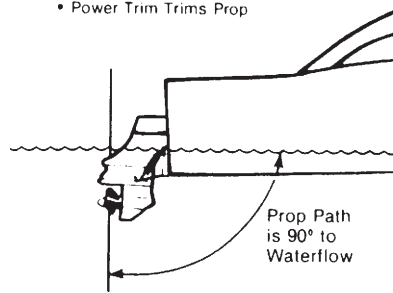

Adjust the trim tabs to achieve a planing attitude. Use the power trim to position the prop path parallel to the water flow. At this point the trim tabs

may need a fine adjustment.

One advantage of the trim tab system is that they allow trimming of the hull while the power trim results in trimming the props.

Note that Illustration shows stern drives vs. outboard drive units.

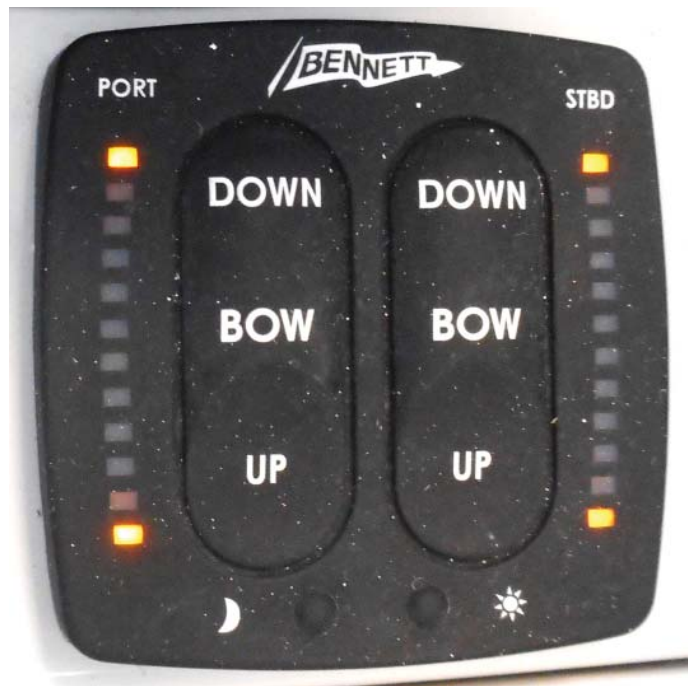

The indicator lights display the relative position of both port and starboard tabs at all times.

Underwater Lights



As an option light bars w/ blue LED clusters make up the underwater lighting system. The lights are located on the transom along with the port and starboard hull sides. There is a dash switch for energizing the lights and a breaker under the dash to protect the system.

Windshield Wiper

A windshield wiper may be installed on your vessel. This wiper features a planographic design which keeps constant pressure on the wiper blade to ensure a more efficient removal of water on each sweep. Note that windshield damage may result if the wiper blade is run over a dry windshield.

Periodically check the wiper blade for excessive wear and replace the wiper blade as needed. It is always a good idea in rain prone environments to store an extra wiper blade on board.

Chapter 8

Care & Maintenance

Cosmetic Care

This section covers the care and maintenance of your Regal boat. Many cosmetic care topics including exterior hardware, upholstery, fiberglass and canvas are covered along with major equipment and systems. Refer to the owner's information packet and the appropriate outboard engine manufacturer's manuals for further detailed instructions.

Upholstery

Cockpit and interior vinyl require periodic cleaning to maintain a neat appearance and to prevent the build up of dirt, mildew and contaminants that may stain and reduce the vinyl life if they are not removed. The frequency of cleaning depends on the amount of use and conditions to which the vinyl is subjected. Most common stains can be cleaned using warm, soapy water and clear rinses. Scrubbing with a soft bristle brush will help loosen soiled material from embossed surfaces and under welting. If the stains are not removed with the above method use a mild cleaner such as Fantastic. This cleaner should be used only as needed and not the normal means.

With more stubborn stains, rubbing alcohol or mineral spirits may be tried cautiously. Widespread solvent use can severely damage or discolor vinyl. Try to remove stains immediately before they have a chance to penetrate the surface of the vinyl.

Powdered abrasives, steel wool, or industrial strength cleaners are not recommended for cleaning our vinyl. Lacquer solvents will cause immediate damage. Dilute chlorine bleach before using. Do not wax the vinyl as it may cause cracking. Always wear protective gloves and make sure there is sufficient ventilation when cleaning vinyl. Wear eye protection.

Remember that suntan oil will damage vinyl. Use suntan lotion instead of suntan oil. Exposure to the sun is a natural enemy of vinyl upholstery. Keep the vessel covered with a cockpit cover when not in use.

Cockpit Carpet

Use approved cleaners on carpet. Always try on a test area first. Many spots and spills can be removed using a cleaner combined with a clean, white terry towel. Try not to soak an area excessively and do not use solvents because most interior carpet is rubber backed and glued in place. Solvents and abrasives will break down the backing and fibers. Note: Always roll up cockpit carpet before towing your boat. Store carpet in a locker.

Plastic

Use plastic cleaners and polishes recommended for marine use only. Use proper applicators. Read all instructions carefully. Test the product in a small area first. Use a soft rag and always rinse the surface with water. Ammonia based cleaners and abrasives will damage plastic parts.

Acrylics

The companionway door is one item made from a heavy acrylic material. Use warm water and a couple drops of mild detergent, The cleaning rag should be lint free and thoroughly rinsed. Do not substitute paper towels, which could lead to fine scratching of the surface. With the right cleaning materials, you can easily remove most dust and grime without creating an additional static discharge.

Do not use an abrasive or scouring pad. Acrylic must not be exposed to organic, oil-based solvents.

This includes:

- Acetone/nail polish remover
- Paint thinner or comparable
- Benzene
- Rubbing, denatured, or other alcohol-based solutions
- Carbon tetrachloride

For scratches and other marks that do not respond to basic cleaning, polishing is the way to renew your acrylic. Again, use a soft, lint-free cloth. You can hand polish or use a polishing machine.

Apply the polish in a snake like S pattern across the surface first horizontally and then vertically. Smaller polish jobs can use an L shape followed by a circular motion. If you are still not able to remove the blemish the scratch is probably too deep. In these situations, the only recourse is an incremental wet sanding, finishing with an #800 grit abrasive, and another coat of polish. After polishing any residual polish should be removed.

NOTICE

AVOID CLEANING PLASTIC SURFACES WITH A DRY CLOTH OR GLASS CLEANING SOLUTIONS CONTAINING AMMONIA. NEVER USE SOLVENTS OR WIPE WITH ABRASIVES.

Interior Fabrics

Clean flat good interior fabrics with dry cleaning fluid style cleaners approved for use with soft fabrics. Allow adequate ventilation and follow the label instructions carefully. Use a soft cleanser with feldspar to clean stubborn marks or stains on wallpaper. Normal interior vinyl such as used on the headliner on cruisers and head clean up with a mild soap and water solution. Rinse immediately with clean water and wipe dry. Always test an area with a cleaner before applying it to a larger area.

Fiberglass & Gel Coat

 **DANGER**

AVOID SERIOUS INJURY!
WAXED GELCOAT SURFACES CAN BE VERY SLIPPERY! DO NOT WAX NORMALLY USED AREAS OF THE DECK, LINER, OR GUNWALES. DO NOT WAX ANY TEXTURED OR NONSKID SURFACES SUCH AS FLOORS, WALKWAYS, STEPS, LADDERS, OR SWIM PLATFORMS. WEAR NON-SLIP FOOTWEAR WHEN WALKING ON VESSEL SURFACES!

NOTICE

WIRE BRUSHES, SCOURING PADS, OR OTHER ABRASIVE TYPE MATERIALS AND SOLUTIONS SHOULD NEVER BE USED ON THE HULL OR DECK. THEY CREATE SMALL SCRATCH THAT COLLECT MARINE GROWTH.

Routine maintenance is the only practical way to keep the surface of your boat looking shiny and new. Most objects left outdoors will gradually deteriorate from exposure to the sun, water, dust and pollution. Such outdoor exposure can cause your boat's gel coated surface to change or fade. Darker colors tend to fade more rapidly than lighter colors because they absorb more of the sun's rays (ultra-violet and infrared).

Basic maintenance includes monthly washing of the boat's surface to remove normal accumulation of soil and stain.

Use a mild detergent such as dishwasher powder or liquid. Do not use automatic dishwasher detergent. Avoid any kind of alkaline cleaners such as trisodium phosphate (TSP), abrasives, bleaches and ammonia. For best results use cleaners that are recommended for fiberglass.

It is recommended that you wax the gel coat surface twice yearly to prevent loss of gloss and to protect the finish. Use only waxes for fiberglass and follow the label instructions. Apply a 3' x 3' section at a time using clean applicator cloths or a buffing bonnet. When a haze develops, use a power buffer at low speeds (1200-2000 rpm) to remove the haze. Keep the buffer moving to avoid heat buildup. The power buffer is very efficient at removing contaminants from gel coat. Never wax gel coat in the direct sun.

When the washing and waxing as recommended does not restore the shine it may be necessary to use a fine rubbing compound. Do not apply rubbing compound in direct sunlight. A power buffer at low speed does an excellent job to remove impurities from the gel coat that cause dulling. Use light pressure and keep the buffer moving. Re-wax after compounding to buff the surface.

“Hairline cracks” or “spider webbing” could develop in the gelcoat surface of a hull or deck. This can be caused by impact or other factors. Small air pockets or gouges may also occur through normal wear.

These do not affect the strength of the hull or deck and can be repaired by yourself, a marine professional or a Regal dealer.

The affected area should be chipped or sanded away and a thin layer of color matched gel coat applied. This layer is then sanded smooth and buffed to its original luster.

Most minor scratches, nicks, and dents can be removed by compounding the surface. Marine type compounds can be found at most auto body supply stores. Specify a number 25 which is a coarser compound up to a number 55 being less coarse. Various glazes and polishes are available as needed. Ask your marine professional or Regal dealer for more information. Fiberglass hulls are strong but they can be damaged. A fiberglass hull has virtually no internal stresses. Thus when a part is broken or punctured, the rest of the hull retains its original shape. A severe blow will either be absorbed or result in a definite localized break. A break of this nature should be checked and repaired by a marine professional or a Regal dealer.

Minor Repairs

You will need the following materials for minor repairs:

- Gel coat
- Clear Liquid Catalyst
- Putty Knife
- Razor Blade
- Fine Sandpaper (400,600,1000)
- Wax Paper (to cover repair area)

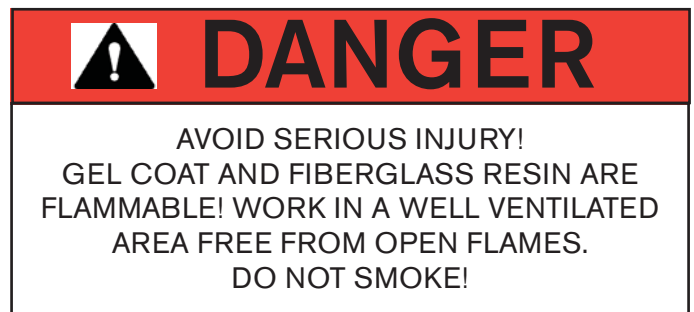

For minor repairs refer to the following procedure:

1. Clean the area to be repaired and get rid of any wax or grease residues.
2. Clean out scratches, chips, and nicks.
3. Sand area to be repaired so gel coat will bond.
4. In a separate container, measure only the amount of gel coat you will need. Mix a ratio of 2% ratio of catalyst to the amount of gel coat being used (a spoonful of gel coat will require only a drop or two of catalyst). Do not pour any unused portions of the gel coat/catalyst mixture back into either original container.

5. Apply gel coat to area leaving a slight lift above the surface.

6. Cover the area with wax paper. It will help the mixture to set up faster.

7. Remove wax paper and shave off any extra gel coat with a razor blade.

8. After the area is shaved smooth, start with the 400, 600, and finally 1000 grit sand papers.

9. Buff the area with compound, polish and a finish wax. You may notice a difference between the repaired area and the original finish due to the natural weathering process.

Canvas

Boat canvas is in most cases subjected to more severe punishment than practically any other type of material. Moisture, dirt and chemicals from industrial fallout, heat, ultraviolet rays and salt water are all factors which accelerate the deterioration of your boat canvas. These elements can cause serious damage if left unchecked.

The boat top and other canvas supplied on your Regal boat are manufactured from top quality materials to provide you with years of trouble free service. The following information on the care, cleaning and proper storage of the fabrics and fasteners that make up your marine canvas is being provided to help you maintain the appearance and ease of operation.

Sunbrella General Information

Sunbrella is used on bow and aft manual sun shades (if installed). Sunbrella is a woven fabric made from 100% solution dyed acrylic fiber. It is color fast and will withstand long term exposure to the sun (ultra-violet rays) without excessive fading.

Even though it is treated with water repellency some "misting" through the fabric is typical. With new canvas, the greatest potential for leakage is through any sewn seams. Because Sunbrella and the long term thread used is synthetic, the holes created by sewing will not swell up and seal when exposed to water as cotton does. Usually the movement of the fabric in use will move the fibers enough to seal the holes. You may apply Apseal or Uniseal to the seams to speed up this process.

When the canvas is new, the fit will normally be tight. It is designed this way because Sunbrella stretches as it ages, The initial tight fit allows for a suitable fit for the life of the canvas. The Sunbrella fit will vary slightly in the heat, cold, and rain.

SUNBRELLA CLEANING INSTRUCTIONS

Sunbrella canvas should be cleaned regularly before substances such as dirt, roof particles, etc., are allowed to accumulate on and become embedded in the fabric. The fabric can be cleaned without being removed from the boat. Simply brush off any loose dirt, hose down, and clean with a mild solution of natural soap in lukewarm water. Rinse thoroughly to remove soap. **DO NOT USE DETERGENTS!** Allow to air dry.

For heavily soiled fabric, remove the top from the frame.

Soak the fabric in a solution that has been mixed to the following proportions.: 1/2 cup of bleach and 1/4 cup of Ivory or Lux soap (liquid or soap) per each gallon of lukewarm water. Allow the fabric to soak until the bleach has killed the mildew and the stains can be brushed out with a common kitchen scrub brush. Rinse the fabric thoroughly in cold water to remove all the soap. This may require several rinsings. Incomplete rinsing can cause deterioration of sewing threads and prohibit the fabric from being properly retreated. Allow the fabric to dry completely. **DO NOT STEAM PRESS OR DRY IN AN ELECTRIC OR GAS DRYER!** Excessive heat can damage and shrink the fabric since it is heat sensitive.

This method of cleaning may remove part of the water and stain repellent that was applied to the fabric during its manufacture. It is recommended to retreat with such water repellency products as Apseal and Uniseal. We do not recommend any wax based treatments such as Thompson's Water Seal or any of the silicone products such as SC-15 or Aqua-Tite. Wax based products prevent the fabric from breathing, and encourage mildew growth while the silicone products interact with the original fluorocarbon finish and seem to cause a rapid loss of water repellency.

Clear Vinyl, Zipper & Snap Care

Never store canvas wet or in an unventilated, moist area. Always roll the canvas instead of folding. This is of particular importance on side curtains or any other part with the clear vinyl "glass". Roll the top carefully around the bows and cover with the storage boot provided.

The clear vinyl "glass" used in side curtains, aft curtains, visors, and camper enclosures is very susceptible to heat and cold. Keep vinyl curtains from touching metal tubing to minimize burning the vinyl. If the boat is stored with top, side curtains and aft curtain in place, heat build up inside the boat may discolor the vinyl. To clean the clear "vinyl" glass, use a solution of Ivory or Lux soap, liquid or flakes, and lukewarm water. Allow to air dry. Never use any type of abrasive cleaner as it will scratch the "vinyl" glass. There are many cleaners and scratch removers on the market specifically for clear vinyl. Handle the clear curtains carefully. They are soft and prone to scratching.

Canvas parts are designed with zippers. When zippers are new they can be a little difficult to use. Zip carefully without forcing the zipper or the material. They will loosen with use. A zipper lubricant may be used to help new zippers as well as maintaining used ones. The most vulnerable part of the zipper is the starts. Use care when beginning to close the zipper.

Canvas snap fasteners should be unsnapped as close to the button as possible. Never remove canvas by pulling roughly on the edge of the material. This can damage the canvas as well as the fasteners. Use petroleum jelly on snaps to keep them from developing corrosion especially in harsh environments.

Metal

Keep all stainless steel and other metal parts rinsed and wiped dry. To maintain their finish annually polish the stainless steel and other bright works at least annually. Use commercially available metal products and read the labels carefully before use.

Refer to the flyer in the owners information pouch.
 Most marinas and boating retail outlets carry metal care products.

Hull Bottom

Never use wire brushes or highly abrasive scouring pads on your hull bottom. It could damage the gel coat surface or the bottom paint. The bottom of your boat needs to be clean since the build up of natural coatings from water or marine life can potentially create drag and affect your boat's performance.

FREQUENT STAINS/CLEAN-UP STEPS	1	2	3
Coffee, Tea, Chocolate.....	B		
Permanent Marker*.....	E	B	C
Household Dirt.....	A	B	
Grease.....	D	B	
Ketchup, Tomato Products.....	A	B	
Latex Paint.....	A	B	
Oil Base Paint.....	D	B	
Mustard.....	A	B	C
Suntan Oil.....	A	B	
Asphalt/Road Tar.....	D	B	
Crayon.....	D	B	
Engine Oil.....	B		
Spray Paint.....	B		
Chewing Gum.....	D	A	
Shoe Polish*.....	D	B	
Ballpoint Pen*.....	E	B	A
Lipstick.....	A	B	
Eyeshadow.....	E	B	
Mildew*.....	C	B	A
Wet Leaves *.....	C	B	A

- A= Soft brush; warm soapy water/rinse/ dry
- B= Fantastik cleaner
- C= One tablespoon ammonia, 1/4 cup of hydrogen peroxide, 3/4 cup of warm water/ rinse/dry
- D= Scrape off residue (use ice to lift gum)
- E= Denatured alcohol/rinse/dry
- * These products contain dyes which leave permanent stains.

Maintenance

Propellers



Out-of-balance and nicked propellers will effect performance or cause vibration. Damaged props should be replaced,

but those that are chipped or bent can usually be reconditioned by a marine dealer or a propeller repair facility. When cruising, consider carrying a spare set of props on board because many marinas do not carry a full inventory of replacement propellers. Also, carry an extra set of prop hardware. Refer to the outboard manufacturer's engine manual for appropriate propeller replacement.

Be sure to make a note of the propeller diameter and pitch while the vessel is in dry dock. They are pressed into the prop for easy reading.

Also, note that propellers feature a rubber hub pressed into the center propeller that includes the hole for the prop shaft to slide through. Sometimes as a result of impact the rubber hub becomes damaged and the propeller will not let the boat perform to the rated revolutions per minute (rpm).

In an emergency a stainless propeller blade may be straightened by laying the propeller blade on a 2 x 4 and hammering the bent portion of the blade until straight. The above process works better with a softer aluminum propeller.

It is advantageous to carry the needed tools to change propellers including pliers to pull cotter key and deep socket and ratchet to remove the propeller shaft nut. See the appropriate outboard manufacturer's owner's manual for further information.

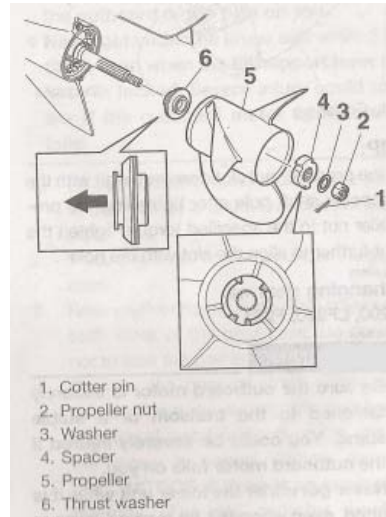

Removing the propeller- Before removing the propeller make sure the remote control is in neutral and the ignition keys are removed to prevent the outboard engine starting and possibly causing bodily injury.

Always wear gloves

when removing or installing propellers since the component blades are very sharp.

1. Use pliers to straighten the cotter key which will permit it to be pulled through the prop shaft.

2. Do not use your hand to hold the propeller while removing the nut.

3. Wedge a 2 x 4 between the skeg and the propeller. Then use a deep socket and ratchet to remove the propeller nut.

4. Next, remove the washer and spacer. Remove the propeller. Remove thrust washer and see note below.

Note: Check the prop shaft seal behind the propeller for fish line and debris that could cut prop shaft seal.

Installing propeller- Before installing parts back on to the prop shaft make sure you lubricate the prop shaft with the recommended lube.

1. Install the thrust washer on the prop shaft first as indicated in the illustration above. Then install the propeller.
2. Align the spacer protrusions with the cutouts of the propeller.
3. Install the spacer, washer, and propeller nut. Tighten the propeller nut to 40 foot pounds with a torque wrench.
4. Next, line up the protrusions on the spacer with the cut outs on the prop itself.
5. Align the propeller nut slot with the prop shaft hole.
6. Install a new cotter key and carefully bend the cotter pin ends over .

Note: Using an old cotter key increases the chances of the propeller working itself off the shaft since the cotter pin ends become stressed and weak after being bent over and constant engine vibration weakens the cotter key ends.

Note: If the prop shaft nut does not line up to insert the cotter key, tighten the nut to the point where it does line up with the prop shaft.

Battery



Frequently check your battery terminals for corrosion build-up. If you find a greenish, powdery substance, remove the cable connections and clean

both the both the terminals and the connectors with a wire brush. When the cleaning is finished reconnect the battery cables and coat the terminal with an approved grease or petroleum jelly to help prevent further corrosion.

Check the electrolyte level at least every 30 days, more often in hot weather. The level should be maintained between the top of the battery plates and the bottom of the fill cap opening.

Add distilled water as needed after charging the batteries or periodically as needed. Do not over-fill because sulfuric acid could run over and cause burns or an explosion.

Batteries should be charged outside the boat. Do not smoke or bring flames near a battery that is being or has recently been charged. The hydrogen gas generated by battery charging is highly explosive. Set batteries on a block of wood rather than concrete since this procedure will help the batteries from losing their charge.

Do not allow a metal object or loose wires to spark across battery posts while working close to the battery. Contact across terminals will cause a short circuit and personal injury may result.

Tighten all battery connectors securely. Check their tightness by pulling on the connectors. They should not move from their tightened position. Be sure to reinstall the positive boot over the battery terminal after tightening the battery post connection. While using the boat, use the volt meter to monitor the charge level of the battery. Monitor the charge with the engines turned off (static condition).

The engine alternators recharge the batteries. A fully charged battery will indicate between 12.3 and 12.6 volts on the voltmeter. Readings below this could indicate a dead battery cell or a charging system malfunction which should be checked by a marine professional.

 **WARNING**

AVOID SERIOUS INJURY!
BATTERIES CONTAIN SULFURIC ACID (POISON) WHICH ALSO CAN CAUSE BURNS. AVOID CONTACT WITH THE SKIN, EYES, AND CLOTHING. IF CONTACTED, FLUSH WITH WATER FOR AT LEAST 15 MINUTES. IF SWALLOWED, DRINK LARGE AMOUNTS OF WATER, OR MILK. FOLLOW UP WITH MILK OF MAGNESIA, BEATEN EGG, OR VEGETABLE OIL. GET MEDICAL ATTENTION IMMEDIATELY!

 **WARNING**

AVOID SERIOUS INJURY!
WEAR GOGGLES, RUBBER GLOVES, AND A PROTECTIVE APRON WHEN WORKING WITH A BATTERY. BATTERY ELECTROLYTE CAUSES SEVERE EYE DAMAGE AND SKIN BURNS. IN CASE OF SPILLAGE, WASH AREA WITH A SOLUTION OF BAKING SODA AND WATER.

Remote Control



Check the helm control box and make sure there is no roughness or tightness when shifting. Also, check to make sure the control box hardware is tightly secured. The

shifting is done by a process called “fly by wire” Being the engines use electronics to shift it should be effortless. An application of silicone spray on the handles will help fight any corrosion. Remember there are no actual mechanical shift and throttle control cables on your vessel. There is a friction control which may be altered to personal needs. Contact your closest Regal outboard dealer for further assistance or a marine professional.

Seating

Care of your seating includes periodic cleaning with products which are non-corrosive and are recommended for vinyl. Select seats use rams and hardware which needs to be periodically checked for tightness. See the cleaning vinyl for more information.

Fuel System

At least annually inspect all fuel system components for loose clamps at the vent, fill and feed locations. Examine each hose for signs of deterioration and leakage. Check the fuel sender for loose bolts, nuts, and leaks at all areas of contact. Also, inspect the fuel tank for signs of leakage or abrasion. Tighten all components as needed.

 **WARNING**

AVOID SERIOUS INJURY OR DEATH DUE TO
FIRE OR EXPLOSION RESULTING FROM
LEAKING FUEL!
INSPECT ENTIRE FUEL SYSTEM
AT LEAST ONCE PER YEAR.

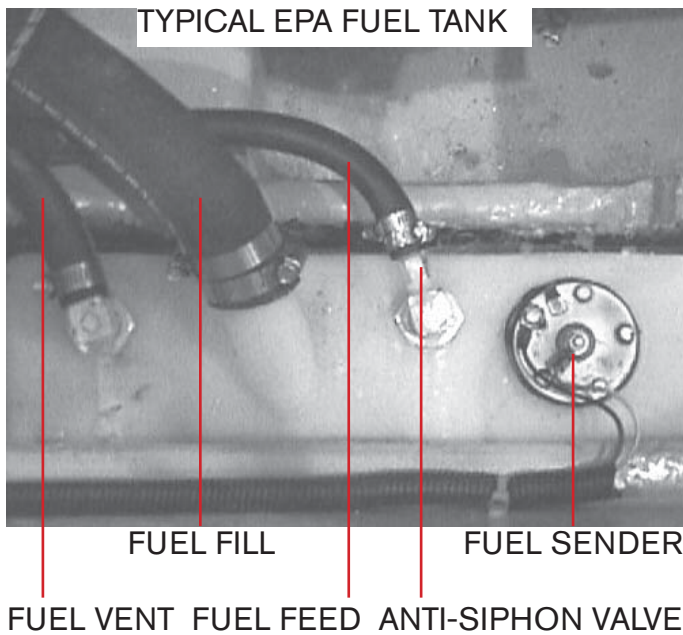

Stereo

The Fusion® stereo head unit requires little maintenance. When washing the cockpit, do not discharge water directly at the stereo unit. Possible damage may result. As with any CD unit clean your CD's to keep them from skipping. This process also aids in keeping dust out of the unit. For further information, refer to your stereo owner's manual located in the owner's packet.

Galvanic Corrosion/Stray Current

Metal parts underwater can be subjected to two basic styles of electrolysis: galvanic corrosion and stray current corrosion. Both can damage the outboard drive, propeller, underwater parts, boat and motor if not correctly monitored (testing at 2 week intervals) and avoided.

Galvanic corrosion is an electrochemical reaction between two or more metals. Drive systems consist of several different metals. Some are more active than others.

Galvanic corrosion of the more chemically active metals can occur whenever two or more dissimilar metals that are “grounded” (connected by actually touching each other, or through a wire or metal part) are immersed in a conductive solution (any material that can conduct electricity). Anything but pure water is conductive. Saltwater, fresh water with a high mineral content and polluted freshwater are highly conductive. Conductivity increases with temperature. That is why Florida boats experience more corrosion than boats in Maine.

Specifically look at a typical outboard marine drive unit with a stainless steel propeller. The aluminum is the more chemically active metal (called the anode) and the stainless steel propeller is the less chemically active metal (called the cathode).

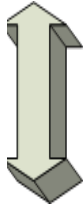
CORROSION TABLE	
Gold	 <p>Least Active</p> <p>Most Active</p>
Stainless Steel	
Bronze	
Copper	
Brass	
Steel	
Aluminum	
Zinc	
Magnesium	

Typically electrons flow from the anode (the aluminum drive unit), via the external conducting path to the cathode (stainless steel propeller). If there is a very large anode connected to a small cathode, the anode will corrode very slowly. If a very large cathode is connected to a small anode, the anode will corrode very quickly. Obviously, if you do not control galvanic corrosion, over time the aluminum will corrode away.

The first sign of galvanic corrosion is paint blistering (starting on sharp edges) below the water line- a white powdery substance forms on the exposed metal areas. As the corrosion advances, the exposed metal will become deeply pitted as the metal is actually eaten away.

Another condition which will increase galvanic corrosion is the removal or reduction in surface area of the sacrificial anodes. Never add aftermarket products that are connected to the engine ground such as stainless steel steering aids and trim planes. Zinc connected to aluminum will form a corrosion cell but the aluminum (drive) becomes the cathode and the zinc (anode) corrodes.

Even though your boat may not have shore power aboard current from nearby vessels with shore power can produce stray current galvanic corrosion. Stray current corrosion occurs when metal with an electrical current flowing into it is immersed in water that is grounded (lake, ocean, pond). The current can leave the metal and flow through the water to ground. This will cause rapid corrosion of the metal at the point where the current leaves.

When a vessel nearby is plugged into shore power, they can potentially tie your outboard drive unit to their boat via the green grounding shore power lead. Your outboard drive unit could be the receiving end of a large galvanic cell (a battery) interconnected with nearby vessels or even through the marina's metal structures via their electrical system.

The vessel should be tested every couple of weeks to determine the integrity of the anode protection system. Another way to test the system is to measure the hull potential. This is accomplished by immersing a reference electrode, usually a silver/silver chloride into the water about six inches behind the outboard drive. With leads attached to a digital multi-meter the hull potential is read on the DC scale and compared to recommended specifications for the water body type. See the owner's information vendor packet for more information or contact your nearest authorized Regal dealer.

Tips To Aid In Maintaining Galvanic Integrity

1. Test the galvanic integrity of your vessel every 2 weeks. Raise the drive and inspect anodes/parts for signs of galvanic corrosion, stray current corrosion or loose fasteners. Contact your closest Regal dealer/marine professional where signs of galvanic corrosion exist.
2. Never paint over anodes as they will become inoperative. Always leave at least one inch between bottom paint and any underwater fitting such as sea cocks, swim platform stanchions and all drive and propulsion related underwater parts.

3. Periodically remove vessel from water and clean/pressure wash all outboard, anode and hull bottom areas to remove growth.

4. Ensure vessel is using the correct anode metal for the body of water that it is moored. See the outboard engine manufacturer's manual for more information or contact an authorized dealer.

5. Ensure that the drive is completely "in" down to provide more complete anode protection when vessel is moored.

6. Do not attempt to use magnesium anodes in saltwater. They will provide over protection.

7. If marina moored, contact appropriate personnel if signs of galvanic corrosion appear on your drive system. Ask them to check for stray electrical current which may be originating from a nearby vessel's faulty DC wiring or from a marina pier, piling or dock carrying leaking marina ground wiring such as a dock side cord partially submerged.

GALVANIC/STRAY CURRENT CORROSION	
Cause/Observed Condition	Corrective Action
Sacrificial anodes consumed	Replace anodes when 30% consumed
Sacrificial anodes not grounded to drive	Remove anodes, clean contact surface, reinstall, check for continuity
Loss of continuity between underwater parts & ground	Provide good ground connections
Nearby vessel with stray current	Contact appropriate personnel Remove your vessel from water
Paint on drive heavily worn, exposing more metal	Prime and repaint or install additional anodes
Sacrificial anodes painted	Remove paint or replace anodes
Drive tilted/anodes out of water	Leave drive down, install additional anodes below water
Power trim cylinders only corroded	Provide a good ground to drive, all parts must be grounded
Corrosion in area of exhaust outlets	Remove deposits
Corrosion occurring after vessel is removed from saltwater	Wash exterior and flush interior with freshwater
Stainless steel parts corroding	Clean parts, remove foreign material, ensure continuity
Underwater drive parts corroded, sacrificial anodes OK	Oxide film on anode (fresh water only) Replace anode Poor ground. Scrape anode

Zinc Anodes



Sacrificial zinc anodes are located on the outboard drive housing, trim cylinders and/or prop shaft to protect softer metals exposed to the water. Electrolysis attacks the least noble metals first. Because zinc is a less noble metal, it will decompose before other metals. Check these zinc

anodes periodically and have them replaced when they are 30% consumed. Notwithstanding, zinc is the most popular metal used to protect parts that are exposed to saltwater, freshwater or brackish water. See the photos below for anode location on your outboard.

Zinc anodes in brackish or salt water need to be checked more frequently. If the anodes seem to be requiring frequent replacement there may be a boat leaking DC current into the water taxing the anodes. This is especially possible around a marina environment. Contact a marine professional who can measure the galvanic activity with a special electrode and electric VOA meter. Refer to the engine manufacturer's manual for exact anode location and detailed information.

Inspect the ground leads for tightness if attached.

Note that parts damage due to galvanic or stray current corrosion is not covered under warranty.

Outboard Engine Maintenance

A select portion of maintenance items are covered in this chapter. Since advanced ignition and fuel injection systems are used on outboard engines along with special factory training and tools it is best to contact your Regal dealer for more of the detailed outboard service procedures.



CAUTION

AVOID ENGINE DAMAGE!
FOLLOW ALL BREAK-IN PROCEDURES RECOMMENDED BY THE ENGINE MANUFACTURER. FAILURE TO FOLLOW BREAK-IN PROCEDURES MAY VOID THE OUTBOARD ENGINE WARRANTY.



CAUTION

AVOID ENGINE DAMAGE!
DO NOT RUN OUTBOARD ENGINE AT A CONSTANT RPM FOR PROLONGED PERIODS OF TIME DURING BREAK-IN PERIOD. CHECK ENGINE OIL OFTEN.



CAUTION

AVOID ENGINE DAMAGE!
DO NOT RUN OUTBOARD ENGINE OUT OF WATER UNLESS YOU USE AN OPTIONAL FLUSHETTE. FOLLOW MANUFACTURER'S ATTACHING AND RUNNING INSTRUCTIONS!

Fuses- Electric Cover Plate



As part of Yamaha outboards under the motor shroud (engine cover) on the port side of the outboard engine is an electrical cover

plate. Inside this cover is a variety of fuses protecting various engine components. There are also extra fuses stored along with a fuse puller. For further information, refer to the manufacturer's outboard engine manual.

Checking Fuel System Water Separator Filter



Periodically before embarking on a cruise check the fuel filters. A 10 micron in-line water separator filter for each engine is installed in the aft bilge. Use an oil spanner type wrench and turn the filter

counterclockwise to remove the element. With a clean pan empty the filter contents into the pan. Water in fuel tends to hug the bottom and will show a different color than the fuel. At least yearly or on an as needed basis replace the filter element. Fill the element up with fresh unleaded fuel of the correct octane rating and turn it clockwise until tight. Finish tightening with the spanner wrench. As always check for leaks before starting the engine.

It is a great idea to keep extra filter elements on board in protective wrap for emergency use.

Checking Engine Mounted Fuel Filter

As part of select outboards under the motor shroud (engine cover) on the lower port side of the outboard engine is a fuel filter. Periodically check to ensure the fuel filter is clean and free of water. When reinstalling the filter tighten to manufacturer's specifications. Check for leaks after starting the engine. For more information refer to the outboard manufacturer's owners manual or contact a Regal dealer or marine professional.



Flushing Device

Your Yamaha outboard features a flushing device which when connected to a garden hose circulates fresh water through the engine to purge unwanted debris such as found in salty, brackish, and silty water.

To use open the flushing device by turning it counterclockwise. Notice there is a garden hose bib thread. Attach the male end of a garden hose to the fitting and tighten it. Make sure the fitting does not leak as the power head could overheat and cause internal damage. It is best to perform this flushing procedure with the engine still warm from a cruise as the thermostat will be open and will permit more efficient water circulation. Turn on the fresh water supply. When flushing completed remove the garden hose from the fitting and reattach the hose connections and of course check for tightness.

Note not to start engine during this procedure as overheating and engine damage may occur.

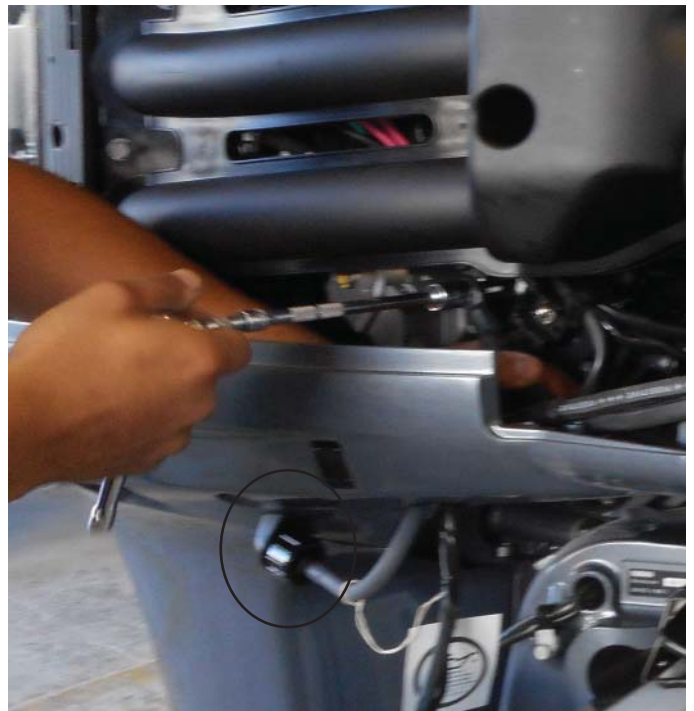

Checking Engine Crankcase Oil

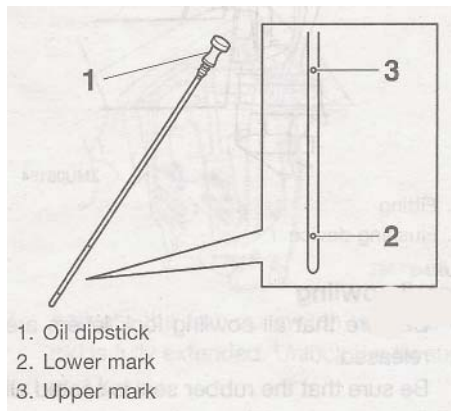

Your Yamaha outboard features 4 cycle engine operation. Unlike 2 cycle outboards which mix gas with oil technology, the 4 cycle engine uses crankcase 4 cycle oil to lubricate internal moving parts. This operation is similar to automobile engine technology. As part of this process, there is a dipstick placed in the crankcase to offer periodic checking of engine crankcase oil.

To check the crankcase oil do the following:

1. Ensure the outboard is setting in a flat vertical position or the dipstick may not display an accurate oil level.
2. Remove the crankcase oil dipstick and wipe it clean.
3. Reinstall the crankcase oil dipstick completely into the hole. Remove it again.
4. The oil level should be between the upper and lower dipstick holes. .As needed add the manufacturer's recommended oil or contact your closest dealer especially if the oil is contaminated with water which will show a milky color verses a clear look. Refer to the outboard manufacturer's owners manual for oil changing maintenance schedules.

Checking/Filling Crankcase Oil- (Cont.)

When adding crankcase oil be sure to utilize the manufacturer's recommended type and viscosity. For changing crankcase oil contact your closest Regal dealer for additional information since they have the special tools and knowledge for these maintenance procedures.



Chapter 9

Troubleshooting

The following diagnostic information will assist you in identifying minor electrical, fuel, and mechanical problems. Some of the items listed require technical training and tools. Additional assistance is available in the outboard engine manufacturer's owner's manual. Also, you can contact your closest Regal dealer or marine professional for more information. Sometimes a problem can be solved by performing a logical sequence of elimination and/or root cause techniques.



WARNING

AVOID SERIOUS INJURY OR DEATH!
BEFORE PERFORMING ANY MAINTENANCE
WORK, TURN OFF THE BATTERY SWITCH
AND REMOVE THE IGNITION KEY
FROM THE SWITCH.



WARNING

AVOID SERIOUS INJURY OR DEATH!
USE ONLY APPROVED MARINE
REPLACEMENT PARTS THAT
ARE IGNITION PROTECTED.

OUTBOARD ENGINE DIAGNOSTIC CHART

Problem	Possible Cause
Engine Overheating	<p>Water pick-up feeds are blocked by debris</p> <p>Cooling system leak</p> <p>Impeller is worn or blocked by debris</p> <p>Propeller is over propped for the circumstances, causing the engine to work extra hard</p> <p>Debris in oil is holding heat more than normal - bad oil filter</p> <p>Defective thermostat.</p>
Starter Will Not Crank	<p>Battery weak or dead</p> <p>Starter defective</p> <p>Fuse for electric start relay blown</p> <p>Control not in neutral</p> <p>Defective start panel button</p>
Excessive Steering Play	<p>Air in steering lines (Bleed)</p> <p>System low on steering fluid</p> <p>Mechanical parts-loose connection</p>

OUTBOARD ENGINE DIAGNOSTIC CHART

Problem	Possible Cause
No Power To Helm	Battery switch turned off Batteries are weak or dead. Main breaker tripped Loose connection
Engine Cranks But Will Not Start	Fuel flow obstructed/water in fuel Low battery voltage Engine ignition system malfunction Timing belt broken No fuel in tank Lanyard not attached Control not in neutral
Hard Starting	Vacuum In Fuel System Fuel lines obstructed Water in fuel Debris in fuel/clogged fuel filter
Engine Idles/ Runs Rough	Old fuel Faulty spark plugs Fuel contaminated/ clogged anti-siphon

OUTBOARD ENGINE DIAGNOSTIC CHART

Problem	Possible Cause
Power Loss	Damaged propeller Improper trim angle Spark plugs fouled Fuel system malfunction Hull bottom fouled with debris Excess water in bilge (leak)
Excessive Vibration	Damaged propeller Damaged propeller shaft Loose/broken motor mount Steering pivot loose or damaged Debris caught on propeller Ignition malfunction Motor mount bolts loose (transom)

OUTBOARD ENGINE DIAGNOSTIC CHART

Problem	Possible Cause
Buzzer Sounds/Icon Lights	Cooling system malfunction Engine oil level low or incorrect type Wrong spark plug heat range Oil feed pump malfunction

DC ELECTRICAL SYSTEM DIAGNOSTIC CHART

Problem	Possible Cause
No 12 Volt Power At Battery	Battery switch turned off Weak or dead battery Battery cables loose/disconnected
Battery Not Charging While Engine Is Running	Faulty stator Faulty circuit wiring
Battery Will Not Hold Charge	Faulty/ old battery Loose battery cables Corroded battery terminals
12 Volt Equipment Not Working	Fuse blown-Take time to investigate why the equipment was drawing too much current or why it had a short circuit. Check fuses at fuse block and under the engine shroud Weak or dead battery if all 12 volt equipment fails to function. Corroded / loose wire connection Internal equipment short /failure

AC ELECTRICAL SYSTEM DIAGNOSTIC CHART

Problem	Possible Cause
No Voltage At Main AC Panel	Ships dock side cord not plugged in Dock side breaker tripped ELCI breaker tripped Faulty dock side power cord
AC Panel Indicates Reverse Polarity	Dockside wires reversed at marina power supply.
No Voltage At GFCI outlets	GFCI outlet tripped (reset) Outlet breaker off at AC main ship's panel Unplug faulty equipment-short
Main AC Panel Breakers Trip When All Equipment Is Energized	Turn off equipment as needed to balance load on shore 1 and shore 2

Chapter 10

Storage & Winterization

Storage procedures are outlined in this chapter. These are general guidelines to follow before longer periods such as over the winter in colder climates. Be sure to familiarize yourself with all relevant information in the owner's sacht.

Special winterization procedures are necessary for the boat equipment and systems. Use the enclosed checklists to help you identify areas of concern and maintenance. Call a Regal dealer or marine professional for further information regarding storage/maintenance procedures. Also, more specific information can be found in the outboard engine manufacturers owners manual.



WARNING

AVOID SERIOUS INJURY OR DEATH
DUE TO FIRE AND EXPLOSION!
DO NOT FILL FUEL TANK TO RATED
CAPACITY. LEAVE ROOM FOR EXPANSION.

NOTICE

REMOVE BATTERIES WHEN VESSEL
IS IN LONG PERIODS OF STORAGE
ESPECIALLY IN COLD CLIMATES
BATTERIES CAN FREEZE AND POSSIBLY
LOSE ELECTROLYTE.

NOTICE

AVOID SERIOUS OUTBOARD ENGINE
DAMAGE! USE ONLY FACTORY APPROVED
PRODUCTS FOR OUTBOARD ENGINE AND
DRIVE DURING STORAGE PERIODS.

Decommissioning Checklist

Outboard Engine Winterization/Maintenance

- Run engine. Pour approved fuel stabilizer/conditioner in the fuel tank. Allow time for it to circulate through the fuel system.
- Change all engine fluids as referenced in the outboard engine manufacturer's owners manual. Contact a Regal dealer.
- Check outboard engine hoses, clamps, and system wiring for loose connections, abrasion, and corrosion.
- Spray all exterior parts with a rust preventative.
 - Perform maintenance as referenced in the outboard manufacturer's owners manual. Contact your Regal dealer.
- Remove propeller. Refurbish as needed.

Outboard Engine Care

- After cleaning use touch up paint on unit as needed.
- Apply coat of wax to outboard shroud and exterior parts.

Boat

- Check hull bottom for any fiberglass damage.
- After cleaning apply a coat of wax to hull and deck surfaces.

- Pour a pint of 50/50 antifreeze into bilge pump.
- Never block up boat bottom. May cause structural damage.

- Remove batteries. Use a trickle charger as needed.
- Remove all loose gear and electronics from boat. Inspect all equipment for wear and damage. Store in a clean, dry environment.
- Remove drain plug. Clean drain plug hole of debris as needed. Enclose drain plug in plastic bag and tie to steering wheel.
- Make sure bow is higher than stern to permit proper drainage.
- Clean all upholstery and store so it breathes.
- Conduct a visual inspection to ensure boat is balanced properly on the trailer, cradle or blocks.
- Cover boat with appropriate cover. Tie down for protection from rain, snow and/or wind. Prop up cover to provide proper ventilation. Do not cover up the fuel vents.
- Drain the fresh water system per instructions in this chapter.
- Use sling locations for lifting boat via Chapter 12 drawing.

Trailer

- Repack all wheel bearings per manufacturer's specifications.
- Check all trailer parts for excessive wear. Replace/ refurbish as needed.
- Use touch up paint on trailer as needed.

Typical Fresh Water System

1. Activate the fresh water pump switch.
2. Open all faucets including transom shower (if equipped) and allow tank to empty.
3. Drain the water tank. Shut off fresh water pump switch.
4. Mix nontoxic antifreeze with water in accordance with the manufacturer's recommendations. (Available at marina & RV stores)
5. Pour solution into the fresh water tank.
6. Turn on fresh water pump switch.
7. Open water faucet and purge until a steady stream of nontoxic antifreeze flows from the faucet. If equipped, do the same to the transom shower. Turn the fresh water switch to the "off" position.

Waste System

1. With chemical heads, make sure to dump both upper and lower tanks. Rinse well with fresh water. Sanitize chemical head as needed.
2. With electric head, pump out holding tank. Add nontoxic antifreeze to toilet and holding tank. Pump from toilet to holding tank to eliminate any water remaining in supply lines.

NOTICE

AVOID VESSEL AND/OR OUTBOARD ENGINE DAMAGE! CONTACT A MARINE PROFESSIONAL FOR WINTERIZATION ASSISTANCE. DAMAGE CAUSED BY IMPROPER WINTERIZATION IS NOT COVERED BY VESSEL OR OUTBOARD ENGINE MANUFACTURER.

Recommissioning Checklist

Engine

- Check all components per outboard engine manufacturer's owner's manual especially fluid levels.
- Run engine on "ear muffs" (flushette) before launching. Check for fuel, exhaust, oil, and water leaks.

Boat

- Install drain plug.
- Install battery and tighten all terminals.
- Check all equipment, switches, alarms, gauges and breakers for proper operation.
- Add necessary chemicals and water to chemical head.
- Add water to fresh water tank. Turn on faucet to purge tank. Refill water tank.
- Make sure all safety gear is on board and in excellent working condition.
- After launching, check controls and gauges for proper operation.

Trailer

- Make sure all equipment is in excellent working condition.

Chapter 11

Glossary & Index

Below is a brief list of nautical terminology. For more detailed glossaries we recommend you check your local library, book retailer, marine store or internet.

Glossary

Abeam: at right angles to the fore and aft line and off the boat

Aboard: on or in the boat

Above:the part of the boat on a vessel which is above the interior of the boat

Aft, After:: aft is the boat section toward the stern or back of the boat

Amidships: toward the center of the boat from either side to side or rear to front

Beam: the width of a boat at its widest part

Bilge: the lower interior of the hull of the boat

Bitter end: the end of a line also the end of an anchor line

Bow: the front, or forward part of the boat

Bulkhead: the vertical partition or wall of a boat

Cast off: to let go or release

Chine: the line fore and aft formed by the intersection of the side and bottom of the boat

Chock: deck fitting used to secure or guide anchor or tie lines

Cleat: deck fitting with protruding arms around which lines are secured

Cockpit: the seating space used to accommodate passengers

Cuddy: a small cabin in the fore part of the boat

Deck: the open flooring surface on which crew and passengers walk

Draft: the depth from the waterline of the boat to the lowest part of the boat, which indicates how much water is required to float the boat

FasTrac- a proven hull bottom design which incorporates a full, mid-beam step that reduces drag by forcing air under the hull to decrease drag and friction.

Fathom: a measurement of depth; one fathom equals six feet

Fender: a cushion hung from the side of a boat to prevent it from rubbing against a dock or against other boats.

Fend off: to push off to avoid sharp contact with dock or other vessel

Fore: the part of the boat toward the bow or front

Freeboard: the height of the top side from the waterline to the deck at its shortest point (The distance from sheer or gunwale to the water).

Gunwale: rail or upper edge of the side of the boat

Head: toilet

Hull: the part of the hull from the deck down

Keel: the lowest point of a boat; the backbone of the vessel

Knots: a measurement of speed indicating nautical miles per hour

Lee: the side opposite that from which the wind is blowing; the side sheltered from the wind

Leeward: the direction toward which the wind is blowing

PFD: personal flotation device; required for each person aboard

Port: the left side of the boat when facing forward (an easy way to remember the difference between "port" and "starboard" is that both "port" and "left" have four letters)

Shank: the main body of an anchor

Sheer: the curve of the boat's deck from fore to aft when seen from the side

Starboard: the right side of the boat when facing forward

Stern: the aft end of the boat

Stern drive: an inboard/outboard (I/O) unit

Stringer: strengthening integral unit fastened from fore to aft inside the hull and fiberglass encapsulated for added strength: much like the skeleton system of our body

INDEX

A		C	
Accidents	37	California EVAP Regulation	2
Accident Reporting	37	California Spark Ignition Warranty Info	2
Acrylics	174	Canvas	156
Anchor Light	29	Carbon Monoxide	33
	123	Cardiopulmonary Resuscitation	147
Anchor Windlass	149	Cockpit Sea grass Mat	159
Anchoring	143	Controls	129
Audible Alarms	118		182
Automatic Fire Extinguisher	51	D	
B		Dealer Responsibilities	12
Battery	57	Decommissioning	199
	181	Direct Current Protection	59
Battery Charger	60	Distress Signals	26
Battery Switch	59	Diver's Flag	39
Bilge Pump	152	Docking	137
Boating Under The Influence	36	Drain Plug	136
Bottom Blocking	199	E	
Bow Table	153	EPIRB	11
Bow Thruster	154	Electrical	53
Bridge Clearance	48	Emergencies	146
Buoys & Mark		Engine-Outboard Basics	116
		Engine-Starting	129
		Environmental Awareness	148
		Exhaust	33

F		I	
Fenders	139	Ignition Panel/Switch	128
Fiberglass	175	Index	205
Filters	97	Instruments	123
Fire Extinguishers	24	Interior Fabrics	175
First Aid	147	Interrupter Switch	131
Fishing	37		
Float Plan	9	K	
Fueling	137	Knots	146
	183		
	188	L	
Fuel System	95	Labels	18
Fuse Panel (DC)	63	Ladder	39
		Lighting	124
G		Life Raft	32
GFCI	80	Loading	20
Galvanic Corrosion	184		21
Galvanic Isolator	83		215
Garbage Placard	31	Law Of Salvage	145
Gel coat Maintenance	175	Lubrication-Engine	121
General Boating Safety	19		188
Getting Underway	136	Lubrication- Gear case	121
Glossary	203		
Grill	157	M	
		Maneuvering	139
H		Maintaining PFD'S	24
		Masthead Light	123
Helm Controls	122	Metal Cleaning	178
HIN	7	Minimum Required Equipment	32
Horn	28		
	123		
Hull Bottom	179		
	199		
Hypothermia	147		

N		S	
Navigational Aids	45	Safety Labels	18
Navigation Lights	32	SeaDek	163
Navigation Rules	41	Seating	20
Neutral Safety Switch	131		215
Night Running	48	Shallow Water Operation	143
		Shifting-Remote Control	130
O		Signals-Navigation	42
Oil Spills	30	Sound Producing Devices	28
Overloading	20	Spring Line	138
		Stopping	141
Owner's Information Packet	7	Stern Line	137
Owner's Registration	11	Stereo	166
Owner's Responsibilities	12		
		T	
P		Table Of Contents	5
Personal Flotation Devices	22	Tachometer	124
Plastics	173	Technical	209
Pollution Regulations	30	Toilet	104
Power Trim	131	Towing	145
	142	Trim Angle	142
	171		144
Pre-departure questionnaire	136	Trim Indicators	171
Propellers	122	Trim Tabs	170
	179	Troubleshooting	191
R		U	
Radio Communications	28	Underwater Lighting	172
Recommissioning	202	Upholstery	173
Remote Stereo Control	162		
Required Safety Equipment	22		
Right Of Way	44		
Rules Of The Road	41		

V

Ventilation	33
Visual Distress Signals	26

W

Water Sports	39
Warning Labels	18
Warranty	14
Weather	40
Windshield Wiper	172
Winterizing	198
Wiring Color Codes	54

Y

Yacht Plate	7
-------------	---

Z

Zinc Anodes	187
-------------	-----

Chapter 12

Technical

NOTICE



The following technical information and drawings can be an aid in troubleshooting electrical and mechanical problems along with the charts located in the troubleshooting chapter.

Note that all product specifications, models, standard and optional equipment, systems, along with technical information is subject to change without notice.

For more information contact your nearest authorized Regal dealer. For the location of your nearest authorized dealer call 407-851-4360 or visit the web-site at www.Regalboats.com.

Your Regal dealer has received special factory training on the entire product line and his services should be employed to solve technical problems.

TYPICAL DOMESTIC COMPLIANT FUEL SYSTEM

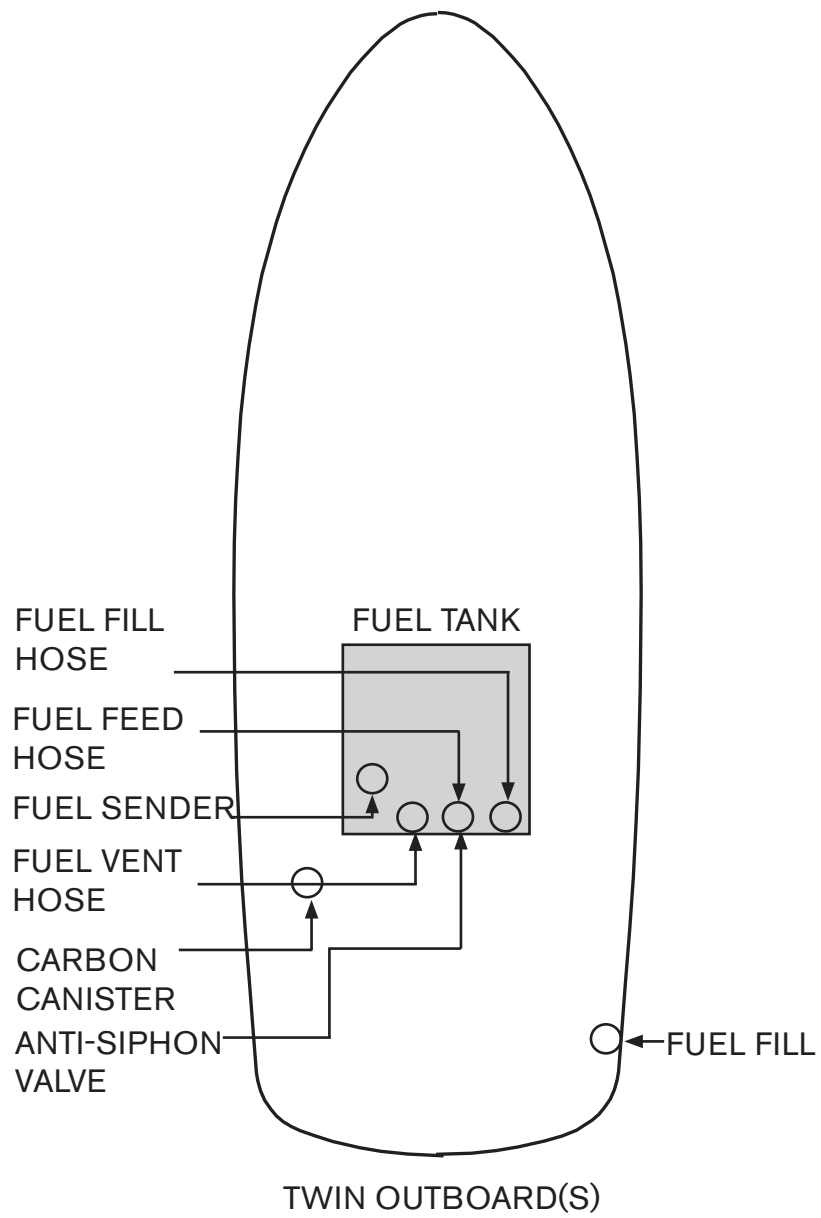

TYPICAL LABELS & LOCATIONS

WARNING
USE PROPER BLOCKING TECHNIQUES
WHEN LIFTING BOAT

NOTICE
Retrieval of Windlass Chain
Winch operator may be required
to periodically spread chain out
within anchor locker



WARNING
AVOID SERIOUS INJURY OR DEATH
FROM FIRE OR EXPLOSION
RESULTING FROM LEAKING FUEL.
INSPECT SYSTEM FOR LEAKS AT
LEAST ONCE A YEAR.

WARNING
ROTATING PROPELLER(S) MAY CAUSE
SERIOUS INJURY OR DEATH!
DO NOT APPROACH OR USE LADDER
WHEN ENGINE IS RUNNING.

WARNING
Electrical shock and fire hazard. Failure
to follow these instructions may result in
injury or death.
(1) Turn off the boat's shore power
connection switch before connecting or
disconnecting the shore power cable.
(2) Connect the shore power cable to the
boat first.
(3) If polarity-warning indicator is
activated, immediately disconnect cable.
(4) Disconnect shore power cable at shore
outlet first.
(5) Close shore power inlet cover tightly.
**DO NOT ALTER SHORE
POWER CABLE CONNECTORS**

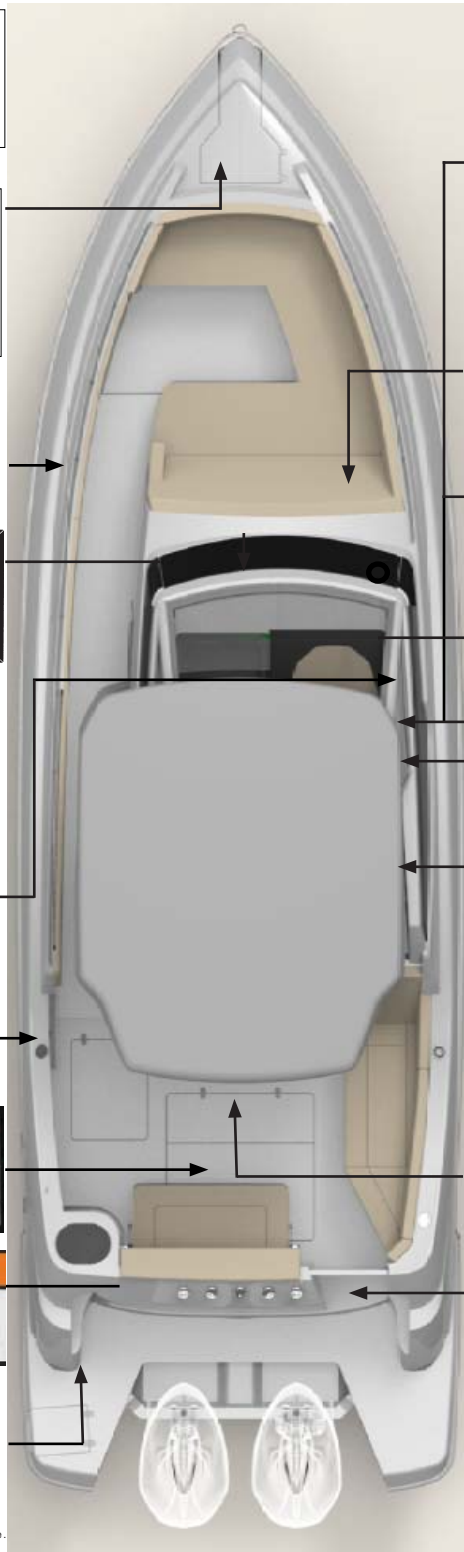

WARNING
ROTATING PROPELLER MAY CAUSE
SERIOUS INJURY OR DEATH.
SHUT OFF ENGINE WHEN
NEAR PERSONS IN THE WATER.
NW-207-08

WARNING
Carbon monoxide (CO) can cause brain damage or death.
Engine and generator exhaust contains odorless and colorless carbon monoxide gas.
Signs of carbon monoxide poisoning include nausea, headache, dizziness, drowsiness,
and lack of consciousness.
Get fresh air if anyone shows signs of carbon monoxide poisoning.
See Owner's Manual for information regarding carbon monoxide poisoning.

WARNING
GASOLINE VAPORS CAN EXPLODE BEFORE STARTING
ENGINE. OPERATE BLOWER 4 MIN. AND CHECK ENGINE
COMPARTMENT FOR GASOLINE LEAKS OR VAPORS. RUN
BLOWER BELOW CRUISING SPEED.

MEETS U.S. EPA EVAP
STANDARDS USING
CERTIFIED COMPONENTS
REGAL MARINE INC., ORLANDO, FL



WARNING
AVOID PERSONAL INJURY!
INTERRUPT SWITCH MUST BE ATTACHED TO OPERATOR
WHILE ENGINE IS RUNNING. QUALIFIED OPERATOR MUST
BE IN CONTROL AT ALL TIMES.
READ OWNER'S MANUAL BEFORE USE.

WARNING
CARBON MONOXIDE IS A TASTELESS, ODORLESS, AND
INVISIBLE GAS THAT CAN CAUSE DISCOMFORT, SEVERE
AND EVEN DEATH. EXERCISE CAUTION WHILE OPERATING
A GENERATOR OR ENGINE IN CONFINED SPACES OR AT
DOCK SIDE. DO NOT ALLOW HULL EXHAUST OUTLETS TO
BECOME BLOCKED OR EXHAUST FUMES CAN BECOME
TRAPPED IN OR AROUND THE CONFINES OF YOUR VESSEL.

THE DISCHARGE OF ALL FORMS OF PLASTIC INTO ALL WATERS IS PROHIBITED
THE DISCHARGE OF ALL GARBAGE IS PROHIBITED
into the navigable waters of the United States, and into all other waters except as specifically allowed.
ALLOWED: 3 to 12 nautical miles from land – Food waste ground to pass through a one-inch
mesh screen.
ALLOWED: 12 or more nautical miles from land – Food waste ground as above, and waste
water, and cleaning agents, en route as far from shore as practicable, that are not
harmful to the marine environment.
MARPOL ANNEX V – SPECIAL AREAS
GULF OF MEXICO & CARIBBEAN SEA – Food waste en route ground to pass through a
one-inch mesh screen.
WESTERN CARIBBEAN REGION – Discharge of all garbage prohibited within 12 nautical miles
of land.
Any person who violates the above requirements is liable for civil and/or criminal penalties and
regional, state and local restrictions on garbage discharges may also apply.
REPORT ILLEGAL DISPOSAL TO THE U.S. COAST GUARD ON VHF RADIO CHANNEL 16

DANGER
Carbon monoxide (CO) can cause brain damage
or death.
Engine and generator exhaust contains odorless
and colorless carbon monoxide gas.
Carbon monoxide will be around the back of the
boat when engines or generators are running.
Move to fresh air, if you feel nausea, headache,
dizziness, or drowsiness.



REGAL MARINE AND BOATWORKS
 THE DRAWING IS CONFIDANTIAL AND IS THE SOLE PROPERTY OF REGAL MARINE
 INDUSTRIES. NO PART OF THIS DRAWING IS TO BE REPRODUCED OR TRANSMITTED IN ANY FORM OR BY ANY MEANS, ELECTRONIC OR MECHANICAL, INCLUDING PHOTOCOPYING, RECORDING, OR BY ANY INFORMATION STORAGE AND RETRIEVAL SYSTEM, WITHOUT THE WRITTEN PERMISSION OF REGAL MARINE INDUSTRIES.

 REGAL MARINE INDUSTRIES <small>ONE ALBERTA DRIVE, SUITE 100 TEL: 407.925.1490</small>		<small>ALL RIGHTS RESERVED</small>	
DATE:	10/10/17	REVISION:	-
33 SAV General Arrangements			
DATE:	10/10/17	REVISION:	-
DRAWN BY:	JPG	APPROVED BY:	Dennis R.
PAGE:		1 OF 1	
TWO: NO.:		3	



PROPRIETARY AND CONFIDENTIAL.
 THE INFORMATION CONTAINED IN THIS DRAWING IS THE SOLE PROPERTY OF REGAL MARINE
 INDUSTRIES. REPRODUCTION OR TRANSMISSION OF THIS INFORMATION WITHOUT THE WRITTEN
 PERMISSION OF REGAL MARINE INDUSTRIES IS PROHIBITED.

 REGAL MARINE INDUSTRIES <small>ORLANDO, FLORIDA 32809 TEL: (407) 591-1800</small>		<small>ALL RIGHTS RESERVED</small>	
33 SAV Staboard Profile			
DATE:	10/10/17	REVISION:	-
DRAWN BY:	JPG	APPROVED BY:	Dennis R.
PAGE:		1 OF 1	
DRAWING NO.:		4	

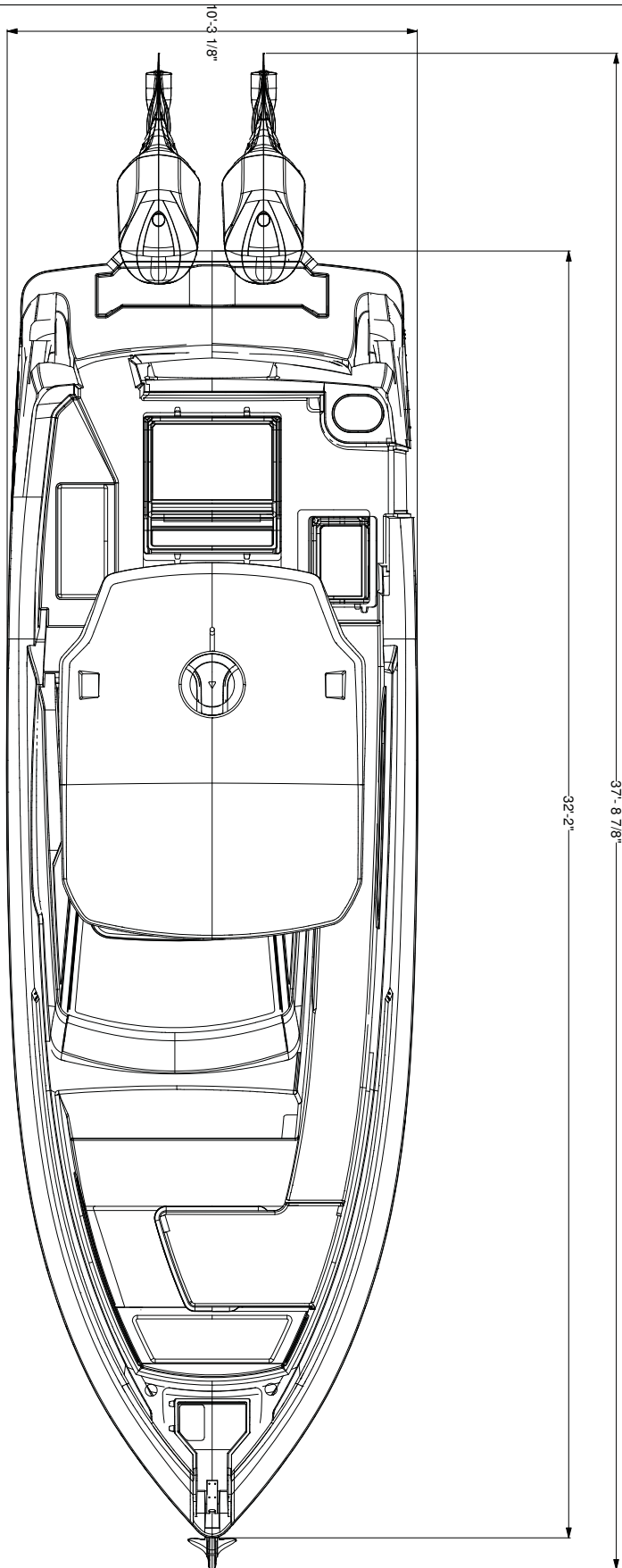

PROHIBIT AND CONFIDENTIAL. ANY REPRODUCTION OR TRANSMISSION OF THIS INFORMATION WITHOUT THE WRITTEN PERMISSION OF REGAL MARINE INDUSTRIES IS PROHIBITED.

 REGAL MARINE INDUSTRIES 2200 ALBERTA DRIVE FORT WORTH, TEXAS 76116 TEL: (817) 561-4800 ALL RIGHTS RESERVED			
33 SAV Main Dimensions			
DATE:	REVISION:	SCALE:	
10/10/17	-	1 OF 1	
DRAWN BY:	APPROVED BY:	DWG. NO.:	
JPG	Dennis R.	1	

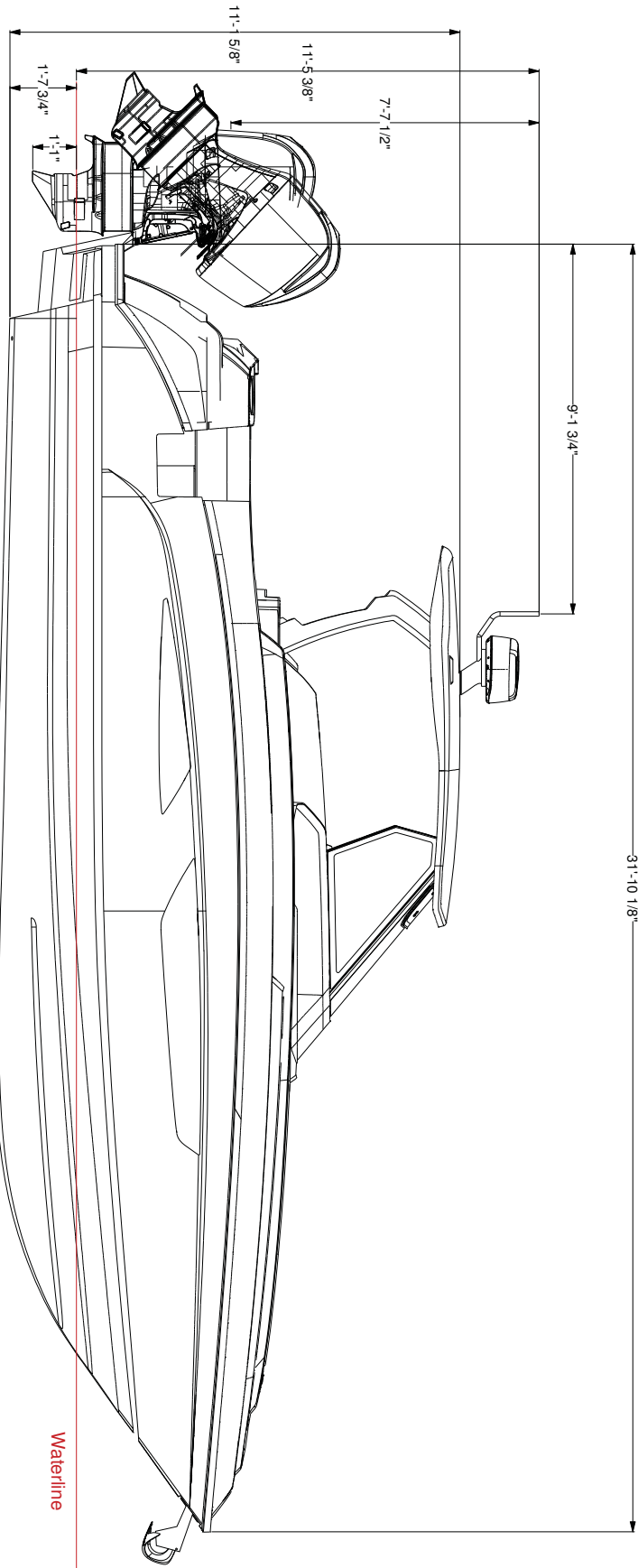

Waterline

PROPRIETARY AND CONFIDENTIAL.
 THE INFORMATION CONTAINED IN THIS DRAWING IS THE SOLE PROPERTY OF REGAL MARINE.
 REPRODUCTION OR TRANSMISSION IN ANY FORM OR BY ANY MEANS WITHOUT THE WRITTEN
 PERMISSION OF REGAL MARINE INDUSTRIES IS PROHIBITED.

 REGAL MARINE INDUSTRIES 2500 REGENT DRIVE FORT WORTH, TEXAS 76106 TEL: 817-426-5800 FAX: 817-426-5809 ALL RIGHTS RESERVED	
DRAWING TITLE: 33 SAV Main Dimensions	
DATE: 10/10/17	REVISION: -
DRAWN BY: JPG	APPROVED BY: Dennis R.
PAGE: 1 OF 1	DWG NO.: 5

15.5" W X 29.5" L
 Allowance Per Person

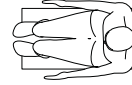

Seating Capacity: 11 Persons

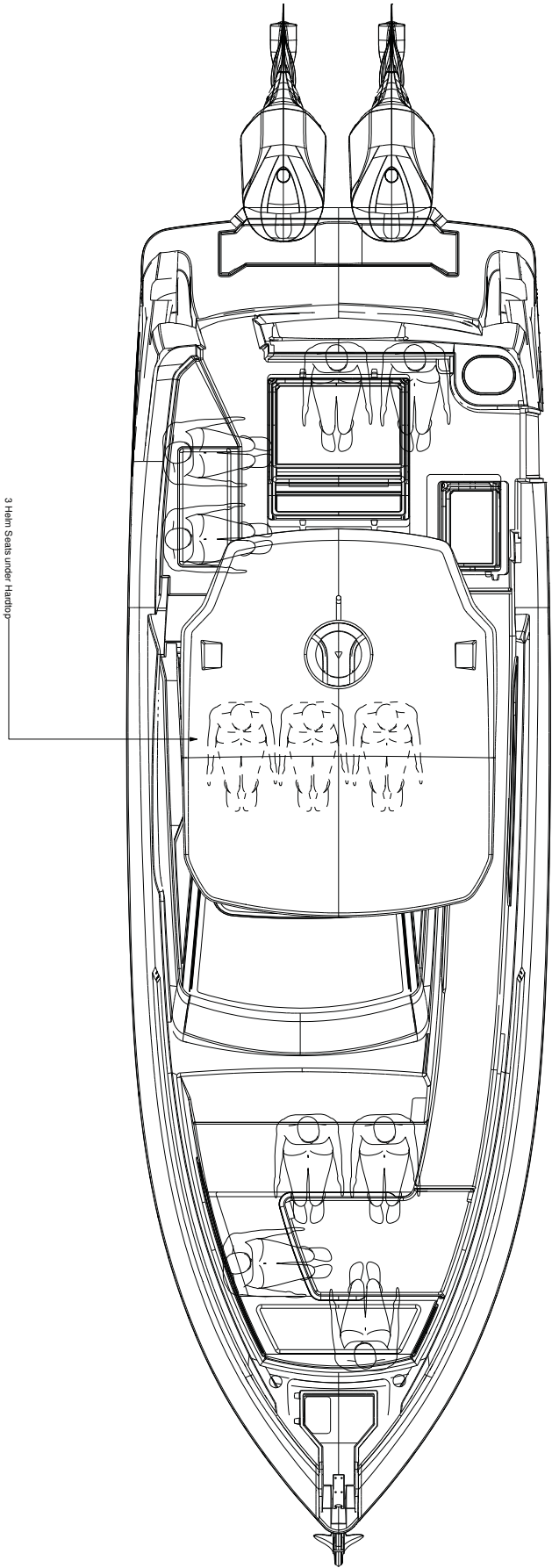

REGAL MARINE AND COMPANIES, INC.
 THIS DRAWING AND ANY INFORMATION CONTAINED THEREIN IS THE SOLE PROPERTY OF REGAL MARINE INDUSTRIES. NO PART OF THIS DRAWING IS TO BE REPRODUCED OR TRANSMITTED IN ANY FORM OR BY ANY MEANS, ELECTRONIC OR MECHANICAL, WITHOUT THE WRITTEN PERMISSION OF REGAL MARINE INDUSTRIES, INC.

 REGAL MARINE INDUSTRIES <small>ONE ALCO FICORIDA 2309 TEL: (904) 291-1800</small>		<small>ALL RIGHTS RESERVED</small>	
DRAWING TITLE	33 SAV Persons Capacity	REVISION	PAGE
DATE	10/10/17	-	1 OF 1
DRAWN BY	JPG	APPROVED BY	Dennis R.
			DWG. NO.
			2

STBD Side

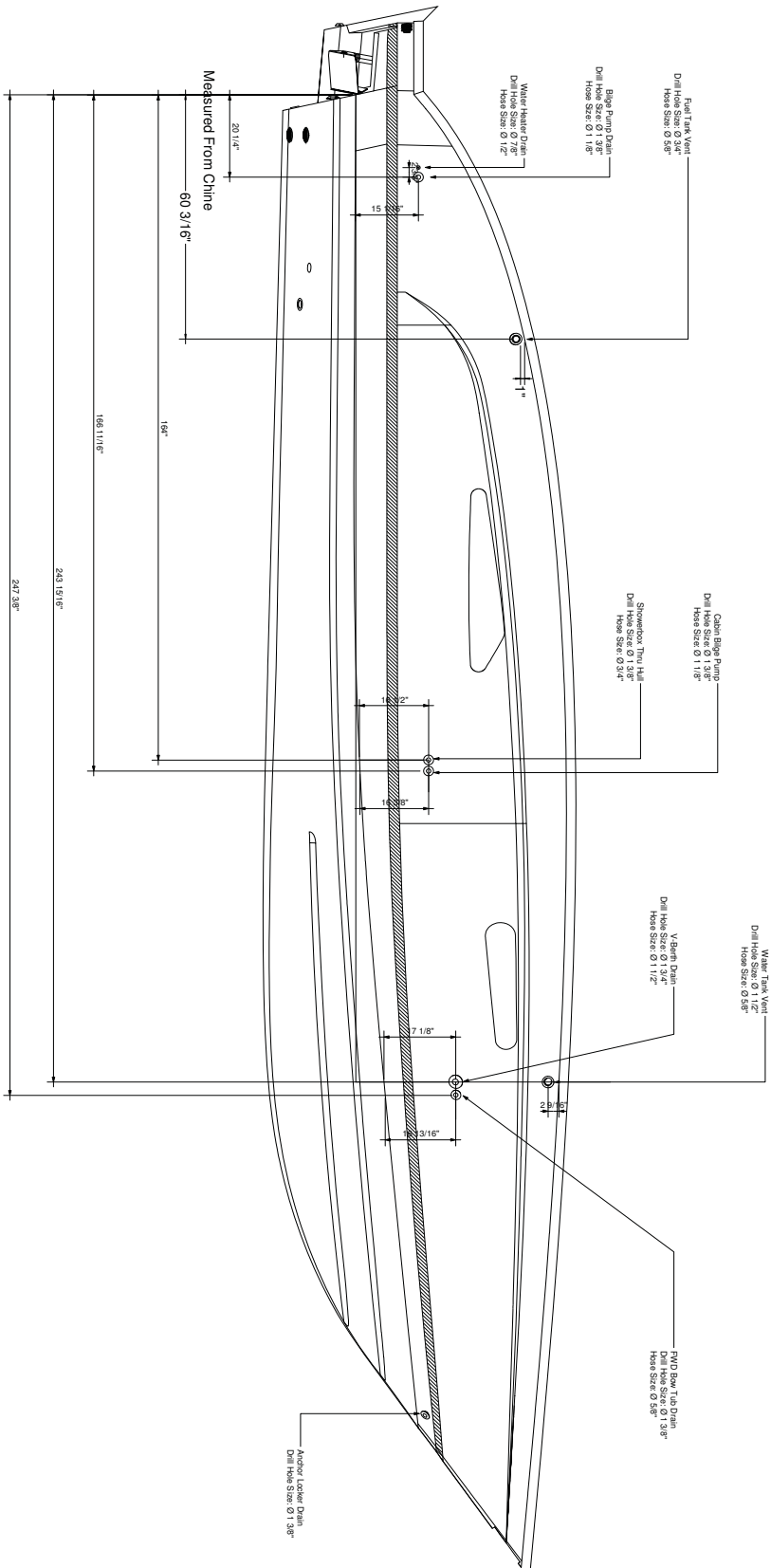

PROPRIETARY AND CONFIDENTIAL.
 THE INFORMATION CONTAINED IN THIS DRAWING IS THE SOLE PROPERTY OF REGAL MARINE.
 NO REUSE, REPRODUCTION, OR TRANSMISSION OF ANY KIND IS PERMITTED WITHOUT THE WRITTEN
 PERMISSION OF REGAL MARINE INDUSTRIES IS PROHIBITED.

 REGAL MARINE INDUSTRIES 2200 ALBERT DRIVE TEL: (407) 561-4000 FAX: (407) 561-5009 ALL RIGHTS RESERVED	
DRAWING TITLE: 33 SAV (VX) Hull Hardware	
DATE: 11/13/2017	REVISION: 0
DRAWN BY: CVL	APPROVED BY: Mike W.
SCALE: 1 OF 4	DWG NO: MWX24A

Port Side

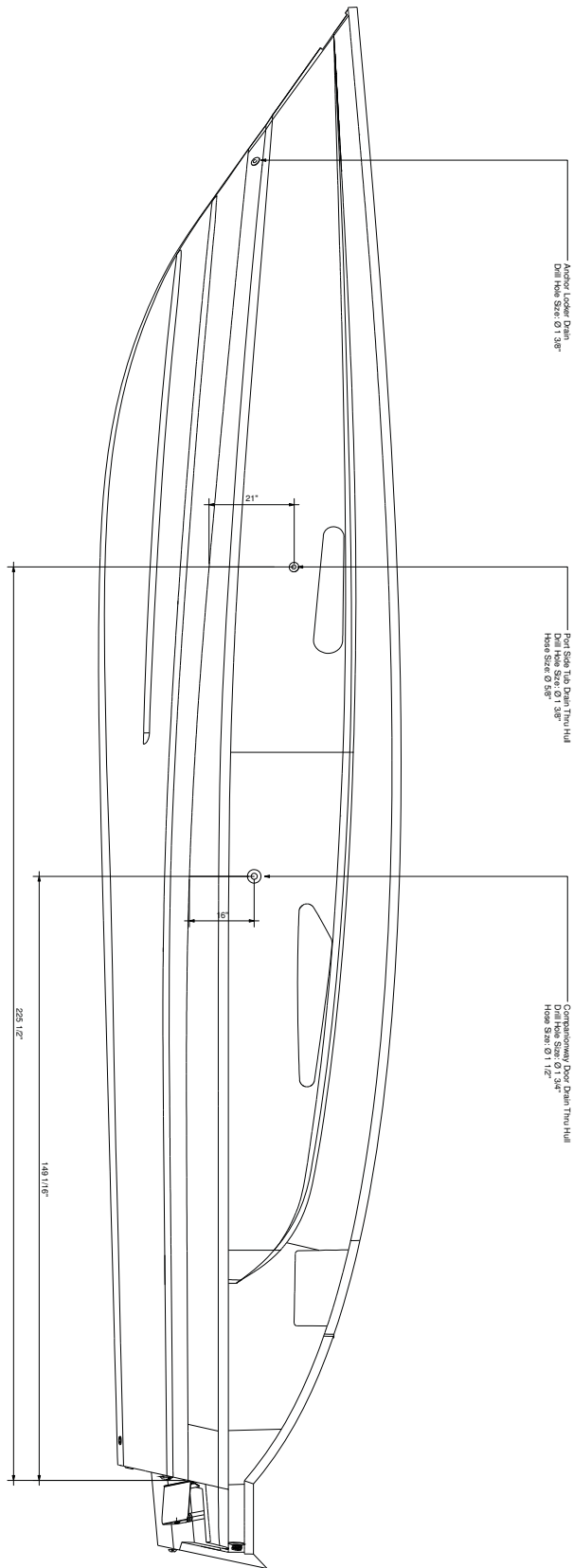

PROHIBITIVE AND CONFIDENTIAL.
NO REPRODUCTION OR TRANSMISSION IN ANY MANNER IS ALLOWED WITHOUT THE WRITTEN PERMISSION OF REGAL MARINE INDUSTRIES INCORPORATED.

 REGAL MARINE INDUSTRIES 2000 ALBERTA DRIVE FORT WORTH, TEXAS 76116 TEL: (817) 561-1800		ALL RIGHTS RESERVED	
33 SAV (VX) Hull Hardware			
DATE:	11/13/2017	REVISION:	0
DRAWN BY:	CVL	APPROVED BY:	Mike W.
PAGE:	2 OF 4	DRAWING NO: MVX24A	

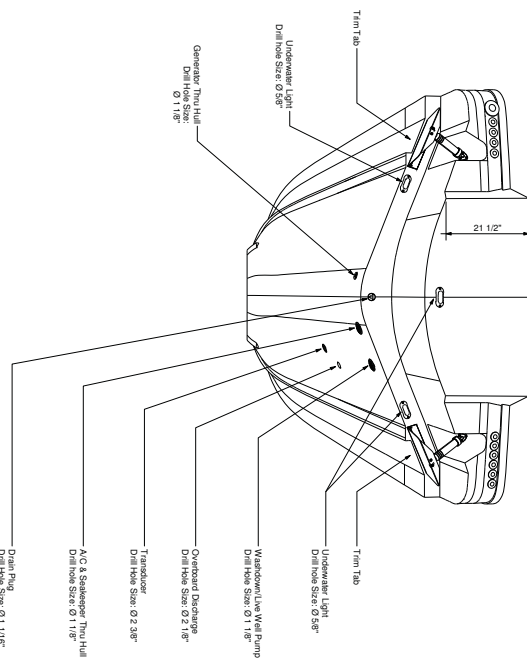

(Option)
(Option)

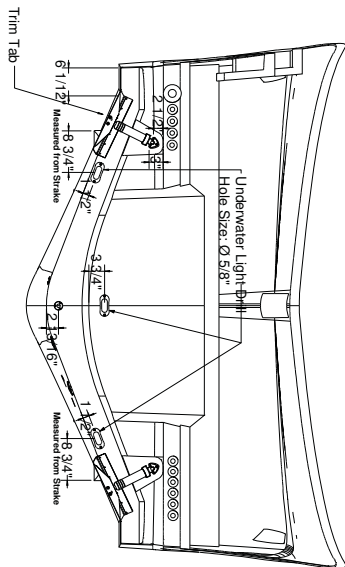
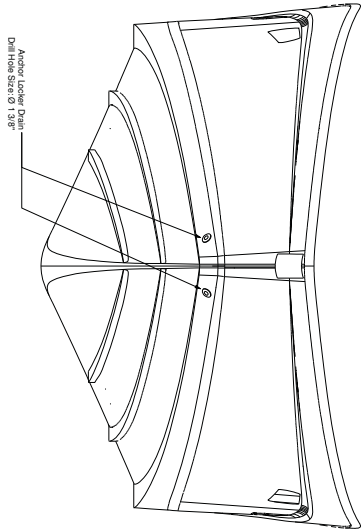
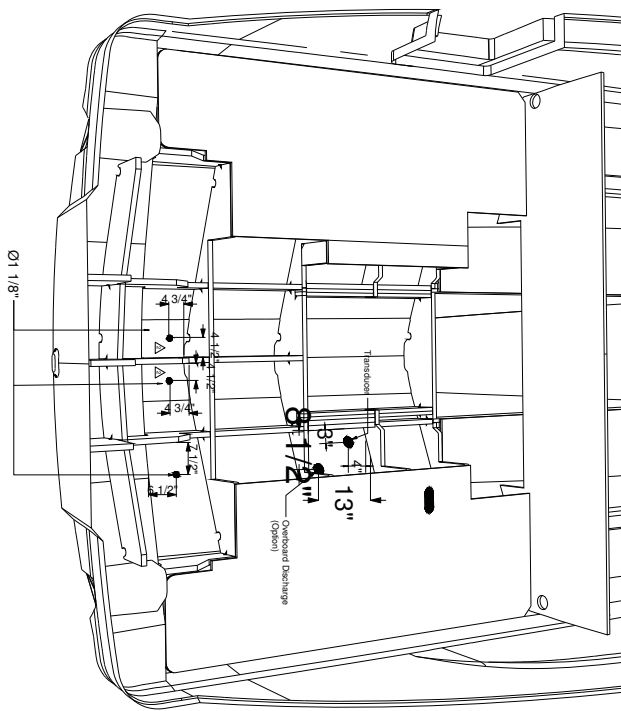

PROPRIETARY AND CONFIDENTIAL.
REGAL MARINE INDUSTRIES ASSUMES NO RESPONSIBILITY FOR ANY DAMAGE TO OR LOSS OF EQUIPMENT OR PERSONS OR PROPERTY CAUSED BY THE USE OF THIS DRAWING WITHOUT THE WRITTEN PERMISSION OF REGAL MARINE INDUSTRIES IS PROHIBITED.

 REGAL MARINE INDUSTRIES 2500 ATLANTIC AVENUE FORT WORTH, TEXAS 76149 TEL: 817-561-4300		ALL RIGHTS RESERVED	
DRAWING TITLE			
33 SAV (VX) Hull Hardware			
DATE	REVISION	PKL#	
11/13/2017	0	3 OF 4	
DRAWN BY	APPROVED BY		
CVL	Mike W.		
		DWG. NO.	MVX24A

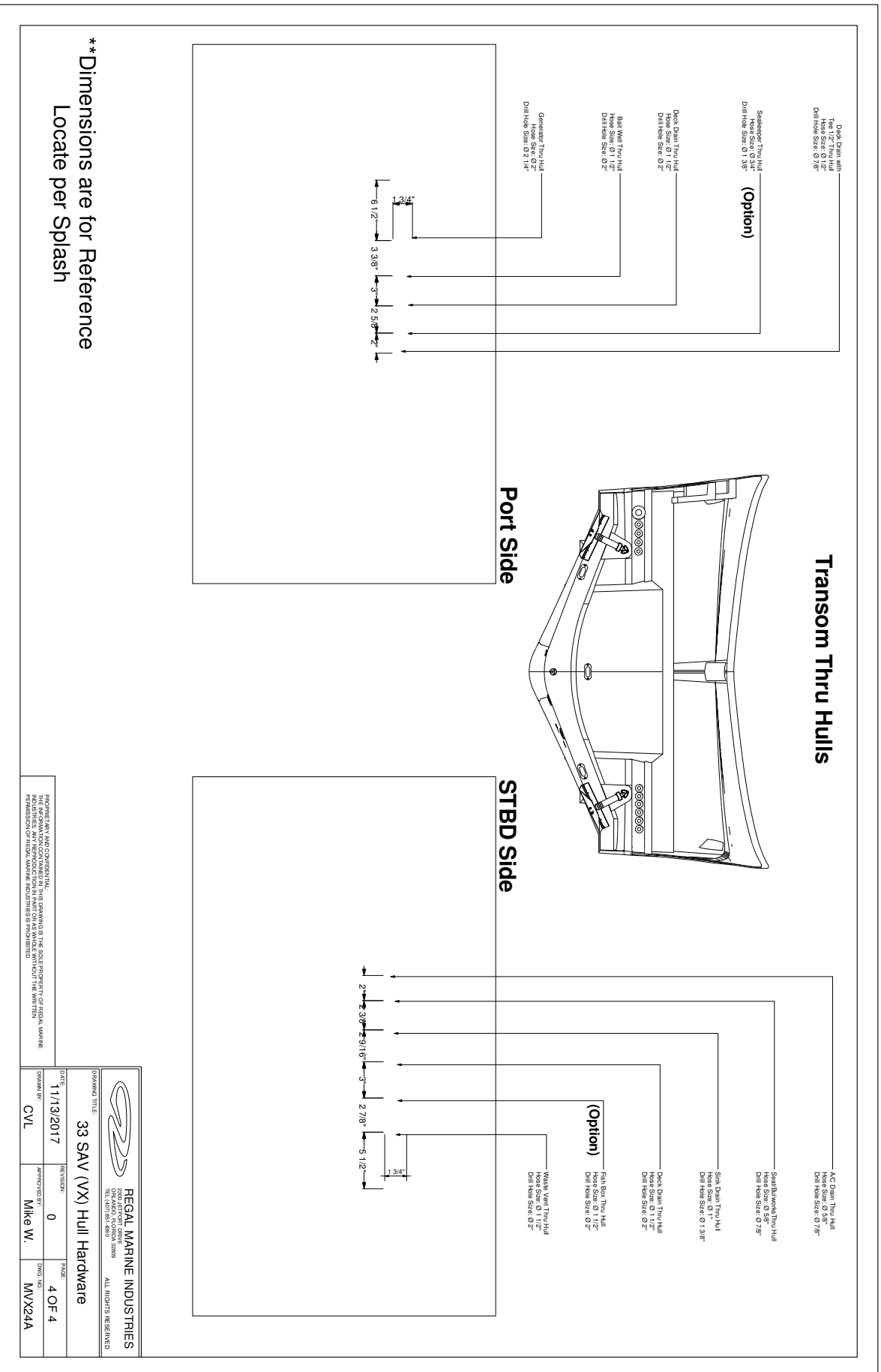

****Dimensions are for Reference
Locate per Splash**

PHONE/FAX AND CONFIDENTIAL. DRAWING IS THE PROPERTY OF REGAL MARINE INDUSTRIES. ANY REPRODUCTION IN PART OR AS A WHOLE WITHOUT THE WRITTEN PERMISSION OF REGAL MARINE INDUSTRIES IS PROHIBITED.

 REGAL MARINE INDUSTRIES 2000 ALBERTA DRIVE BOCA RATON, FL 33433 TEL: (561) 991-4800			
DRAWING TITLE: 33 SAV (VX) Hull Hardware			
DATE: 11/13/2017	REVISION: 0	PAGE: 4 OF 4	
DRAWN BY: CVL	APPROVED BY: Mike W.	DWG. NO.: MWX24A	

ALL RIGHTS RESERVED

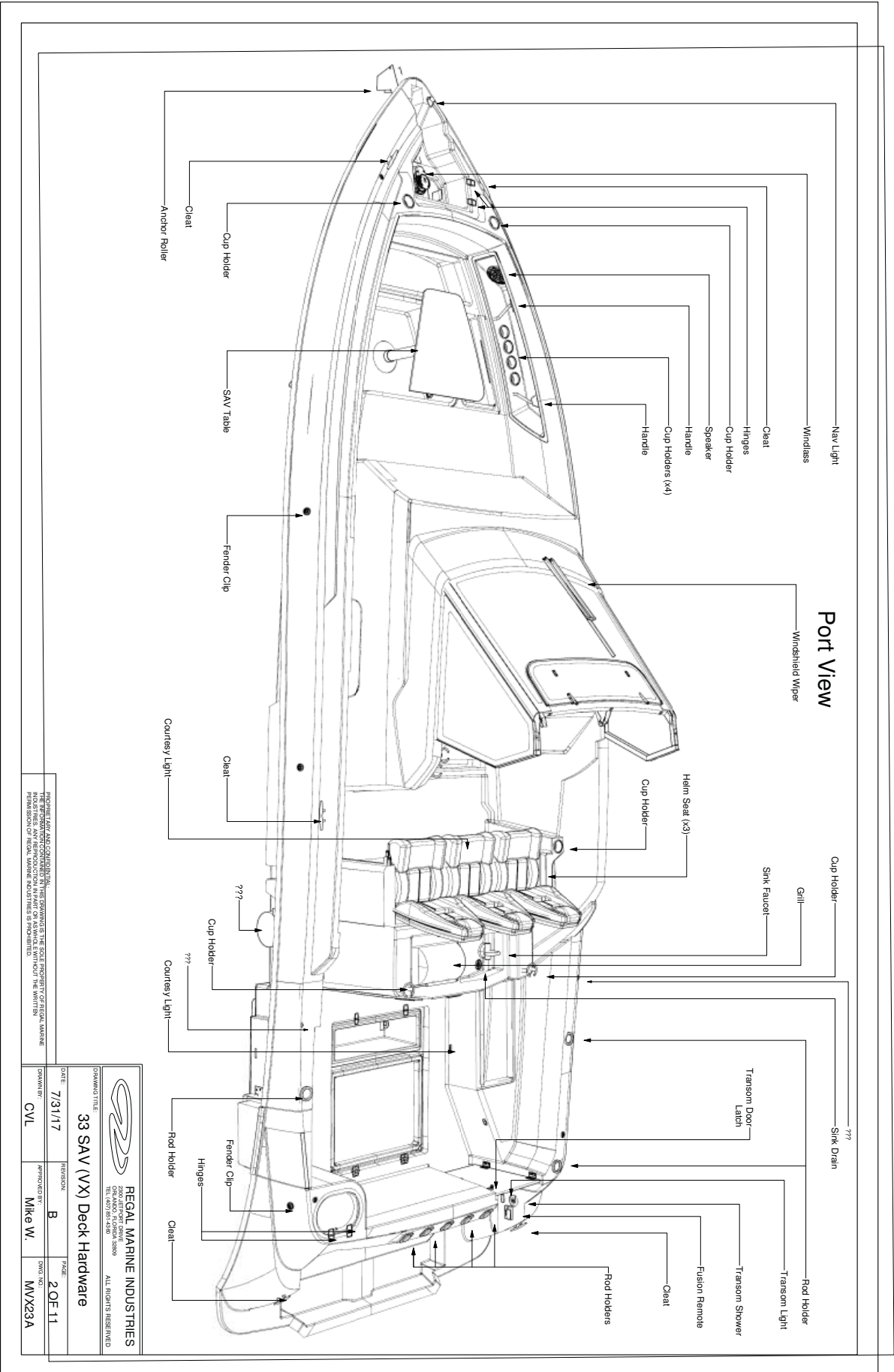

Port View

FOR THE LIFE AND CONVENIENCE OF THE BOAT, THE SOLE PROPERTY OF REGAL MARINE INDUSTRIES, ANY PERFORMANCE IN PART OR AS WHOLE WITHOUT THE WRITTEN PERMISSION OF REGAL MARINE INDUSTRIES IS VOID.

 <p>REGAL MARINE INDUSTRIES 200 ALBERTA DRIVE GAITHERSBURG, MD 20878 TEL: (410) 281-4400 ALL RIGHTS RESERVED</p>					
DATE:	7/31/17	REVISION:	B	DATE:	20E11
DRAWING TITLE:	33 SAV (VX) Deck Hardware				
DRAWN BY:	CVL	APPROVED BY:	Mike W.	DATE:	MVX23A

Hardtop Hardware

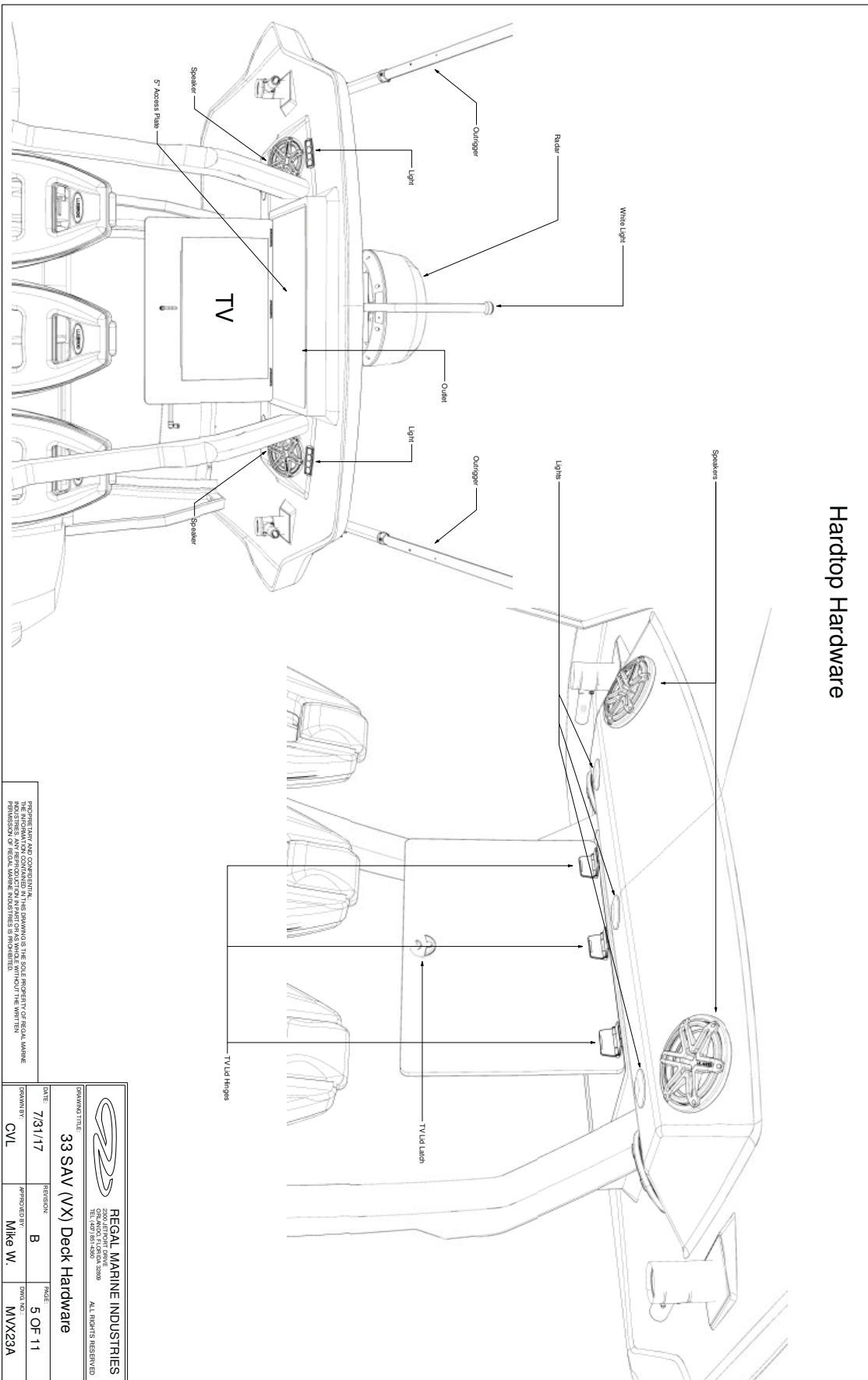

PROFITING FROM AND COMMERCIALIZING IN SOLUTIONS IS THE SOLE PROPERTY OF REGAL MARINE INDUSTRIES. ANY REPRODUCTION IN ANY FORM OR MANNER WITHOUT THE WRITTEN PERMISSION OF REGAL MARINE INDUSTRIES IS PROHIBITED.



 REGAL MARINE INDUSTRIES 2000 LESTER DRIVE FORT WORTH, TEXAS 76104 TEL: (817) 561-4400 FAX: (817) 561-4401			
DRAWING TITLE: 33 SAV (VX) Deck Hardware			
DATE:	REVISION:	SCALE:	
7/31/17	B	5 OF 11	
DRAWN BY:	APPROVED BY:	WORK NO.:	
CVL	Mike W.	MYX29A	

Table Top Holder

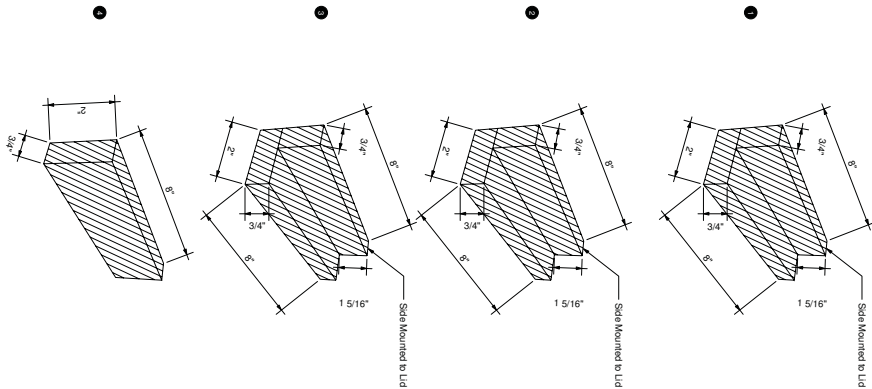

PHOTOMETRY AND COMPONENTS, THE SPACING, IS THE SOLE PROPERTY OF REGAL MARINE INDUSTRIES. ANY REPRODUCTION IN PART OR AS WHOLE WITHOUT THE WRITTEN PERMISSION OF REGAL MARINE INDUSTRIES IS PROHIBITED.

 REGAL MARINE INDUSTRIES 22001 TERRY AVENUE TEL: (407) 561-1500 ALL RIGHTS RESERVED			
DATE	REVISION	PKG#	
7/31/17	B	11 OF 11	
DESIGNER	APPROVED BY	SIZE	NO.
CVL	MIKE W.	MWX23A	
DRAWING TITLE: 33 SAV (VX) Deck Hardware			

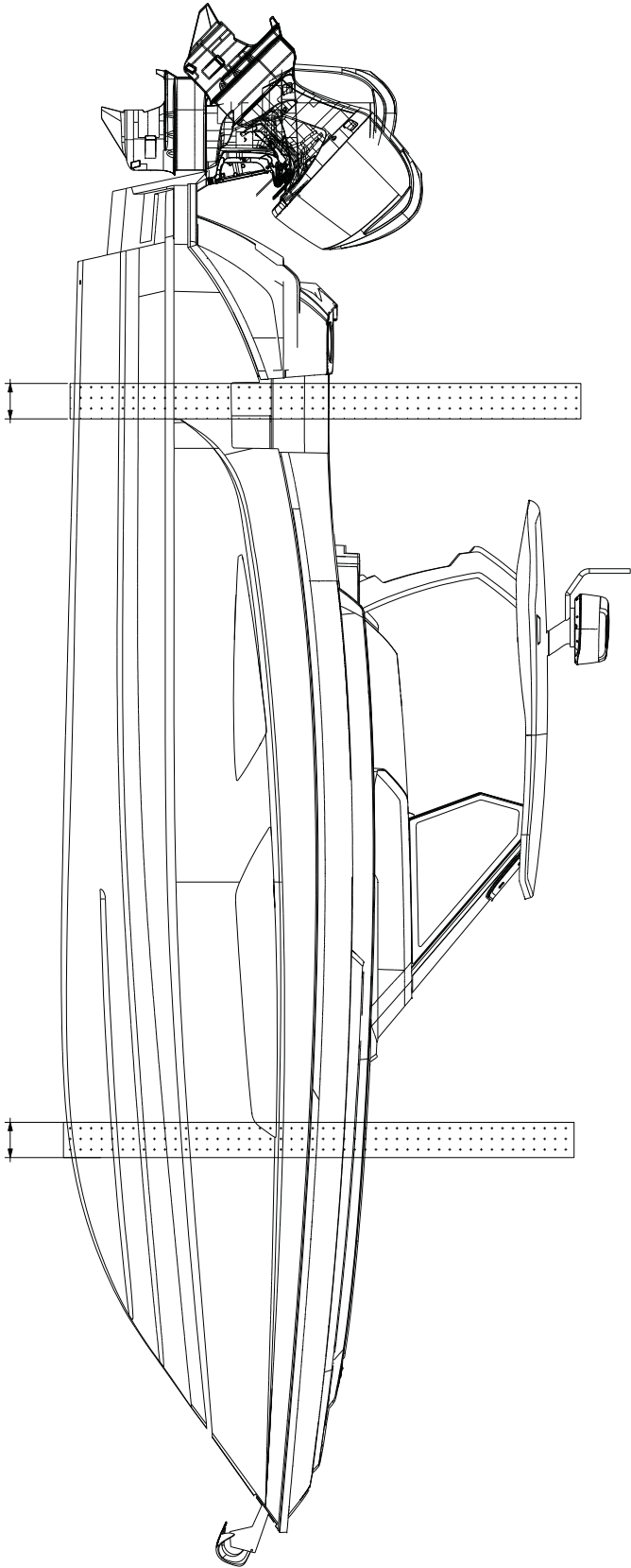

10" Slings

10" Slings

PROFESSIONAL AND CONFIDENTIAL. THIS DRAWING IS THE SOLE PROPERTY OF REGAL MARINE INDUSTRIES. ANY REPRODUCTION IN PART OR AS WHOLE WITHOUT THE WRITTEN PERMISSION OF REGAL MARINE INDUSTRIES IS PROHIBITED.

 REGAL MARINE INDUSTRIES 2200 ALBERT AVENUE TEL: (877) 561-4300			
DRAWING TITLE: 33 SAV Main Dimensions			
DATE:	REVISION:	SCALE:	
10/10/17	-	1 OF 1	
DRAWN BY:	APPROVED BY:	SIZE:	
JPG	Dennis R.	6	

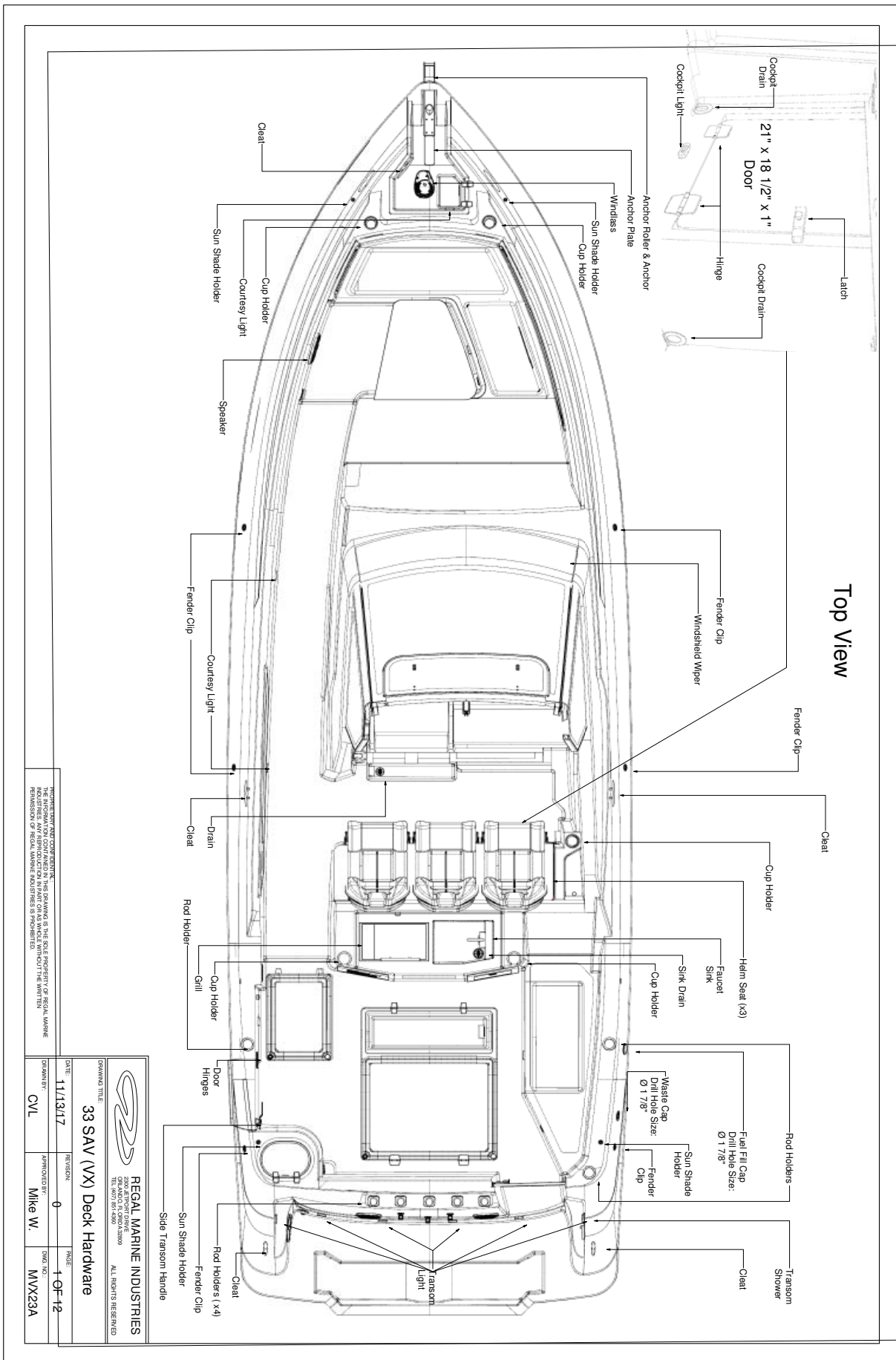

Top View

THIS DRAWING IS THE PROPERTY OF REGAL MARINE INDUSTRIES. NO PART OF THIS DRAWING IS TO BE REPRODUCED OR TRANSMITTED IN ANY FORM OR BY ANY MEANS, ELECTRONIC OR MECHANICAL, INCLUDING PHOTOCOPYING, RECORDING, OR BY ANY INFORMATION STORAGE AND RETRIEVAL SYSTEM, WITHOUT THE WRITTEN PERMISSION OF REGAL MARINE INDUSTRIES. © 2009

 <p>REGAL MARINE INDUSTRIES 2500 AIRPORT DRIVE FORT WORTH, TEXAS 76150 TEL: 817-561-5800 FAX: 817-561-5809 ALL RIGHTS RESERVED</p>					
DATE:	11/13/17	REV. NO.:	0	SCALE:	1 OF 12
DRAWN BY:	CVL	APPROVED BY:	Mike W.	DWG. NO.:	MWX23A
<p>DRAWING TITLE: 33 SAV (VX) Deck Hardware</p>					

Port Side

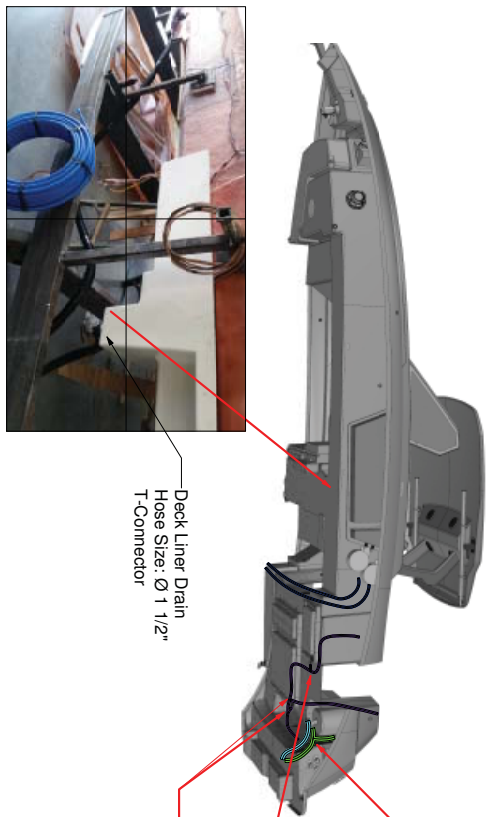

Deck Liner Drain
Hose Size: Ø 1 1/2\"/>

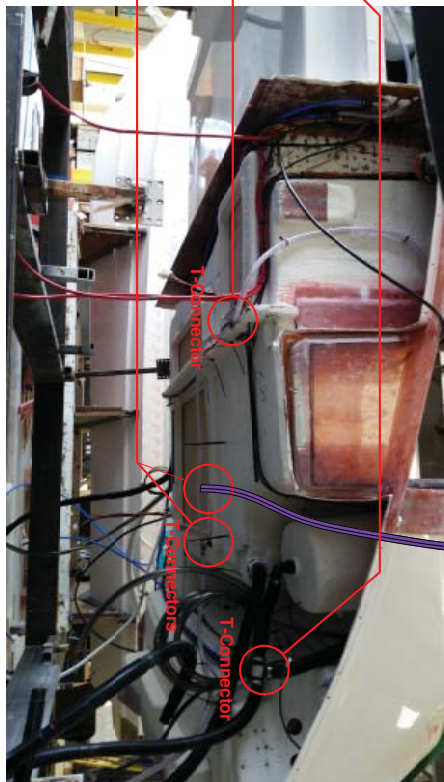

Sun Shade Drain Hose

T-Connector

T-Connector

T-Connector

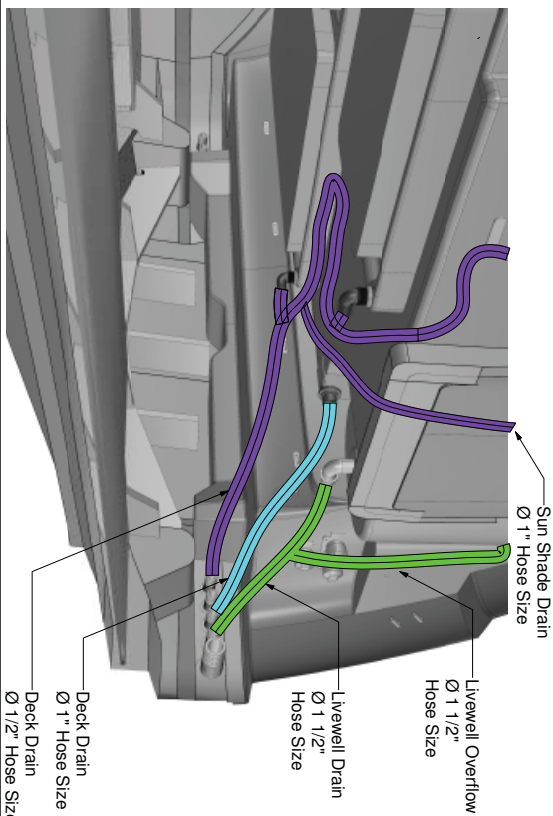

Sun Shade Drain
Ø 1\"/>

Livewell Overflow
Ø 1 1/2\"/>

Livewell Drain
Ø 1 1/2\"/>

Deck Drain
Ø 1\"/>

Deck Drain
Ø 1/2\"/>



REGAL MARINE INDUSTRIES
33 SAV (VX) Cockpit Hose Routings

 REGAL MARINE INDUSTRIES <small>ONE ALCOCK ROAD, FLORENCE, SC 29506 TEL: (803) 681-1800</small>		<small>ALL RIGHTS RESERVED.</small>	
DATE:	11/14/17	REVISION:	0
DESIGNED BY:	CVL	APPROVED BY:	Mike W.
DRAWN BY:		DWG. NO.:	MWX25N
<small>REGAL MARINE INDUSTRIES ASSUMES NO LIABILITY FOR THE INFORMATION CONTAINED IN THIS DRAWING IS THE SOLE PROPERTY OF REGAL MARINE INDUSTRIES. THE INFORMATION CONTAINED HEREIN IS PROVIDED FOR INFORMATIONAL PURPOSES ONLY. REGAL MARINE INDUSTRIES IS NOT RESPONSIBLE FOR THE WRITTEN PERMISSION OF REGAL MARINE INDUSTRIES IS PROVIDED.</small>		<small>TRADE:</small> 1 OF 8	

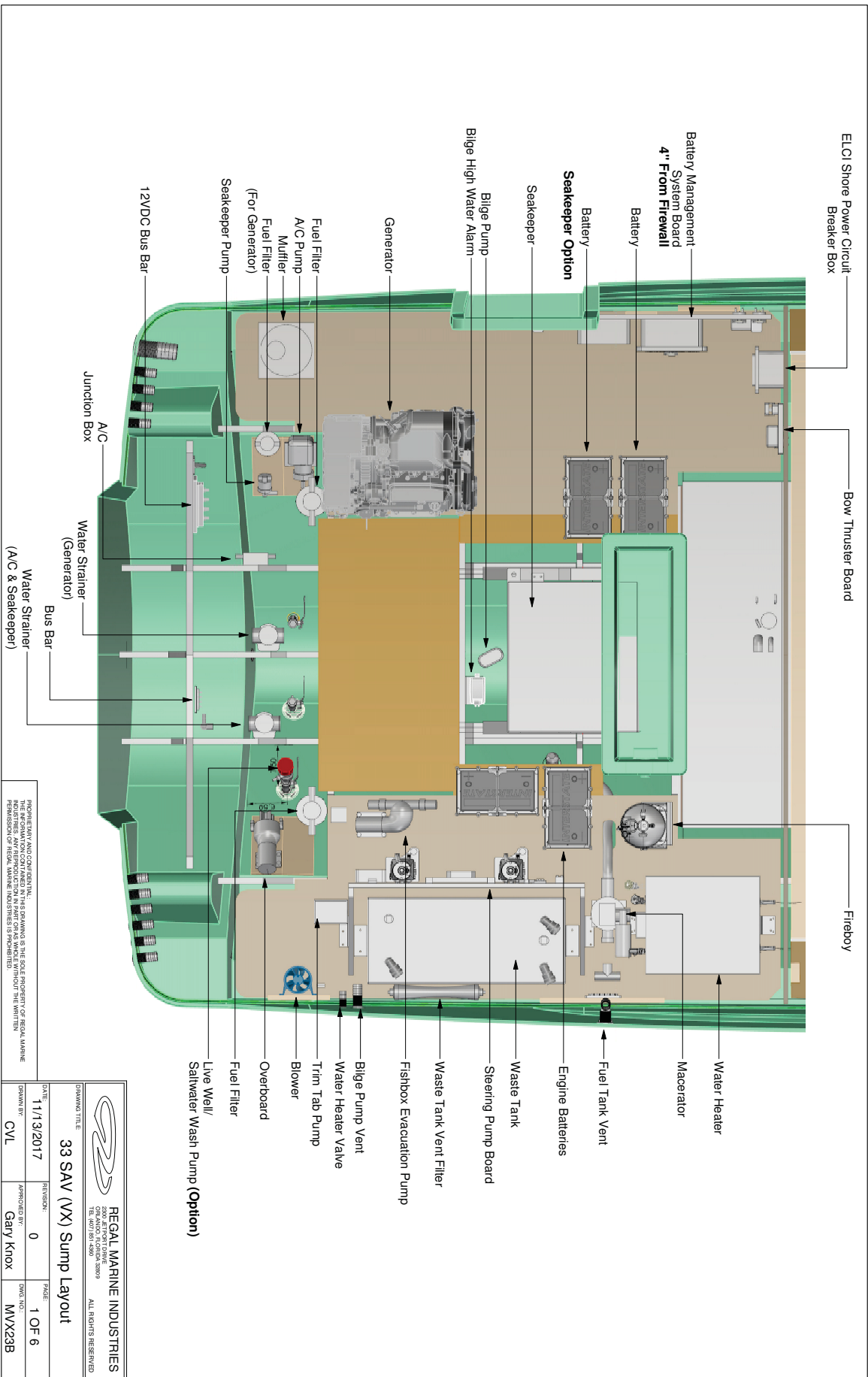

REGAL MARINE AND CONFIDENTIAL:
 THE INFORMATION CONTAINED IN THIS DRAWING IS THE SOLE PROPERTY OF REGAL MARINE
 INDUSTRIES. ANY REUSE OR REPRODUCTION OF THIS INFORMATION WITHOUT THE EXPRESS
 PERMISSION OF REGAL MARINE INDUSTRIES IS PROHIBITED.

 REGAL MARINE INDUSTRIES 2000 ALBERTA DRIVE FORT WORTH, TEXAS 76104 TEL: (817) 861-1400		ALL RIGHTS RESERVED	
DATE:	11/13/2017	REVISION:	0
DRAWN BY:	CVL	APPROVED BY:	Gary Knox
DRAWING TITLE: 33 SAV (VX) Sump Layout		PAGE:	1 OF 6
		DWG. NO.:	MVX23B

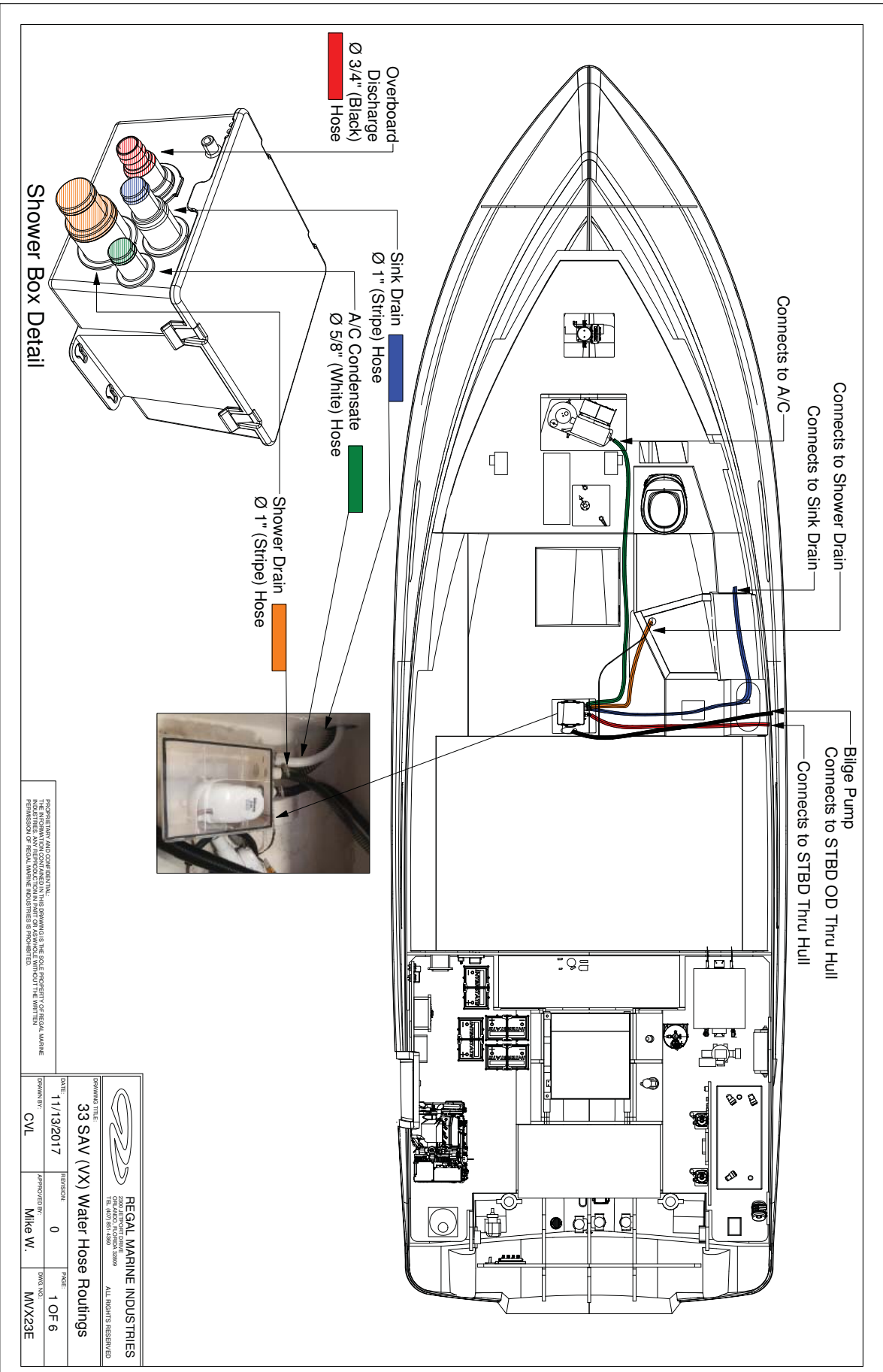

PROPRIETARY AND CONFIDENTIAL.
THE INFORMATION CONTAINED IN THIS DRAWING IS THE SOLE PROPERTY OF REGAL MARINE INDUSTRIES. NO PART OF THIS DRAWING MAY BE REPRODUCED OR TRANSMITTED IN ANY FORM OR BY ANY MEANS, ELECTRONIC OR MECHANICAL, WITHOUT THE WRITTEN PERMISSION OF REGAL MARINE INDUSTRIES. © 2017 REGAL MARINE INDUSTRIES

 REGAL MARINE INDUSTRIES CONSULTING ENGINEERS 10000 W. 10th Avenue, Suite 100 Golden, Colorado 80401		ALL RIGHTS RESERVED	
33 SAV (VX) Water Hose Routings			
DATE:	11/13/2017	REVISION:	0
DRAWN BY:	CVL	APPROVED BY:	Mike W.
PAGE:		1 OF 6	
DRAWN TO:		MVX23E	

Waste Hose Routing
All Waste Hose Sizes: Ø 1 1/2"

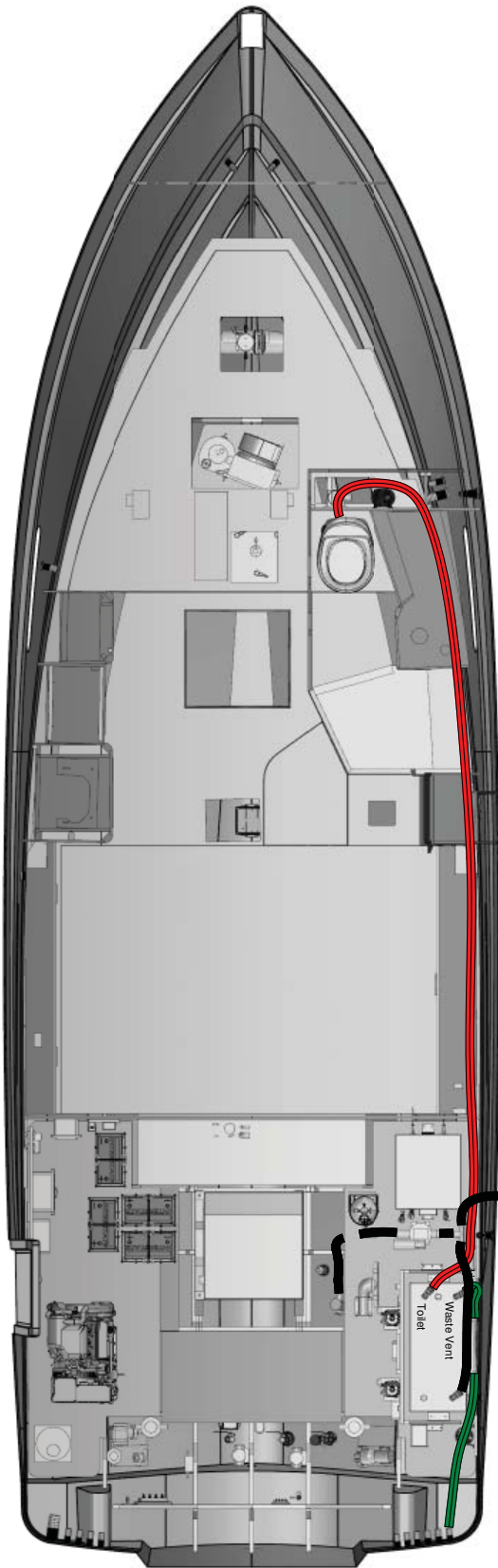

PROPRIETARY AND CONFIDENTIAL.
 THE INFORMATION CONTAINED IN THIS DRAWING IS THE SOLE PROPERTY OF REGAL MARINE INDUSTRIES. ANY REPRODUCTION OR TRANSMISSION OF THIS INFORMATION WITHOUT THE WRITTEN PERMISSION OF REGAL MARINE INDUSTRIES IS PROHIBITED.

 REGAL MARINE INDUSTRIES 20000 W. COUNTY ROAD 100 GREEN BROOK, TEXAS 75042 TEL: 972.380.3000		ALL RIGHTS RESERVED	
		DATE	REVISION
11/13/2017	0	33 SAV (VX) Waste Hose Routings	1 OF 3
DRAWN BY: CVL	APPROVED BY: Mike W.	DWG. NO.: MVX23D	

Waste Hose Routing
All Waste Hose Sizes: Ø 1 1/2"

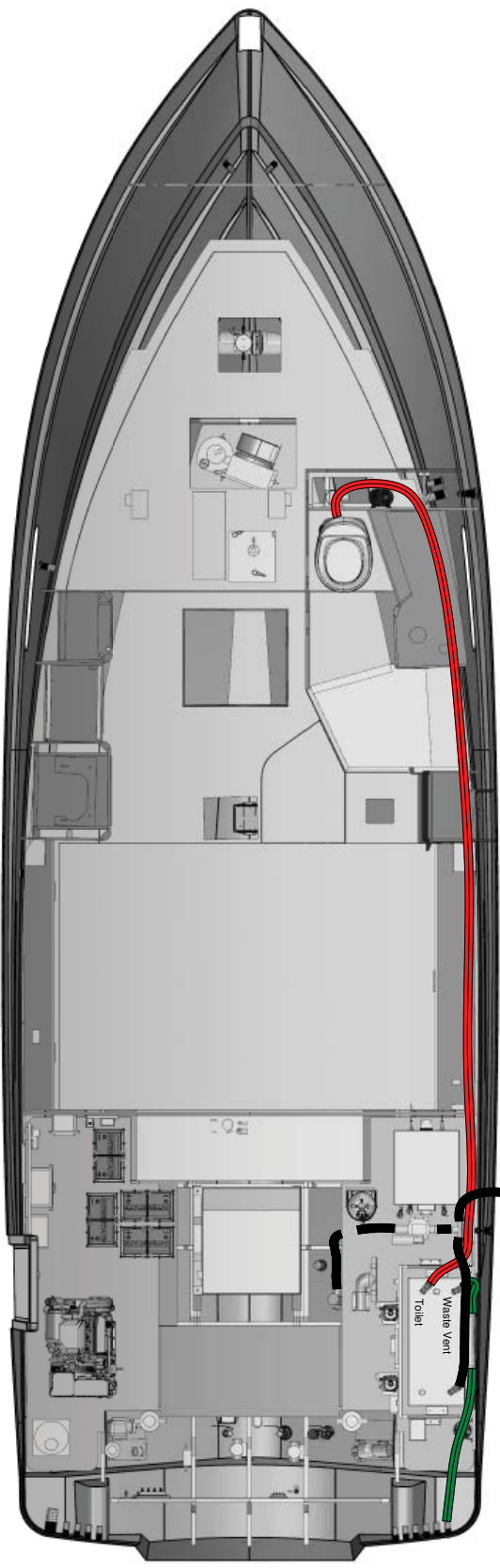

Connects to Waste Cap on Deck

REGAL MARINE INDUSTRIES
 THE INFORMATION CONTAINED IN THIS DRAWING IS THE SOLE PROPERTY OF REGAL MARINE INDUSTRIES. NO PART OF THIS DRAWING IS TO BE REPRODUCED OR TRANSMITTED IN ANY FORM OR BY ANY MEANS, ELECTRONIC OR MECHANICAL, WITHOUT THE WRITTEN PERMISSION OF REGAL MARINE INDUSTRIES. © 2017

 REGAL MARINE INDUSTRIES ONE ALAMO FLORENZA, 2889 TEL: (979) 531-1500		ALL RIGHTS RESERVED	
DRAWING TITLE: 33 SAV (VX) Waste Hose Routings	REVISION: 0	PAGE: 1 OF 3	
DATE: 11/13/2017	APPROVED BY: Mike W.	DWG. NO.: MWX23D	
DRAWN BY: CVL			

BILL OF MATERIALS			BILL OF MATERIALS			BILL OF MATERIALS			BILL OF MATERIALS		
ITEM QTY.	DESCRIPTION	PART NUMBER	ITEM QTY.	DESCRIPTION	PART NUMBER	ITEM QTY.	DESCRIPTION	PART NUMBER	ITEM QTY.	DESCRIPTION	PART NUMBER
1	Bow FWD Backrest	UVX06A	12	STBD AFT Cushion	UVX15B	-	-	-	-	-	-
2	Bow STBD Coaming Panel	UVX06B	13	STBD Middle Cushion	UVX15C	-	-	-	-	-	-
3	Bow Aft Backrest	UVX06C	14	Cockpit AFT Backrest	UVX15D	-	-	-	-	-	-
4	Bow Center Cushion	UVX06D	15	Cockpit AFT Cushion	UVX15E	-	-	-	-	-	-
5	Bow STBD Cushion	UVX06E	16	STBD FWD Cushion	UVX15F	-	-	-	-	-	-
6	Bow Aft Cushion	UVX06F	17	-	-	-	-	-	-	-	-
7	Bow Filler Cushion	UVX06G	18	-	-	-	-	-	-	-	-
8	Bow Armrest	UVX06H	19	Helm Chair	UVX15A	-	-	-	-	-	-
9	Port Coaming	UVX17A	20	Dash Visor	UVX15C	-	-	-	-	-	-
10	STBD Cockpit FWD Backrest	UVX15A	-	-	-	-	-	-	-	-	-
11	Cockpit AFT Coaming	UVX17B	-	-	-	-	-	-	-	-	-

Deck View

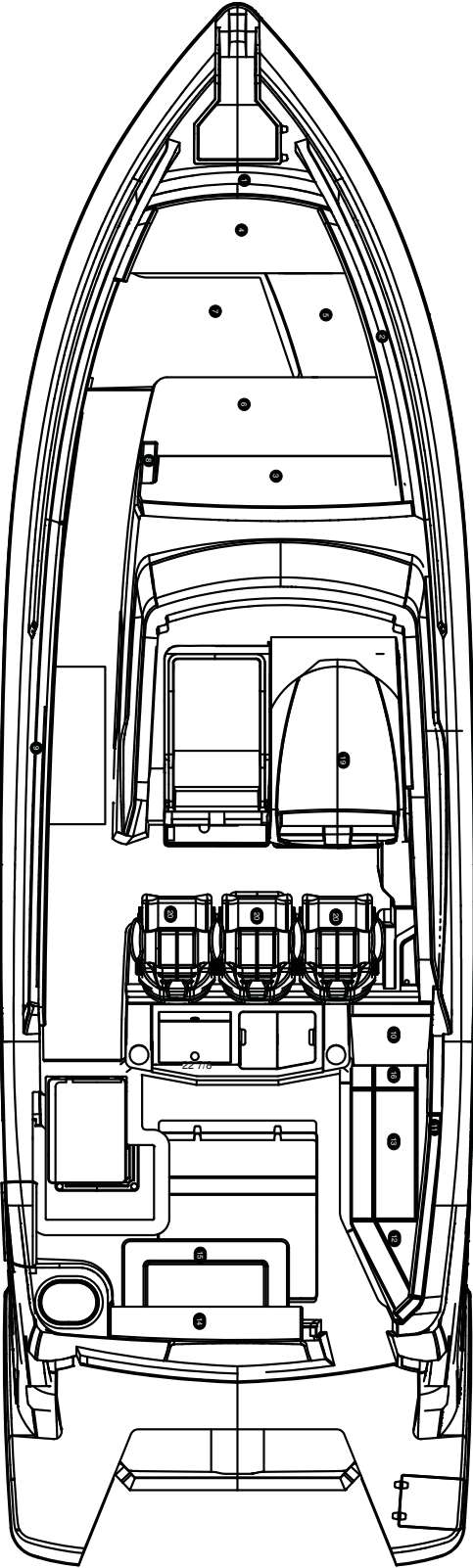

REGAL MARINE INDUSTRIES
 33 SAV (VX) Upholstery Identifier
 REGAL MARINE INDUSTRIES IS PROVIDING THIS INFORMATION AS A SERVICE TO OUR CUSTOMERS. REGAL MARINE INDUSTRIES AND COMPANIES, THEIR AFFILIATES, AGENTS, AND CONTRACTORS ASSUME NO LIABILITY FOR THE ACCURACY, COMPLETENESS, OR TIMELINESS OF THIS INFORMATION. REGAL MARINE INDUSTRIES IS PROVIDING THIS INFORMATION AS A SERVICE TO OUR CUSTOMERS.

 REGAL MARINE INDUSTRIES 2500 ALBERTA DRIVE FORT WORTH, TEXAS 76149 TEL: 817-561-4800		ALL RIGHTS RESERVED	
DATE:	11/22/17	REVISED:	0
DRAWN BY:	CWL	APPROVED BY:	Ozzie S.
33 SAV (VX) Upholstery Identifier		SCALE:	1 OF 2
		SYM. NO.:	UVX25X

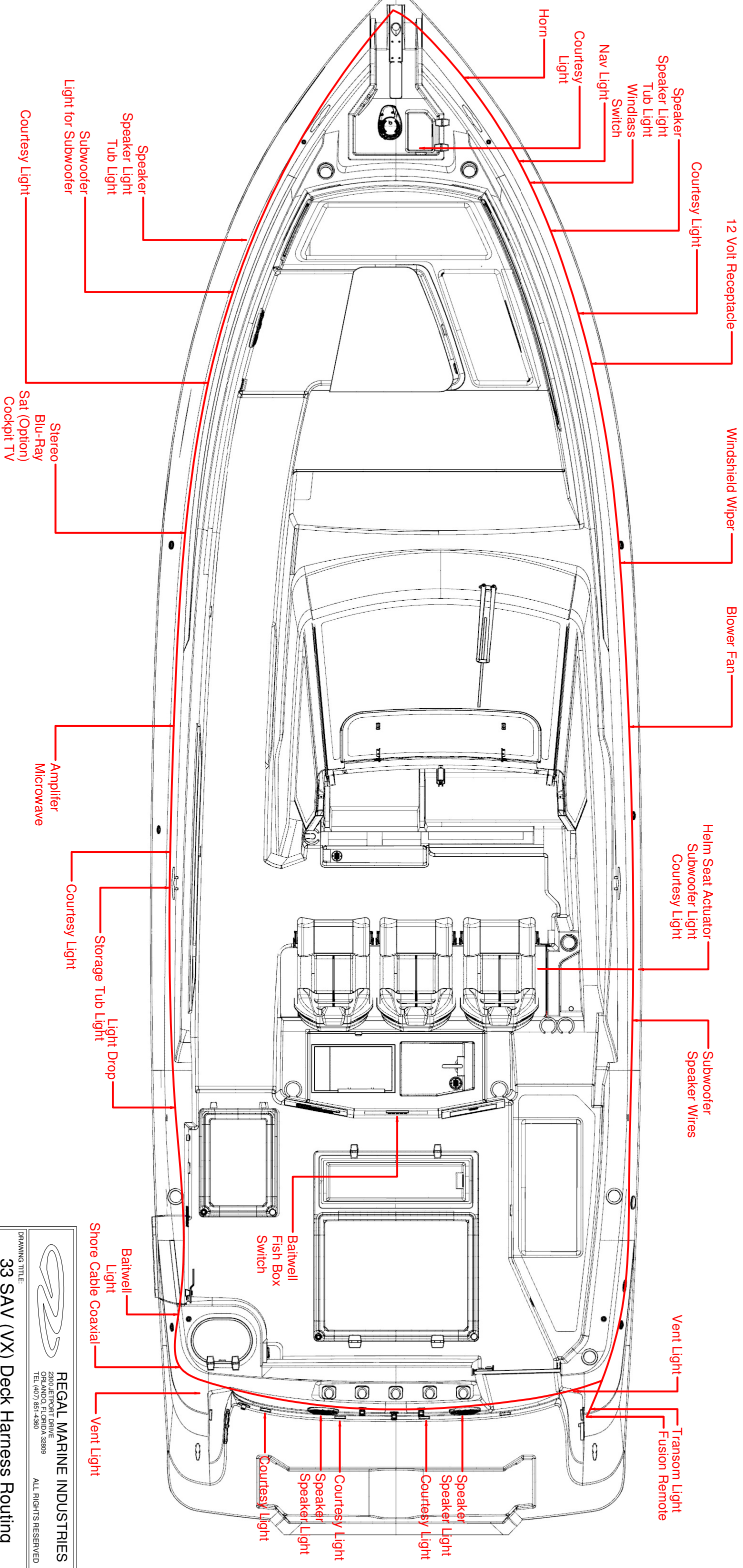

PROPRIETARY AND CONFIDENTIAL.
 THE INFORMATION CONTAINED IN THIS DRAWING IS THE SOLE PROPERTY OF REGAL MARINE INDUSTRIES. ANY REPRODUCTION IN PART OR AS WHOLE WITHOUT THE WRITTEN PERMISSION OF REGAL MARINE INDUSTRIES IS PROHIBITED.

 <p>REGAL MARINE INDUSTRIES 2300 LETPORT DRIVE ORLANDO, FLORIDA 32809 TEL. (407) 851-4380</p>		<p>ALL RIGHTS RESERVED</p>	
<p>DRAWING TITLE: 33 SAV (VX) Deck Harness Routing</p>			
DATE:	3/13/2018	REVISION:	0
DRAWN BY:	CVL	APPROVED BY:	Mark J.
PAGE:	1 OF 1	DWG. NO.:	UVX14A

Bow Thruster Cable

Connects to Bow Thruster Controller on Dash 

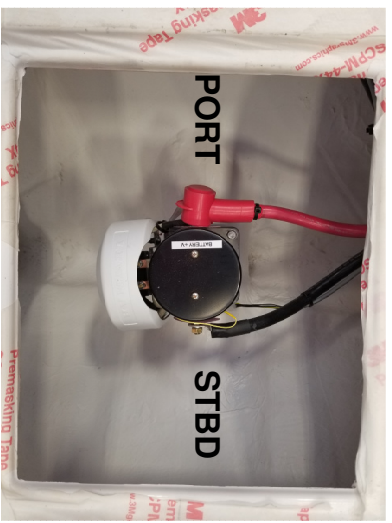
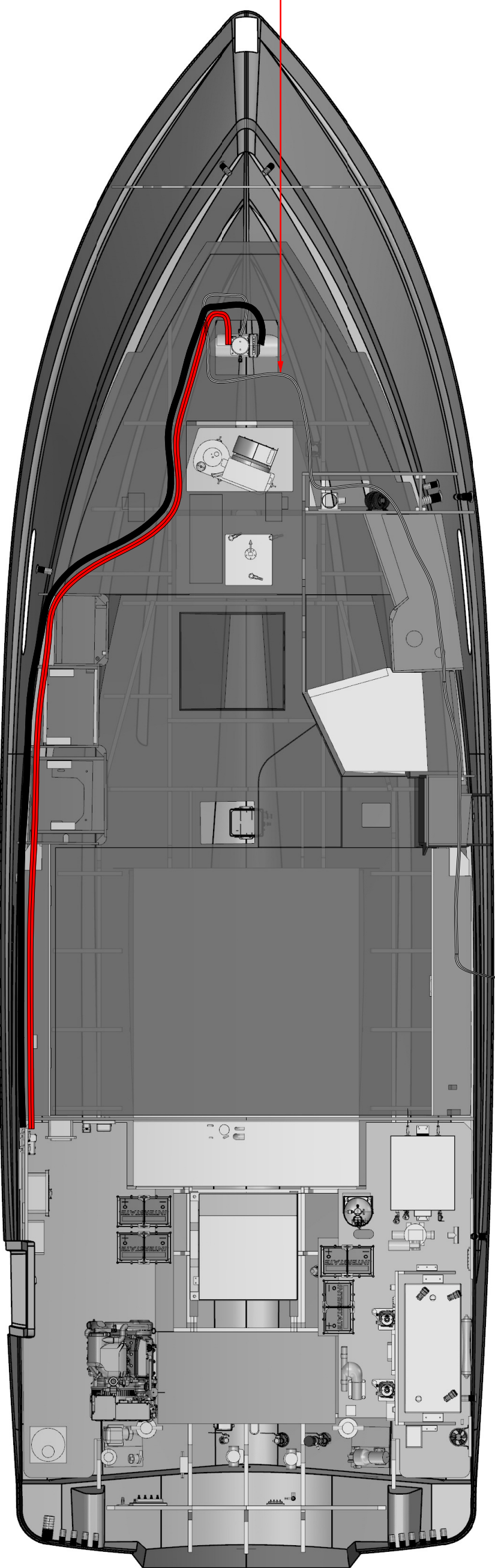

Wire runs along Port Side of Hull



Gray Wire runs Along STBD Side of Hull

REV	REVISION DESCRIPTION	VAM	MU	10/1/0/17
B	Edited Gray Wire Routing to Dash Removed Page 2	DR. BY	APP. BY	REV. DATE

REGAL MARINE INDUSTRIES
 2300 JETPORT DRIVE
 ORLANDO, FLORIDA 32809
 TEL (407) 851-4360
 ALL RIGHTS RESERVED

DRAWING TITLE:
33 SAV (VX) Bow Thruster Cable Routing

DATE:	6/26/2017	REVISION:	B	PAGE:	1 OF 1
DRAWN BY:	CVL	APPROVED BY:	Mark J.	DWG. NO.:	EVX22G

REFERENCE ONLY

PROPRIETARY AND CONFIDENTIAL.
 THE INFORMATION CONTAINED IN THIS DRAWING IS THE SOLE PROPERTY OF REGAL MARINE INDUSTRIES. ANY REPRODUCTION IN PART OR AS WHOLE WITHOUT THE WRITTEN PERMISSION OF REGAL MARINE INDUSTRIES IS PROHIBITED.



ProLariner

ProNautic 12.40P

Power Factor Corrector & Global AC Input

Pro

STATUS: **OK**

AC Input: 230V 50Hz

AC Output: 230V 50Hz

Power: 12000W

Current: 50A

Temperature: 45°C

Efficiency: 98%

Power Factor: 0.99

Warning: HIGH VOLTAGE / ATTENTION - HAUTE TENSION

Warning: LOW VOLTAGE / ATTENTION - BASSSE TENSION

Parameter	Value	Unit
AC Input Voltage	230	V
AC Input Current	50	A
AC Input Power	12000	W
AC Output Voltage	230	V
AC Output Current	50	A
AC Output Power	12000	W
Temperature	45	°C
Efficiency	98	%
Power Factor	0.99	

Panel Size: 9 7/8" x 10" x 3/8"

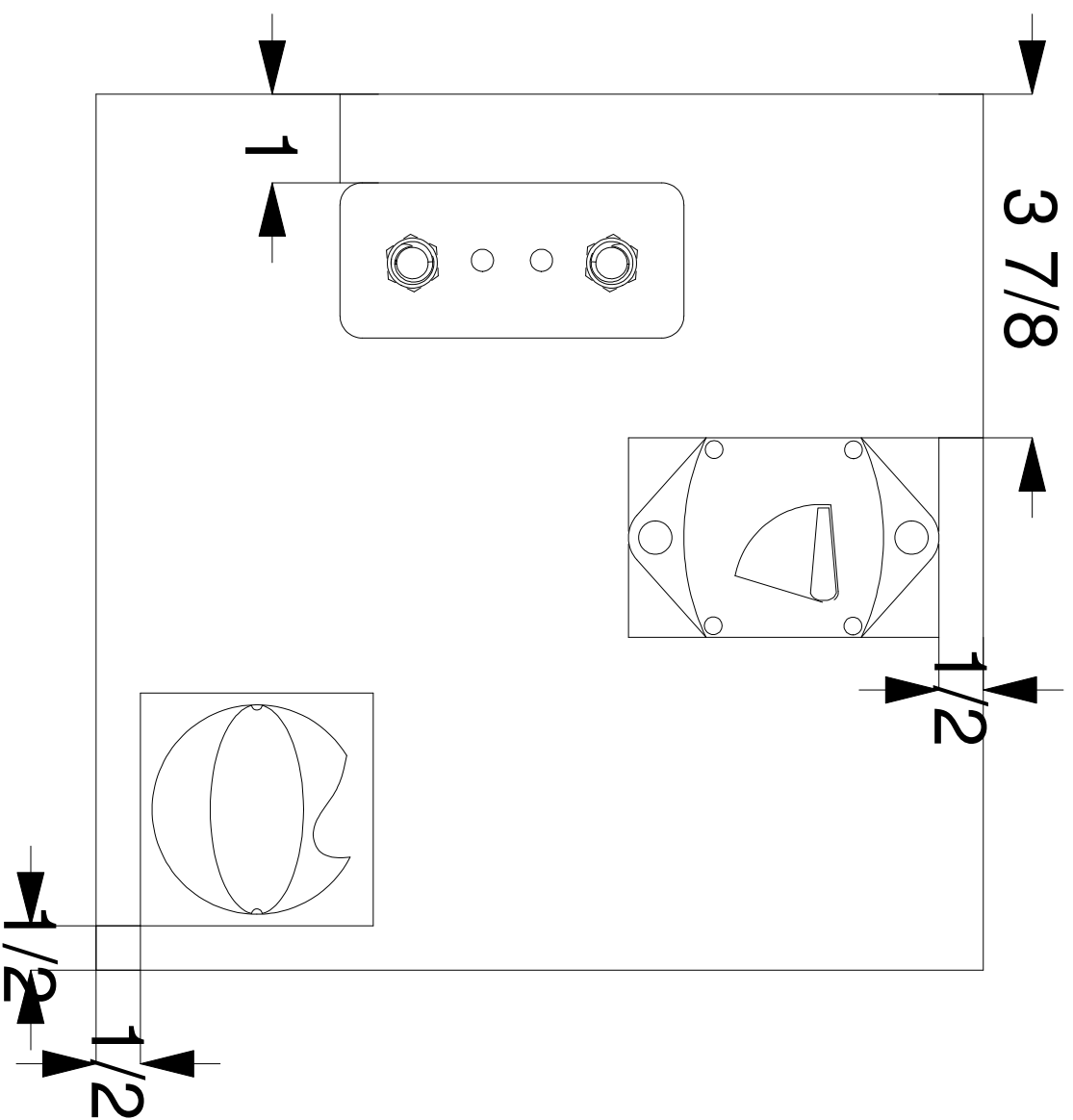

House
Main Breaker



Option:
Thrustor
Fuse

Option:
Thrustor
Battery
Switch

REV	REVISION DESCRIPTION	VAM	MJ	9/27/17
A	Changed Dimensions of Board and Components	DR. BY	APP. BY	REV. DATE

REGAL MARINE INDUSTRIES
2400 LETHBRIDGE DRIVE
ORLANDO, FLORIDA 32809
TEL: (407) 351-4360

ALL RIGHTS RESERVED

DRAWING TITLE:
33 SAV (VX) Bow Thruster Board

DATE:	REVISION:	PAGE:
5/18/2017	A	1 OF 1
DRAWN BY: CVL	APPROVED BY: Mark J.	DWG. NO.: EVX22S

PROPRIETARY AND CONFIDENTIAL:
THE INFORMATION CONTAINED IN THIS DRAWING IS THE SOLE PROPERTY OF REGAL MARINE INDUSTRIES. ANY REPRODUCTION IN PART OR AS WHOLE WITHOUT THE WRITTEN PERMISSION OF REGAL MARINE INDUSTRIES IS PROHIBITED.